



MAESTRO 3.0

PROFESSIONAL
ARCHITECTURAL
LIGHTING

i-LèD

MAESTRO 3.0

PROFESSIONAL ARCHITECTURAL LIGHTING

linealightgroup

LINEA LIGHT GROUP

Depuis sa création en 1985 et jusqu'à ce jour, Linea Light Group s'est agrandie pour devenir et être considérée comme l'un des acteurs majeurs de l'éclairage technique et décoratif. Ces deux esprits cohabitent et se nourrissent mutuellement, grâce à la recherche formelle du Groupe constante et continue dans le domaine technologique.

Avec l'acquisition récente de la marque historique Stilonovo, célèbre pour ses produits innovants et expérimentaux, l'offre décorative de Linea Light Group s'est enrichie. Nous avons hérité de Stilonovo des objets lumineux dessinés par Ettore Sottsass, De Pas D'Urbino Lomazzi, sans oublier Joe Colombo, et à ces icônes nous avons ajouté de nouvelles lampes développées entièrement dans notre entreprise. Une telle acquisition complète la collection Décorative avec des produits d'une grande personnalité et à la forte présence scénique.

En même temps, Linea Light Group maintient sa présence de leadership dans le domaine de l'éclairage professionnel avec la marque I-Lèd perçue comme des plus innovantes pour l'éclairage à LED. Depuis 2019, nous nous sommes imposés dans le segment de l'éclairage industriel et urbain avec des produits dédiés, en renforçant notre présence sur le marché de l'éclairage technique grâce à des produits efficaces et innovants. Nos catalogues, très complets, nous permettent d'être présents et actifs sur des canaux de vente diversifiés, et de fournir de manière optimale et rapide chacun de nos clients. Précision, rapidité et fiabilité sont les caractères qui définissent depuis toujours Linea Light Group.



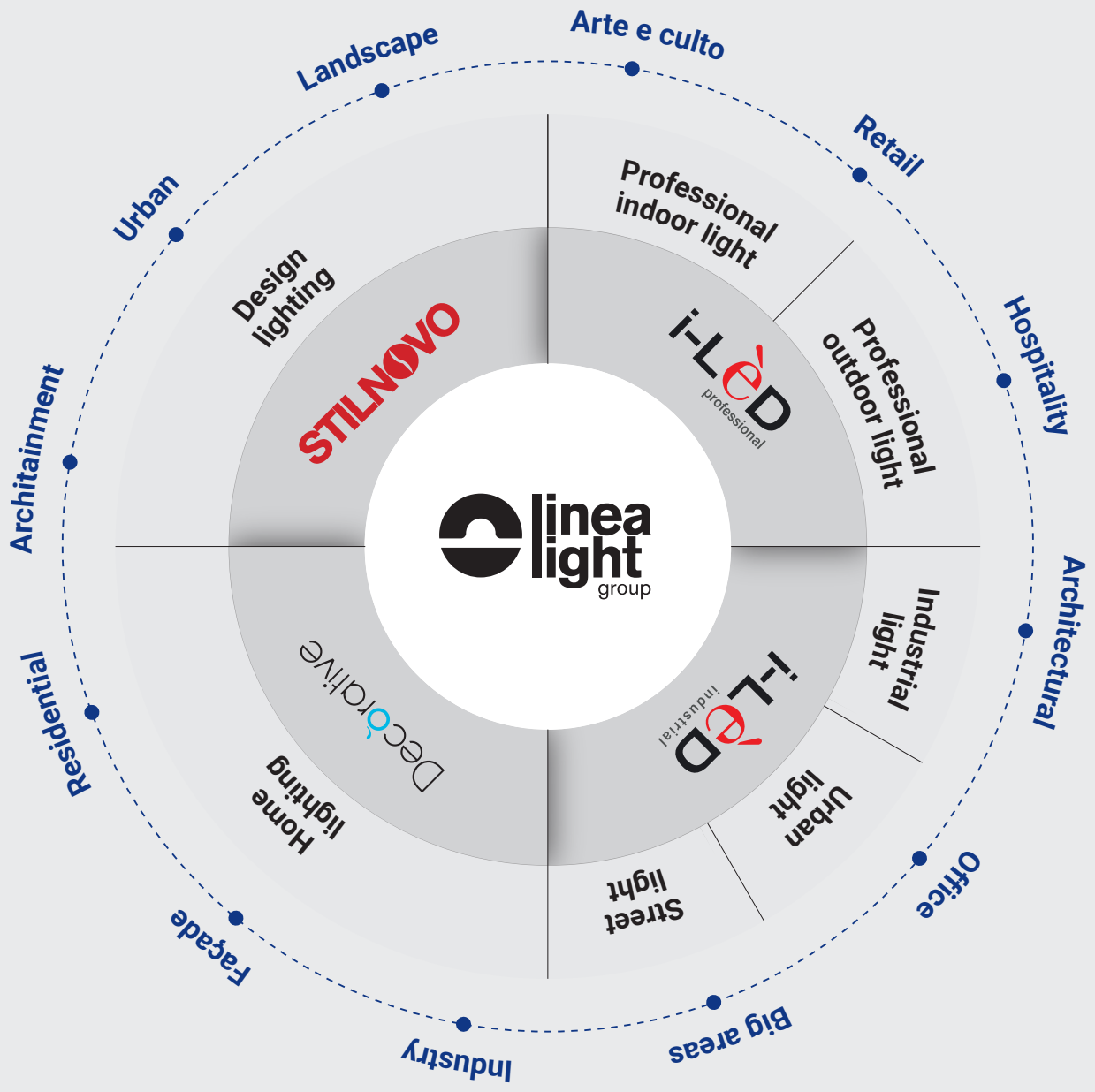



SOCIÉTÉ INTERNATIONALE

Trois plateformes de production pour garantir un service mondial sur mesure à disposition des professionnels de l'éclairage.



-  Headquarter
-  Hub-Branches
-  Branches



Linea Light Group est un ensemble unique d'entreprises spécialisées dans les différents domaines du monde de l'éclairage, à la fois indépendantes et coordonnées. Une formule qui permet de créer des solutions complètes et originales, dans tous les contextes, depuis les systèmes intégrés pour grands bâtiments résidentiels ou publics jusqu'à l'éclairage extérieur ou subaquatique, depuis les environnements domestiques jusqu'aux espaces commerciaux, industriels, institutionnels et collectifs.

Linea Light Group s'est distingué par une approche du marché centrée sur les particularités et les besoins des partenaires locaux dans une perspective de type « penser globalement, agir localement », axée sur le rapprochement des zones et sur le service de qualité sur des distances réduites. Aujourd'hui, Linea Light Group est une société à forte présence internationale, dotée d'un réseau étendu, toujours aux côtés de ses partenaires, où que soient leurs projets.





linea
light
group

DURABILITÉ, QUALITÉ ET GARANTIE

Linea Light Group investit, et continue à observer une philosophie de respect de l'environnement quels que soient les services de la société, bureaux, production, et entrepôt. Depuis de nombreuses années, la société consacre des ressources à la limitation de son impact environnemental dans différentes activités grâce à des mesures en faveur du développement durable, telles que l'emploi d'énergies renouvelables presque entièrement autoproduites, la réduction des consommations et des émissions de CO₂, le tri et le recyclage des déchets de la production et des matières premières. Ces activités ne sont qu'un exemple parmi les activités écologiques durables que nous menons pour améliorer notre modèle économique vertueux. La destruction des déchets et leur recyclage sont deux points importants pour le Groupe : tous les déchets de la société sont détruits correctement, en suivant des normes précises et des protocoles rigides afin d'éviter toute dispersion dans les sols et les cours d'eau. C'est pourquoi, notre Groupe est constamment tourné vers la recherche et le développement de solutions pouvant réduire au minimum l'impact sur l'environnement.

Par exemple, l'utilisation de nouvelles huiles biologiques comme lubrifiants pour les machines de la production, telles que les CNC et les lignes de découpe. Pour ces instruments, nous utilisons des lubrifiants réfrigérants d'origine végétale (à base d'éthers de synthèse) sans huile minérale, ni chlore, amines secondaires, conservateurs libérateurs de formaldéhyde, de bore et leurs dérivants. À la fin du cycle de production les huiles usées sont récupérées et recyclées par des sociétés spécialisées et certifiées. En outre, nous sommes attentifs à d'autres aspects qui nous ont amené à réduire constamment notre impact sur l'environnement. En premier lieu, le remplacement des machines obsolètes et énergivores par de nouveaux équipements plus efficaces et donc plus efficaces. En second lieu, l'emploi de filtres à air spéciaux qui réduisent considérablement les émissions des machines de découpe au laser. Les postes de travail dans chaque service ont également été étudiés pour réduire et optimiser la consommation d'énergie.







MADE IN ITALY

Linea Light Group est une entreprise manufacturière qui, parallèlement à sa capacité industrielle, a su conserver cette part d'artisanat qui a toujours caractérisé le Made in Italy. Depuis la conception et la création jusqu'à l'assemblage, nos produits allient haute technologie, recherche et savoir-faire, une recette qui a rendu les entreprises italiennes uniques au monde.

Aux côtés des machines traditionnelles, nous avons ajouté des technologies nouvelles et performantes qui nous permettent de réaliser en interne tous les procédés qui ont rendu nos produits uniques. C'est notamment le cas de la machine de micro-gravure laser sur PMMA, indispensable à la technologie OptiLight®.

Linea Light Group s'est équipé de systèmes d'imperméabilisation des luminaires à immersion permanente, pour assurer une étanchéité parfaite des diffuseurs, et de soudage par ultrasons, installés dans des ateliers dédiés. Nous allons au-delà de la construction : un produit parfait doit également être testé et certifié ; c'est pourquoi Linea Light Group possède son propre laboratoire interne. Ce dernier permet d'effectuer tous les tests de qualité, tels que les tests de résistance à la chaleur, aux chocs ou au passage de véhicules, ou encore les tests IP pour les produits d'éclairage subaquatique.



Autostore headquarter, Treviso, Italy



CONCEPTION

La connaissance du produit, de toutes ses composantes et minuteries, de la relation entre chaque partie mécanique et électronique des optiques, permet de concevoir des solutions pensées pour le client.

TEST

Les zones de test utilisent des machines pour tester la résistance à la chaleur, aux chocs, vérifier l'IP, la praticabilité des Uplight, la résistance des matériaux à la corrosion et aux milieux salins, etc.

Les spécifications des instruments permettent de tester les composants électroniques contre les surtensions et les décharges électrostatiques, d'obtenir des courbes photométriques précises ou de vérifier la fiabilité des protocoles DALI et Bluetooth.



Test de résistance aux basses températures -30°



Test IP

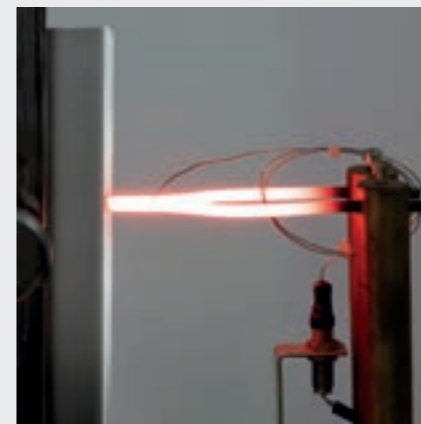

Méthode d'essai d'inflammabilité

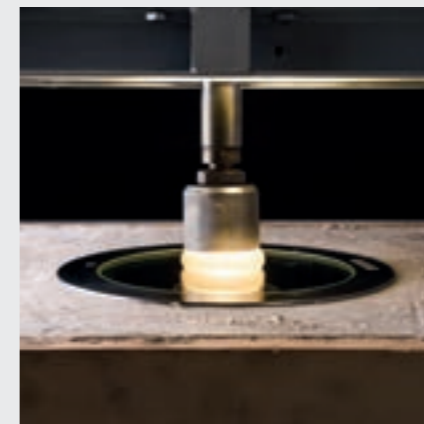

Test IK



Siliconage du diffuseur.

PRODUCTION

Linea Light Group adopte un modèle industriel qui inclut, dans les différentes phases qui composent la production, une approche manufacturière pour la création et l'assemblage des produits. Le savoir-faire typique de l'artisan, transformé en une unité de production moderne.

LOGISTIQUE

Le nouveau magasin d'entreposage, au cœur du site de production de Vazzola (TV), atteint globalement les 24 000 m² pour une capacité de stockage de 21 000 unités de charge équivalentes à environ 420 000 kg.



Soudage par ultrasons.



Usinage CNC



Machine pour la micro-gravure laser du PMMA.

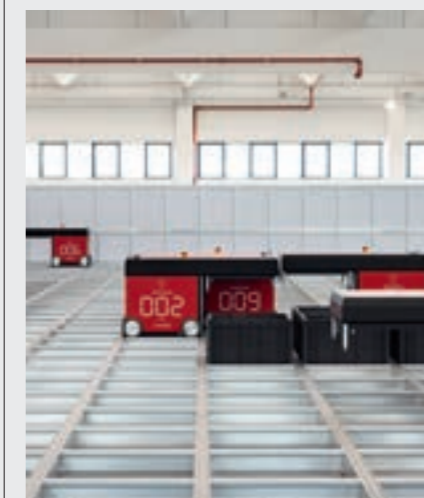

10 robots plug-and-play à haute efficacité d'un poids de seulement 150 kg chacun, et dotés d'un système de récupération de l'énergie au freinage, garantissent une consommation énergétique optimisée. Les postes de travail sont aussi étudiés pour réduire la consommation d'énergie.

CONCEPTION COMPLÈTE

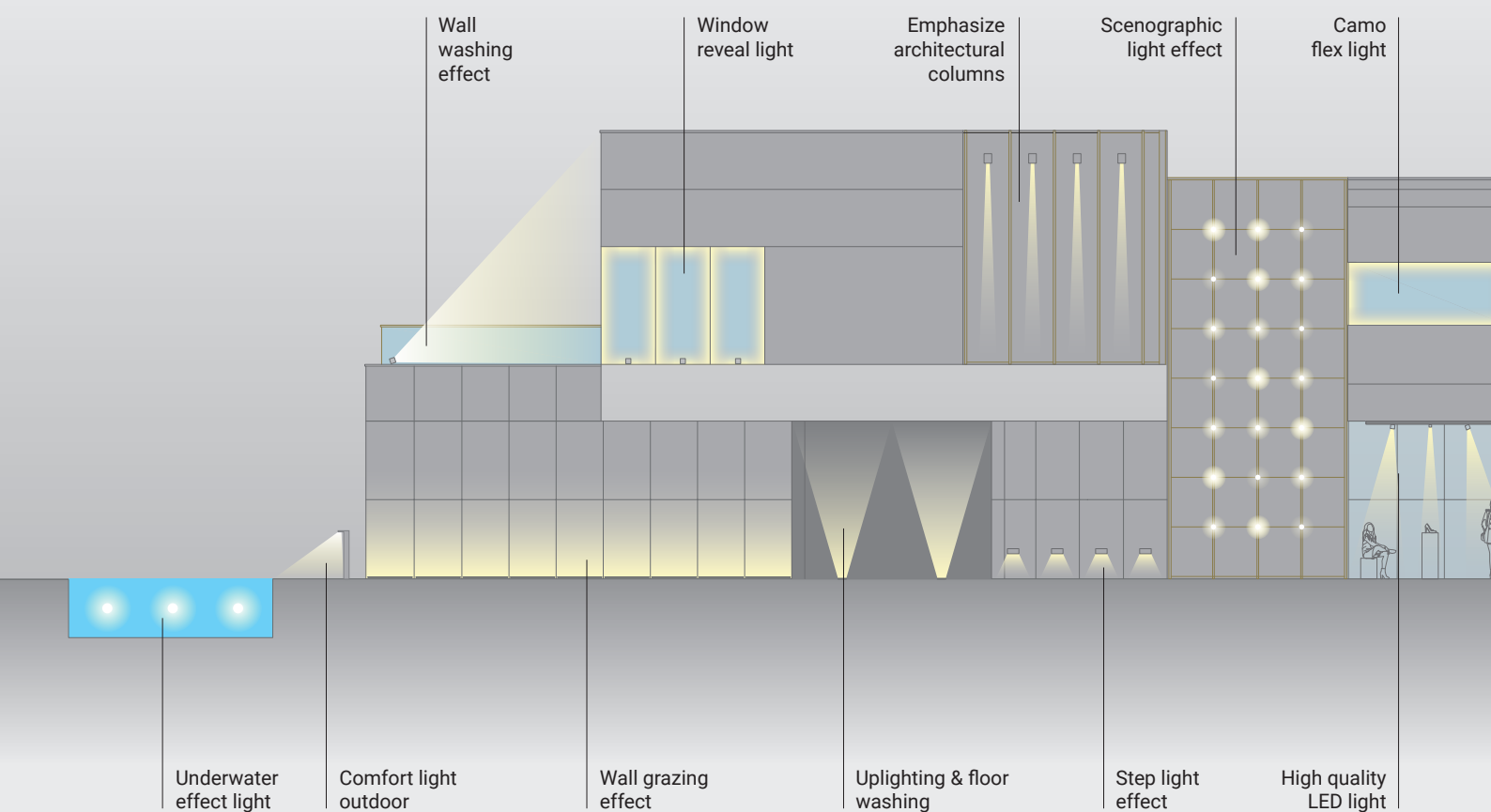

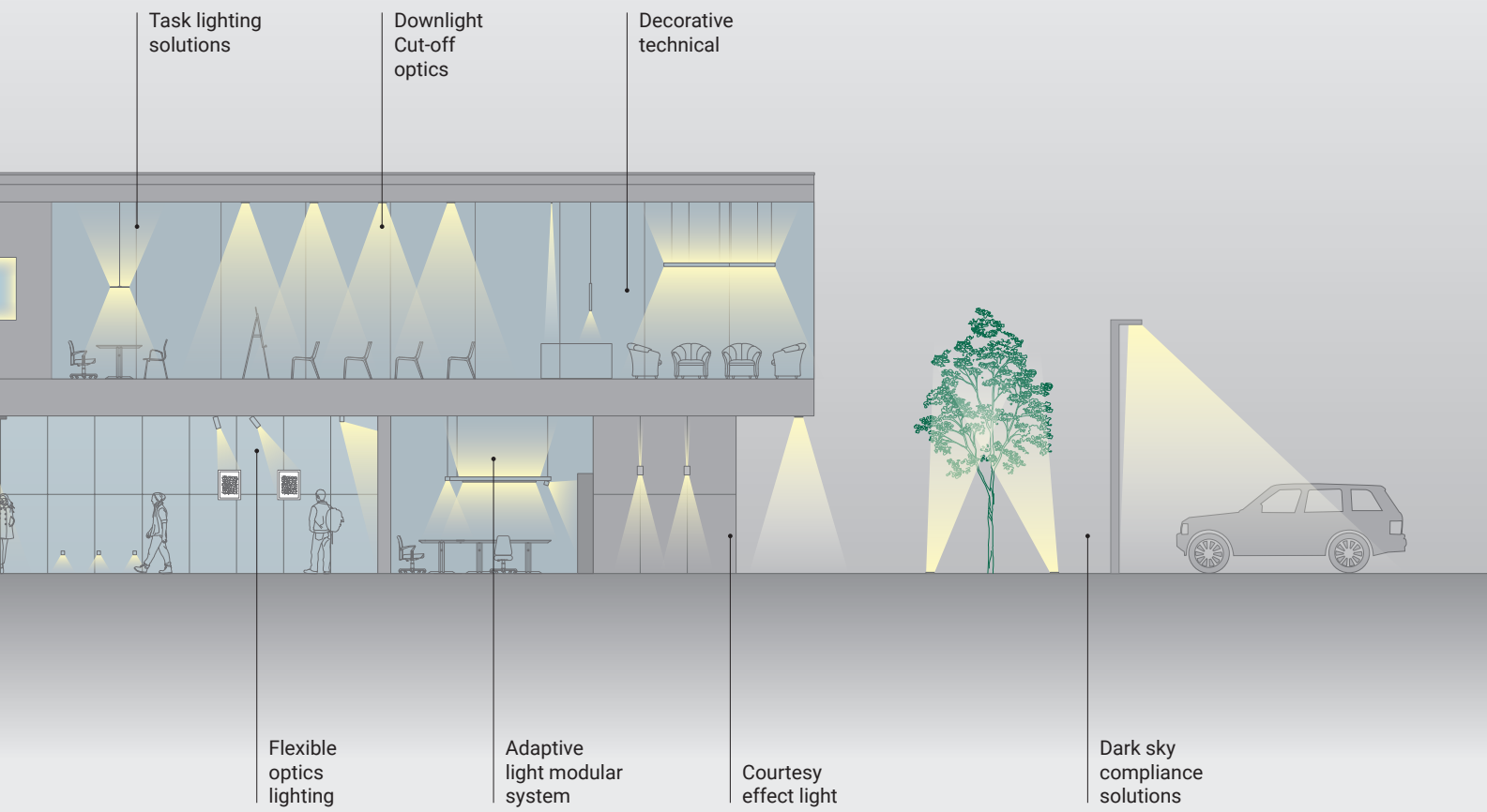

SOLUTIONS POUR CHAQUE CATÉGORIE DE PROJET

Avec plus de 40 000 codes produit, Linea Light Group parvient à satisfaire toutes les demandes du Marché global, garantissant et livrant des appareils conçus pour tous les types d'habitat. Son vaste réseau de vente et ses 15 sièges à travers le monde ont permis à l'entreprise de se développer jusqu'à devenir une référence en matière d'éclairage, parmi les plus connues et appréciées des professionnels. Notre section I-Lèd couvre aussi bien le domaine du divertissement que l'architecture, l'hôtellerie, le retail ou encore les espaces résidentiels.



Architainment

Linea Light Group a conçu des produits de façon à satisfaire au mieux les demandes du marché du Divertissement, même les plus particulières, de façon à faire de la lumière un élément scénographique, au-delà de son aspect fonctionnel. Grâce à ses appareils personnalisés et ses protocoles de gestion dédiés, l'entreprise est également devenue une référence dans ce secteur. Les solutions d'éclairage technique I-Lèd mettent en valeur les détails et les formes, rendant les couleurs des espaces plus nettes et plus vives.

Damac Tower, UAE



Art et culte

I-Lèd accompagne depuis toujours Linea Light Group dans ses projets les plus stimulants, notamment ceux dont l'objectif est d'éclairer les espaces d'art et les lieux de culte. Pour éclairer l'Art comme il se doit, des appareils hautement performants sont nécessaires, ainsi que des spots lumineux à LED capables d'exalter les formes et les couleurs. Nos spots lumineux ont été conçus pour éclairer de façon appropriée les fresques et les œuvres d'art, dans le respect de l'artiste et de son travail. La grande polyvalence de nos solutions d'éclairage technique facilite la projection des lumières en fonction des divers moments de la liturgie. Nos produits étant pratiquement invisibles, il est possible d'illuminer les architectures sacrées de façon discrète et efficace.

Museum des Arts Décoratifs, France



Architecture

I-Lèd, collection complète d'appareils techniques pour la projection de lumières d'architecture à l'intérieur comme à l'extérieur, offre à tout concepteur des produits incluant des sources lumineuses et une technologie en mesure de satisfaire les clients les plus exigeants. Profils linéaires, projecteurs montants et descendants aux dimensions toujours plus réduites et aux excellentes performances, permettent de faire face aux situations les plus complexes et les plus délicates. Avec I-Lèd, l'architecture trouve une nouvelle forme d'expression, capable d'exalter détails et matière.

Vida residence, UAE



Hôtellerie

Nos produits dédiés à l'hôtellerie transforment hôtels, complexes touristiques et restaurants en lieux magiques où faire l'expérience de la haute cuisine, du bien-être et de la détente.

Grâce à des éléments invisibles, dont l'éclairage s'intègre parfaitement dans l'architecture, Linea Light Group réussit à créer l'atmosphère voulue à l'intérieur des espaces, en équilibrant parfaitement ombres et lumières.

I-Lèd propose des solutions d'éclairage technique qui respectent les besoins des différentes zones à éclairer, avec des produits aux couleurs parfaites, offrant un excellent confort visuel.

Hard Rock Hotel, Spain



Bureau

Le domaine du Bureau contemporain est un mélange fonctionnel d'open space et de closed space. Nos produits I-Lèd allient puissance, confort visuel et contrôle des éclairages, et grâce à leur grande polyvalence ils répondent parfaitement à toutes les exigences des clients. Nos systèmes suspendus, encastrés ou modulaires comprennent des spots conçus pour éviter de fatiguer la vue devant les écrans vidéo, pour un éclairage commode, favorisant la productivité et la continuité du travail, stimulant la créativité et l'opérativité.

NGC Medical HQ, Italy



Commerce

Tout projet de commerce a un éclairage propre, qui doit mettre en forme et en valeur les produits exposés. Nous avons conçu des spots à LED aux caractéristiques technologiques idéales pour éclairer n'importe quel espace, des petits magasins aux grands centres commerciaux. Nos techniciens travaillent toujours avec nos concepteurs afin de résoudre les difficultés et satisfaire les demandes particulières qui leur sont soumises. Linea Light Group propose aux architectes et aux concepteurs d'éclairages des produits de précision, modulables selon les exigences d'exposition. Ceci afin que le client fasse une expérience d'achat plus fonctionnelle et en toute conscience.

Timinis Store, Cyprus



Landscape

L'éclairage des paysages, naturels ou urbains, s'est transformé et a évolué. Auparavant purement fonctionnel, l'éclairage a acquis des caractéristiques esthétiques importantes. Dehors, la vie est devenue plus agréable et plus sûre. La technologie LED a donné plus de liberté au concepteur, et favorisé une plus grande personnalisation des produits et des espaces. La LED a permis à Linea Light Group de construire des appareils performants, et aux professionnels de mettre en œuvre toutes leurs idées d'éclairage. Avec un éclairage adéquat, un jardin ou une rue peuvent être fréquentés la nuit, en offrant davantage de visibilité et de sécurité.

Four Season Hotel, Greece



Résidentiel

Pour les espaces résidentiels, I-Lèd offre une large gamme de systèmes suspendus ou encastrés, de plafonniers et d'éclairages au sol, en mesure de satisfaire les demandes les plus exigeantes. Ces éléments lumineux allient professionnalisme et design et sont à la fois performants et décoratifs.

Ces collections sont disponibles avec différentes finitions et températures de couleur, s'adaptant à tous les environnements domestiques intérieurs ou extérieurs, ainsi qu'à tous les styles de logement.

Private House, Italy



Industrie

La lumière sur le lieu de travail, et plus particulièrement dans le secteur industriel, est fondamentale pour le bien-être des gens. Travailler avec un éclairage approprié et un confort visuel adapté permet d'améliorer l'efficacité, l'opérativité et la productivité. Grâce à la protection IP69, aux protocoles les plus récents et à des matériaux ultra-technologiques tels que les nanopolymères, Linea Light Group offre des solutions résistantes et durables. En effet, nos appareils I-Lèd peuvent être également utilisés dans les secteurs industriels les plus extrêmes, notamment les Atex, en toute sécurité et dans le respect des normes.

Zeche Zollverein, Germany



Éclairage urbain

Éclairer chaque recoin d'une ville de façon appropriée, selon la hiérarchie voulue, permet notamment de mieux la protéger. Des rues aux jardins, en passant par les bâtiments historiques, chacun de nos éclairage d'objets urbains répond à l'ensemble des exigences esthétiques et normatives requises par son environnement. Chez Linea Light Group, nous concevons et développons chaque détail technologique, esthétique et électronique de ses appareils I-Lèd, des fiches ou cartes électroniques aux éléments optiques. Chez Linea Light Group, nous créons des produits faits pour durer dans le temps, en garantissant le même niveau de prestations et de gestion de la technologie, de manière à satisfaire toutes les exigences des concepteurs.

Capricorn Bridge, Germany

CUSTOM

Linea Light, grâce à ses 35 ans d'expérience, sait répondre à toutes les exigences des designers en leur apportant expertise et créativité. Notre histoire nous a permis de nous tourner vers l'avenir en étant à l'écoute, et en développant des solutions uniques. Linea Light a été l'une des premières entreprises à utiliser et à comprendre le grand potentiel de la LED, une technologie qui offre des possibilités infinies de personnalisation.

Linea Light Group met à la disposition de tous les professionnels un service à la carte. La personnalisation de l'un de nos produits suit un cheminement précis. Cette méthode nous permet de garantir au maximum la réalisation et la fiabilité du projet selon le type d'appareil. Toutes les demandes que nous recevons sont soigneusement évaluées et testées pour estimer la possibilité de réalisation et les quantités utiles au projet. Ces éléments sont importants pour une gestion correcte du temps et des coûts, deux facteurs clés de réussite de la conception.

En suivant ces indications, nous avons mis au point trois niveaux de personnalisation pour répondre aux demandes des concepteurs.

Adapter les produits du catalogue:

Nous pouvons adapter les produits du catalogue selon les finitions et les dimensions que vous souhaitez. Vous choisissez l'appareil, nous le fabriquons selon vos spécifications.

Personnaliser les sources de lumière:

Nous pouvons équiper les produits avec des sources et des prestations personnalisées. Éclairer un espace de manière adéquate est essentiel, et grâce à nos compétences vous pouvez façonner votre éclairage.

Concevoir des produits uniques:

Nous pouvons réaliser un produit en suivant votre idée d'éclairage et créer un appareil lumineux unique et exclusif.

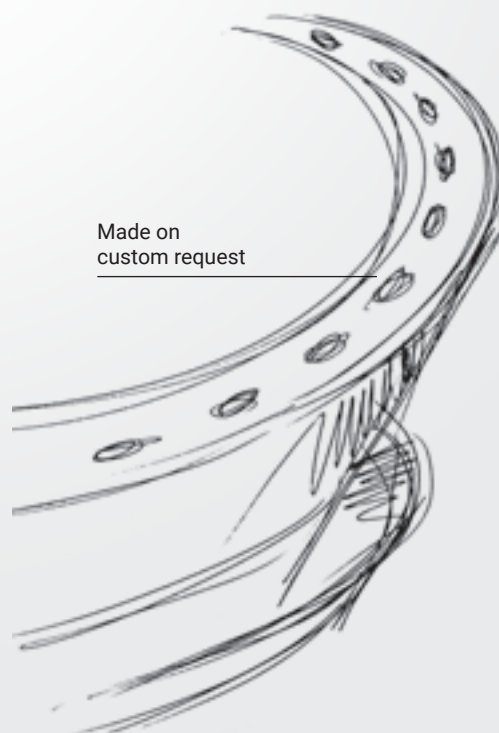



CONNECTÉS AU FUTUR

Le **Bluetooth Mesh** est la dernière étape de connexion rapide des nœuds sans fil. C'est une technologie fondamentalement différente de tous les autres systèmes de réseau Wifi mis en œuvre pour le contrôle de l'éclairage. Basé sur une **norme internationale** et développé par Bluetooth SIG (Special Interest Group), le réseau Mesh permet **l'interopérabilité** entre des dispositifs de différents fabricants, et d'utiliser nos produits sur n'importe quel réseau de ce type. Bluetooth 5.0 est la version de la norme la plus avancée sur le marché, facilitant la présence simultanée de plusieurs appareils dans une même pièce grâce à une réduction radicale des interférences par rapport aux versions précédentes.

En profitant d'une plus large bande, Bluetooth 5.0 enregistre une augmentation de la capacité de transfert des données et fournit une couverture plus large et stable en maintenant une faible consommation d'énergie.



Stabilité, fiabilité et sécurité, sont les trois principaux avantages d'utilisation du nouveau protocole adopté par Linea Light Group. **Stabilité**, une panne sur cet élément ne compromet pas le fonctionnement du reste du réseau. **Fiabilité**, il est facile de gérer et d'inspecter chaque nœud du réseau. **Sécurité**, des fonctionnalités avancées ont été ajoutées dans la pile du protocole.

Technology Partner

SILVAIR

Linea Light Group a choisi Silvoir comme solution de contrôle et de gestion du système. Il est possible de configurer son propre réseau en quelques passages simples (pag 920), et à travers l'application Silvoir de configurer le paramétrage des installations dans des environnements multifonction, espaces de bureaux, GDO, locaux publics, zones résidentielles.

Suivi constant et de n'importe quel lieu

Grâce au service API en cloud fourni par Silvoir, l'interfaçage avec des systèmes de contrôle BMS ou de suivi par des tierces parties est possible, en facilitant le contrôle de l'énergie, l'état des consommations, le relevé de présence dans les pièces afin de réguler la lumière de l'installation en fonction de l'activité et du fonctionnement des espaces.

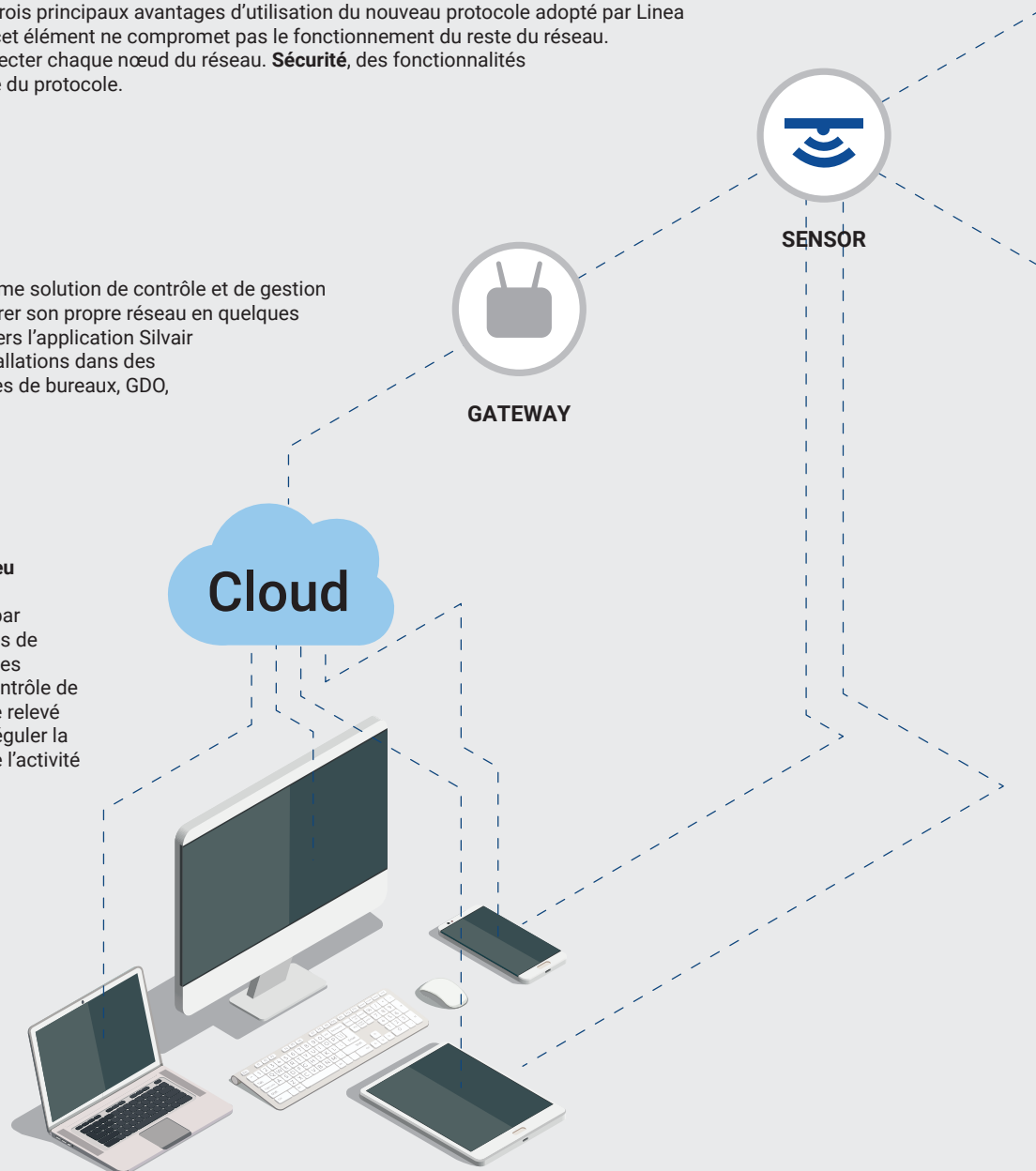

Scalabilité du système

Chaque point du réseau fonctionne comme une passerelle pour le point suivant, en simplifiant le déploiement et la mise à jour du réseau. L'extraordinaire flexibilité de cette technologie permet d'installer les appareils à une distance maximale de 25 mètres l'un de l'autre dans des conditions idéales.

Facile à configurer

Quelle que soit l'étendue du réseau Mesh, il peut être géré avec une grande précision en facilitant la programmation, la mise en scène des scénarios, et en simplifiant les opérations de maintenance. Le protocole Bluetooth Mesh présente en outre deux avantages majeurs : il n'est pas dépassé malgré les avancées technologiques, et bénéficie d'un service informatique en nuage performant pour le contrôle à distance de l'état du réseau.







TOUTES LES INFORMATIONS À PORTÉE DE CLIC

Toujours et partout, le site est un conteneur d'informations et d'actualités sur le monde entier de Linea Light Group. Un outil constamment mis à jour où il est possible de trouver des références de projets, des articles de formation, mais aussi des systèmes de recherche de codes avancés, ainsi que des solutions de «comparaison» pour comparer des familles de produits. Bref, tout ce dont vous avez besoin pour le développement de votre projet!



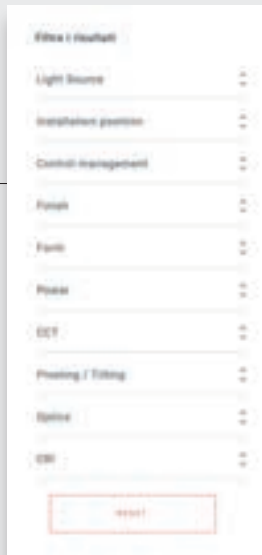

Recherche par l'application de filtres

Dans toutes les pages de famille produit, il existe des filtres latéraux qui guident la recherche en insérant les caractéristiques (type de source, positions des installations, gestion du contrôle, etc.). Vous pouvez utiliser cette fonction pour sélectionner le produit désiré.



Si vous êtes indécis, comparez les produits!

Vous pouvez comparer jusqu'à 5 produits simplement en positionnant le curseur de la souris sur les images du produit et en cliquant sur l'icône en haut à droite « Ajouter pour comparer ». Une coche bleue vous signale que les produits ont été ajoutés pour comparaison.



Orma



Orma_AB

Compare

Le bouton bleu « Comparer » ancré sur la droite de l'écran, une fois cliqué, ouvrira une page de comparaison entre les familles de produit sélectionnées.



Configurer votre code

Utilisez le configurateur de code sur chaque page produit. Cet instrument vous aide à trouver le code exact en fonction de vos critères.





HOW TO READ PRODUCTS

Vos_R | Downlight | powerLED 1,5 W 500 mA

Nom du produit | Chapitre | Typologie L.E.D. | Puissance | Fonctionnalités électroniques



Pictogrammes
Comment lire les symboles voir la page 968

Émission lumineuse

Image du produit avec dessin technique aux cotes, et informations sur le trou à percer au plafond

Finition	Code produit	Accessoires intérieurs	Indice de rendu de couleur
	CRI 92	CRI 92 HC	CRI 80
White	90638	90646	90416
Black	90639	90647	90417
			CRI 80 HC
			90644
			90645

	Cct	Im-S - D CRI 92	Im-S - D CRI 80	Optic
M	2700	395 - 163	490 - 202	15 Spot (15°)
W	3000	423 - 174	490 - 202	30 Flood (29°)
N	4000	456 - 188	529 - 218	60 Wide Flood (50°)

Code et température de couleur | **Im-S** Flux Source | **Im-D** Flux Sortant | Code Optique | Angle d'ouverture du faisceau lumineux

Le flux sortant (**Im-D**) est détecté en prenant comme référence une seule optique et une seule finition. Pour en savoir plus, veuillez consulter les fiches techniques sur le site: linealight.com

Comment configurer un produit: guide de la composition du code final

$$90638 + M + 60 = 90638M60$$

1^{er} code produit | 2^e code température | 3^e code optique | Composition du code final

Code Électronique	Informations sur l'électronique et les dimensions	Composition du code pour convertisseur		
89145	99375	99708	99711	+ driver 24V DC
ON/OFF 1 art. p 138 x l 22 x h 21	ON/OFF 2-3 art. p 138 x l 22 x h 21	0/1-10V converter 1 art. p 138 x l 22 x h 21	DALI converter 1 art. p 138 x l 22 x h 21	99374 75W 99331 150W

Recessed casing Pag. 21

99847 H. 28 - Ø. 41

Code boîtier encastrable | Taille boîtier encastrable

Ves_R | Downlight | powerLED 1,5 W DC 500 mA



	CRI 92	CRI 80
Reference	90622	90408
Accessories	90623	90409

	Cut	Im S - D CRI 92	Im S - D CRI 80	Optic
M	2700	124 - 79	187 - 104	20 Spot (22°)
W	3000	153 - 85	199 - 110	35 Flood (34°)
N	4000	-	213 - 118	-

Electronics

99195	99146	99377	99709	99712	+ driver 240 DC
28x27	28x27	28x27	28x28 (max. dim.)	28x28 (max. dim.)	99374 7500
1 - 1,4m	1 - 1,4m	1 - 1,4m	1 - 1,4m	1 - 1,4m	99375 1500
Ø 100 x 120 x 47	Ø 100 x 120 x 47	Ø 100 x 120 x 47	Ø 100 x 120 x 47	Ø 100 x 120 x 47	-

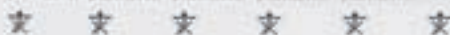

Ves_R | Downlight | powerLED 4 W DC 350 mA



	CRI 92	CRI 92 HC	CRI 80	CRI 80 HC
Reference	90638	90646	90416	90644
Accessories	90639	90647	90417	90645

	Cut	Im S - D CRI 92	Im S - D CRI 80	Optic
M	2700	395 - 163	490 - 202	15 Spot (15°)
W	3000	423 - 174	490 - 202	30 Flood (29°)
N	4000	458 - 188	529 - 218	60 W.Flood (30°)

Electronics

99145	99375	99708	99711	+ driver 24V DC
28x27	28x27	28x28 (max. dim.)	28x28 (max. dim.)	99374 7500
1,4m	1,4m	1,4m	1,4m	99375 1500
Ø 100 x 120 x 47	Ø 100 x 120 x 47	Ø 100 x 120 x 47	Ø 100 x 120 x 47	-



Recessed casing Pag. 21

99847 H, 28 - Ø, 41

Ves_R | Downlight | powerLED 2 W DC 630 mA



	CRI 92	CRI 92 HC	CRI 80	CRI 80 HC
Reference	90626	90634	90412	90632
Accessories	90627	90635	90413	90633

	Cut	Im S - D CRI 92	Im S - D CRI 80	Optic
M	2700	157 - 69	239 - 99	15 Spot (21°)
W	3000	179 - 78	233 - 102	30 Flood (28°)
N	4000	-	249 - 109	60 W.Flood (32°)

Electronics

99147	99376	99105	99710	99713	+ driver 240 DC
28x27	28x27	28x27	28x28 (max. dim.)	28x28 (max. dim.)	99374 7500
1 - 1,4m	1 - 1,4m	1 - 1,4m	1 - 1,4m	1 - 1,4m	99375 1500
Ø 100 x 120 x 47	Ø 100 x 120 x 47	Ø 100 x 120 x 47	Ø 100 x 120 x 47	Ø 100 x 120 x 47	-

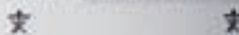

Recessed casing Pag. 21

99847 H, 28 - Ø, 41

Ves_R | Downlight | powerLED 6 W DC 500 mA

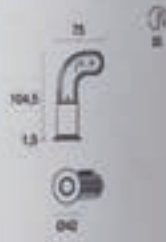

	CRI 92	CRI 92 HC	CRI 80	CRI 80 HC
Reference	90650	90658	90420	90656
Accessories	90651	90659	90421	90657

	Cut	Im S - D CRI 92	Im S - D CRI 80	Optic
M	2700	532 - 231	659 - 287	15 Spot (19°)
W	3000	569 - 248	659 - 287	30 Flood (30°)
N	4000	614 - 267	711 - 309	60 W.Flood (32°)

Electronics

99377	99106	99714	99715	+ driver 24V DC
28x27	28x27	28x28 (max. dim.)	28x28 (max. dim.)	99374 7500
1,4m	1,4m	1,4m	1,4m	99375 1500
Ø 100 x 120 x 47	Ø 100 x 120 x 47	Ø 100 x 120 x 47	Ø 100 x 120 x 47	-



Recessed casing Pag. 21

99848 H, 28 - Ø, 41

99650W30 / 99650W60 / 996420W30 / 996420W60



indoor range index

Downlights

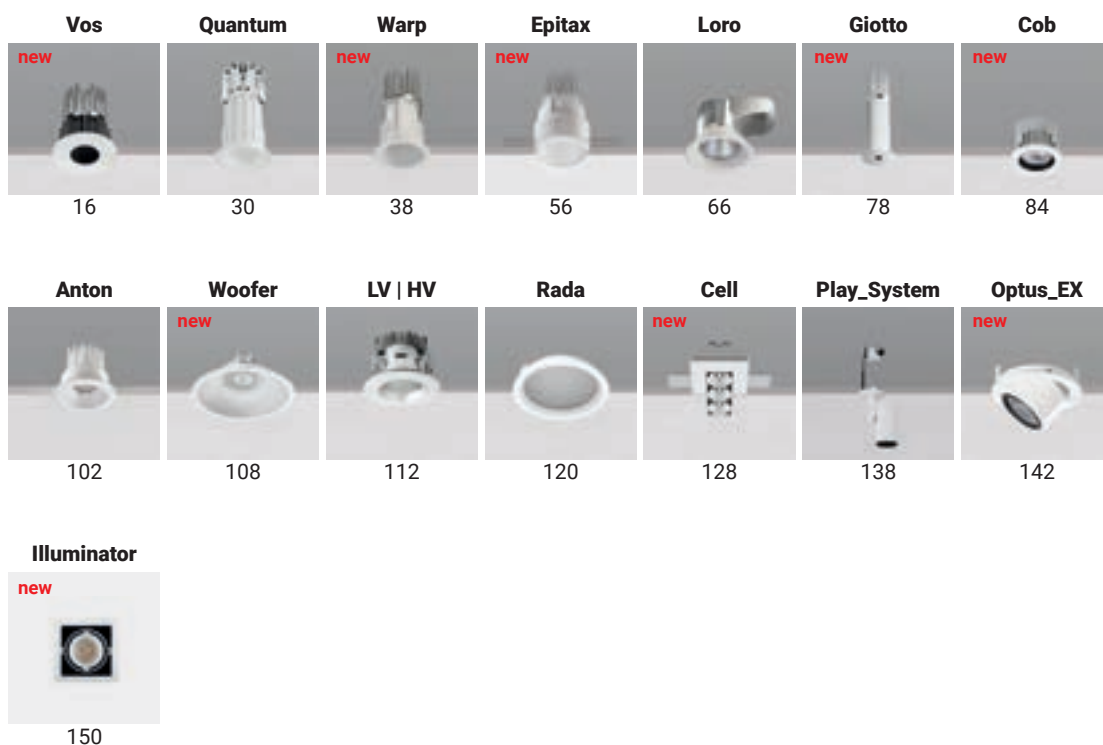

Projectors

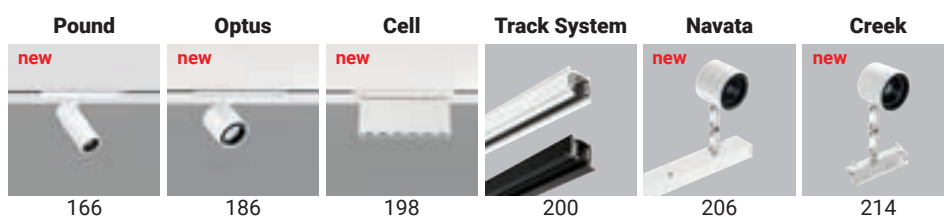

Ceiling

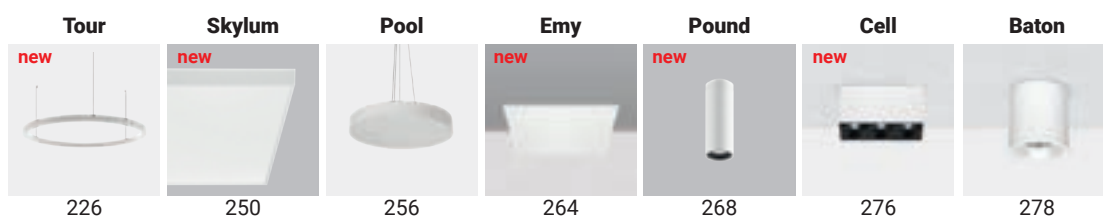

Linear systems

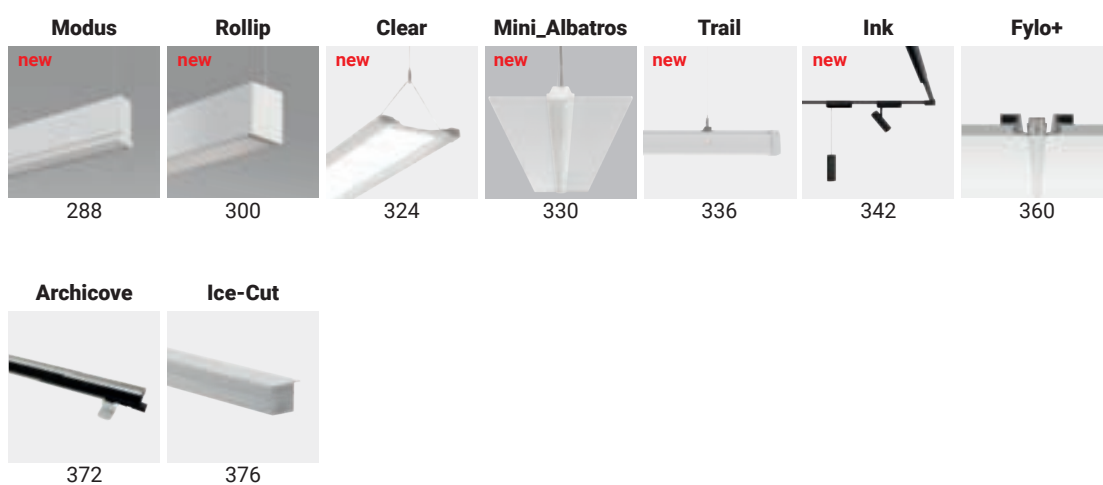

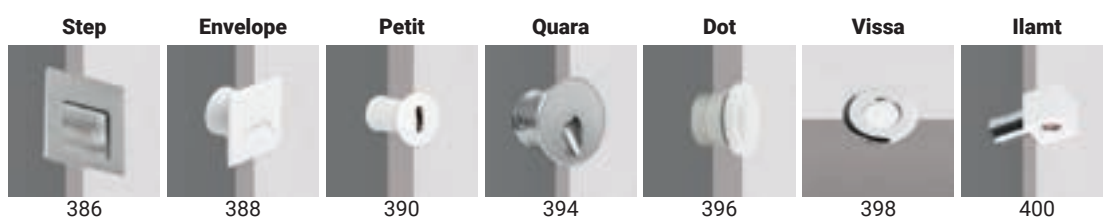
Path markers

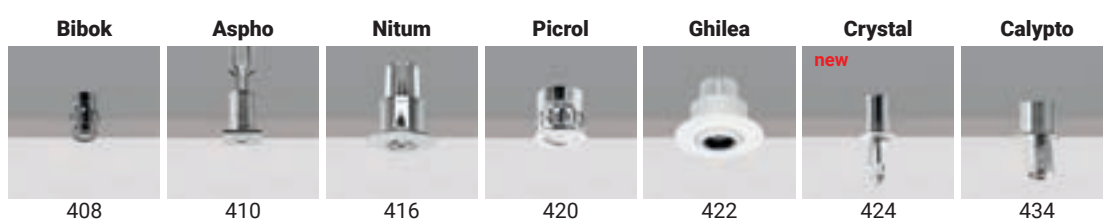
Small spotlights

Small projectors

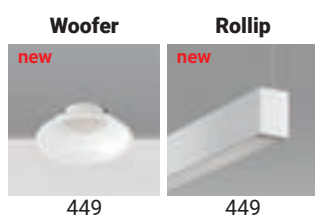
Environment care lighting

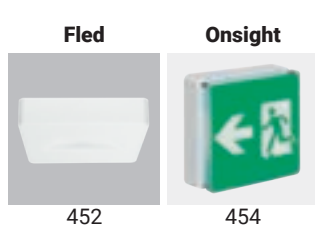
Emergency

outdoor range index

Ceiling lamps

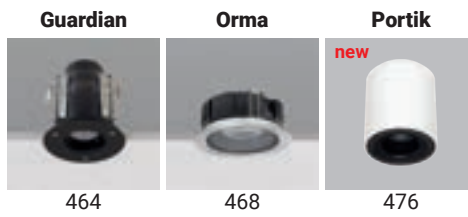

Wall lamps

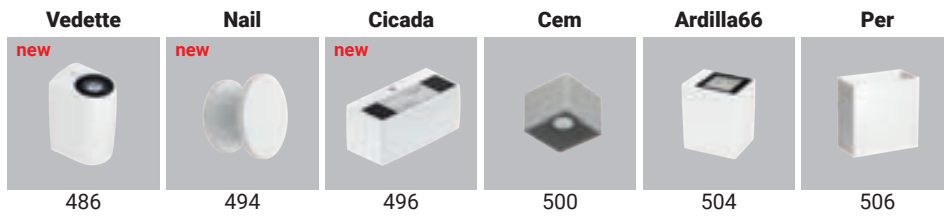

Wall path markers

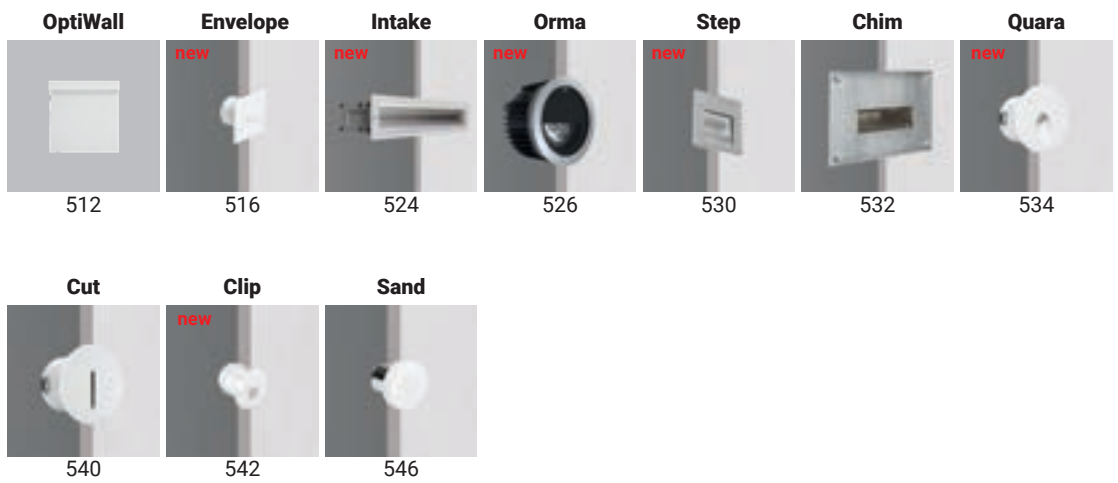

Uplights & inground lamps

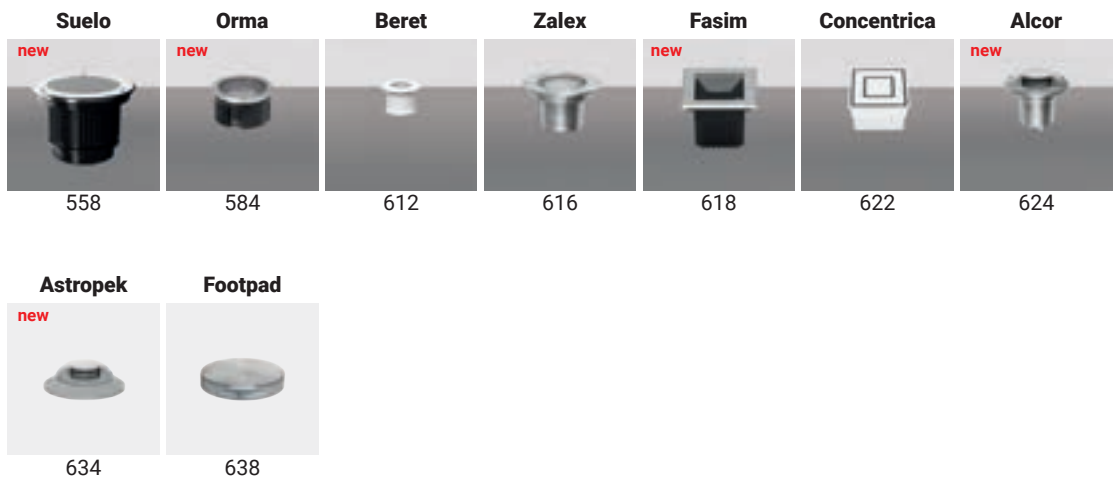

Bollards & poles

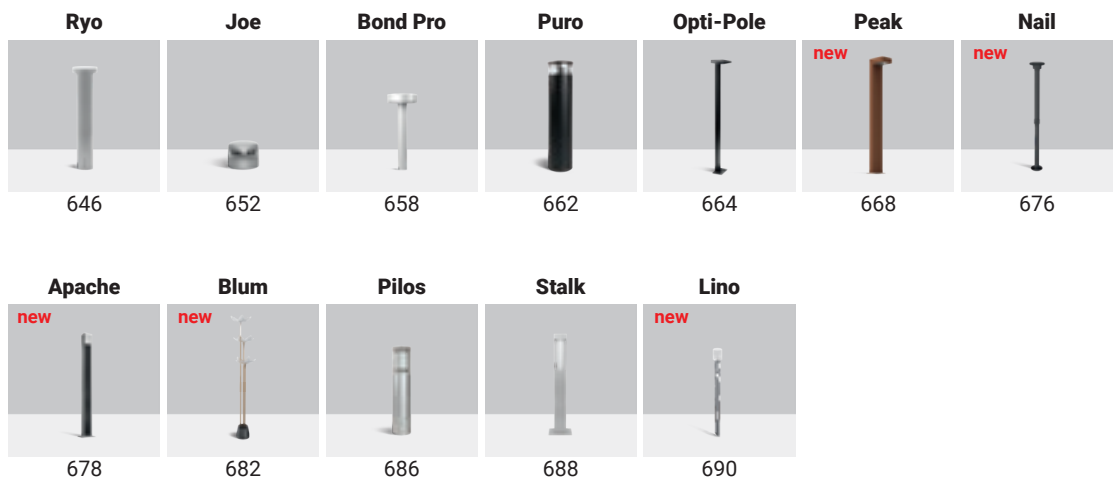

Linear light

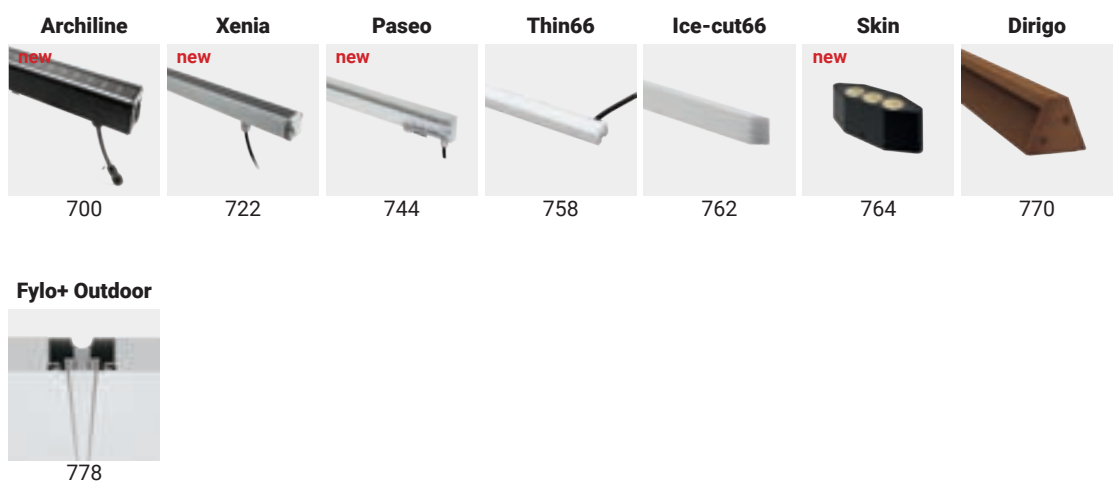

Accent lighting



outdoor range index

Light effects



Underwater



flex light range index

Flex light



electronics range index

Electronics

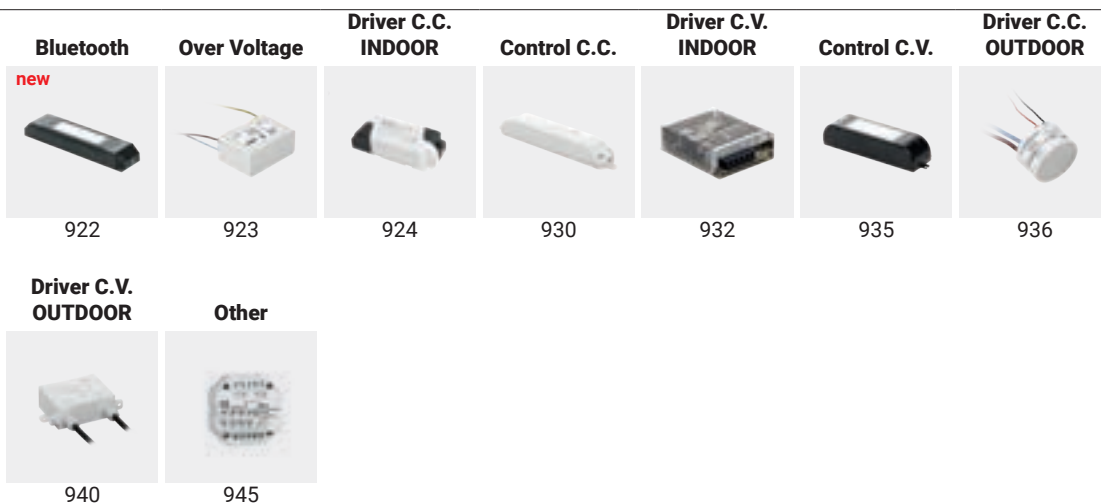

Bosco Verticale | Milan, Italy
2015 BEST TALL BUILDING WORLDWIDE - Council on Tall Buildings and Urban Habitat
2018 RIBA AWARD FOR INTERNATIONAL EXCELLENCE - Royal Institute Of British Architects





LIGHT UP NEW IDEAS!



Indoor

Downlight

Projectors

Ceiling and
pendant lamps

Linear system

Path markers

Small spotlights

Small projectors

Environment care lighting

Environment care lighting

Emergency

Emergency

Outdoor

Ceiling lamps

Wall lamps

Wall path markers

Uplights

Bollards & poles

Linear lights

Accent lighting

Light effects

Underwater

Flex light

Flex light

Electronics

Electronics

Info

Index / Credits





Downlight

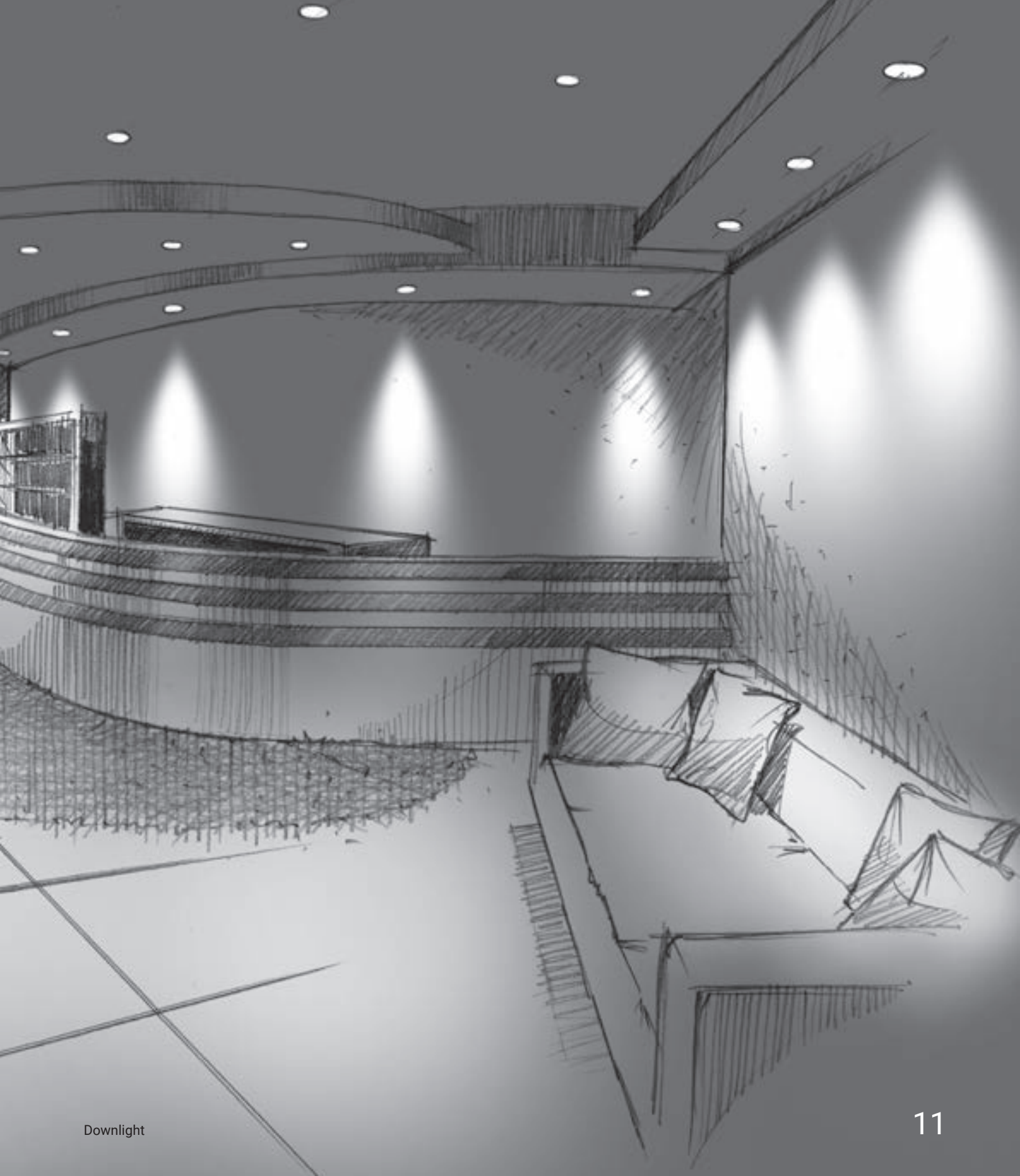

downlight range index

Vos



Quantum

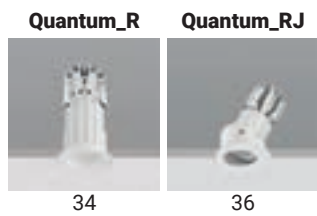

Warp

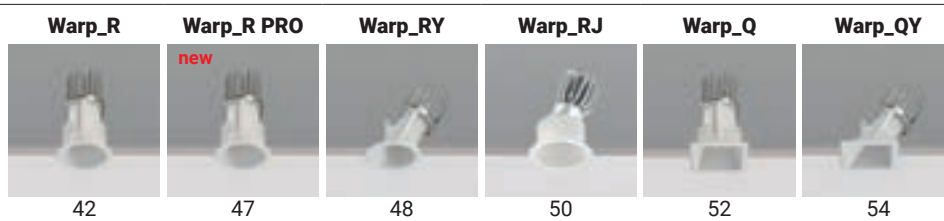

Epitax

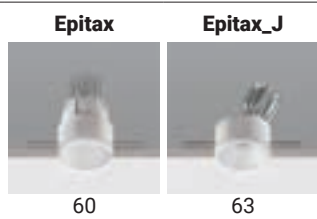

Loro

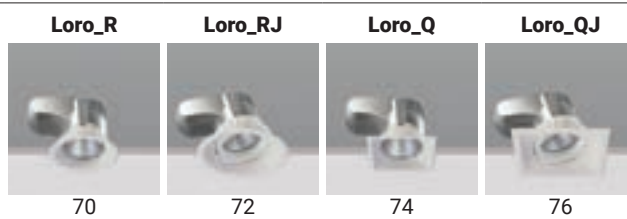



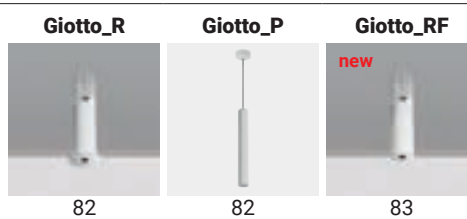



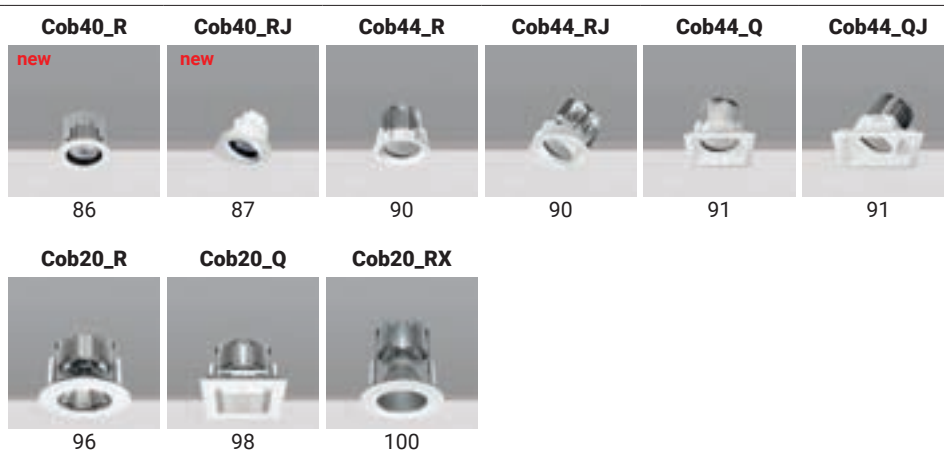



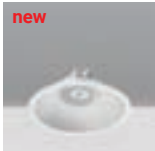







Giotto



Cob

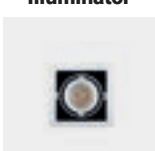
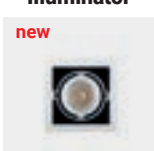
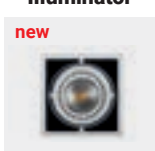

Anton	Anton_R  103	AntonX  105	Anton_RJ  106	
Woofers	Woofers_R <i>new</i>  110	Woofers_RX <i>new</i>  111		
LV HV	LV44_RD  114	LV54_RS  117	LV54_QS  118	HV44  119
Rada	Rada_R  124	Rada_Q  126		
Cell	Gypsum Cell  132	Cell  134	Cell_Ww <i>new</i>  136	
Play_System	Play_Navata  140	Play_Quantum  140	Play_S  140	Play_P  141
Optus_EX	Optus_EX <i>new</i>  146	Optus_EX  147		
Illuminator	Illuminator  152	Illuminator <i>new</i>  153	Illuminator <i>new</i>  154	





FURTHER,
TOGETHER

LA NOSTRA

Contribuire al benessere
l'ingegneria biomedica
alla produzione e alla dis
apparecchiature che all
salute e prolungano qu

Dirigere la nostra cresc
bioingegneria nelle qual
nostra forza e capacità;
che tendono a far cresce
attraverso l'istruzione e
la partecipazione in aree
dare un contributo unico

Mantenere senza riserv
e qualità dei nostri prod
riferimento ed essere ric
istituzionalmente seria e
suoi servizi.



VOS

Matériaux

Corps en aluminium

Collerette en aluminium

Compartiment optique finition noire



vos range



	_R Round	_RJ Round Adjustable	_Q Square	_QJ Square Adjustable	_Ww Wall Washer
1,5 W	Ø 20 mm	-	□ 20 mm	-	-
2 W	Ø 35 mm	-	□ 35 mm	-	-
4 W	Ø 35 mm	Ø 60 mm	□ 35 mm	□ 60 mm	-
6 W	Ø 42 mm	-	□ 42 mm	-	-
8 W	Ø 71 mm	Ø 75 mm	□ 71 mm	□ 75 mm	-
15 W	Ø 105 mm	Ø 100 mm	□ 105 mm	□ 100 mm	-
17 W	-	-	-	-	Ø 135 mm
25 W	Ø 135 mm	-	□ 135 mm	-	-
HC Accessories	2W - 4W - 6W 8W - 15W - 25W	4W - 8W	2W - 4W - 6W 8W - 15W - 25W	4W - 8W	-
Finish	<input type="checkbox"/> White <input type="checkbox"/> Black	<input type="checkbox"/> White <input type="checkbox"/> Black	<input type="checkbox"/> White <input type="checkbox"/> Black	<input type="checkbox"/> White <input type="checkbox"/> Black	<input type="checkbox"/> White <input type="checkbox"/> Black
Balance CRI 92	(1,5W, 2W) 2700K - 3000K 2700K - 3000K - 4000K	2700K - 3000K - 4000K	(1,5W, 2W) 2700K - 3000K 2700K - 3000K - 4000K	2700K - 3000K - 4000K	2700K - 3000K - 4000K
Efficiency CRI 80	2700K - 3000K - 4000K	2700K - 3000K - 4000K	2700K - 3000K - 4000K	2700K - 3000K - 4000K	2700K - 3000K - 4000K
Optics	Spot - Flood - Wide Flood	Spot - Flood - Wide Flood	Spot - Flood - Wide Flood	Spot - Flood - Wide Flood	Asymmetric
Driver	On/Off - 1/10V - DALI	On/Off - 1/10V - DALI	On/Off - 1/10V - DALI	On/Off - 1/10V - DALI	On/Off - 1/10V - DALI
	15 mm / 29 mm / 35 mm 64 mm / 95 mm / 121 mm	56 mm / 70 mm / 95 mm	15 mm / 29 mm / 35 mm 64 mm / 95 mm / 121 mm	56 mm / 70 mm / 95 mm	121 mm

HC Confort visuel

Le filtre en nid d'abeilles intégré dans les versions Honeycomb permet de mieux masquer la source. Les microalvéoles hexagonales qui composent la grille contribuent à masquer le faisceau lumineux secondaire, permettant une réduction presque totale de l'éblouissement.



Honeycomb (optional)

LED

Black side



IP44
IP65

A Sténopé

Le bloc optique utilise le concept du sténopé qui permet de contrôler la réflectance. La source est placée sur un plan en retrait par rapport à l'ouverture du compartiment : les photons du centre du faisceau sortent sans rencontrer d'obstacles ; les photons de la partie externe du faisceau rebondissent quant à eux à l'intérieur du compartiment, peint en noir pour une absorption maximale, et sont progressivement absorbés.

Pin-hole

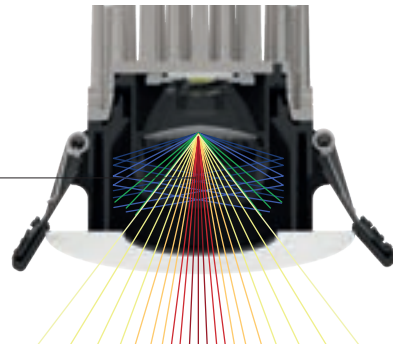

Version orientable

Les familles Vos_RJ et Vos_QJ peuvent pivoter horizontalement à 360° et s'incliner à 35° par rapport à la verticale.

Masquage du bloc optique

La structure du downlight a été conçue pour éviter les dispersions postérieures de lumière et pour masquer l'intérieur du faux plafond.

No spill light

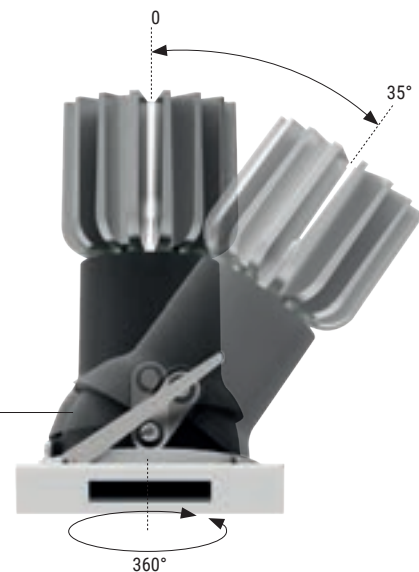

Lèche-mur façonné®

La nouvelle technologie brevetée révolutionne les normes jusqu'alors établies pour l'éclairage lèche-mur. Le diaphragme positionné sur le compartiment optique permet de régler la largeur du faisceau lumineux, pour un éclairage mural polyvalent et performant. Le faisceau parvient toujours à atteindre la zone au niveau du bord du plafond, généralement étroite et difficile à éclairer ; tandis qu'en agissant sur l'ouverture du diaphragme, il est possible de modifier l'angle d'émission et donc de rétrécir ou d'élargir le faisceau, ce qui permet de positionner Vos_Ww à n'importe quelle distance du mur et de maintenir un effet lèche-mur immédiat et précis, parfait pour mettre en valeur les grandes œuvres exposées.

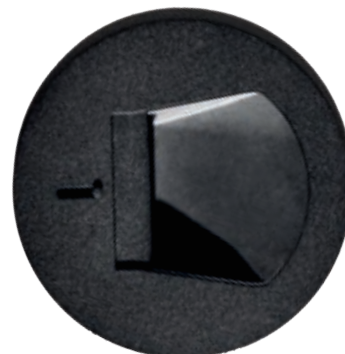

Vos_R | Downlight | powerLED 1,5 W DC 500 mA



15

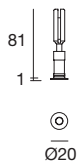

	CRI 92	CRI 80
White	90622	90408
Black	90623	90409

	Cct	lm S - D CRI 92	lm S - D CRI 80	Optic
M	2700	134 - 79	187 - 104	20 Spot (23°)
W	3000	153 - 85	199 - 110	35 Flood (34°)
N	4000	-	213 - 118	

Électronique

99195	89146	99377	99709	99712	+ driver 24V DC 99374 75W 99331 150W
ON/OFF 1 - 2 art. p 138 x l 22 x h 21	ON/OFF 2 - 3 art. p 138 x l 22 x h 21	ON/OFF 3 - 6 art. p 138 x l 22 x h 21	24V DC converter 0/1-10V 1 art. p 138 x l 22 x h 21	24V DC converter DALI 1 art. p 138 x l 22 x h 21	

Vos_R | Downlight | powerLED 4 W DC 350 mA



29

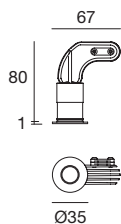

	CRI 92	CRI 92 HC	CRI 80	CRI 80 HC
White	90638	90646	90416	90644
Black	90639	90647	90417	90645

	Cct	lm S - D CRI 92	lm S - D CRI 80	Optic
M	2700	395 - 163	490 - 202	15 Spot (15°)
W	3000	423 - 174	490 - 202	30 Flood (29°)
N	4000	456 - 188	529 - 218	60 W.Flood (50°)

Électronique

89145	99375	99708	99711	+ driver 24V DC 99374 75W 99331 150W
ON/OFF 1 art. p 138 x l 22 x h 21	ON/OFF 2 - 3 art. p 138 x l 22 x h 21	0/1-10V converter 1 art. p 138 x l 22 x h 21	DALI converter 1 art. p 138 x l 22 x h 21	

Boîtier d'encastrement Pag. 21

99847 H. 28 - Ø. 41

Vos_R | Downlight | powerLED 2 W DC 630 mA



29

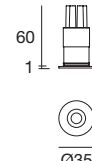

	CRI 92	CRI 92 HC	CRI 80	CRI 80 HC
White	90626	90634	90412	90632
Black	90627	90635	90413	90633

	Cct	lm S - D CRI 92	lm S - D CRI 80	Optic
M	2700	157 - 69	219 - 96	15 Spot (21°)
W	3000	179 - 78	233 - 102	30 Flood (26°)
N	4000	-	249 - 109	60 W.Flood (52°)

Électronique

89147	99376	99105	99710	99713	+ driver 24V DC 99374 75W 99331 150W
ON/OFF 1 - 2 art. p 138 x l 22 x h 21	ON/OFF 3 - 6 art. p 138 x l 22 x h 21	ON/OFF 6 - 12 art. p 103 x l 58 x h 27	24V DC converter 0/1-10V 1 art. p 138 x l 22 x h 21	24V DC converter DALI 1 art. p 138 x l 22 x h 21	

Boîtier d'encastrement Pag. 21

99847 H. 28 - Ø. 41

Vos_R | Downlight | powerLED 6 W DC 500 mA



35

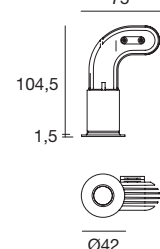

	CRI 92	CRI 92 HC	CRI 80	CRI 80 HC
White	90650	90658	90420	90656
Black	90651	90659	90421	90657

	Cct	lm S - D CRI 92	lm S - D CRI 80	Optic
M	2700	532 - 231	659 - 287	15 Spot (15°)
W	3000	569 - 248	659 - 287	30 Flood (30°)
N	4000	614 - 267	711 - 309	60 W.Flood (50°)

Électronique

99377	89106	99714	99715
ON/OFF 1 art. p 138 x l 22 x h 21	ON/OFF 2-3 art. p 103 x l 58 x h 27	0/1-10V 1 art. p 138 x l 22 x h 21	DALI 1 art. p 138 x l 22 x h 21

Boîtier d'encastrement Pag. 21

99848 H. 28 - Ø. 41

RTG 90650W30 / 90650W60 / 90420W30 / 90420W60

Vos_RJ | Downlight | powerLED 4 W DC 350 mA

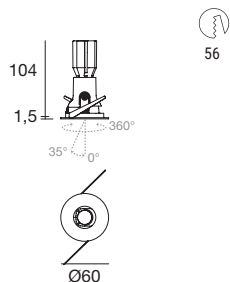

	CRI 92	CRI 92 HC	CRI 80	CRI 80 HC
White	81266	81114	81268	81118
Black	81267	81115	81269	81119

	Cct	lm S - D CRI 92	lm S - D CRI 80	Optic
M	2700	395 - 176	490 - 217	15 Spot (15°)
W	3000	423 - 186	490 - 217	30 Flood (31°)
N	4000	456 - 192	529 - 233	60 Flood (42°)

Électronique

89145	99375	99708	99711	+ driver 24V DC 99374 75W 99331 150W
ON/OFF 1 art. p 138 x 122 x h 21	ON/OFF 2 - 3 art. p 138 x 122 x h 21	0/1-10V converter 1 art. p 138 x 122 x h 21	DALI converter 1 art. p 138 x 122 x h 21	



Boîtier d'encastrement

83063 H. 12 - Ø. 68	89373 H. 83 - Ø. 200
89374 H. 120 - Ø. 200	

Vos_RJ | Downlight | arrayLED 15 W DC 400 mA

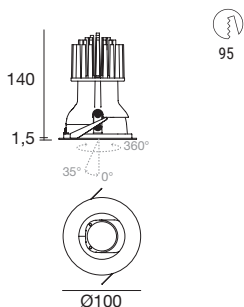

	CRI 92	CRI 80
White	81282	81320
Black	81283	81285

	Cct	lm S - D CRI 92	lm S - D CRI 80	Optic
M	2700	1568 - 679	1932 - 898	15 Spot (22°)
W	3000	1677 - 780	1932 - 898	30 Flood (34°)
N	4000	1804 - 839	2078 - 966	60 Flood (45°)

Électronique

99740	99739	99738
ON/OFF 1 art. p 134 x 137 x h 31	0/1-10V 1 art. p 134 x 137 x h 31	DALI PUSH 1 art. p 134 x 137 x h 31

Boîtier d'encastrement

83065 H. 12 - Ø. 109

RTG 81282W30 / 81282W60

Vos_RJ | Downlight | powerLED 8 W DC 700 mA

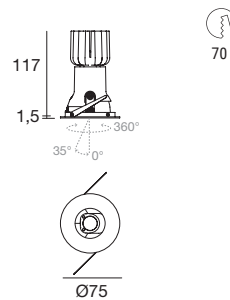

	CRI 92	CRI 92 HC	CRI 80	CRI 80 HC
White	81274	81122	81276	81126
Black	81275	81123	81277	81127

	Cct	lm S - D CRI 92	lm S - D CRI 80	Optic
M	2700	689 - 260	854 - 323	15 Spot (16°)
W	3000	738 - 278	854 - 323	30 Flood (32°)
N	4000	796 - 302	922 - 348	45 W.Flood (49°)

Électronique

99735	99147	99733	99731	99345
ON/OFF 1 art. p 134 x 137 x h 31	ON/OFF 2 - 3 art. p 103 x 158 x h 27	0/1-10V 1 art. p 134 x 137 x h 31	DALI PUSH 1 art. p 134 x 137 x h 31	DALI PSUH 1 - 3 art. p 210 x 148 x h 25

Boîtier d'encastrement

83064 H. 12 - Ø. 83

RTG 81274W30 / 81274W45

description
 83063 Boîtier d'encastrement pour installation affleurante

suitable for: Vos_RJ 4W

description
 83064 Boîtier d'encastrement pour installation affleurante

suitable for: Vos_RJ 8W

description
 83065 Boîtier d'encastrement pour installation affleurante

suitable for: Vos_RJ 15W

description
 89373 Boîtier d'encastrement

suitable for: Vos_RJ 4W

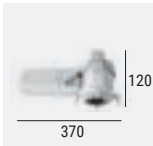
description
 89374 Boîtier d'encastrement

suitable for: Vos_RJ 4W



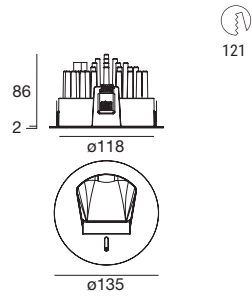

	CRI 92	CRI 80
White	82469	82467
Black	82470	82468

	Cct	lm S - D CRI 92	lm S - D CRI 80	Optic
M	2700	2026 - On req	2447 - On req	07 Asymm. -
W	3000	2174 - On req	2520 - On req	
N	4000	2520 - On req	2717 - On req	

Électronique

99106	99115	99344
ON/OFF	0/1-10V	DALI PUSH
1 art.	1 art.	1 art.
p 103 x l 58 x h 27	p 210 x l 48 x h 28	p 210 x l 48 x h 28

Exemple avec éclairage rasant à distance fixe du mur

Height 2,75 m | Distance 1 m | Sliding Flap Closed



Height 2,75 m | Distance 1 m | Sliding Flap Open

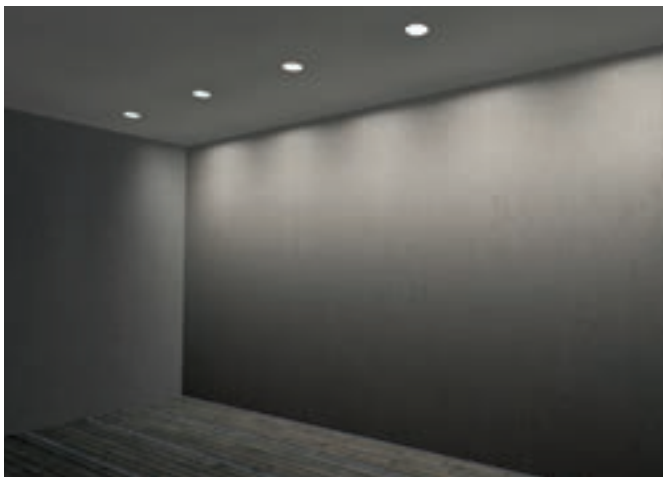

Exemple avec éclairage rasant à distance variable du mur



Height 2,75 m | Distance 0,5 m | Sliding Flap Open

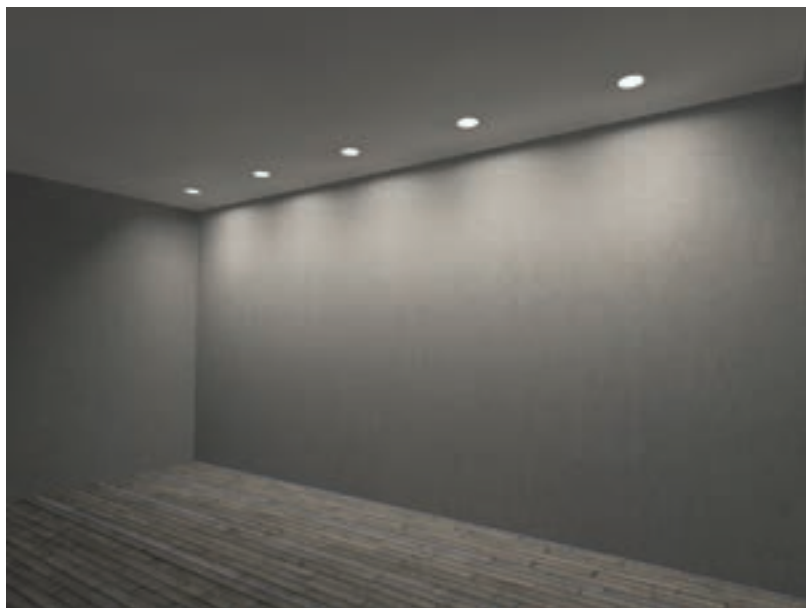
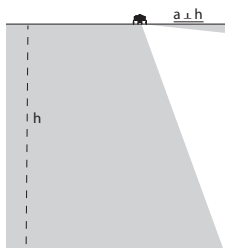

Height 2,75 m | Distance 1 m | Sliding Flap Semi-Open

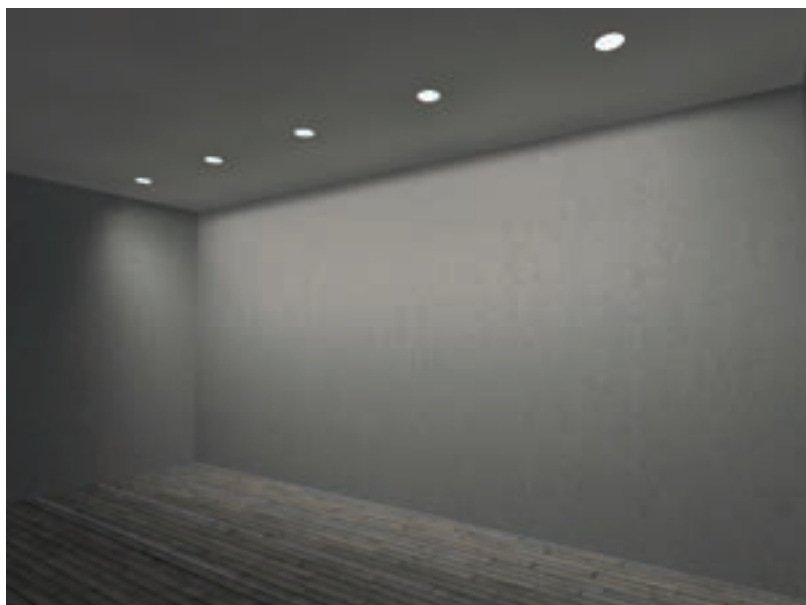
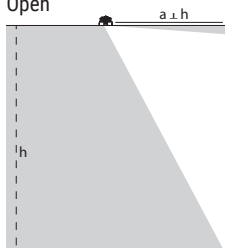

Height 2,75 m | Distance 1,5 m | Sliding Flap Closed

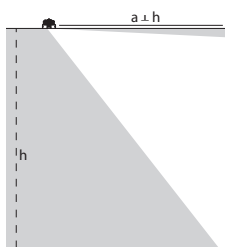

Vos_Q | Downlight | powerLED 1,5 W DC 500 mA



15



□20

	CRI 92	CRI 80
White	90620	90406
Black	90621	90407

	Cct	lm S - D CRI 92	lm S - D CRI 80	Optic
M	2700	134 - 69	187 - 91	20 Spot (21°)
W	3000	153 - 74	199 - 97	35 Flood (35°)
N	4000	-	213 - 103	

Électronique

99195	89146	99377	99709	99712	+ driver 24V DC 99374 75W 99331 150W
ON/OFF 1 - 2 art. p 138 x 122 x h 21	ON/OFF 2 - 3 art. p 138 x 122 x h 21	ON/OFF 3 - 6 art. p 138 x 122 x h 21	24V DC converter 0/1-10V 1 art. p 138 x 122 x h 21	24V DC converter DALI 1 art. p 138 x 122 x h 21	

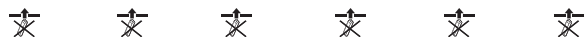

Vos_Q | Downlight | powerLED 2 W DC 630 mA



29



□35

	CRI 92	CRI 92 HC	CRI 80	CRI 80 HC
White	90624	90630	90410	90628
Black	90625	90631	90411	90629

	Cct	lm S - D CRI 92	lm S - D CRI 80	Optic
M	2700	157 - 50	219 - 70	15 Spot (22°)
W	3000	179 - 57	233 - 75	30 Flood (25°)
N	4000	-	249 - 80	60 W.Flood (46°)

Électronique

89147	99376	99105	99710	99713	+ driver 24V DC 99374 75W 99331 150W
ON/OFF 1 - 2 art. p 138 x 122 x h 21	ON/OFF 3 - 6 art. p 138 x 122 x h 21	ON/OFF 6 - 12 art. p 103 x 158 x h 27	24V DC converter 0/1-10V 1 art. p 138 x 122 x h 21	24V DC converter DALI 1 art. p 138 x 122 x h 21	



Vos_Q | Downlight | powerLED 4 W DC 350 mA



29

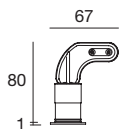

□35

	CRI 92	CRI 92 HC	CRI 80	CRI 80 HC
White	90636	90642	90414	90640
Black	90637	90643	90415	90641

	Cct	lm S - D CRI 92	lm S - D CRI 80	Optic
M	2700	395 - 130	490 - 161	15 Spot (15°)
W	3000	423 - 139	490 - 161	30 Flood (27°)
N	4000	456 - 150	529 - 173	60 W.Flood (46°)

Électronique

89145	99375	99708	99711	+ driver 24V DC 99374 75W 99331 150W
ON/OFF 1 art. p 138 x 122 x h 21	ON/OFF 2 - 3 art. p 138 x 122 x h 21	0/1-10V converter 1 art. p 138 x 122 x h 21	DALI converter 1 art. p 138 x 122 x h 21	



Vos_Q | Downlight | powerLED 6 W DC 500 mA



35

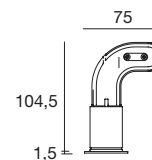

□42

	CRI 92	CRI 92 HC	CRI 80	CRI 80 HC
White	90648	90654	90418	90652
Black	90649	90655	90419	90653

	Cct	lm S - D CRI 92	lm S - D CRI 80	Optic
M	2700	532 - 225	659 - 278	15 Spot (14°)
W	3000	569 - 240	659 - 278	30 Flood (28°)
N	4000	614 - 259	711 - 300	60 W.Flood (46°)

Électronique

99377	99106	99714	99715
ON/OFF 1 art. p 138 x 122 x h 21	ON/OFF 2-3 art. p 103 x 158 x h 27	0/1-10V 1 art. p 138 x 122 x h 21	DALI 1 art. p 138 x 122 x h 21

Vos_Q | Downlight | powerLED 8 W DC 700 mA

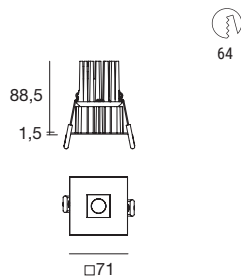

	CRI 92	CRI 92 HC	CRI 80	CRI 80 HC
White	90660	90666	90428	90664
Black	90661	90667	90429	90665

	Cct	lm S - D CRI 92	lm S - D CRI 80	Optic
M	2700	689 - 369	854 - 671	15 Spot (15°)
W	3000	738 - 396	854 - 723	30 Flood (30°)
N	4000	796 - 427	922 - 776	45 W.Flood (52°)

Électronique

99735	99147	99733	99731	99345
ON/OFF 1 art. p 134 x 137 x h 31	ON/OFF 2 - 3 art. p 103 x 158 x h 27	0/1-10V 1 art. p 134 x 137 x h 31	DALI PUSH 1 art. p 134 x 137 x h 31	DALI PSUH 1 - 3 art. p 210 x 148 x h 25

Boîtier d'encastrement

89373 H. 83 - Ø. 200 **89374** H. 120 - Ø. 200

* avec boîtier d'encastrement pour brique creuse, réduction de la puissance à 6 W DC 500 mA

Vos_Q | Downlight | arrayLED 25 W DC 700 mA

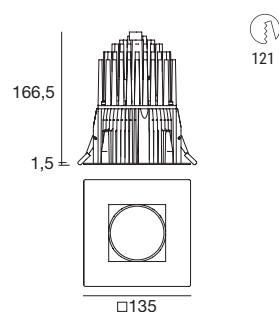
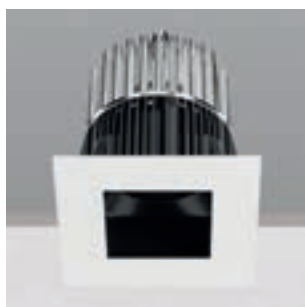

	CRI 92	CRI 92 HC	CRI 80	CRI 80 HC
White	80726	90686	80728	90684
Black	80727	90687	80729	90685

	Cct	lm S - D CRI 92	lm S - D CRI 80	Optic
M	2700	2598 - 1340	3210 - 1655	15 Spot (21°)
W	3000	2794 - 1441	3431 - 1796	30 Flood (34°)
N	4000	2990 - 1542	3431 - 1796	60 Flood (42°)

Électronique

99112	83066	99330
ON/OFF 1 art. p 103 x 158 x h 27	0/1-10V DALI PUSH 1 art. p 124 x 167 x h 22	DALI PUSH 1 art. p 210 x 148 x h 28

Vos_Q | Downlight | arrayLED 15 W DC 400 mA

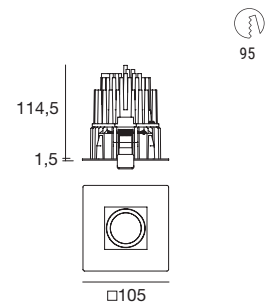

	CRI 92	CRI 92 HC	CRI 80	CRI 80 HC
White	90672	90678	90438	90676
Black	90673	90679	90439	90677

	Cct	lm S - D CRI 92	lm S - D CRI 80	Optic
M	2700	1568 - 868	1932 - 1070	15 Spot (20°)
W	3000	1677 - 929	1932 - 1070	30 Flood (33°)
N	4000	1804 - 999	2078 - 1151	60 W.Flood (49°)

Électronique

99740	99739	99738
ON/OFF 1 art. p 134 x 137 x h 31	0/1-10V 1 art. p 134 x 137 x h 31	DALI PUSH 1 art. p 134 x 137 x h 31



description

89373* Boîtier d'encastrement

suitable for: Vos_Q 8W

Driver: **99377** (On/Off 1art.) - **99106** (On/Off 2-3art.)
99714 (0/1-10V 1art.) - **99715** (DALI 1art.)



description

89374* Boîtier d'encastrement

suitable for: Vos_Q 8W

Driver: **99377** (On/Off 1art.) - **99106** (On/Off 2-3art.)
99714 (0/1-10V 1art.) - **99715** (DALI 1art.)

* avec boîtier d'encastrement pour brique creuse, réduction de la puissance à 6 W DC 500 mA

Vos_QJ | Downlight | powerLED 4 W DC 350 mA

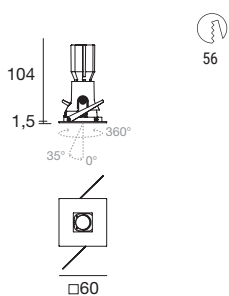

	CRI 92	CRI 92 HC	CRI 80	CRI 80 HC
White	81270	80478	81272	80476
Black	81271	80479	81273	80477

	Cct	lm S - D CRI 92	lm S - D CRI 80	Optic
M	2700	395 - 143	490 - 178	15 Spot (15°)
W	3000	423 - 154	490 - 178	30 Flood (26°)
N	4000	456 - 166	529 - 192	60 Flood (38°)

Électronique

89145	99375	99708	99711	+ driver 24V DC 99374 75W 99331 150W
ON/OFF 1 art. p 138 x 122 x h 21	ON/OFF 2 - 3 art. p 138 x 122 x h 21	0/1-10V converter 1 art. p 138 x 122 x h 21	DALI converter 1 art. p 138 x 122 x h 21	



Boîtier d'encastrement

89373 H. 83 - Ø. 200	89374 H. 120 - Ø. 200
-----------------------------	------------------------------

Vos_QJ | Downlight | arrayLED 15 W DC 400 mA

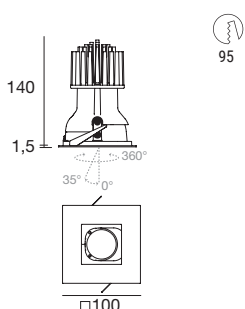

	CRI 92	CRI 80
White	81286	81288
Black	81287	81289

	Cct	lm S - D CRI 92	lm S - D CRI 80	Optic
M	2700	1568 - 586	1932 - 776	15 Spot (22°)
W	3000	1677 - 673	1932 - 776	30 Flood (33°)
N	4000	1804 - 725	2078 - 835	60 Flood (42°)

Électronique

99740	99739	99738
ON/OFF 1 art. p 134 x 137 x h 31	0/1-10V 1 art. p 134 x 137 x h 31	DALI PUSH 1 art. p 134 x 137 x h 31

Vos_QJ | Downlight | powerLED 8 W DC 700 mA

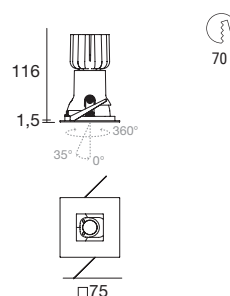

	CRI 92	CRI 92 HC	CRI 80	CRI 80 HC
White	81278	80490	81280	80488
Black	81279	80491	81281	80489

	Cct	lm S - D CRI 92	lm S - D CRI 80	Optic
M	2700	689 - 298	854 - 370	15 Spot (15°)
W	3000	738 - 320	854 - 370	30 Flood (32°)
N	4000	796 - 346	922 - 400	45 W.Flood (45°)

Électronique

99735	99147	99733	99731	99345
ON/OFF 1 art. p 134 x 137 x h 31	ON/OFF 2 - 3 art. p 103 x 158 x h 27	0/1-10V 1 art. p 134 x 137 x h 31	DALI PUSH 1 art. p 134 x 137 x h 31	DALI PSUH 1 - 3 art. p 210 x 148 x h 25



description

89373 Boîtier d'encastrement
suitable for: Vos_QJ 4W

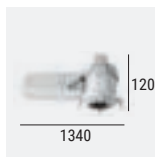

description

89374 Boîtier d'encastrement
suitable for: Vos_QJ 4W





quantum

Matériaux
Corps en aluminium



quantum range



	_R Round	_RJ Round Adjustable
1,5 W	Ø 18 mm	-
2 W	Ø 24 mm	Ø 50 mm
4 W	Ø 35 mm	Ø 50 mm
6 W	Ø 42 mm	Ø 55 mm
10 W	Ø 60 mm	Ø 70 mm
15 W	Ø 83 mm	Ø 80 mm
25 W	Ø 135 mm	-
HC Accessories	4W - 6W - 10W 15W - 25W	2W - 4W - 6W 10W - 15W
Finish	White Black Gold	White Black
Balance	(1,5W/2W) 2700K - 3000K	(2W) 2700K - 3000K
CRI 92	2700K - 3000K - 4000K	2700K - 3000K - 4000K
Efficiency	2700K - 3000K - 4000K	2700K - 3000K - 4000K
CRI 80	2700K - 3000K - 4000K	2700K - 3000K - 4000K
Optics	Spot - Flood - Wide Flood	Spot - Flood - Wide Flood
Driver	On/Off - 1/10V - DALI	On/Off - 1/10V - DALI
	15 mm - 20 mm - 29 mm - 35 mm 52 mm - 75 mm - 125 mm	44 mm - 49 mm 64 mm - 73 mm

F.O.L.™

L'unité optique est composée d'une lentille en polycarbonate combiné avec des filtres FOL™ (Filtering Optical Layers) : un système breveté de un filtre en polyéthylène téréphtalate avec différents niveaux d'opacité qui garantit un faisceau lumineux propre et une excellente efficacité optique.



reddot award 2015
winner

HC Confort visuel

Le filtre en nid d'abeilles intégré dans les versions Honeycomb permet de mieux masquer la source. Les microalvéoles hexagonales qui composent la grille contribuent à masquer le faisceau lumineux secondaire, permettant une réduction presque totale de l'éblouissement.

Organic design



LED



Honeycomb
(optional)



IP44
IP65

Adjustable

Les articles de la série Quantum_RJ peuvent s'incliner à 35° par rapport à la verticale.



Quantum_R | Downlight | powerLED 1,5 W DC 500 mA

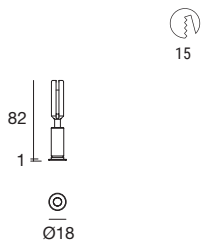

	CRI 92	CRI 80
White	80009	90554
Black	80010	90555
Gold	82865	82866

Cct	lm S - D CRI 92	lm S - D CRI 80	Optic
M 2700	134 - 50	187 - 69	20 Flood (24°)
W 3000	153 - 58	199 - 74	35 Flood (35°)
N 4000	-	213 - 80	

Électronique

99195	89146	99377	99709	99712	+ driver 24V DC 99374 75W 99331 150W
ON/OFF 1 - 2 art. p 138 x l 22 x h 21	ON/OFF 2 - 3 art. p 138 x l 22 x h 21	ON/OFF 3 - 6 art. p 138 x l 22 x h 21	24V DC converter 0/1-10V 1 art. p 138 x l 22 x h 21	24V DC converter DALI 1 art. p 138 x l 22 x h 21	

Quantum_R | Downlight | powerLED 4 W DC 350 mA

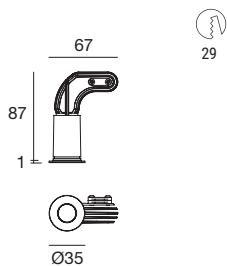

	CRI 92	CRI 92 HC	CRI 80	CRI 80 HC
White	80017	80021	90558	80019
Black	80018	80022	90559	80020
Gold	82869	82870	82871	82872

Cct	lm S - D CRI 92	lm S - D CRI 80	Optic
M 2700	395 - 210	490 - 260	15 Spot (15°)
W 3000	423 - 224	490 - 260	30 Flood (29°)
N 4000	456 - 242	529 - 281	45 W.Flood(50°)

Électronique

89145	99375	99708	99711	+ driver 24V DC 99374 75W 99331 150W
ON/OFF 1 art. p 138 x l 22 x h 21	ON/OFF 2 - 3 art. p 138 x l 22 x h 21	0/1-10V converter 1 art. p 138 x l 22 x h 21	DALI converter 1 art. p 138 x l 22 x h 21	

Quantum_R | Downlight | powerLED 2 W DC 630 mA

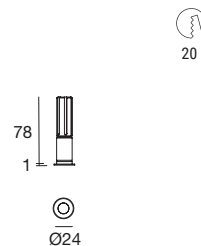

	CRI 92	CRI 80
White	80011	90556
Black	80012	90557
Gold	82867	82868

Cct	lm S - D CRI 92	lm S - D CRI 80	Optic
M 2700	157 - 65	219 - 91	15 Spot (19°)
W 3000	179 - 74	233 - 96	30 Flood (25°)
N 4000	-	249 - 103	45 Flood (45°)

Électronique

89147	99376	99105	99710	99713	+ driver 24V DC 99374 75W 99331 150W
ON/OFF 1 - 2 art. p 138 x l 22 x h 21	ON/OFF 3 - 6 art. p 138 x l 22 x h 21	ON/OFF 6 - 12 art. p 103 x l 58 x h 27	24V DC converter 0/1-10V 1 art. p 138 x l 22 x h 21	24V DC converter DALI 1 art. p 138 x l 22 x h 21	

RTG 90556W15 / 90556W30 / 90556W45

Quantum_R | Downlight | powerLED 6 W DC 500 mA

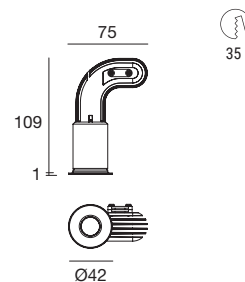

	CRI 92	CRI 92 HC	CRI 80	CRI 80 HC
White	80023	80027	90560	80025
Black	80024	80028	90561	80026
Gold	82873	82874	82875	82876

Cct	lm S - D CRI 92	lm S - D CRI 80	Optic
M 2700	532 - 300	659 - 374	15 Spot (15°)
W 3000	569 - 321	659 - 374	30 Flood (30°)
N 4000	614 - 346	711 - 401	45 W.Flood(49°)

Électronique

99377	99106	99714	99715
ON/OFF 1 art. p 138 x l 22 x h 21	ON/OFF 2-3 art. p 103 x l 58 x h 27	0/1-10V 1 art. p 138 x l 22 x h 21	DALI 1 art. p 138 x l 22 x h 21

RTG 90560W15 / 90560W30 / 90560W45

Quantum_R | Downlight | powerLED 10 W DC 800 mA

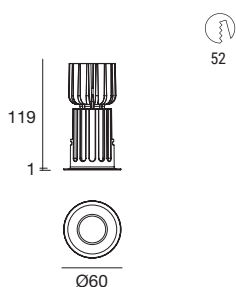

	CRI 92	CRI 92 HC	CRI 80	CRI 80 HC
White	80029	80033	90562	80031
Black	80030	80034	90563	80032
Gold	82877	82878	82879	82880

	Cct	lm S - D CRI 92	lm S - D CRI 80	Optic
M	2700	960 - 657	1108 - 760	15 Spot (18°)
W	3000	1034 - 709	1194 - 819	30 Flood (25°)
N	4000	1108 - 762	1280 - 880	45 W.Flood(47°)

Électronique

99735	99135	99733	99731	99345
ON/OFF 1 art. p 134 x l 137 x h 31	ON/OFF 2 - 3 art. p 103 x l 58 x h 27	0/1-10V 1 art. p 134 x l 37 x h 31	DALI PUSH 1 art. p 134 x l 37 x h 31	DALI PUSH 1 - 3 art. p 210 x l 48 x h 25



RTG 90562W15 / 90562W30 / 90562W45

Quantum_R | Downlight | arrayLED 25 W DC 700 mA

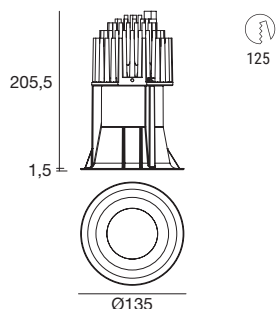

	CRI 92	CRI 92 HC	CRI 80	CRI 80 HC
White	80041	80045	90609	80043
Black	80042	80046	90610	80044
Gold	82885	82886	82887	82888

	Cct	lm S - D CRI 92	lm S - D CRI 80	Optic
M	2700	2598 - 1563	3210 - 1928	15 Spot (21°)
W	3000	2794 - 1679	3431 - 2061	30 Flood (31°)
N	4000	2990 - 1792	3431 - 2061	45 Flood (34°)

Électronique

99112	83066	99330
ON/OFF 1 art. p 103 x l 58 x h 27	0/1-10V DALI PUSH 1 art. p 124 x l 67 x h 22	DALI PUSH 1 art. p 210 x l 48 x h 28

Quantum_R | Downlight | arrayLED 15 W DC 400 mA

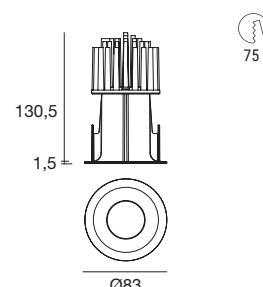

	CRI 92	CRI 92 HC	CRI 80	CRI 80 HC
White	80035	80039	90564	80037
Black	80036	80040	90565	80038
Gold	82881	82882	82883	82884

	Cct	lm S - D CRI 92	lm S - D CRI 80	Optic
M	2700	1568 - 880	1932 - 1085	15 Spot (20°)
W	3000	1677 - 942	1932 - 1085	30 Flood (30°)
N	4000	1804 - 1014	2078 - 1167	45 Flood (40°)

Électronique

99740	99739	99738
ON/OFF 1 art. p 134 x l 37 x h 31	0/1-10V 1 art. p 134 x l 37 x h 31	DALI PUSH 1 art. p 134 x l 37 x h 31

Quantum_RJ | Downlight | powerLED 2 W DC 630 mA

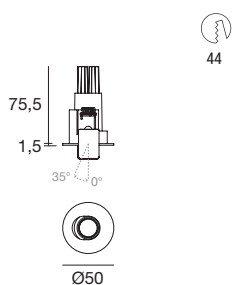

	CRI 92	CRI 92 HC	CRI 80	CRI 80 HC
White	80047	80051	90566	80049
Black	80048	80052	90567	80050

	Cct	lm S - D CRI 92	lm S - D CRI 80	Optic
M	2700	157 - 66	219 - 92	15 Spot -
W	3000	179 - 75	233 - 98	30 Flood -
N	4000	-	249 - 104	45 Flood -

Électronique

89147	99376	99105	99710	99713	+ driver 24V DC 99374 75W 99331 150W
ON/OFF 1 - 2 art. p 138 x 122 x h 21	ON/OFF 3 - 6 art. p 138 x 122 x h 21	ON/OFF 6 - 12 art. p 103 x 158 x h 27	24V DC converter 0/1-10V 1 art. p 138 x 122 x h 21	24V DC converter DALI 1 art. p 138 x 122 x h 21	



Quantum_RJ | Downlight | powerLED 4 W DC 350 mA

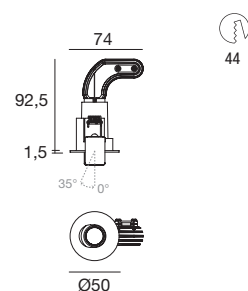

	CRI 92	CRI 92 HC	CRI 80	CRI 80 HC
White	80053	80057	90568	80055
Black	80054	80058	90569	80056

	Cct	lm S - D CRI 92	lm S - D CRI 80	Optic
M	2700	395 - 183	490 - 227	15 Spot -
W	3000	423 - 196	490 - 227	30 Flood -
N	4000	456 - 211	529 - 245	45 Flood -

Électronique

89145	99375	99708	99711	+ driver 24V DC 99374 75W 99331 150W
ON/OFF 1 art. p 138 x 122 x h 21	ON/OFF 2 - 3 art. p 138 x 122 x h 21	0/1-10V converter 1 art. p 138 x 122 x h 21	DALI converter 1 art. p 138 x 122 x h 21	



Quantum_RJ | Downlight | powerLED 6 W DC 500 mA

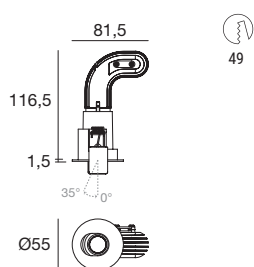

	CRI 92	CRI 92 HC	CRI 80	CRI 80 HC
White	80059	80063	90570	80061
Black	80060	80064	90571	80062

	Cct	lm S - D CRI 92	lm S - D CRI 80	Optic
M	2700	532 - 300	659 - 374	15 Spot -
W	3000	569 - 269	659 - 374	30 Flood -
N	4000	614 - 346	711 - 401	45 Flood -

Électronique

99377	99106	99714	99715
ON/OFF 1 art. p 138 x 122 x h 21	ON/OFF 2-3 art. p 103 x 158 x h 27	0/1-10V 1 art. p 138 x 122 x h 21	DALI 1 art. p 138 x 122 x h 21



Quantum_RJ | Downlight | powerLED 10 W DC 800 mA

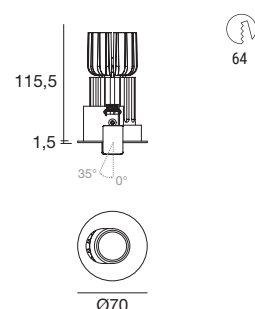

	CRI 92	CRI 92 HC	CRI 80	CRI 80 HC
White	80065	80069	90572	80067
Black	80066	80070	90573	80068

	Cct	lm S - D CRI 92	lm S - D CRI 80	Optic
M	2700	960 - 667	1108 - 770	15 Spot -
W	3000	1034 - 718	1194 - 830	30 Flood -
N	4000	1108 - 770	1280 - 889	45 Flood -

Électronique

99735	99135	99733	99731	99345
ON/OFF 1 art. p 134 x 137 x h 31	ON/OFF 2 - 3 art. p 103 x 158 x h 27	0/1-10V 1 art. p 134 x 137 x h 31	DALI PUSH 1 art. p 134 x 137 x h 31	DALI PUSH 1 - 3 art. p 210 x 148 x h 25

Quantum_RJ | Downlight | arrayLED 15 W DC 400 mA

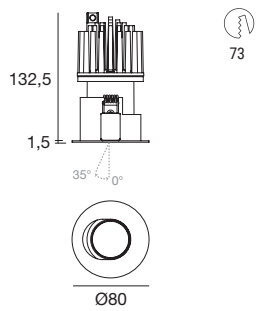

	CRI 92	CRI 92 HC	CRI 80	CRI 80 HC
White	80071	80075	90574	80073
Black	80072	80076	90575	80074

	Cct	lm S - D CRI 92		lm S - D CRI 80		Optic
M	2700	1568	830	1932	1023	15 Spot -
W	3000	1677	888	1932	1023	30 Flood -
N	4000	1804	955	2078	1100	45 Flood -

Électronique

99740	99739	99738
ON/OFF 1 art. p 134 x 137 x h 31	0/1-10V 1 art. p 134 x 137 x h 31	DALI PUSH 1 art. p 134 x 137 x h 31

Ferro Wine | Castelfranco V.to, Italy





warp

Matériaux
Corps en aluminium



warp range



	_R Round	_R PRO Round	_RY Round Asymmetric	_RJ Round Adjustable	_Q Square	_QY Square Asymmetric
2 W	Ø 35 mm	-	Ø 50 mm	-	□ 35 mm	□ 50 mm
4 W	Ø 35 mm	-	Ø 50 mm	-	□ 35 mm	□ 50 mm
6 W	Ø 42 mm	-	-	-	□ 42 mm	-
8 W	-	-	-	Ø 80 mm	-	-
10 W	Ø 71 mm	-	Ø 71 mm	-	□ 71 mm	□ 71 mm
11 W	-	Ø 71 mm	-	-	-	-
15 W	Ø 100 mm	Ø 100 mm	Ø 100 mm	Ø 120 mm	□ 100 mm	□ 100 mm
25 W	Ø 135 mm	Ø 135 mm	Ø 134 mm	-	□ 135 mm	□ 134 mm
45 W	Ø 135 mm	-	-	-	-	-
HC Accessories	2W - 4W - 6W 10W - 25W - 45W	-	2W - 4W - 6W 10W - 25W	-	2W - 4W - 6W 10W - 25W	2W - 4W - 6W 10W - 25W
Finish	<input type="checkbox"/> White <input checked="" type="checkbox"/> Black	<input type="checkbox"/> White <input checked="" type="checkbox"/> Black	<input type="checkbox"/> White <input checked="" type="checkbox"/> Black	<input type="checkbox"/> White <input checked="" type="checkbox"/> Black	<input type="checkbox"/> White <input checked="" type="checkbox"/> Black	<input type="checkbox"/> White <input checked="" type="checkbox"/> Black
Balance CRI 92	(2W) 2700K - 3000K 2700K - 3000K - 4000K	2700K - 3000K 4000K	2700K - 3000K 4000K	2700K - 3000K 4000K	2700K - 3000K 4000K	2700K - 3000K 4000K
Efficiency CRI 80	2700K - 3000K 4000K	2700K - 3000K 4000K	2700K - 3000K 4000K	2700K - 3000K 4000K	2700K - 3000K 4000K	2700K - 3000K 4000K
WarmTune 1800K/3000K	15W - 25W	-	-	-	-	-
DynamicWhite 2700K - 5700K	Ø 71 mm - Ø 100 mm Ø 135 mm	-	-	Ø 80 mm Ø 120 mm	□ 71 mm - □ 100 mm □ 135 mm	-
Optics	Spot - Flood Wide Flood	Spot - Flood	Spot - Flood Wide Flood	Spot - Flood Wide Flood	Spot - Flood Wide Flood	Spot - Flood Wide Flood
Driver	On/Off - 1/10V - DALI - Fase-Cut	On/Off - 1/10V DALI	On/Off - 1/10V - DALI	On/Off - 1/10V - DALI	On/Off - 1/10V - DALI - Fase-Cut	On/Off - 1/10V - DALI
	29 mm - 35 mm - 64 mm 92 mm - 127 mm	64 mm 92 mm - 127 mm	46 mm - 64 mm 92 mm - 128 mm	70 mm - 105 mm	29 mm □ 35 mm - □ 64 mm □ 91 mm - □ 126 mm	□ 46 mm - □ 64 mm □ 92 mm - □ 128 mm

HC Confort visuel

Le filtre en nid d'abeilles intégré dans les versions Honeycomb permet de mieux masquer la source. Les microalvéoles hexagonales qui composent la grille contribuent à masquer le faisceau lumineux secondaire, permettant une réduction presque totale de l'éblouissement.

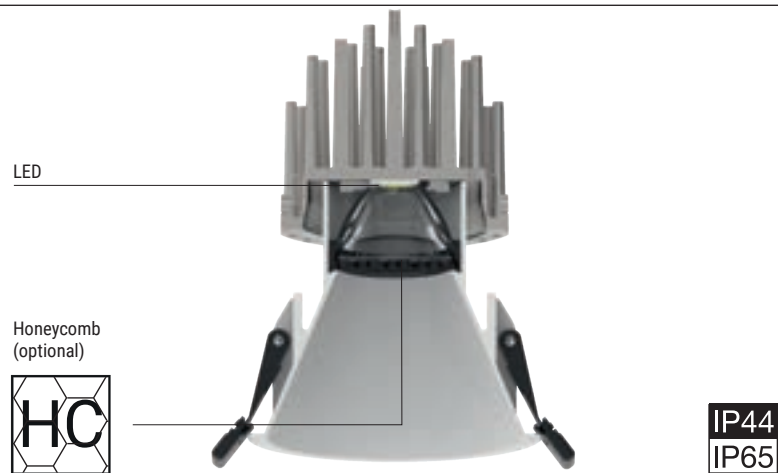

Versión asimétrica

Les articles de la famille Warp_RY et Warp_QY sont inclinés de 25° et émettent un faisceau asymétrique, idéal pour distribuer uniformément la lumière sur les surfaces latérales. La configuration inclinée du corps de la lampe permet de dissimuler la source lumineuse, éliminant ainsi l'éblouissement direct.

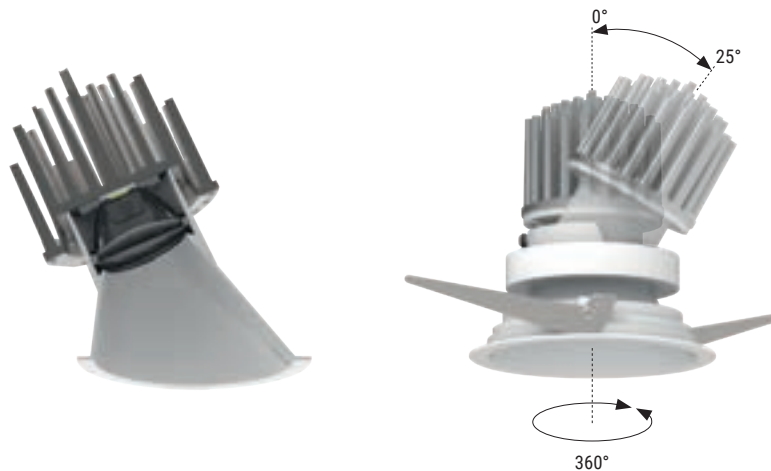

Versión orientable

Les articles de la série Warp_RJ peuvent pivoter horizontalement à 360° et s'incliner à 25° par rapport à la verticale.

Verre optique

Grâce aux verres optiques spéciaux, spécialement conçus pour loger dans la cage optique de Warp_R PRO, la distribution du faisceau lumineux est réellement meilleure en assurant uniformité et netteté.

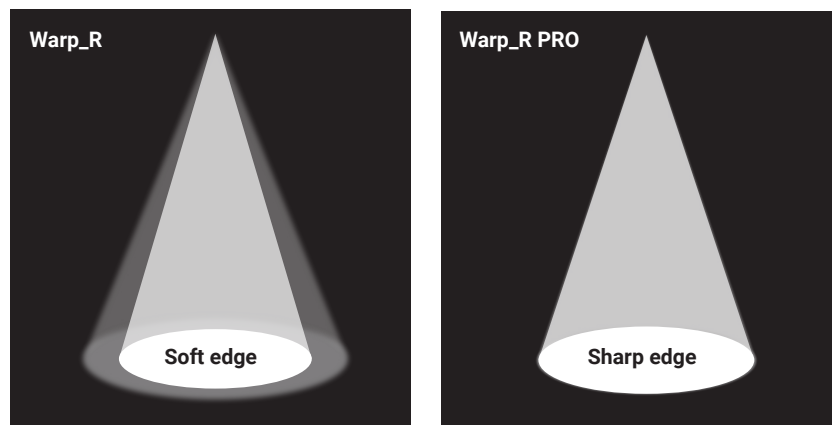

Éclairage intelligent

Les modules Dynamic White, associés aux nouveaux systèmes de gestion spécifiquement développés, permettent de mélanger les nuances de blanc allant de Warm White à Cold White. Il est donc possible, avec un seul produit, de reproduire toutes les températures de couleur de 2700 K à 6500 K, en maintenant le même flux lumineux. Des études récentes sur les cycles circadiens ont démontré comment les variations de la température de la lumière naturelle, du lever au coucher du soleil, affectaient le bien-être des personnes.

DW

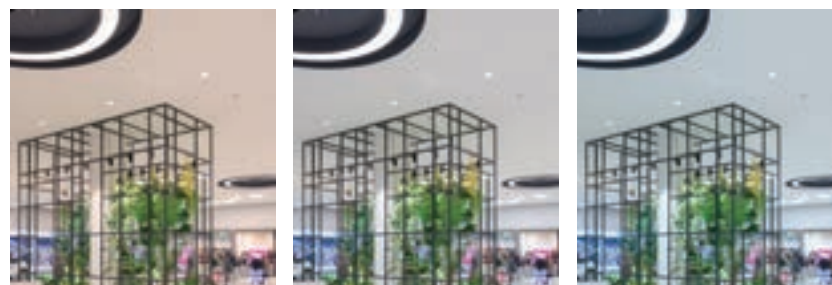

2700K

6500K

Warp_R | Downlight | powerLED 2 W DC 630 mA

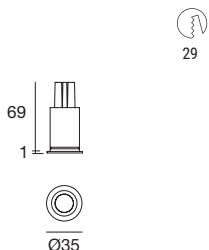

	CRI 92	CRI 92 HC	CRI 80	CRI 80 HC
White	90542	90722	90544	90720
Black	90543	90723	90545	90721

	Cct	lm S - D CRI 92	lm S - D CRI 80	Optic
M	2700	157 - 81	219 - 113	15 Spot (21°)
W	3000	179 - 93	233 - 121	30 Flood (25°)
N	4000	-	249 - 129	60 W.Flood (46°)

Électronique

89147	99376	99105	99710	99713	+ driver 24V DC 99374 75W 99331 150W
ON/OFF 1 - 2 art. p 138 x 122 x h 21	ON/OFF 3 - 6 art. p 138 x 122 x h 21	ON/OFF 6 - 12 art. p 103 x 158 x h 27	24V DC converter 0/1-10V 1 art. p 138 x 122 x h 21	24V DC converter DALI 1 art. p 138 x 122 x h 21	



RTG 90544W15 / 90544W30 / 90544M15 / 90544M30

Warp_R | Downlight | powerLED 6 W DC 500 mA

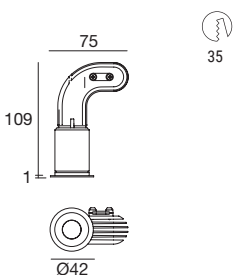
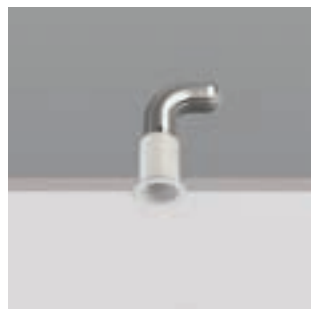

	CRI 92	CRI 92 HC	CRI 80	CRI 80 HC
White	90748	90752	90548	90750
Black	90749	90753	90549	90751

	Cct	lm S - D CRI 92	lm S - D CRI 80	Optic
M	2700	532 - 331	659 - 410	15 Spot (17°)
W	3000	569 - 354	659 - 410	30 Flood (27°)
N	4000	614 - 382	711 - 442	60 Flood (39°)

Électronique

99377	99106	99714	99715
ON/OFF 1 art. p 138 x 122 x h 21	ON/OFF 2-3 art. p 103 x 158 x h 27	0/1-10V 1 art. p 138 x 122 x h 21	DALI 1 art. p 138 x 122 x h 21



RTG 90548W30 / 90548W60 / 90548M30 / 90548M60

Warp_R | Downlight | powerLED 4 W DC 350 mA

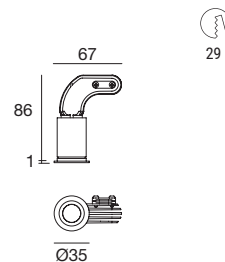

	CRI 92	CRI 92 HC	CRI 80	CRI 80 HC
White	90740	90744	90546	90742
Black	90741	90745	90547	90743

	Cct	lm S - D CRI 92	lm S - D CRI 80	Optic
M	2700	395 - 219	490 - 273	15 Spot (16°)
W	3000	423 - 236	490 - 273	30 Flood (30°)
N	4000	456 - 254	529 - 295	60 W.Flood (49°)

Électronique

89145	99375	99708	99711	+ driver 24V DC 99374 75W 99331 150W
ON/OFF 1 art. p 138 x 122 x h 21	ON/OFF 2 - 3 art. p 138 x 122 x h 21	0/1-10V converter 1 art. p 138 x 122 x h 21	DALI converter 1 art. p 138 x 122 x h 21	



Warp_R | Downlight | powerLED 10 W DC 800 mA

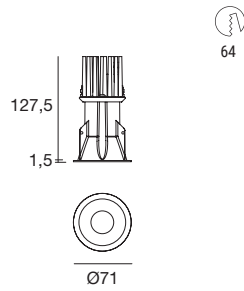

	CRI 92	CRI 92 HC	CRI 80	CRI 80 HC
White	90762	90766	90550	90764
Black	90763	90767	90551	90765

	Cct	lm S - D CRI 92	lm S - D CRI 80	Optic
M	2700	960 - 693	1108 - 800	15 Spot (17°)
W	3000	1034 - 746	1194 - 861	30 Flood (27°)
N	4000	1108 - 800	1280 - 924	60 Flood (39°)

Électronique

99735	99135	99733	99731	99345
ON/OFF 1 art. p 134 x 137 x h 31	ON/OFF 2 - 3 art. p 103 x 158 x h 27	0/1-10V 1 art. p 134 x 137 x h 31	DALI PUSH 1 art. p 134 x 137 x h 31	DALI PUSH 1 - 3 art. p 210 x 148 x h 25



RTG 90550M15 / 90550M30 / 90550M60 / 90550W15 / 90550W30 / 90550W60

DW **NEW** 8 W DC 700 mA

	Dynamic White	HC Dynamic White
White	84083	84085
Black	84084	84086

	D	2700K - 5700K	Dynamic White	Optic
				15 Spot -
				30 Flood -
				60 Flood -

Électronique

83159	99333	DMX	Driver CV
DALI DT8 2 - 4 art. p 270 x 1490 x h 225	Dimmer DMX 1 - 8 art.	Controllers Pag 952 - 953	CV 48V Pag 941

Warp_R | Downlight | arrayLED 15 W DC 400 mA

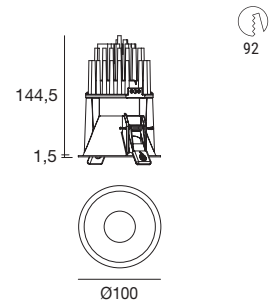

	CRI 92	CRI 92 HC	CRI 80	CRI 80 HC
White	90776	90780	90552	90778
Black	90777	90781	90553	90779

	Cct	lm S - D CRI 92	lm S - D CRI 80	Optic
M	2700	1568 - 1145	1932 - 1409	15 Spot (21°)
W	3000	1677 - 1223	1932 - 1409	30 Flood (38°)
N	4000	1804 - 1316	2078 - 1516	60 W.Flood (52°)

Électronique

99740	99739	99738
ON/OFF 1 art. p 134 x 137 x h 31	0/1-10V 1 art. p 134 x 137 x h 31	DALI PUSH 1 art. p 134 x 137 x h 31

DW **NEW** 15W DC 700 mA

	Dynamic White	HC Dynamic White
White	84087	84089
Black	84088	84090

	D	2700K - 5700K	Dynamic White	Optic
				15 Spot -
				30 Flood -
				60 W.Flood -

Électronique

83159	99333	DMX	Driver CV
DALI DT8 1 - 2 art. p 270 x 1490 x h 225	Dimmer DMX 1 - 2 art.	Controllers Pag 952 - 953	CV 48V Pag 941

WT 12 W DC 350 mA

	WarmTune
White	81481
Black	81482

	S	1800K>3000K WarmTune 1000 lm	Optic
			15 Spot (21°)
			30 Flood (38°)
			60 W.Flood (52°)

Électronique

99360	99361	99362
Triac + IGBT 1 art. p 150 x 143 x h 29	0/1-10V 1 art. p 150 x 143 x h 29	DALI_PUSH 1 art. p 150 x 143 x h 29





Warp_R | Downlight | arrayLED 25 W DC 700 mA

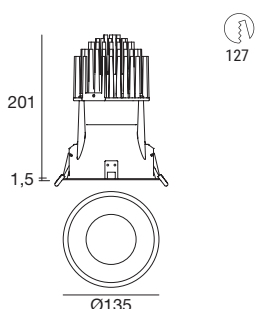

	CRI 92	CRI 92 HC	CRI 80	CRI 80 HC
White	90790	90794	90612	90792
Black	90791	90795	90613	90793

	Cct	lm S - D CRI 92	lm S - D CRI 80	Optic
M	2700	2598 - 1827	3210 - 2257	15 Spot (21°)
W	3000	2794 - 1965	3431 - 2413	30 Flood (34°)
N	4000	2990 - 2103	3431 - 2413	60 Flood (39°)

Électronique

99112	83066	99330
ON/OFF 1 art. p 103 x 1 58 x h 27	0/1-10V DALI PUSH 1 art. p 124 x 1 67 x h 22	DALI PUSH 1 art. p 210 x 1 48 x h 28

DW **NEW** 25 W DC 700 mA

	Dynamic White	HC Dynamic White
White	84091	84093
Black	84092	84094

		Optic
D	2700K - 5700K Dynamic White	15 Spot - 30 Flood - 60 W.Flood -

Électronique

83159	99333	DMX	Driver CV
DALI DT8 1 art. p 270 x 1 490 x h 225	Dimmer DMX 1 - 2 art.	Controllers Pag 952 - 953	CV 48V Pag 941

WT 25 W DC 700 mA

	WarmTune
White	91926
Black	91927

		Optic
S	1800K>3000K WarmTune 2100lm	15 Spot (21°) 30 Flood (34°) 60 Flood (39°)

Électronique

99360	99361	99362
Triac + IGBT 1 art. p 150 x 1 43 x h 29	0/1-10V 1 art. p 150 x 1 43 x h 29	DALI 1 art. p 150 x 1 43 x h 29

Warp_R | Downlight | arrayLED 45 W DC 1250 mA

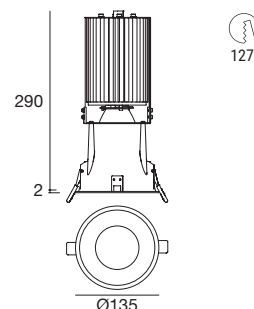

	CRI 92	CRI 92 HC	CRI 80	CRI 80 HC
White	81487	81491	81485	81489
Black	81488	81492	81486	81490

	Cct	lm S - D CRI 92	lm S - D CRI 80	Optic
M	2700	4884 - 3410	6002 - 4191	15 Spot (27°)
W	3000	5223 - 3647	6002 - 4191	30 Flood (34°)
N	4000	5616 - 3919	6452 - 4504	60 Flood (43°)

Électronique

83114	83066
ON/OFF 1 art. p 160 x 1 70 x h 36	0/1-10V DALI PUSH 1 art. p 124 x 1 67 x h 22

Warp_R PRO | Downlight | arrayLED 11 W DC 300 mA

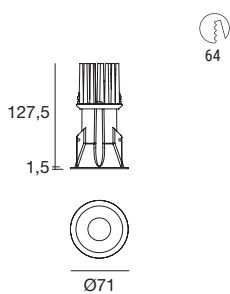

	CRI 92	CRI 80
White	83766	83764
Black	83767	83765

	Cct	lm S - D CRI 92	lm S - D CRI 80	Optic
M	2700	1165 - On req	1384 - On req	15 Spot -
W	3000	1220 - On req	1442 - On req	30 Flood -
N	4000	1311 - On req	1523 - On req	60 Flood -

Électronique

99734	99732	99730
ON/OFF 1 art. p 88 x 138 x h 23	0/1-10V 1 art. p 134 x 137 x h 31	DALI_PUSH 1 art. p 134 x 137 x h 31



Warp_R PRO | Downlight | arrayLED 15 W DC 400 mA

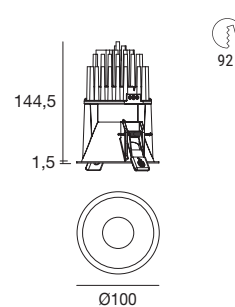

	CRI 92	CRI 80
White	83770	83768
Black	83771	83769

	Cct	lm S - D CRI 92	lm S - D CRI 80	Optic
M	2700	1568 - On req	1932 - On req	15 Spot -
W	3000	1677 - On req	1932 - On req	30 Flood -
N	4000	1804 - On req	2078 - On req	60 Flood -

Électronique

99740	99739	99738
ON/OFF 1 art. p 134 x 137 x h 31	0/1-10V 1 art. p 134 x 137 x h 31	DALI_PUSH 1 art. p 134 x 137 x h 31

Warp_R PRO | Downlight | arrayLED 25 W DC 700 mA

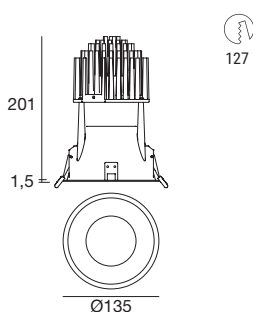

	CRI 92	CRI 80
White	83774	83772
Black	83775	83773

	Cct	lm S - D CRI 92	lm S - D CRI 80	Optic
M	2700	2598 - On req	3210 - On req	15 Spot -
W	3000	2794 - On req	3431 - On req	30 Flood -
N	4000	2990 - On req	3431 - On req	60 Flood -

Électronique

99112	83066	99330
ON/OFF 1 art. p 103 x 158 x h 27	0/1-10V DALI_PUSH 1 art. p 124 x 167 x h 22	DALI_PUSH 1 art. p 210 x 148 x h 28

Warp_RY | Downlight | powerLED 2 W DC 630 mA

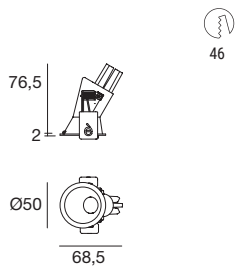

	CRI 92	CRI 92 HC	CRI 80	CRI 80 HC
White	90814	90818	90812	90816
Black	90815	90819	90813	90817

	Cct	lm S - D CRI 92	lm S - D CRI 80	Optic
M	2700	157 - 76	219 - 107	15 Spot (44°)
W	3000	179 - 87	233 - 113	30 Flood (45°)
N	4000	-	249 - 121	60 W.Flood (43°)

Électronique

89147	99376	99105	99710	99713	+ driver 24V DC 99374 75W 99331 150W
ON/OFF 1 - 2 art. p 138 x 122 x h 21	ON/OFF 3 - 6 art. p 138 x 122 x h 21	ON/OFF 6 - 12 art. p 103 x 158 x h 27	24V DC converter 0/1-10V 1 art. p 138 x 122 x h 21	24V DC converter DALI 1 art. p 138 x 122 x h 21	



Warp_RY | Downlight | powerLED 4 W DC 350 mA

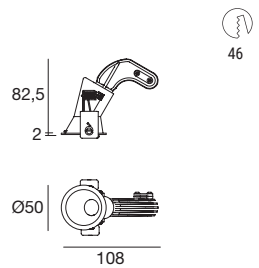

	CRI 92	CRI 92 HC	CRI 80	CRI 80 HC
White	90830	90834	90828	90832
Black	90831	90835	90829	90833

	Cct	lm S - D CRI 92	lm S - D CRI 80	Optic
M	2700	395 - 218	490 - 270	15 Spot (43°)
W	3000	423 - 233	490 - 270	30 Flood (46°)
N	4000	456 - 251	529 - 291	60 W.Flood (46°)

Électronique

89145	99375	99708	99711	+ driver 24V DC 99374 75W 99331 150W
ON/OFF 1 art. p 138 x 122 x h 21	ON/OFF 2 - 3 art. p 138 x 122 x h 21	0/1-10V converter 1 art. p 138 x 122 x h 21	DALI converter 1 art. p 138 x 122 x h 21	



Warp_RY | Downlight | powerLED 10 W DC 800 mA

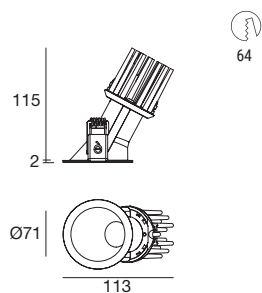

	CRI 92	CRI 92 HC	CRI 80	CRI 80 HC
White	90846	90850	90844	90848
Black	90847	90851	90845	90849

	Cct	lm S - D CRI 92	lm S - D CRI 80	Optic
M	2700	960 - 673	1108 - 777	15 Spot (41°)
W	3000	1034 - 725	1194 - 837	30 Flood (34°)
N	4000	1108 - 777	1280 - 898	60 W.Flood (43°)

Électronique

99735	99135	99733	99731	99345
ON/OFF 1 art. p 134 x 137 x h 31	ON/OFF 2 - 3 art. p 103 x 158 x h 27	0/1-10V 1 art. p 134 x 137 x h 31	DALI PUSH 1 art. p 134 x 137 x h 31	DALI PUSH 1 - 3 art. p 210 x 148 x h 25

Warp_RY | Downlight | arrayLED 15 W DC 400 mA

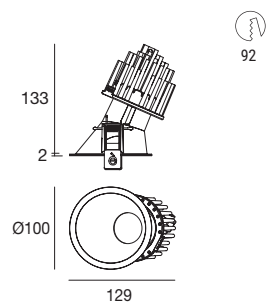

	CRI 92	CRI 92 HC	CRI 80	CRI 80 HC
White	90862	90866	90860	90864
Black	90863	90867	90861	90865

	Cct	lm S - D CRI 92	lm S - D CRI 80	Optic
M	2700	1568 - 1006	1932 - 1239	15 Spot (44°)
W	3000	1677 - 1075	1932 - 1239	30 Flood (41°)
N	4000	1804 - 1157	2078 - 1333	60 W.Flood (46°)

Électronique

99740	99739	99738
ON/OFF 1 art. p 134 x 137 x h 31	0/1-10V 1 art. p 134 x 137 x h 31	DALI PUSH 1 art. p 134 x 137 x h 31

Warp_RY | Downlight | arrayLED 25 W DC 700 mA

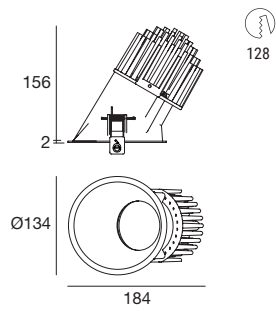

	CRI 92	CRI 92 HC	CRI 80	CRI 80 HC
White	90878	90882	90876	90880
Black	90879	90883	90877	90881

	Cct	lm S - D CRI 92	lm S - D CRI 80	Optic
M	2700	2598 - 1796	3210 - 2219	15 Spot (36°)
W	3000	2794 - 1932	3431 - 2309	30 Flood (34°)
N	4000	2990 - 2067	3431 - 2309	60 W.Flood (41°)

Électronique

99112	83066	99330
ON/OFF	0/1-10V DALI PUSH	DALI PUSH
1 art.	1 art.	1 art.
p 103 x l 158 x h 27	p 124 x l 67 x h 22	p 210 x l 48 x h 28

Warp_RJ | Downlight | powerLED 8 W DC 700 mA

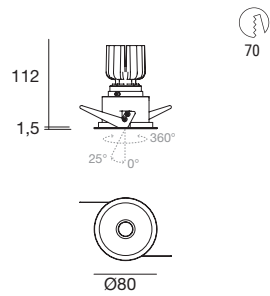

	CRI 92	CRI 80
White	81258	81260
Black	81259	81261

	Cct	lm S - D CRI 92	lm S - D CRI 80	Optic
M	2700	689 - 417	854 - 517	15 Spot (15°)
W	3000	738 - 446	854 - 517	30 Flood (31°)
N	4000	796 - 482	922 - 558	60 W.Flood (58°)

Électronique

99735	99147	99733	99731	99345
ON/OFF 1 art. p 134 x 137 x h 31	ON/OFF 2 - 3 art. p 103 x 158 x h 27	0/1-10V 1 art. p 134 x 137 x h 31	DALI PUSH 1 art. p 134 x 137 x h 31	DALI PSUH 1 - 3 art. p 210 x 148 x h 25

DW NEW 8 W DC 700 mA

Dynamic White	
White	84107
Black	84108

D	2700K - 5700K	Dynamic White	Optic
			15 Spot -
			30 Flood -
			60 W.Flood -

Électronique

83159	99333	DMX	Driver CV
DALI DT8 2 - 4 art. p 270 x 1490 x h 225	Dimmer DMX 1 - 8 art.	Controllers Pag 952 - 953	CV 48V Pag 941

Warp_RJ | Downlight | arrayLED 15 W DC 400 mA

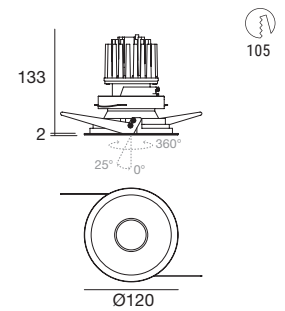

	CRI 92	CRI 80
White	81262	81264
Black	81263	81265

	Cct	lm S - D CRI 92	lm S - D CRI 80	Optic
M	2700	1568 - 1060	1932 - On req	15 Spot (23°)
W	3000	1677 - 1133	1932 - On req	30 Flood (36°)
N	4000	1804 - 1287	2078 - On req	60 W.Flood (56°)

Électronique

99740	99739	99738
ON/OFF 1 art. p 134 x 137 x h 31	0/1-10V 1 art. p 134 x 137 x h 31	DALI PUSH 1 art. p 134 x 137 x h 31

DW NEW 15 W DC 700 mA

Dynamic White	
White	84109
Black	84110

D	2700K - 5700K	Dynamic White	Optic
			15 Spot -
			30 Flood -
			60 W.Flood -

Électronique

83159	99333	DMX	Driver CV
DALI DT8 1 - 2 art. p 270 x 1490 x h 225	Dimmer DMX 1 - 2 art.	Controllers Pag 952 - 953	CV 48V Pag 941



Warp_Q | Downlight | powerLED 2 W DC 630 mA

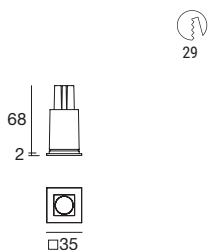

	CRI 92	CRI 92 ^{HC}	CRI 80	CRI 80 ^{HC}
White	90726	90730	90724	90728
Black	90727	90731	90725	90729

	Cct	lm S - D CRI 92	lm S - D CRI 80	Optic
M	2700	157 - 77	219 - 107	15 Spot (21°)
W	3000	179 - 88	233 - 114	30 Flood (28°)
N	4000	-	249 - 122	60 W.Flood (50°)

Électronique

89147	99376	99105	99710	99713	+ driver 24V DC 99374 75W 99331 150W
ON/OFF 1 - 2 art. p 138 x 122 x h 21	ON/OFF 3 - 6 art. p 138 x 122 x h 21	ON/OFF 6 - 12 art. p 103 x 158 x h 27	24V DC converter 0/1-10V 1 art. p 138 x 122 x h 21	24V DC converter DALI 1 art. p 138 x 122 x h 21	



Warp_Q | Downlight | powerLED 6 W DC 500 mA

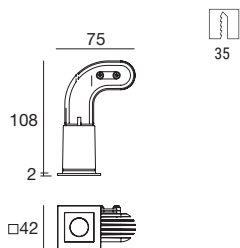

	CRI 92	CRI 92 ^{HC}	CRI 80	CRI 80 ^{HC}
White	90756	90760	90754	90758
Black	90757	90761	90755	90759

	Cct	lm S - D CRI 92	lm S - D CRI 80	Optic
M	2700	532 - 335	659 - 415	15 Spot (15°)
W	3000	569 - 358	659 - 415	30 Flood (32°)
N	4000	614 - 386	711 - 448	60 W.Flood (52°)

Électronique

99377	99106	99714	99715
ON/OFF 1 art. p 138 x 122 x h 21	ON/OFF 2-3 art. p 103 x 158 x h 27	0/1-10V 1 art. p 138 x 122 x h 21	DALI 1 art. p 138 x 122 x h 21



Warp_Q | Downlight | powerLED 4 W DC 350 mA

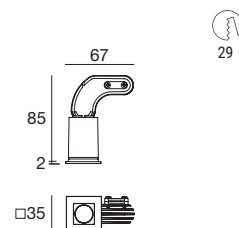

	CRI 92	CRI 92 ^{HC}	CRI 80	CRI 80 ^{HC}
White	90734	90738	90732	90736
Black	90735	90739	90733	90737

	Cct	lm S - D CRI 92	lm S - D CRI 80	Optic
M	2700	395 - 212	490 - 264	15 Spot (15°)
W	3000	423 - 228	490 - 264	30 Flood (30°)
N	4000	456 - 245	529 - 285	60 W.Flood (50°)

Électronique

89145	99375	99708	99711	+ driver 24V DC 99374 75W 99331 150W
ON/OFF 1 art. p 138 x 122 x h 21	ON/OFF 2 - 3 art. p 138 x 122 x h 21	0/1-10V converter 1 art. p 138 x 122 x h 21	DALI converter 1 art. p 138 x 122 x h 21	



Warp_Q | Downlight | powerLED 10 W DC 800 mA

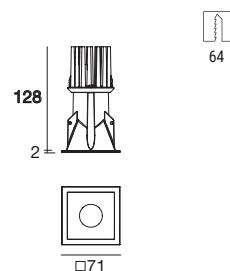

	CRI 92	CRI 92 ^{HC}	CRI 80	CRI 80 ^{HC}
White	90770	90774	90768	90772
Black	90771	90775	90769	90773

	Cct	lm S - D CRI 92	lm S - D CRI 80	Optic
M	2700	960 - 681	1108 - 785	15 Spot (18°)
W	3000	1034 - 734	1194 - 847	30 Flood (28°)
N	4000	1108 - 785	1280 - 907	60 W.Flood (46°)

Électronique

99735	99135	99733	99731	99345
ON/OFF 1 art. p 134 x 137 x h 31	ON/OFF 2 - 3 art. p 103 x 158 x h 27	0/1-10V 1 art. p 134 x 137 x h 31	DALI PUSH 1 art. p 134 x 137 x h 31	DALI PUSH 1 - 3 art. p 210 x 148 x h 25

DW ^{NEW} 8 W DC 700 mA

	Dynamic White	^{HC} Dynamic White
White	84095	84097
Black	84096	84098

D	2700K - 5700K	Dynamic White	Optic
			15 Spot -
			30 Flood -
			60 W.Flood -

Électronique

83159	99333	DMX	Driver CV
DALI DT8 2 - 4 art. p 270 x 1490 x h 225	Dimmer DMX 1 - 8 art.	Controllers Pag 952 - 953	CV 48V Pag 941

Warp_Q | Downlight | arrayLED 15 W DC 400 mA

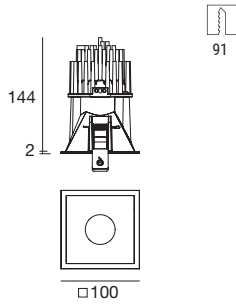

	CRI 92	CRI 92 HC	CRI 80	CRI 80 HC
White	90784	90788	90782	90786
Black	90785	90789	90783	90787

	Cct	lm S - D CRI 92	lm S - D CRI 80	Optic
M	2700	1568 - 1146	1932 - 1412	15 Spot (22°)
W	3000	1677 - 1226	1932 - 1412	30 Flood (38°)
N	4000	1804 - 1320	2078 - 1519	60 W.Flood (53°)

Électronique

99740	99739	99738
ON/OFF 1 art. p 134 x l 137 x h 31	0/1-10V 1 art. p 134 x l 137 x h 31	DALI PUSH 1 art. p 134 x l 137 x h 31

DW NEW 15 W DC 700 mA

	Dynamic White	HC Dynamic White
White	84099	84101
Black	84100	84102

	D	2700K - 5700K	Dynamic White	Optic
				15 Spot -
				30 Flood -
				60 W.Flood -

Électronique

83159	99333	DMX	Driver CV
DALI DT8 1 - 2 art. p 270 x l 490 x h 225	Dimmer DMX 1 - 2 art.	Controllers Pag 952 - 953	CV 48V Pag 941

Warp_Q | Downlight | powerLED 25 W DC 700 mA

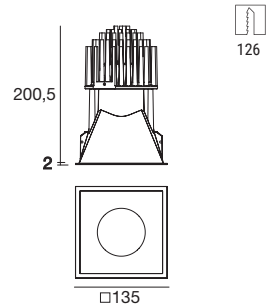

	CRI 92	CRI 92 HC	CRI 80	CRI 80 HC
White	90798	90802	90796	90800
Black	90799	90803	90797	90801

	Cct	lm S - D CRI 92	lm S - D CRI 80	Optic
M	2700	2598 - 1905	3210 - 2354	15 Spot (22°)
W	3000	2794 - 2049	3431 - 2515	30 Flood (38°)
N	4000	2990 - 2191	3431 - 2515	60 W.Flood (50°)

Électronique

99112	83066	99330
ON/OFF 1 art. p 103 x l 58 x h 27	0/1-10V DALI PUSH 1 art. p 124 x l 67 x h 22	DALI PUSH 1 art. p 210 x l 48 x h 28

DW NEW 25 W DC 700 mA

	Dynamic White	HC Dynamic White
White	84103	84105
Black	84104	84106

	D	2700K - 5700K	Dynamic White	Optic
				15 Spot -
				30 Flood -
				60 W.Flood -

Électronique

83159	99333	DMX	Driver CV
DALI DT8 1 art. p 270 x l 490 x h 225	Dimmer DMX 1 - 2 art.	Controllers Pag 952 - 953	CV 48V Pag 941

Warp_QY | Downlight | powerLED 2 W DC 630 mA

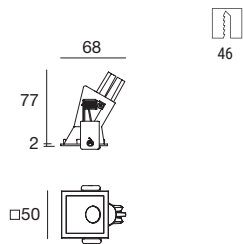

	CRI 92	CRI 92 ^{HC}	CRI 80	CRI 80 ^{HC}
White	90822	90826	90820	90824
Black	90823	90827	90821	90825

	Cct	lm S - D CRI 92	lm S - D CRI 80	Optic
M	2700	157 - 82	219 - 114	15 Spot (52°)
W	3000	179 - 94	233 - 122	30 Flood (52°)
N	4000	-	249 - 130	60 W.Flood (48°)

Électronique

89147	99376	99105	99710	99713	+ driver 24V DC 99374 75W 99331 150W
ON/OFF 1 - 2 art. p 138 x 122 x h 21	ON/OFF 3 - 6 art. p 138 x 122 x h 21	ON/OFF 6 - 12 art. p 103 x 158 x h 27	24V DC converter 0/1-10V 1 art. p 138 x 122 x h 21	24V DC converter DALI 1 art. p 138 x 122 x h 21	



Warp_QY | Downlight | powerLED 10 W DC 800 mA

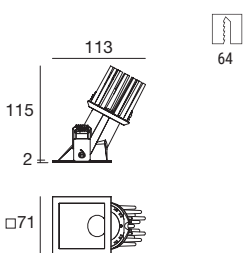

	CRI 92	CRI 92 ^{HC}	CRI 80	CRI 80 ^{HC}
White	90854	90858	90852	90856
Black	90855	90859	90853	90857

	Cct	lm S - D CRI 92	lm S - D CRI 80	Optic
M	2700	960 - 674	1108 - 778	15 Spot (22°)
W	3000	1034 - 724	1194 - 837	30 Flood (38°)
N	4000	1108 - 777	1280 - 897	60 W.Flood (50°)

Électronique

99735	99135	99733	99731	99345
ON/OFF 1 art. p 134 x 137 x h 31	ON/OFF 2 - 3 art. p 103 x 158 x h 27	0/1-10V 1 art. p 134 x 137 x h 31	DALI PUSH 1 art. p 134 x 137 x h 31	DALI PUSH 1 - 3 art. p 210 x 148 x h 25

Warp_QY | Downlight | powerLED 4 W DC 350 mA

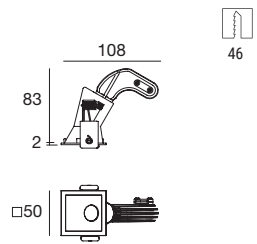

	CRI 92	CRI 92 ^{HC}	CRI 80	CRI 80 ^{HC}
White	90838	90842	90836	90840
Black	90839	90843	90837	90841

	Cct	lm S - D CRI 92	lm S - D CRI 80	Optic
M	2700	395 - 233	490 - 289	15 Spot (22°)
W	3000	423 - 249	490 - 289	30 Flood (38°)
N	4000	456 - 269	529 - 312	60 W.Flood (50°)

Électronique

89145	99375	99708	99711	+ driver 24V DC 99374 75W 99331 150W
ON/OFF 1 art. p 138 x 122 x h 21	ON/OFF 2 - 3 art. p 138 x 122 x h 21	0/1-10V converter 1 art. p 138 x 122 x h 21	DALI converter 1 art. p 138 x 122 x h 21	



Warp_QY | Downlight | arrayLED 15 W DC 400 mA

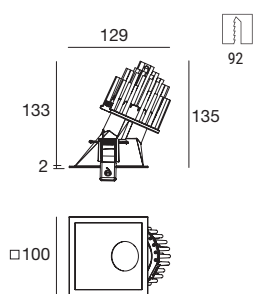

	CRI 92	CRI 92 ^{HC}	CRI 80	CRI 80 ^{HC}
White	90870	90874	90868	90872
Black	90871	90875	90869	90873

	Cct	lm S - D CRI 92	lm S - D CRI 80	Optic
M	2700	1568 - 1120	1932 - 1381	15 Spot (22°)
W	3000	1677 - 1198	1932 - 1381	30 Flood (38°)
N	4000	1804 - 1290	2078 - 1485	60 W.Flood (50°)

Électronique

99740	99739	99738
ON/OFF 1 art. p 134 x 137 x h 31	0/1-10V 1 art. p 134 x 137 x h 31	DALI PUSH 1 art. p 134 x 137 x h 31

Warp_QY | Downlight | arrayLED 25 W DC 700 mA

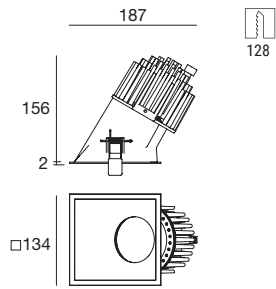

	CRI 92	CRI 92 HC	CRI 80	CRI 80 HC
White	90886	90890	90884	90888
Black	90887	90891	90885	90889

	Cct	lm S - D CRI 92	lm S - D CRI 80	Optic
M	2700	2598 - 1928	3210 - 2382	15 Spot (22°)
W	3000	2794 - 2073	3431 - 2546	30 Flood (38°)
N	4000	2990 - 2219	3431 - 2546	60 W.Flood (50°)

Électronique

99112	83066	99330
ON/OFF	0/1-10V DALI PUSH	DALI PUSH
1 art.	1 art.	1 art.
p 103 x l 58 x h 27	p 124 x l 67 x h 22	p 210 x l 48 x h 28



epitax

Matériaux

Corps en aluminium

Corps en polycarbonate (versions 8 W et 15 W)



epitax range



	Round	J Round Adjustable
2 W	Ø 29 mm	-
4 W	Ø 29 mm	-
6 W	Ø 35 mm	-
8 W	-	Ø 64 mm
10 W	Ø 64 mm	-
15 W	Ø 88 mm	Ø 88 mm
Finish	<input type="checkbox"/> White <input checked="" type="checkbox"/> Black <input type="checkbox"/> Gold	<input type="checkbox"/> White <input checked="" type="checkbox"/> Black <input type="checkbox"/> Gold
Balance CRI 92	(2W) 2700K - 3000K 2700K - 3000K - 4000K	2700K - 3000K - 4000K
Efficiency CRI 80	2700K - 3000K - 4000K	2700K - 3000K - 4000K
WarmTune 1800K - 3000K	10 W - 15 W	-
Optics	Narrow Spot - Spot Flood - Wide Flood	Narrow Spot - Spot Flood - Wide Flood
Driver	On/Off - 1/10V - DALI - Fase-Cut	On/Off - 1/10V - DALI
	35/37 mm - 40 mm 73/76 mm - - 102/105 mm	73/76 mm -102/105 mm

Trimless

Les Downlights de la famille Epitax peuvent être encastrés à ras ou extraits en position semi-rétractée également sur des installations déjà existantes : cette possibilité simplifie énormément l'opération d'extraction et donne à Epitax un caractère versatile et facile à configurer.



Source en retrait

La source lumineuse particulièrement en retrait permet de réduire l'incidence du faisceau lumineux secondaire et d'obtenir ainsi une émission définie et un éblouissement considérablement diminué.

Finitions

Trois finitions disponibles:

- blanc RAL9003
- noir RAL9005
- or warm & chic

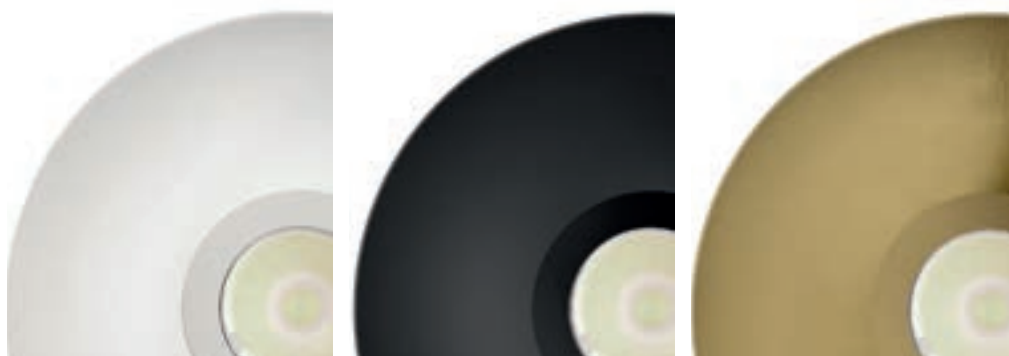

Version orientable

Les versions Epitax_J peuvent pivoter horizontalement à 360° et s'incliner à 30° des deux côtés par rapport à la verticale.



La technologie Warm Tune™ rappelle l'effet nostalgique des lampes à incandescence : lorsque l'intensité diminue, la lumière devient plus chaude et plus douce, jusqu'à atteindre l'effet bougie. La source arrayLED utilisée garantit un indice de rendu des couleurs (CRI 92) élevé : ces caractéristiques se vérifient lorsque l'intensité de la lampe est réglée aussi bien au maximum (température de couleur de 3000 K) qu'au minimum (température de couleur de 1800 K).

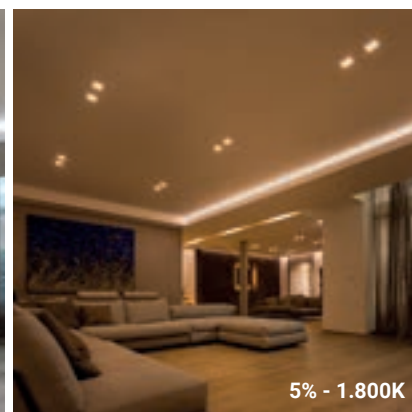
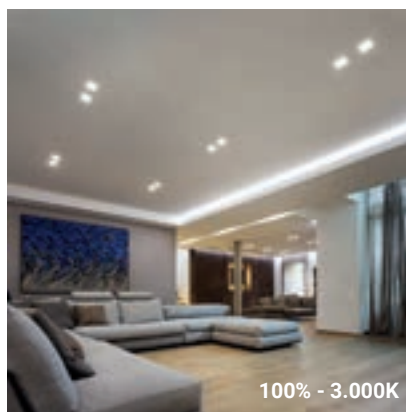

Epitax | Downlight | powerLED 2 W DC 630 mA

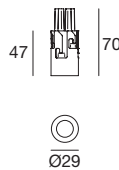

	CRI 92	CRI 80
White	80632	80630
Black	80633	80631
Gold	80745	80744

	Cct	lm S - D CRI 92	lm S - D CRI 80	Optic
M	2700	157 - 97	219 - 136	8 N.Spot (11°)
W	3000	179 - 111	233 - 145	15 Spot (22°)
N	4000	-	249 - 155	30 Flood (27°) 60 W.Flood (52°)

Électronique

89147	99376	99105	99710	99713	+ driver 24V DC 99374 75W 99331 150W
ON/OFF 1 - 2 art. p 138 x l 22 x h 21	ON/OFF 3 - 6 art. p 138 x l 22 x h 21	ON/OFF 6 - 12 art. p 103 x l 58 x h 27	24V DC converter 0/1-10V 1 art. p 138 x l 22 x h 21	24V DC converter DALI 1 art. p 138 x l 22 x h 21	



Boîtier à encastrement pour installation affleurante Pag. 64

98501 H. 28 Ø 39 mm

Boîtier à encastrement avec bride Pag. 64

98527 H. 27 Ø 42 mm	White
98528 H. 27 Ø 42 mm	Black
98529 H. 27 Ø 42 mm	Gold

Epitax | Downlight | powerLED 4 W DC 350 mA

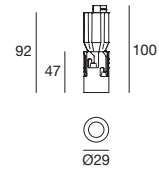

	CRI 92	CRI 80
White	80636	80634
Black	80637	80635
Gold	80747	80746

	Cct	lm S - D CRI 92	lm S - D CRI 80	Optic
M	2700	395 - 226	490 - 281	15 Spot (15°)
W	3000	423 - 243	490 - 281	30 Flood (31°)
N	4000	456 - 261	529 - 303	60 W.Flood (49°)

Électronique

89145	99375	99708	99711	+ driver 24V DC 99374 75W 99331 150W
ON/OFF 1 art. p 138 x l 22 x h 21	ON/OFF 2 - 3 art. p 138 x l 22 x h 21	0/1-10V converter 1 art. p 138 x l 22 x h 21	DALI converter 1 art. p 138 x l 22 x h 21	



Boîtier à encastrement pour installation affleurante Pag. 64

98501 H. 28 Ø 39 mm

Boîtier à encastrement avec bride Pag. 64

98527 H. 27 Ø 42 mm	White
98528 H. 27 Ø 42 mm	Black
98529 H. 27 Ø 42 mm	Gold

Epitax | Downlight | powerLED 6 W DC 500 mA

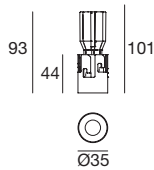

	CRI 92	CRI 80
White	80640	80638
Black	80641	80639
Gold	80749	80748

	Cct	lm S - D CRI 92	lm S - D CRI 80	Optic
M	2700	532 - 327	659 - 405	15 Spot (15°)
W	3000	569 - 351	659 - 405	30 Flood (33°)
N	4000	614 - 377	711 - 437	60 W.Flood (53°)

Électronique

99377	99106	99714	99715
ON/OFF 1 art. p 138 x l 22 x h 21	ON/OFF 2-3 art. p 103 x l 58 x h 27	0/1-10V 1 art. p 138 x l 22 x h 21	DALI 1 art. p 138 x l 22 x h 21



Boîtier à encastrer pour installation affleurante Pag. 64

98502 H. 28 Ø 43 mm

Boîtier à encastrer avec bride Pag. 64

98530 H. 28 Ø 48 mm	White
98531 H. 28 Ø 48 mm	Black
98532 H. 28 Ø 48 mm	Gold

RTG 80638W15 / 80638W30 / 80638W60

Epitax | Downlight | powerLED 10 W DC 800 mA

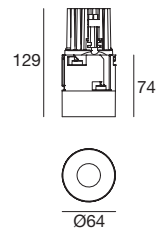

	CRI 92	CRI 80
White	80595	80591
Black	80596	80592
Gold	80751	80750

	Cct	lm S - D CRI 92	lm S - D CRI 80	Optic
M	2700	960 - 633	1108 - 731	15 Spot (17°)
W	3000	1034 - 681	1194 - 787	30 Flood (28°)
N	4000	1108 - 731	1280 - 844	45 W.Flood (42°)

Électronique

99735	99135	99733	99731	99345
ON/OFF 1 art. p 134 x l 37 x h 31	ON/OFF 2-3 art. p 103 x l 58 x h 27	0/1-10V 1 art. p 134 x l 37 x h 31	DALI PUSH 1 art. p 134 x l 37 x h 31	DALI PUSH 1-3 art. p 210 x l 48 x h 25

WT 8 W DC 250 mA

	WarmTune
White	81514
Black	81515

	Optic
S	1800K>3000K WarmTune 700 lm
	30 Flood -
	60 W.Flood -

Électronique

99360	99361	99362
Triac + IGBT 1 art. p 150 x l 43 x h 29	0/1-10V 1 art. p 150 x l 43 x h 29	DALI 1 art. p 150 x l 43 x h 29

Boîtier à encastrer pour installation affleurante Pag. 64

98499 H. 42 Ø 73,5 mm

Boîtier à encastrer avec bride Pag. 64

98533 H. 42 Ø 84 mm	White
98534 H. 42 Ø 84 mm	Black
98535 H. 42 Ø 84 mm	Gold

RTG 80591W30 / 80591W60

Epitax | Downlight | arrayLED 15 W DC 400 mA

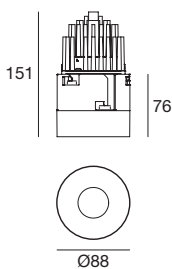

	CRI 92	CRI 80
White	80603	80599
Black	80604	80600
Gold	80753	80752

	Cct	lm S - D CRI 92	lm S - D CRI 80	Optic
M	2700	1568 - 1035	1932 - 1275	15 Spot (22°)
W	3000	1677 - 1107	1932 - 1275	30 Flood (37°)
N	4000	1804 - 1190	2078 - 1371	60 W.Flood (50°)

Électronique

99740	99739	99738
ON/OFF 1 art. p 134 x l 37 x h 31	0/1-10V 1 art. p 134 x l 37 x h 31	DALI PUSH 1 art. p 134 x l 37 x h 31

WT 12 W DC 350 mA

WarmTune	
White	81516
Black	81517

	Optic
S 1800K>3000K WarmTune 1000 lm	15 Spot -
	30 Flood -
	60 W.Flood -

Électronique

99360	99361	99362
Triac + IGBT 1 art. p 150 x l 43 x h 29	0/1-10V 1 art. p 150 x l 43 x h 29	DALI PUSH 1 art. p 150 x l 43 x h 29

Boîtier à encastrement pour installation affleurante Pag. 64

98500 H. 81 Ø 89,5 mm

Boîtier à encastrement avec bride Pag. 64

98536 H. 42,5 Ø 110 mm	White
98537 H. 42,5 Ø 110 mm	Black
98538 H. 42,5 Ø 110 mm	Gold

Epitax_J | Downlight | powerLED 8 W DC 700 mA

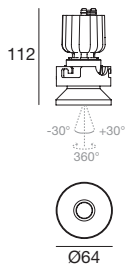

	CRI 92	CRI 80
White	80644	80642
Black	80645	80643
Gold	80758	80757

	Cct	lm S - D CRI 92	lm S - D CRI 80	Optic
M	2700	689 - 411	854 - 509	15 Spot (15°)
W	3000	738 - 440	854 - 509	30 Flood (28°)
N	4000	796 - 475	922 - 550	60 W.Flood (42°)

Électronique

99735	99147	99733	99731	99345
ON/OFF 1 art. p 134 x 137 x h 31	ON/OFF 2 - 3 art. p 103 x 158 x h 27	0/1-10V 1 art. p 134 x 137 x h 31	DALI PUSH 1 art. p 134 x 137 x h 31	DALI PSUH 1 - 3 art. p 210 x 148 x h 25

Boîtier à encastrement pour installation affleurante Pag. 64

98499 H. 42 Ø 73,5 mm

Boîtier à encastrement avec bride Pag. 64

98533 H. 42 Ø 84 mm	White
98534 H. 42 Ø 84 mm	Black
98535 H. 42 Ø 84 mm	Gold

Epitax_J | Downlight | powerLED 15 W DC 400 mA

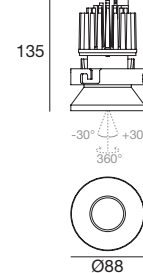

	CRI 92	CRI 80
White	80648	80646
Black	80649	80647
Gold	80760	80759

	Cct	lm S - D CRI 92	lm S - D CRI 80	Optic
M	2700	1568 - On req	1932 - On req	15 Spot (17°)
W	3000	1677 - On req	1932 - On req	30 Flood (28°)
N	4000	1804 - On req	2078 - On req	60 W.Flood(42°)

Électronique

99740	99739	99738
ON/OFF 1 art. p 134 x 137 x h 31	0/1-10V 1 art. p 134 x 137 x h 31	DALI PUSH 1 art. p 134 x 137 x h 31

Boîtier à encastrement pour installation affleurante Pag. 64

98500 H. 81 Ø 89,5 mm

Boîtier à encastrement avec bride Pag. 64

98536 H. 42,5 Ø 110 mm	White
98537 H. 42,5 Ø 110 mm	Black
98538 H. 42,5 Ø 110 mm	Gold

Boîtier d'encastrement

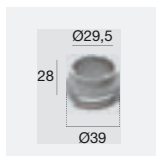

description	
98501	Boîtier d'encastrement pour installation affleurante
suitable for: Epitax 2W / Epitax 4W	

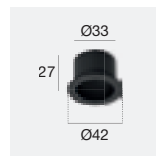

description		type
98527	Boîtier d'encastrement avec bride	<input type="checkbox"/> White
98528		<input checked="" type="checkbox"/> Black
98529		<input checked="" type="checkbox"/> Gold
suitable for: Epitax 2W / Epitax 4W		

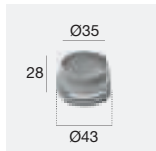

description	
98502	Boîtier d'encastrement pour installation affleurante
suitable for: Epitax 6W	

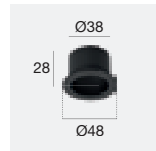

description		type
98530	Boîtier d'encastrement avec bride	<input type="checkbox"/> White
98531		<input checked="" type="checkbox"/> Black
98532		<input checked="" type="checkbox"/> Gold
suitable for: Epitax 6W		

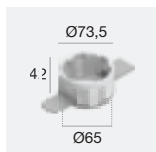

description	
98499	Boîtier d'encastrement pour installation affleurante
suitable for: Epitax 10W / Epitax 8W / Epitax_J 8W	

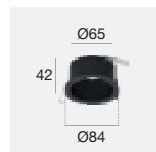

description		type
98533	Boîtier d'encastrement avec bride	<input type="checkbox"/> White
98534		<input checked="" type="checkbox"/> Black
98535		<input checked="" type="checkbox"/> Gold
suitable for: Epitax 10W / Epitax 8W / Epitax_J 8W		

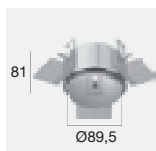

description	
98500	Boîtier d'encastrement pour installation affleurante
suitable for: Epitax 15W / Epitax_J 15W	

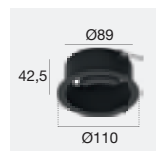

description		type
98536	Boîtier d'encastrement avec bride	<input type="checkbox"/> White
98537		<input checked="" type="checkbox"/> Black
98538		<input checked="" type="checkbox"/> Gold
suitable for: Epitax 15W / Epitax_J 15W		



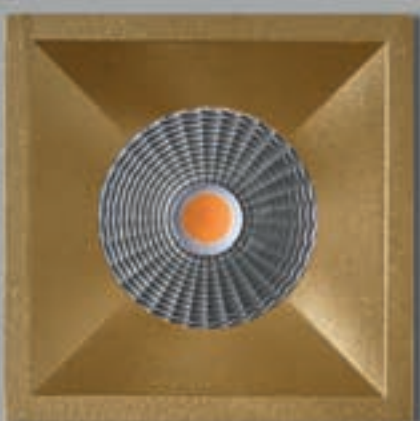
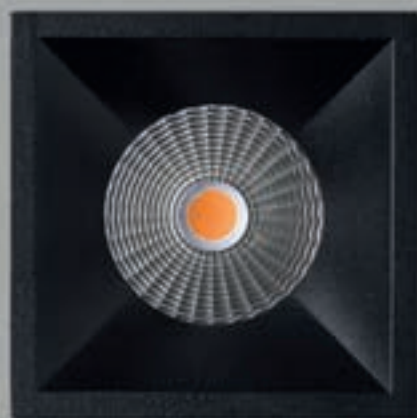

loro

Matériaux
Corps en aluminium



loro range



	_R Round	_RJ Round Adjustable	_Q Square	_QJ Square Adjustable																
4 W	-	Ø 69 mm	-	-																
8 W	Ø 76 mm	Ø 100 mm	□ 70 mm	□ 100 mm																
13 W	Ø 76 mm	Ø 100 mm	□ 70 mm	□ 100 mm																
25 W	Ø 105 mm	Ø 139 mm	□ 100 mm	□ 139 mm																
HC Accessories	8W - 13W - 25W	4W - 8W - 13W - 25W	8W - 13W - 25W	8W - 13W - 25W																
Finish	<table border="1"> <tr> <td>White</td> <td>Black</td> </tr> <tr> <td>Grey</td> <td>Gold</td> </tr> </table>	White	Black	Grey	Gold	<table border="1"> <tr> <td>White</td> <td>Black</td> </tr> <tr> <td>Grey</td> <td>Gold</td> </tr> </table>	White	Black	Grey	Gold	<table border="1"> <tr> <td>White</td> <td>Black</td> </tr> <tr> <td>Grey</td> <td>Gold</td> </tr> </table>	White	Black	Grey	Gold	<table border="1"> <tr> <td>White</td> <td>Black</td> </tr> <tr> <td>Grey</td> <td>Gold</td> </tr> </table>	White	Black	Grey	Gold
White	Black																			
Grey	Gold																			
White	Black																			
Grey	Gold																			
White	Black																			
Grey	Gold																			
White	Black																			
Grey	Gold																			
Balance CRI 92	2700K - 3000K - 4000K	2700K - 3000K - 4000K	2700K - 3000K - 4000K	2700K - 3000K - 4000K																
Efficiency CRI 80	2700K - 3000K - 4000K	2700K - 3000K - 4000K	2700K - 3000K - 4000K	2700K - 3000K - 4000K																
DynamicWhite 2700K - 5700K	Ø 76 mm - Ø 105 mm	Ø 100 mm - Ø 139 mm	□ 70 mm - □ 100 mm	□ 100 mm - □ 139 mm																
Optics	Spot - Flood - Wide Flood	Spot - Flood - Wide Flood	Spot - Flood - Wide Flood	Spot - Flood - Wide Flood																
Driver	On/Off - 1/10V - DALI	On/Off - 1/10V - DALI	On/Off - 1/10V - DALI	On/Off - 1/10V - DALI																
	68 mm - 95 mm	62 mm - 92 mm - 127 mm	□ 64 mm - □ 93 mm	□ 91 mm - □ 124 mm																

Encombrement minimal

L'utilisation d'un dissipateur arrière courbé réduit la profondeur d'encastrement et permet aux downlights de la famille Loro (à l'exception des versions 25 W) de s'adapter à l'installation sur des faux plafonds d'une hauteur inférieure à 10 cm.

UGR<19

Le groupe optique, composé d'un réflecteur chromé et d'un diffuseur en polycarbonate transparent, garantit un excellent contrôle de la réflectance et un indice UGR inférieur à 19 correspondant à la valeur seuil pour un bon éclairage des bureaux et selon les prescriptions minimales de santé et de sécurité relatives au travail sur équipement à écran de visualisation (norme UNI-EN 12464-1).



IP65 O.C.

Le groupe optique garantit un indice de protection frontale égal à IP65, c'est-à-dire une protection totale contre la pénétration de poussières et de particules extrêmement fines, ainsi que contre les projections d'eau.

ATTENTION : la valeur se réfère uniquement au bloc optique et NON au corps de la lampe (indice de protection IP44).



IP44
IP65

Finitions

Quatre finitions disponibles :

- blanc RAL9003
- noir RAL9005
- gris RAL9006
- or warm & chic



Filtre esthétique

Le nouveau type de filtre optique, conçu spécifiquement pour masquer la LED à l'intérieur du produit, constitue une amélioration esthétique et confère au downlight une plus grande propreté stylistique, les performances lumineuses demeurant inchangées.



Produit avec filtre
97920W33



Produit sans filtre
97920W30

Loro_R | Downlight | arrayLED 8 W DC 220 mA

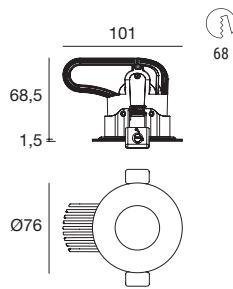

	CRI 92	CRI 92 HC	CRI 80	CRI 80 HC
White	97920	80791	97695	80787
Black	97921	80792	97696	80788
Grey	97924	80793	97697	80789
Gold	97925	80794	97698	80790

	Cct	lm S - D CRI 92	lm S - D CRI 80	Optic
M	2700	883 - 652	1088 - 867	15 Spot (15°)
W	3000	943 - 699	1088 - 928	30 Flood (34°)
N	4000	1016 - 753	1173 - 928	60 W.Flood (55°)
				33* W.Flood -

Électronique

99198	99732	99730
ON/OFF	0/1-10V	DALI PUSH
1 art.	1 art.	1 art.
p 134 x 137 x h 31	p 134 x 137 x h 31	p 134 x 137 x h 31

RTG 97695W30 / 97695W60

* Filtre esthétique



Loro_R avec filtre esthétique (33), disponible seulement pour les codes sans Honeycomb

Loro_R | Downlight | arrayLED 13 W DC 350 mA

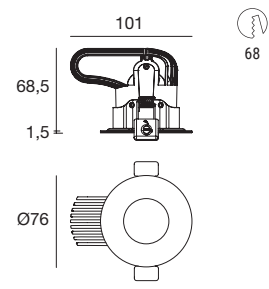

	CRI 92	CRI 92 HC	CRI 80	CRI 80 HC
White	91749	80799	91204	80795
Black	91750	80800	91205	80796
Grey	91751	80801	91206	80797
Gold	91752	80802	91207	80798

	Cct	lm S - D CRI 92	lm S - D CRI 80	Optic
M	2700	1399 - 813	1724 - 1081	15 Spot (8°)
W	3000	1496 - 871	1724 - 1156	30 Flood (18°)
N	4000	1610 - 938	1854 - 1156	60 W.Flood (54°)
				33* W.Flood -

Électronique

99260	99262	99721
ON/OFF	0/1-10V	DALI PUSH
1 art.	1 art.	1 art.
p 134 x 137 x h 31	p 210 x 148 x h 25	p 210 x 148 x h 25

DW 15 W DC 700 mA

	Dynamic White	HC Dynamic White
White	84111	84115
Black	84112	84116
Grey	84113	84117
Gold	84114	84118

	2700K - 5700K	Dynamic White	Optic
D			15 Spot -
			30 Flood -
			45 W.Flood -

Électronique

83159	99333	DMX	Driver CV
DALI DT8	Dimmer DMX	Controllers	CV 48V
1 - 2 art.	1 - 2 art.	Pag 952 - 953	Pag 941
p 270 x 1490 x h 225			

RTG 91204W30 / 91204W60

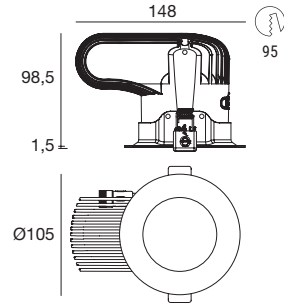

	CRI 92	CRI 92 HC	CRI 80	CRI 80 HC
White	80672	80807	80670	80803
Black	80673	80808	80671	80804
Grey	80704	80809	80702	80805
Gold	80705	80810	80703	80806

	Cct	18W lm S - D CRI 92	18W lm S - D CRI 80	Optic
M	2700	1901 - On req.	2349 - On req.	15 Spot (15°)
W	3000	2044 - On req.	2510 - On req.	30 Flood (34°)
N	4000	2188 - On req.	2510 - On req.	60 W.Flood (56°)

	Cct	25W lm S - D CRI 92	25W lm S - D CRI 80	Optic
M	2700	2598 - 1958	3210 - 2451	15 Spot (15°)
W	3000	2794 - 2134	3431 - 2621	30 Flood (34°)
N	4000	2990 - 2283	3431 - 2620	60 W.Flood (56°)

Électronique 18W

99106	99115	99344
ON/OFF 1 art. p 103 x 158 x h 27	0/1-10V 1 art. p 210 x 148 x h 28	DALI PUSH 1 art. p 210 x 148 x h 28

Électronique 25W

99112	83066	99330
ON/OFF 1 art. p 103 x 158 x h 27	0/1-10V DALI PUSH 1 art. p 124 x 167 x h 22	DALI PUSH 1 art. p 210 x 148 x h 28

DW 25 W DC 700 mA

	Dynamic White	HC Dynamic White
White	84119	84123
Black	84120	84124
Grey	84121	84125
Gold	84122	84126

			Optic
D	2700K - 5700K	Dynamic White	15 Spot -
			30 Flood -
			45 W.Flood -

Électronique

83159	99333	DMX	Driver CV
DALI DT8 1 art. p 270 x 1490 x h 225	Dimmer DMX 1 - 2 art.	Controllers Pag 952 - 953	CV 48V Pag 941

Loro_RJ | Downlight | powerLED 4 W DC 350 mA

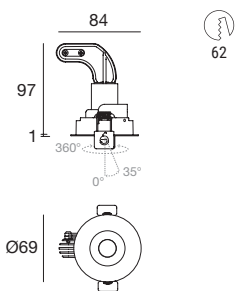

	CRI 92	CRI 92 HC	CRI 80	CRI 80 HC
White	80710	80847	80706	80843
Black	80711	80848	80707	80844
Grey	80712	80849	80708	80845
Gold	80713	80850	80709	80846

	Cct	lm S - D CRI 92	lm S - D CRI 80	Optic
M	2700	395 - 230	490 - 287	15 Spot (15°)
W	3000	423 - 247	490 - 287	30 Flood (31°)
N	4000	456 - 267	529 - 309	60 W.Flood (49°)

Électronique

89145	99375	99708	99711	+ driver 24V DC
ON/OFF 1 art. p 138 x 122 x h 21	ON/OFF 2 - 3 art. p 138 x 122 x h 21	0/1-10V converter 1 art. p 138 x 122 x h 21	DALI converter 1 art. p 138 x 122 x h 21	DC 99374 75W 99331 150W



Loro_RJ | Downlight | arrayLED 8 W DC 220 mA

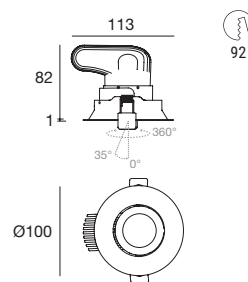

	CRI 92	CRI 92 HC	CRI 80	CRI 80 HC
White	93443	80855	93407	80851
Black	93444	80856	93411	80852
Grey	93446	80857	93413	80853
Gold	93449	80858	93418	80854

	Cct	lm S - D CRI 92	lm S - D CRI 80	Optic
M	2700	883 - 637	1088 - 785	15 Spot (17°)
W	3000	943 - 682	1088 - 785	30 Flood (22°)
N	4000	1016 - 734	1173 - 847	60 W.Flood (44°)
				33* W.Flood -

Électronique

99198	99732	99730
ON/OFF 1 art. p 134 x 137 x h 31	0/1-10V 1 art. p 134 x 137 x h 31	DALI PUSH 1 art. p 134 x 137 x h 31

RTG 93407W30 / 93407W60

*** Filtre esthétique**



Loro_RJ avec filtre esthétique (33), disponible seulement pour les codes sans Honeycomb

Loro_RJ | Downlight | arrayLED 13 W DC 350 mA

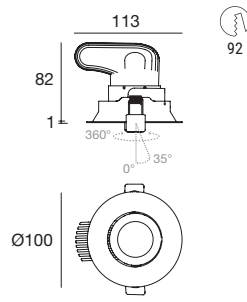

	CRI 92	CRI 92 HC	CRI 80	CRI 80 HC
White	93450	80863	93422	80859
Black	93451	80864	93428	80860
Grey	93452	80865	93429	80861
Gold	93460	80866	93431	80862

	Cct	lm S - D CRI 92	lm S - D CRI 80	Optic
M	2700	1399 - 1182	1724 - 1457	15 Spot (18°)
W	3000	1496 - 1265	1724 - 1457	30 Flood (23°)
N	4000	1610 - 1360	1854 - 1566	60 W.Flood (47°)
				33* W.Flood -

Électronique

99260	99262	99721
ON/OFF 1 art. p 134 x 137 x h 31	0/1-10V 1 art. p 210 x 148 x h 25	DALI PUSH 1 art. p 210 x 148 x h 25

Loro_RJ | Downlight | arrayLED 18W DC 500 mA - 25W DC 700 mA

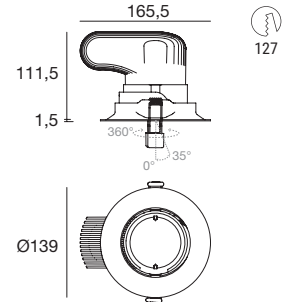

	CRI 92	CRI 92 HC	CRI 80	CRI 80 HC
White	80370	80871	80374	80867
Black	80371	80872	80375	80868
Grey	80372	80873	80376	80869
Gold	80373	80874	80377	80870

	Cct	18W lm S - D CRI 92	18W lm S - D CRI 80	Optic
M	2700	1901 - On req.	2349 - On req.	15 Spot (15°)
W	3000	2044 - On req.	2510 - On req.	30 Flood (34°)
N	4000	2188 - On req.	2510 - On req.	60 W.Flood (56°)

	Cct	25W lm S - D CRI 92	25W lm S - D CRI 80	Optic
M	2700	2598 - 1985	3210 - 2451	15 Spot (15°)
W	3000	2794 - 2134	3431 - 2620	30 Flood (34°)
N	4000	2990 - 2283	3431 - 2621	60 W.Flood (56°)

Électronique 18W

99106	99115	99344
ON/OFF 1 art. p 103 x 158 x h 27	0/1-10V 1 art. p 210 x 148 x h 28	DALI PUSH 1 art. p 210 x 148 x h 28

Électronique 25W

99112	83066	99330
ON/OFF 1 art. p 103 x 158 x h 27	0/1-10V DALI PUSH 1 art. p 124 x 167 x h 22	DALI PUSH 1 art. p 210 x 148 x h 28

DW **NEW** 15 W DC 700 mA

Dynamic White	
White	84143
Black	84144
Grey	84145
Gold	84146

	Cct	Optic
D	2700K - 5700K Dynamic White	15 Spot - 30 Flood - 45 W.Flood -

Électronique

83159	99333	DMX	Driver CV
DALI DT8 1 - 2 art. p 270 x 1490 x h 225	Dimmer DMX 1 - 2 art.	Controllers Pag 952 - 953	CV 48V Pag 941

RTG 93422W30 / 93442W60

DW **NEW** 25 W DC 700 mA

Dynamic White	
White	84147
Black	84148
Grey	84149
Gold	84150

	Cct	Optic
D	2700K - 5700K Dynamic White	15 Spot - 30 Flood - 45 W.Flood -

Électronique

83159	99333	DMX	Driver CV
DALI DT8 1 art. p 270 x 1490 x h 225	Dimmer DMX 1 - 2 art.	Controllers Pag 952 - 953	CV 48V Pag 941

Loro_Q | Downlight | arrayLED 8 W DC 220 mA

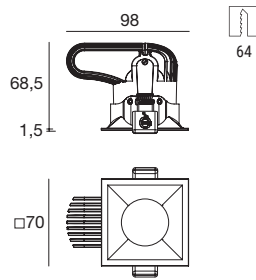

	CRI 92	CRI 92 HC	CRI 80	CRI 80 HC
White	97940	80823	97699	80819
Black	97941	80824	97700	80820
Grey	97944	80825	97701	80821
Gold	97945	80826	97702	80822

	Cct	lm S - D CRI 92	lm S - D CRI 80	Optic
M	2700	883 - 652	1088 - 867	15 Spot (15°)
W	3000	943 - 699	1088 - 928	30 Flood (34°)
N	4000	1016 - 753	1173 - 928	60 W.Flood (55°)
				33* W.Flood -

Électronique

99198	99732	99730
ON/OFF 1 art. p 134 x 137 x h 31	0/1-10V 1 art. p 134 x 137 x h 31	DALI PUSH 1 art. p 134 x 137 x h 31

RTG 97699W30 / 97699W60

* Filtre esthétique



Loro_Q avec filtre esthétique (33), disponible seulement pour les codes sans Honeycomb

Loro_Q | Downlight | arrayLED 13 W DC 350 mA

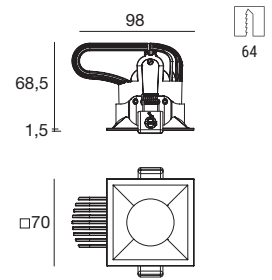

	CRI 92	CRI 92 HC	CRI 80	CRI 80 HC
White	91753	80831	91208	80827
Black	91754	80832	91209	80828
Grey	91755	80833	91210	80829
Gold	91756	80834	91211	80830

	Cct	lm S - D CRI 92	lm S - D CRI 80	Optic
M	2700	1399 - 813	1724 - 1081	15 Spot (8°)
W	3000	1496 - 871	1724 - 1156	30 Flood (18°)
N	4000	1610 - 938	1854 - 1156	60 W.Flood (54°)
				33* W.Flood -

Électronique

99260	99262	99721
ON/OFF 1 art. p 134 x 137 x h 31	0/1-10V 1 art. p 210 x 148 x h 25	DALI PUSH 1 art. p 210 x 148 x h 25

DW NEW 15 W DC 700 mA

	Dynamic White	HC Dynamic White
White	84127	84131
Black	84128	84132
Grey	84129	84133
Gold	84130	84134

	Cct	Optic
D	2700K - 5700K	Dynamic White
		15 Spot -
		30 Flood -
		45 W.Flood -

Électronique

83159	99333	DMX	Driver CV
DALI DT8 1 - 2 art. p 270 x 1490 x h 225	Dimmer DMX 1 - 2 art.	Controllers Pag 952 - 953	CV 48V Pag 941

RTG 91208W30 / 91208W60

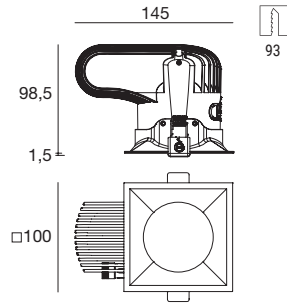

	CRI 92	CRI 92 HC	CRI 80	CRI 80 HC
White	80660	80839	80658	80835
Black	80661	80840	80659	80836
Grey	80690	80841	80688	80837
Gold	80691	80842	80689	80838

	Cct	18W Im S - D CRI 92	18W Im S - D CRI 80	Optic
M	2700	1901 - On req.	2349 - On req.	15 Spot (15°)
W	3000	2044 - On req.	2510 - On req.	30 Flood (34°)
N	4000	2188 - On req.	2510 - On req.	60 W.Flood (56°)

	Cct	25W Im S - D CRI 92	25W Im S - D CRI 80	Optic
M	2700	2598 - 1985	3210 - 2451	15 Spot (15°)
W	3000	2794 - 2134	3431 - 2621	30 Flood (34°)
N	4000	2990 - 2283	3431 - 2620	60 W.Flood (56°)

Électronique 18W

99106	99115	99344
ON/OFF 1 art. p 103 x 158 x h 27	0/1-10V 1 art. p 210 x 148 x h 28	DALI PUSH 1 art. p 210 x 148 x h 28

Électronique 25W

99112	83066	99330
ON/OFF 1 art. p 103 x 158 x h 27	0/1-10V DALI PUSH 1 art. p 124 x 167 x h 22	DALI PUSH 1 art. p 210 x 148 x h 28

DW **NEW** 25 W DC 700 mA

	Dynamic White	HC Dynamic White	Optic
White	84135	84139	15 Spot -
Black	84136	84140	30 Flood -
Grey	84137	84141	45 W.Flood -
Gold	84138	84142	
D	2700K - 5700K	Dynamic White	

Électronique

83159	99333	DMX	Driver CV
DALI DT8 1 art. p 270 x 1490 x h 225	Dimmer DMX 1 - 2 art.	Controllers Pag 952 - 953	CV 48V Pag 941

Loro_QJ | Downlight | arrayLED 8 W DC 220 mA

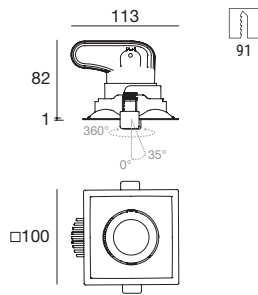

	CRI 92	CRI 92 HC	CRI 80	CRI 80 HC
White	80346	80887	80350	80883
Black	80347	80888	80351	80884
Grey	80348	80889	80352	80885
Gold	80349	80890	80353	80886

	Cct	lm S - D CRI 92	lm S - D CRI 80	Optic
M	2700	883 - 637	1088 - 785	15 Spot (17°)
W	3000	943 - 682	1088 - 785	30 Flood (34°)
N	4000	1016 - 734	1173 - 847	60 W.Flood (44°)
				33* W.Flood -

Électronique

99198	99732	99730
ON/OFF 1 art. p 134 x 137 x h 31	0/1-10V 1 art. p 134 x 137 x h 31	DALI PUSH 1 art. p 134 x 137 x h 31

* Filtre esthétique



Loro_QJ avec filtre esthétique (33), disponible seulement pour les codes sans Honeycomb

Loro_QJ | Downlight | arrayLED 13 W DC 350 mA

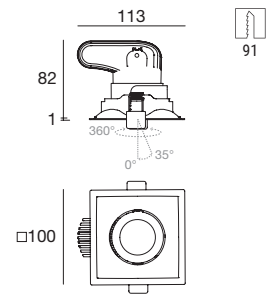

	CRI 92	CRI 92 HC	CRI 80	CRI 80 HC
White	80354	80895	80358	80891
Black	80355	80896	80359	80892
Grey	80356	80897	80360	80893
Gold	80357	80898	80361	80894

	Cct	lm S - D CRI 92	lm S - D CRI 80	Optic
M	2700	1399 - 1182	1724 - 1457	15 Spot (18°)
W	3000	1496 - 1265	1724 - 1457	30 Flood (23°)
N	4000	1610 - 1360	1854 - 1566	60 W.Flood (47°)
				33* W.Flood -

Électronique

99260	99262	99721
ON/OFF 1 art. p 134 x 137 x h 31	0/1-10V 1 art. p 210 x 148 x h 25	DALI PUSH 1 art. p 210 x 148 x h 25

DW **NEW** 15 W DC 700 mA

Dynamic White	
White	84151
Black	84152
Grey	84153
Gold	84154

	Cct	Optic
D	2700K - 5700K Dynamic White	15 Spot -
		30 Flood -
		45 W.Flood -

Électronique

83159	99333	DMX	Driver CV
DALI DT8 1 - 2 art. p 270 x 1490 x h 225	Dimmer DMX 1 - 2 art.	Controllers Pag 952 - 953	CV 48V Pag 941

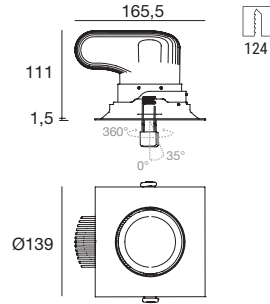

	CRI 92	CRI 92 HC	CRI 80	CRI 80 HC
White	80362	80903	80366	80899
Black	80363	80904	80367	80900
Grey	80364	80905	80368	80901
Gold	80365	80906	80369	80902

	Cct	18W Im S - D CRI 92	18W Im S - D CRI 80	Optic
M	2700	1901 - On req.	2349 - On req.	15 Spot (15°)
W	3000	2044 - On req.	2510 - On req.	30 Flood (34°)
N	4000	2188 - On req.	2510 - On req.	60 W.Flood (56°)

	Cct	25W Im S - D CRI 92	25W Im S - D CRI 80	Optic
M	2700	2598 - 1985	3210 - 2451	15 Spot (15°)
W	3000	2794 - 2134	3431 - 2620	30 Flood (34°)
N	4000	2990 - 2283	3431 - 2621	60 W.Flood (56°)

Électronique 18W

99106	99115	99344
ON/OFF 1 art. p 103 x l 158 x h 27	0/1-10V 1 art. p 210 x l 148 x h 28	DALI PUSH 1 art. p 210 x l 148 x h 28

Électronique 25W

99112	83066	99330
ON/OFF 1 art. p 103 x l 158 x h 27	0/1-10V DALI PUSH 1 art. p 124 x l 167 x h 22	DALI PUSH 1 art. p 210 x l 148 x h 28

DW NEW 25 W DC 700 mA

Dynamic White	
White	84155
Black	84156
Grey	84157
Gold	84158

			Optic
D	2700K - 5700K	Dynamic White	15 Spot -
			30 Flood -
			45 W.Flood -

Électronique

83159	99333	DMX	Driver CV
DALI DT8 1 art. p 270 x l 1490 x h 225	Dimmer DMX 1 - 2 art.	Controllers Pag 952 - 953	CV 48V Pag 941



giotto

Matériaux

Corps en aluminium





Unique en son genre

Grâce à la source de 9 mm et à la surprenante diffusion contrôlée disponible en trois variantes optiques (10°, 30°, 60°), Giotto constitue une solution innovante dans le domaine de l'éclairage et inégalée pour ce qui est le rapport entre le faible diamètre du trou de sortie du faisceau et l'efficacité lumineuse particulièrement élevé.



Échelle 1:1

9 mm

Technologie Cross Optics™

Cette technologie brevetée exploite le positionnement de deux lentilles optiques convexes placées l'une en face de l'autre : la première récupère la lumière à la surface de la seconde, en la canalisant dans un petit point pour une définition sans imperfection ; la seconde lentille rouvre le faisceau désormais privé de la composante secondaire en créant un cercle de lumière clair et net sur la surface illuminée.

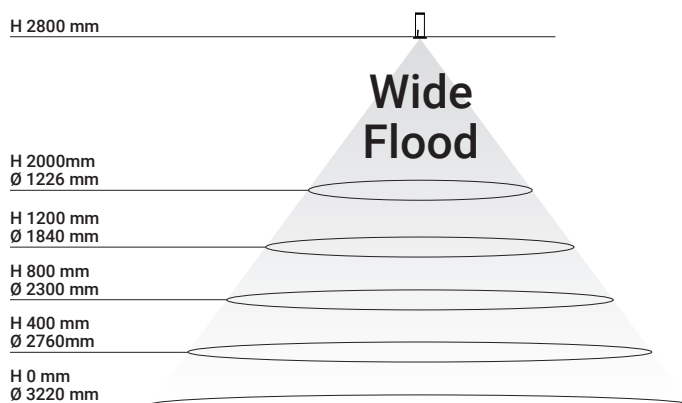
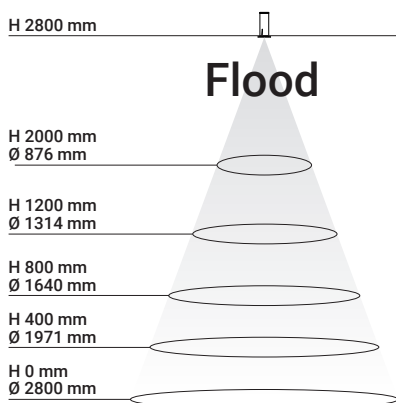

Giotto RF

La gamme Giotto s'élargit et accueille la nouvelle version trimless : Giotto_RF s'adapte à chaque plafond et disparaît intégralement, grâce à son corps blanc à fines rayures qui peut être peint. Le boîtier d'encastrement permet une installation à vis facile et un retrait tout aussi simple de l'article, qui peut être remplacé par un autre de la famille Giotto.

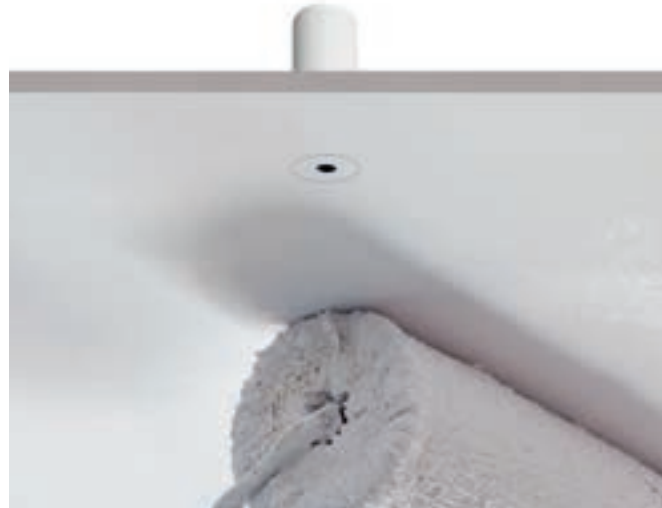

Giotto_R | Downlight | powerLED 4 W DC 350 mA

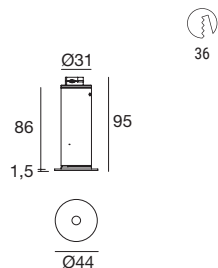

	CRI 92	CRI 80
White	84199	84201
Black	84200	84202

	Cct	lm S - D CRI 92	lm S - D CRI 80	Optic
M	2700	395 - 80	490 - 99	10 Spot -
W	3000	423 - 85	490 - 99	30 Flood (24°)
N	4000	456 - 93	529 - 107	60 W.Flood (55°)

Électronique

89145	99375	99708	99711	+ driver 24V DC 99374 75W 99331 150W
ON/OFF 1 art. p 138 x l 22 x h 21	ON/OFF 2-3 art. p 138 x l 22 x h 21	0/1-10V converter 1 art. p 138 x l 22 x h 21	DALI converter 1 art. p 138 x l 22 x h 21	



Giotto_R | Downlight | powerLED 6 W DC 500 mA

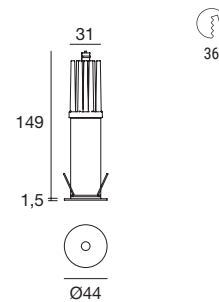

	CRI 92	CRI 80
White	84203	84205
Black	84204	84206

	Cct	lm S - D CRI 92	lm S - D CRI 80	Optic
M	2700	532 - 106	659 - 130	10 Spot -
W	3000	569 - 113	659 - 130	30 Flood (24°)
N	4000	614 - 121	711 - 142	60 W.Flood (55°)

Électronique

99377	99106	99714	99715
ON/OFF 1 art. p 138 x l 22 x h 21	ON/OFF 2-3 art. p 103 x l 58 x h 27	0/1-10V 1 art. p 138 x l 22 x h 21	DALI 1 art. p 138 x l 22 x h 21



RTG 84203W30

Giotto_P | Pendant | 198-264 V AC | powerLED 7,5 W DC - 9 W AC

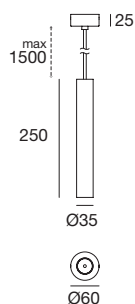

	CRI 92	CRI 80
White	81477	81479
Black	81478	81480

	Cct	lm S - D CRI 92	lm S - D CRI 80	Optic
M	2700	614 - 117	760 - 145	10 Spot -
W	3000	657 - 125	760 - 145	30 Flood (23°)
N	4000	709 - 135	821 - 157	60 W.Flood (58°)

Giotto_RF | Downlight | powerLED 4 W DC 350 mA

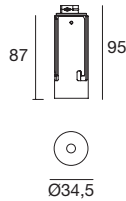

	CRI 92	CRI 80
White	82075	82076

	Cct	lm S - D CRI 92	lm S - D CRI 80	Optic
M	2700	395 - On req	490 - On req	10 Spot (24°)
W	3000	423 - On req	490 - On req	30 Flood (24°)
N	4000	457 - On req	529 - On req	60 W.Flood (55°)

Électronique

89145	99375	99708	99711	+ driver 24V DC 99374 75W 99331 150W
ON/OFF 1 art. p 138 x l 22 x h 21	ON/OFF 2-3 art. p 138 x l 22 x h 21	0/1-10V converter 1 art. p 138 x l 22 x h 21	DALI converter 1 art. p 138 x l 22 x h 21	



Boîtier d'encastrement

98502 H. 28 Ø 43 mm

Giotto_RF | Downlight | powerLED 6 W DC 500 mA

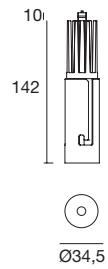

	CRI 92	CRI 80
White	82077	82078

	Cct	lm S - D CRI 92	lm S - D CRI 80	Optic
M	2700	532 - On req	659 - On req	10 Spot (24°)
W	3000	569 - On req	659 - On req	30 Flood (24°)
N	4000	614 - On req	712 - On req	60 W.Flood (55°)

Électronique

99377	99106	99714	99715
ON/OFF 1 art. p 138 x l 22 x h 21	ON/OFF 2-3 art. p 103 x l 58 x h 27	0/1-10V 1 art. p 138 x l 22 x h 21	DALI 1 art. p 138 x l 22 x h 21



Boîtier d'encastrement

98502 H. 28 Ø 43 mm

Boîtier d'encastrement



description

98502

Boîtier d'encastrement pour installation affleurante

suitable for: Giotto_RF 4W / Giotto_RF 6W



40



cob40

Matériaux
Corps en aluminium

Encombrement minime

Cob40 est un spot encastrable aux dimensions réduites d'une grande efficacité. Disponibles dans deux versions, fixe ou basculante et trois puissances différentes 6,5 W, 15, et 18 watts. Grâce aux nouveaux accessoires, la couleur de l'anneau interne de Cob40 peut être changé pour s'adapter et s'harmoniser avec le milieu environnant.

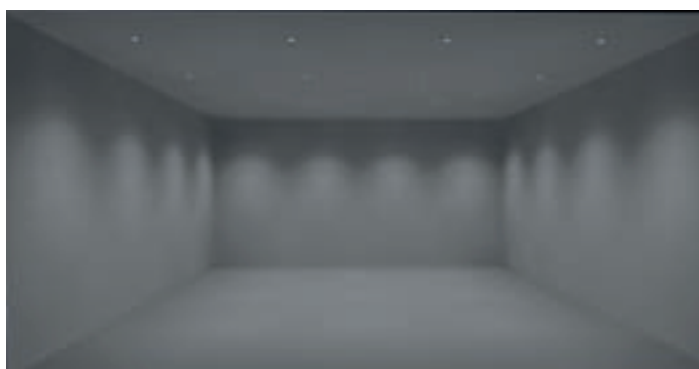
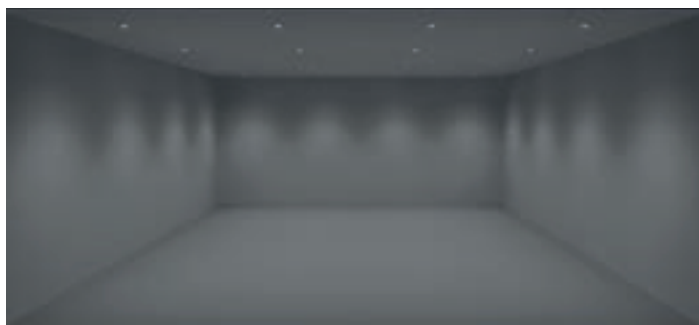

Cob40_R | Downlight | arrayLED 6,5 W DC 700 mA

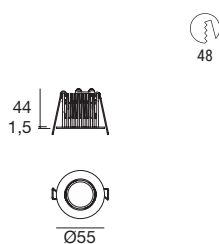

CRI 80

White	80244
Black	80245

Cct	lm S - D CRI 80	Optic
M 2700	770 - 689	15 Spot (17°)
W 3000	770 - 689	30 Flood (24°)
N 4000	831 - 744	60 W.Flood (54°)

Électronique

99735	99147	99733	99731	99345
ON/OFF 1 art. p 134 x l 37 x h 31	ON/OFF 2 - 3 art. p 103 x l 58 x h 27	0/1-10V 1 art. p 134 x l 37 x h 31	DALI PUSH 1 art. p 134 x l 37 x h 31	DALI PUSH 1 - 3 art. p 210 x l 48 x h 25

Accessoires Pag. 87

99888 Accessoires	99890 Accessoires
99889 Accessoires	99899 Accessoires
89373 Boîtier d'encastrement	89374 Boîtier d'encastrement

Cob40_R | Downlight | arrayLED 18 W DC 500 mA

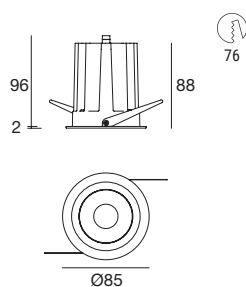

CRI 92	CRI 80
White 82473	82475
Black 82474	82476

Cct	lm S - D CRI 92	lm S - D CRI 80	Optic
M 2700	1939 - On req	2304 - On req	15 Spot -
W 3000	2030 - On req	2401 - On req	30 Flood -
N 4000	2182 - On req	2535 - On req	60 W.Flood -

Électronique

99106	99115	99344
ON/OFF 1 art. p 103 x l 58 x h 27	0/1-10V 1 art. p 210 x l 48 x h 28	DALI PUSH 1 art. p 210 x l 48 x h 28

Accessoires Pag. 87

99901 Accessoires	99903 Accessoires
99902 Accessoires	99904 Accessoires
89373 Boîtier d'encastrement	89374 Boîtier d'encastrement

Cob40_R | Downlight | arrayLED 15 W DC 400 mA

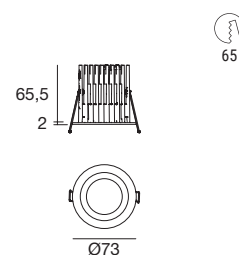
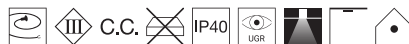

CRI 80

White	81351
Black	81352

Cct	lm S - D CRI 80	Optic
M 2700	1932 - 1522	15 Spot (22°)
W 3000	1932 - 1522	30 Flood (31°)
N 4000	2078 - 1637	60 W.Flood (58°)

Électronique

99734	99732	99730
ON/OFF 1 art. p 134 x l 37 x h 31	0/1-10V 1 art. p 134 x l 37 x h 31	DALI PUSH 1 art. p 134 x l 37 x h 31

Accessoires Pag. 87

99891 Accessoires	99893 Accessoires
99892 Accessoires	99900 Accessoires
89373 Boîtier d'encastrement	89374 Boîtier d'encastrement

Cob40_RJ | Downlight | arrayLED 6,5 W DC 700 mA

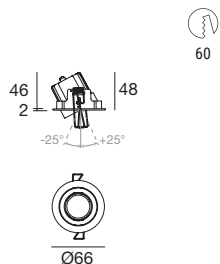

CRI 80

White	80109
Black	80110

	Cct	lm S - D CRI 80	Optic
M	2700	770 - 689	15 Spot (17°)
W	3000	770 - 689	30 Flood (24°)
N	4000	831 - 744	60 W.Flood (54°)

Électronique

99735	99147	99733	99731	99345
ON/OFF 1 art. p 134 x l 137 x h 31	ON/OFF 2 - 3 art. p 103 x l 58 x h 27	0/1-10V 1 art. p 134 x l 137 x h 31	DALI PUSH 1 art. p 134 x l 137 x h 31	DALI PUSH 1 - 3 art. p 210 x l 148 x h 25

Accessoires

99888 Accessoires	99890 Accessoires
99889 Accessoires	99899 Accessoires
89373 Boîtier d'encastrement	89374 Boîtier d'encastrement

Cob40_RJ | Downlight | arrayLED 18 W DC 500 mA

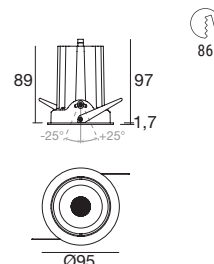

	CRI 92	CRI 80
White	82477	82479
Black	82478	82480

	Cct	lm S - D CRI 92	lm S - D CRI 80	Optic
M	2700	1939 - On req	2304 - On req	15 Spot -
W	3000	2030 - On req	2401 - On req	30 Flood -
N	4000	2182 - On req	2535 - On req	60 W.Flood -

Électronique

99106	99115	99344
ON/OFF 1 art. p 103 x l 58 x h 27	0/1-10V 1 art. p 210 x l 148 x h 28	DALI PUSH 1 art. p 210 x l 148 x h 28

Accessoires

99901 Accessoires	99903 Accessoires
99902 Accessoires	99904 Accessoires

Accessoires

	description	type
	99888	White
	99889 Accessoires	Gold
	99890	Copper
	99899	Chrome

suitable for: Cob40_R 6,5W / Cob40_RJ 6,5W

	description	type
	99891	White
	99892 Accessoires	Gold
	99893	Copper
	99900	Chrome

suitable for: Cob40_R 15W

	description	type
	99901	White
	99902 Accessoires	Gold
	99903	Copper
	99904	Chrome

suitable for: Cob40_R 18W / Cob40_RJ 18W

RTG 99888 / 99889 / 99890 / 99899

RTG 99901 / 99902 / 99903 / 99904

	description	type
	89374 Boîtier d'encastrement	

suitable for: Cob40_R 6,5W / Cob40_R 15W
Cob40_R 18W / Cob40_RJ 6,5W

	description	type
	89373 Boîtier d'encastrement	

suitable for: Cob40_R 6,5W / Cob40_R 15W
Cob40_R 18W / Cob40_RJ 6,5W



cob44

Matériaux

Corps en aluminium

Collerette en polycarbonate



Cob44_R | Downlight | arrayLED 6,5 W DC 700 mA

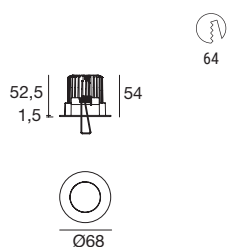

CRI 80

- White **96801**
- Black **96802**

	Cct	lm S - D CRI 80	Optic
M	2700	770 - 635	15 Spot (15°)
W	3000	770 - 635	30 Flood (26°)
N	4000	831 - 685	60 W.Flood (52°)

Électronique

99735	99147	99733	99731	99345
ON/OFF 1 art. p 134 x 137 x h 31	ON/OFF 2 - 3 art. p 103 x 158 x h 27	0/1-10V 1 art. p 134 x 137 x h 31	DALI PUSH 1 art. p 134 x 137 x h 31	DALI PUSH 1 - 3 art. p 210 x 148 x h 25

Cob44_R | Downlight | arrayLED 11 W DC 300 mA

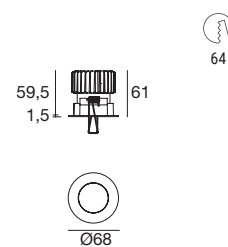

CRI 80

- White **93832**
- Black **93833**

	Cct	lm S - D CRI 80	Optic
M	2700	1399 - 1147	15 Spot (17°)
W	3000	1399 - 1147	30 Flood (22°)
N	4000	1507 - 1235	60 W.Flood (51°)

Électronique

99734	99732	99730
ON/OFF 1 art. p 88 x 138 x h 23	0/1-10V 1 art. p 134 x 137 x h 31	DALI_PUSH 1 art. p 134 x 137 x h 31

Cob44_RJ | Downlight | arrayLED 6,5 W DC 700 mA

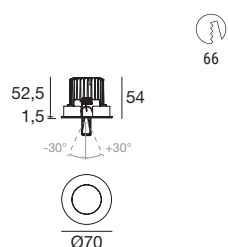

CRI 80

- White **96803**
- Black **96804**

	Cct	lm S - D CRI 80	Optic
M	2700	770 - 635	15 Spot (15°)
W	3000	770 - 635	30 Flood (26°)
N	4000	831 - 685	60 W.Flood (52°)

Électronique

99735	99147	99733	99731	99345
ON/OFF 1 art. p 134 x 137 x h 31	ON/OFF 2 - 3 art. p 103 x 158 x h 27	0/1-10V 1 art. p 134 x 137 x h 31	DALI PUSH 1 art. p 134 x 137 x h 31	DALI PUSH 1 - 3 art. p 210 x 148 x h 25

Cob44_RJ | Downlight | arrayLED 11 W DC 300 mA

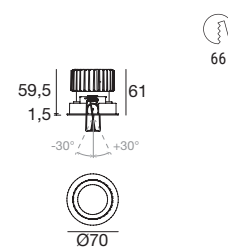

CRI 80

- White **93834**
- Black **93835**

	Cct	lm S - D CRI 80	Optic
M	2700	1399 - 1147	15 Spot (17°)
W	3000	1399 - 1147	30 Flood (22°)
N	4000	1507 - 1235	60 W.Flood (51°)

Électronique

99734	99732	99730
ON/OFF 1 art. p 88 x 138 x h 23	0/1-10V 1 art. p 134 x 137 x h 31	DALI_PUSH 1 art. p 134 x 137 x h 31

Cob44_Q | Downlight | arrayLED 6,5 W DC 700 mA

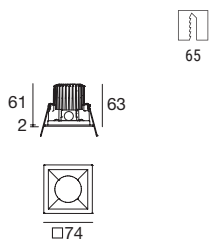

CRI 80

White **93354**
Black **93355**

	Cct	lm S - D CRI 80	Optic
M	2700	770 - 635	15 Spot (15°)
W	3000	770 - 635	30 Flood (26°)
N	4000	831 - 685	60 W.Flood (52°)

Électronique

99735	99147	99733	99731	99345
ON/OFF 1 art. p 134 x 137 x h 31	ON/OFF 2 - 3 art. p 103 x 158 x h 27	0/1-10V 1 art. p 134 x 137 x h 31	DALI PUSH 1 art. p 134 x 137 x h 31	DALI PUSH 1 - 3 art. p 210 x 148 x h 25

Cob44_Q | Downlight | arrayLED 11 W DC 300 mA

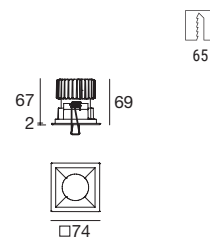

CRI 80

White **93836**
Black **93839**

	Cct	lm S - D CRI 80	Optic
M	2700	1399 - 1147	15 Spot (13°)
W	3000	1399 - 1147	30 Flood (27°)
N	4000	1507 - 1235	60 W.Flood (54°)

Électronique

99734	99732	99730
ON/OFF 1 art. p 88 x 138 x h 23	0/1-10V 1 art. p 134 x 137 x h 31	DALI_PUSH 1 art. p 134 x 137 x h 31

Cob44_QJ | Downlight | arrayLED 6,5 W DC 700 mA

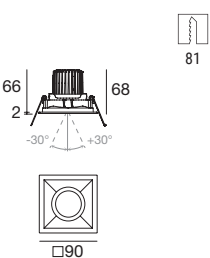

CRI 80

White **93844**
Black **93847**

	Cct	lm S - D CRI 80	Optic
M	2700	770 - 635	15 Spot (15°)
W	3000	770 - 635	30 Flood (26°)
N	4000	831 - 685	60 W.Flood (52°)

Électronique

99735	99147	99733	99731	99345
ON/OFF 1 art. p 134 x 137 x h 31	ON/OFF 2 - 3 art. p 103 x 158 x h 27	0/1-10V 1 art. p 134 x 137 x h 31	DALI PUSH 1 art. p 134 x 137 x h 31	DALI PUSH 1 - 3 art. p 210 x 148 x h 25

Cob44_QJ | Downlight | arrayLED 11 W DC 300 mA

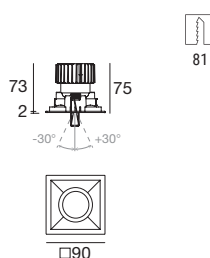

CRI 80

White **93840**
Black **93843**

	Cct	lm S - D CRI 80	Optic
M	2700	1399 - 1147	15 Spot (17°)
W	3000	1399 - 1147	30 Flood (22°)
N	4000	1507 - 1235	60 W.Flood (51°)

Électronique

99734	99732	99730
ON/OFF 1 art. p 88 x 138 x h 23	0/1-10V 1 art. p 134 x 137 x h 31	DALI_PUSH 1 art. p 134 x 137 x h 31



cob20

Matériaux

Corps en aluminium

Collerette en ABS



cob20 range



	_R Round	_RX Round	_Q Square
15W	Ø 147 mm - Ø 197 mm Ø 227 mm - Ø 250 mm	-	□ 140 mm - □ 175 mm □ 205 mm
25W	Ø 147 mm - Ø 197 mm Ø 227 mm - Ø 250 mm	Ø 147 mm	□ 140 mm - □ 175 mm □ 205 mm
30W	Ø 197 mm - Ø 227 mm Ø 250 mm	Ø 197 mm	□ 175 mm - □ 205 mm
35W	Ø 227 mm - Ø 250 mm	Ø 227 mm	□ 205 mm
45W	-	Ø 252 mm	-
Finish	White	White	White
CRI 80	2700K - 3000K - 4000K	2700K - 3000K - 4000K	2700K - 3000K - 4000K
Optics	Wide Flood - Extra Wide Flood	Spot - Flood - Wide Flood	Extra Wide Flood
Driver	On/Off - 1/10 V - DALI	On/Off - 1/10 V - DALI	On/Off - 1/10 V - DALI
	129 mm - 180 mm 210 mm - 236 mm	129 mm - 180 mm 210 mm - 236 mm	□ 122 mm - □ 157 mm □ 188 mm

Longue durée de vie

Luminaires dotés d'un système de dissipation passive à efficacité élevée avec profilés extrudés en alliage d'aluminium 6060. Les diodes utilisées peuvent facilement atteindre des températures élevées qui affectent leurs performances et leur durée de vie : grâce à des lamelles en éventail, les downlights Cob20 bénéficient d'une surface maximale pour refroidir efficacement la source LED, assurant ainsi l'équilibre entre performances élevées et longue durée de vie.

50.3° C



23.3° C

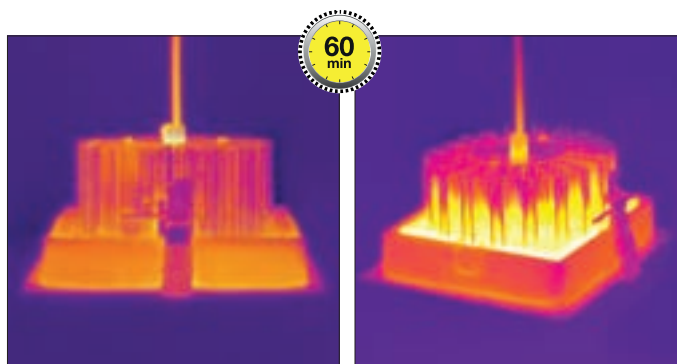

Indice UGR

L'indice UGR (Unified Glare Rating) évalue la présence d'un éblouissement de type gênant, c'est-à-dire inconfortable pour l'œil en raison d'une luminance excessive dans le champ visuel. Les versions COB20_RX garantissent un indice UGR inférieur à 19 correspondant à la valeur seuil pour un bon éclairage des bureaux selon les prescriptions minimales de santé et de sécurité relatives au travail sur équipement à écran de visualisation (norme UNI-EN 12464-1).

Montage facile et sûr

Les laboratoires techniques i-LèD ont développé des ressorts innovants avec technologie « smart spring » pour les versions traditionnelles et celles en technologie torsionnelle avec crochet profilé. Ils permettent d'installer les downlights plus facilement et plus rapidement, sans endommager la plaque de plâtre ou la surface d'installation. Ils garantissent également la sûreté de la fixation, empêchant les chutes accidentelles, y compris dans des environnements soumis à de fortes sollicitations mécaniques (p. ex. les stations de métro). Les downlights de la série COB peuvent également être installés et allumés sans réflecteur, qui peut être monté dans un second temps, à la fin des travaux, pour assurer une propreté parfaite. Les downlights i-LèD peuvent être installés sur des faux plafonds présentant une épaisseur réduite allant d'un minimum de 10 mm à un maximum de 30 mm.

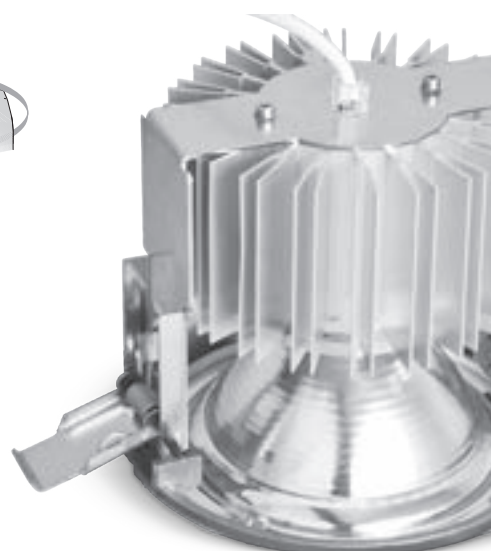

Plus de lumière, moins de consommation

Les downlights COB sont conçus pour remplacer de manière simple et rapide les luminaires conventionnels, en améliorant l'efficacité énergétique du système d'éclairage. Exemple de remplacement de downlights fluorescents avec le même nombre de luminaires i-LèD.

- Réduction de la consommation de 31 %
- Même nombre d'appareils
- Meilleur niveau d'éclairage (+34 %)
- Durée de vie plus longue

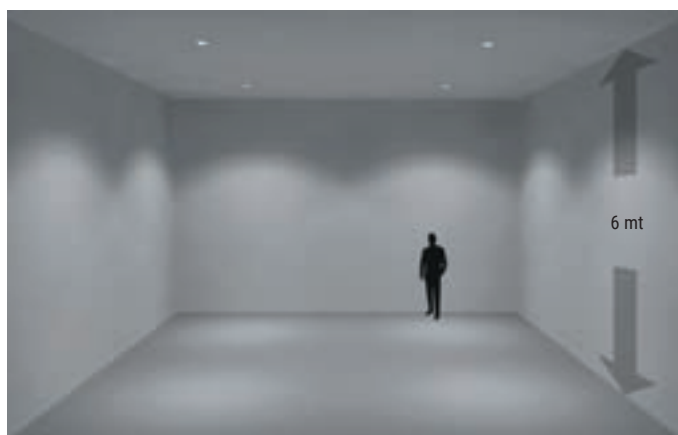

Cob20_R | Downlight | arrayLED

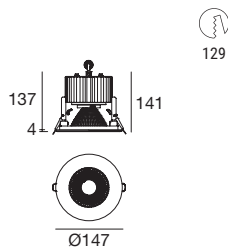

CRI 80

White **96809**

	Cct	lm S - D CRI 80 15W	Optic
M	2700	1953 - On req	40 W.Flood (54°)
W	3000	2088 - On req	90 E.W.Flood(61°)
N	4000	2088 - On req	

Électronique 15W 400mA

99740	99739	99738
ON/OFF 1 art. p 134 x l 137 x h 31	0/1-10V 1 art. p 134 x l 137 x h 31	DALI PUSH 1 art. p 134 x l 137 x h 31

	Cct	lm S - D CRI 80 25W	Optic
M	2700	3210 - 2421	40 W.Flood (54°)
W	3000	3431 - 2593	90 E.W.Flood(61°)
N	4000	3431 - 2786	

Électronique 25W DC 700mA

99112	83066	99330
ON/OFF 1 art. p 103 x l 158 x h 27	0/1-10V DALI PUSH 1 art. p 124 x l 167 x h 22	DALI PUSH 1 art. p 210 x l 148 x h 28

Cob20_R | Downlight | arrayLED

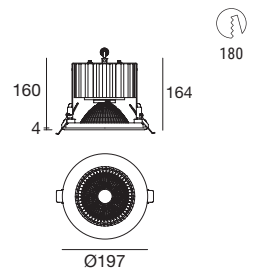

CRI 80

White **96813**

	Cct	lm S - D CRI 80 15W	Optic
M	2700	2082 - On req	40 W.Flood (51°)
W	3000	2227 - On req	90 E.W.Flood(85°)
N	4000	2393 - On req	

Électronique 15W 400mA

99740	99739	99738
ON/OFF 1 art. p 134 x l 137 x h 31	0/1-10V 1 art. p 134 x l 137 x h 31	DALI PUSH 1 art. p 134 x l 137 x h 31

	Cct	lm S - D CRI 80 25W	Optic
M	2700	3400 - On req	40 W.Flood (51°)
W	3000	3637 - On req	90 E.W.Flood(85°)
N	4000	3909 - On req	

Électronique 25W DC 700mA

99112	83066	99330
ON/OFF 1 art. p 103 x l 158 x h 27	0/1-10V DALI PUSH 1 art. p 124 x l 167 x h 22	DALI PUSH 1 art. p 210 x l 148 x h 28

	Cct	lm S - D CRI 80 30W	Optic
M	2700	3991 - 3065	40 W.Flood (51°)
W	3000	4270 - 3283	90 E.W.Flood(85°)
N	4000	4588 - 3527	

Électronique 30W DC 840mA

99093	83066	99330
ON/OFF 1 art. p 103 x l 158 x h 27	0/1-10V DALI PUSH 1 art. p 124 x l 167 x h 22	DALI PUSH 1 art. p 210 x l 148 x h 28

Cob20_R | Downlight | arrayLED

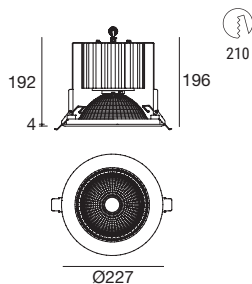

CRI 80

White **96819**

	Cct	lm S - D CRI 80 15W	Optic
M	2700	2082 - On req	40 W.Flood (54°)
W	3000	2227 - On req	90 E.W.Flood(61°)
N	4000	2393 - On req	

Électronique 15W 400mA

99740	99739	99738
ON/OFF 1 art. p 134 x l 37 x h 31	0/1-10V 1 art. p 134 x l 37 x h 31	DALI PUSH 1 art. p 134 x l 37 x h 31

	Cct	lm S - D CRI 80 25W	Optic
M	2700	3400 - On req	40 W.Flood (54°)
W	3000	3637 - On req	90 E.W.Flood(61°)
N	4000	3909 - On req	

Électronique 25W DC 700mA

99112	83066	99330
ON/OFF 1 art. p 103 x l 58 x h 27	0/1-10V DALI PUSH 1 art. p 124 x l 67 x h 22	DALI PUSH 1 art. p 210 x l 48 x h 28

	Cct	lm S - D CRI 80 30W	Optic
M	2700	3991 - On req	40 W.Flood (54°)
W	3000	4270 - On req	90 E.W.Flood(61°)
N	4000	4588 - On req	

Électronique 30W DC 840mA

99093	83066	99330
ON/OFF 1 art. p 103 x l 58 x h 27	0/1-10V DALI PUSH 1 art. p 124 x l 67 x h 22	DALI PUSH 1 art. p 210 x l 48 x h 28

	Cct	lm S - D CRI 80 35W	Optic
M	2700	4363 - On req	40 W.Flood (54°)
W	3000	4667 - On req	90 E.W.Flood(61°)
N	4000	5016 - On req	

Électronique 35W DC 950mA

99146	83066	99330
ON/OFF 1 art. p 103 x l 58 x h 27	0/1-10V DALI PUSH 1 art. p 124 x l 67 x h 22	DALI PUSH 1 art. p 210 x l 48 x h 28

Cob20_R | Downlight | arrayLED

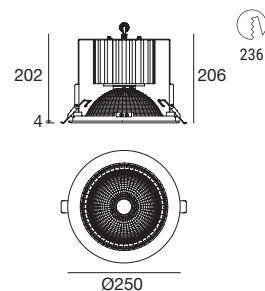

CRI 80

White **97130**

	Cct	lm S - D CRI 80 15W	Optic
M	2700	2082 - On req	40 W.Flood (54°)
W	3000	2227 - On req	90 E.W.Flood(61°)
N	4000	2393 - On req	

Électronique 15W 400mA

99740	99739	99738
ON/OFF 1 art. p 134 x l 37 x h 31	0/1-10V 1 art. p 134 x l 37 x h 31	DALI PUSH 1 art. p 134 x l 37 x h 31

	Cct	lm S - D CRI 80 25W	Optic
M	2700	3400 - On req	40 W.Flood (54°)
W	3000	3637 - On req	90 E.W.Flood(61°)
N	4000	3909 - On req	

Électronique 25W DC 700mA

99112	83066	99330
ON/OFF 1 art. p 103 x l 58 x h 27	0/1-10V DALI PUSH 1 art. p 124 x l 67 x h 22	DALI PUSH 1 art. p 210 x l 48 x h 28

	Cct	lm S - D CRI 80 30W	Optic
M	2700	3991 - On req	40 W.Flood (54°)
W	3000	4270 - On req	90 E.W.Flood(61°)
N	4000	4588 - On req	

Électronique 30W DC 840mA

99093	83066	99330
ON/OFF 1 art. p 103 x l 58 x h 27	0/1-10V DALI PUSH 1 art. p 124 x l 67 x h 22	DALI PUSH 1 art. p 210 x l 48 x h 28

	Cct	lm S - D CRI 80 35W	Optic
M	2700	4363 - On req	40 W.Flood (54°)
W	3000	4667 - On req	90 E.W.Flood(61°)
N	4000	5016 - On req	

Électronique 35W DC 950mA

99146	83066	99330
ON/OFF 1 art. p 103 x l 58 x h 27	0/1-10V DALI PUSH 1 art. p 124 x l 67 x h 22	DALI PUSH 1 art. p 210 x l 48 x h 28

Cob20_Q | Downlight | arrayLED

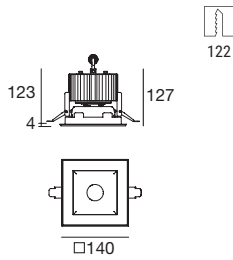

CRI 80

White **96827**

	Cct	lm S - D CRI 80 15W	Optic
M	2700	1953 - On req	90 E.W.Flood(106°)
W	3000	2088 - On req	
N	4000	2088 - On req	

Électronique 15W 400mA

99740	99739	99738
ON/OFF 1 art. p 134 x 137 x h 31	0/1-10V DALI PUSH 1 art. p 134 x 137 x h 31	DALI PUSH 1 art. p 134 x 137 x h 31

	Cct	lm S - D CRI 80 25W	Optic
M	2700	3210 - 1987	90 E.W.Flood(106°)
W	3000	3431 - 2128	
N	4000	3431 - 2287	

Électronique 25W DC 700mA

99112	83066	99330
ON/OFF 1 art. p 103 x 158 x h 27	0/1-10V DALI PUSH 1 art. p 124 x 167 x h 22	DALI PUSH 1 art. p 210 x 148 x h 28

Cob20_Q | Downlight | arrayLED

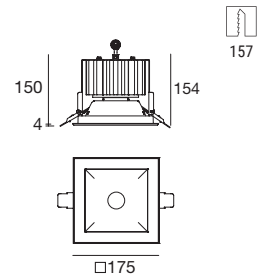

CRI 80

White **96831**

	Cct	lm S - D CRI 80 15W	Optic
M	2700	2082 - On req	90 E.W.Flood(93°)
W	3000	2227 - On req	
N	4000	2393 - On req	

Électronique 15W 400mA

99740	99739	99738
ON/OFF 1 art. p 134 x 137 x h 31	0/1-10V DALI PUSH 1 art. p 134 x 137 x h 31	DALI PUSH 1 art. p 134 x 137 x h 31

	Cct	lm S - D CRI 80 25W	Optic
M	2700	3400 - On req	90 E.W.Flood(93°)
W	3000	3637 - On req	
N	4000	3909 - On req	

Électronique 25W DC 700mA

99112	83066	99330
ON/OFF 1 art. p 103 x 158 x h 27	0/1-10V DALI PUSH 1 art. p 124 x 167 x h 22	DALI PUSH 1 art. p 210 x 148 x h 28

	Cct	lm S - D CRI 80 30W	Optic
M	2700	3991 - 2747	90 E.W.Flood(93°)
W	3000	4270 - 2942	
N	4000	4588 - 3161	

Électronique 30W DC 840mA

99093	83066	99330
ON/OFF 1 art. p 103 x 158 x h 27	0/1-10V DALI PUSH 1 art. p 124 x 167 x h 22	DALI PUSH 1 art. p 210 x 148 x h 28

97130W40

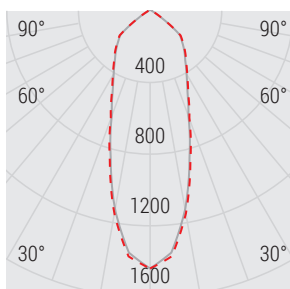

Courbe photométrique

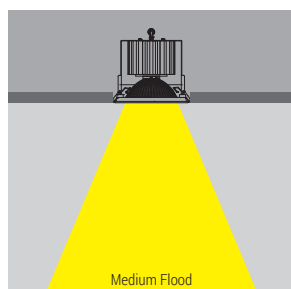

Faisceau lumineux

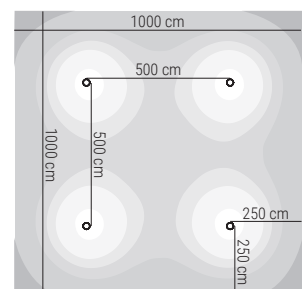
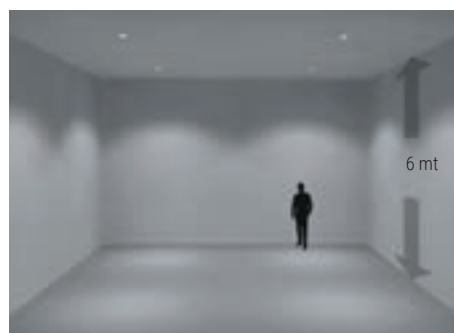

Planimétrie

Cob20_Q | Downlight | arrayLED

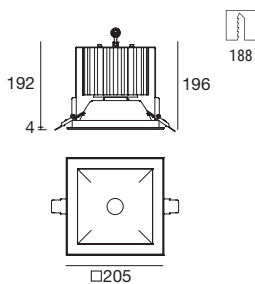
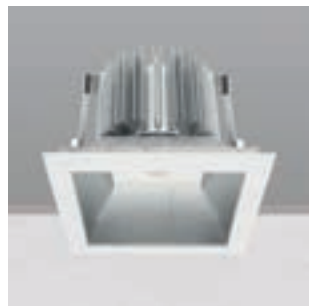

CRI 80

White **96837**

	Cct	lm S - D CRI 80 15W	Optic
M	2700	2082 - On req	90 E.W.Flood(87°)
W	3000	2227 - On req	
N	4000	2393 - On req	

Électronique 15W 400mA

99740	99739	99738
ON/OFF 1 art. p 134 x 137 x h 31	0/1-10V 1 art. p 134 x 137 x h 31	DALI PUSH 1 art. p 134 x 137 x h 31

	Cct	lm S - D CRI 80 25W	Optic
M	2700	3400 - On req	90 E.W.Flood(87°)
W	3000	3637 - On req	
N	4000	3909 - On req	

Électronique 25W DC 700mA

99112	83066	99330
ON/OFF 1 art. p 103 x 158 x h 27	0/1-10V DALI PUSH 1 art. p 124 x 167 x h 22	DALI PUSH 1 art. p 210 x 148 x h 28

	Cct	lm S - D CRI 80 30W	Optic
M	2700	3991 - On req	90 E.W.Flood(87°)
W	3000	4270 - On req	
N	4000	4588 - On req	

Électronique 30W DC 840mA

99093	83066	99330
ON/OFF 1 art. p 103 x 158 x h 27	0/1-10V DALI PUSH 1 art. p 124 x 167 x h 22	DALI PUSH 1 art. p 210 x 148 x h 28

	Cct	lm S - D CRI 80 35W	Optic
M	2700	4363 - On req	90 E.W.Flood(87°)
W	3000	4667 - On req	
N	4000	5016 - On req	

Électronique 35W DC 950mA

99146	83066	99330
ON/OFF 1 art. p 103 x 158 x h 27	0/1-10V DALI PUSH 1 art. p 124 x 167 x h 22	DALI PUSH 1 art. p 210 x 148 x h 28

Cob20_RX | comfort UGR<16 | Downlight | arrayLED 25 W DC 700 mA

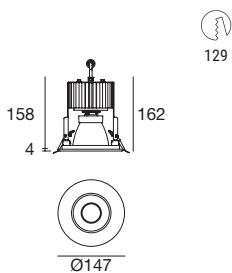

129

CRI 80

White 91398

	Cct	lm S - D CRI 80	Optic
M	2700	3580 - 2933	15 Spot (23°)
W	3000	3847 - 3153	30 Flood (33°)
N	4000	3847 - 3153	60 W.Flood (42°)

Électronique

99112	83066	99330
ON/OFF 1 art. p 103 x 158 x h 27	0/1-10V DALI PUSH 1 art. p 124 x 167 x h 22	DALI PUSH 1 art. p 210 x 148 x h 28

Cob20_RX | comfort UGR<16 | Downlight | arrayLED 30 W DC 840 mA

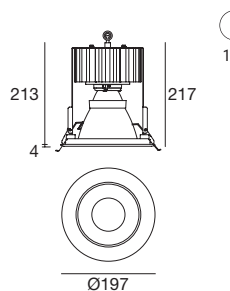

180

CRI 80

White 91402

	Cct	lm S - D CRI 80	Optic
M	2700	4220 - 3372	15 Spot (23°)
W	3000	4535 - 3625	30 Flood (33°)
N	4000	4535 - 3625	60 W.Flood (42°)

Électronique

99093	83066	99330
ON/OFF 1 art. p 103 x 158 x h 27	0/1-10V DALI PUSH 1 art. p 124 x 167 x h 22	DALI PUSH 1 art. p 210 x 148 x h 28

Cob20_RX | comfort UGR<16 | Downlight | arrayLED 35 W DC 950 mA

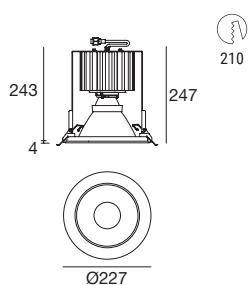

210

CRI 80

White 91410

	Cct	lm S - D CRI 80	Optic
M	2700	4811 - 4311	15 Spot (23°)
W	3000	4811 - 4632	30 Flood (33°)
N	4000	5173 - 4953	60 W.Flood (42°)

Électronique

99146	83066	99330
ON/OFF 1 art. p 103 x 158 x h 27	0/1-10V DALI PUSH 1 art. p 124 x 167 x h 22	DALI PUSH 1 art. p 210 x 148 x h 28

Cob20_RX | comfort UGR<16 | Downlight | arrayLED 45 W DC 1250 mA

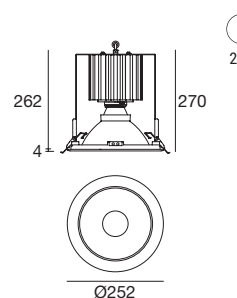

236

CRI 80

White 91414

	Cct	lm S - D CRI 80	Optic
M	2700	6002 - 4870	15 Spot (23°)
W	3000	6002 - 5233	30 Flood (33°)
N	4000	6452 - 5596	60 W.Flood (42°)

Électronique

83114	83066
ON/OFF 1 art. p 160 x 170 x h 36	0/1-10V DALI PUSH 1 art. p 124 x 167 x h 22





anton

Matériaux
Corps en aluminium

Anton_R | Downlight | powerLED 2 W DC 630 mA

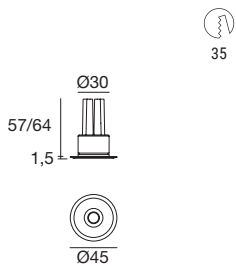
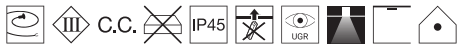

CRI 80

White 91896

Cct	lm S - D CRI 80	Optic
W 3000	233 - 142	08 N.Spot (8°)
N 4000	249 - 152	15 Spot (17°)
		30 Flood (22°)
		60 W.Flood (60°)
		12 E.W.Flood(110°)

Électronique

89147	99376	99105	99710	99713	+ driver 24V DC 99374 75W 99331 150W
ON/OFF 1 - 2 art. p 138 x l 22 x h 21	ON/OFF 3 - 6 art. p 138 x l 22 x h 21	ON/OFF 6 - 12 art. p 103 x l 58 x h 27	24V DC converter 0/1-10V 1 art. p 138 x l 22 x h 21	24V DC converter DALI 1 art. p 138 x l 22 x h 21	



Anton_R | Downlight | powerLED 6 W DC 630 mA

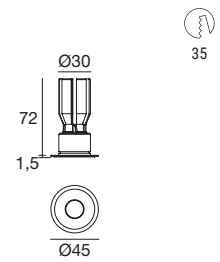

CRI 80

White 96634

Cct	lm S - D CRI 80	Optic
W 3000	699 - 454	15 Spot (17°)
N 4000	747 - 517	30 Flood (24°)
		60 W.Flood (57°)
		12 E.W.Flood(81°)

Électronique

99376	99105	99115	99344
ON/OFF 1 - 2 art. p 138 x l 22 x h 21	ON/OFF 2 - 3 art. p 103 x l 58 x h 27	0/1-10V 1 - 3 art. p 210 x l 48 x h 25	DALI PUSH 1 - 4 art. p 210 x l 48 x h 25



RTG 96634W30 / 96634W60

Anton_R | Downlight | powerLED 6 W DC 630 mA

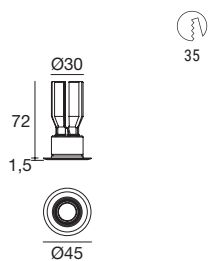

CRI 80

White 97418

Cct	Optic
Z	15 Spot -
	30 Flood -
	60 W.Flood -
	12 E.W.Flood-

Électronique

99743 + 99702	99333	DMX	Driver	Switching
Dimmer RF 1 - 12 art.	Dimmer DMX 2 - 12 art.	DMX Controllers CV 24V/48V Pag. 952 - 953	Driver CV 48V Pag. 941	Switching CV 48V Pag. 932



Downlight

Anton_R | Downlight | powerLED 8 W DC 630 mA

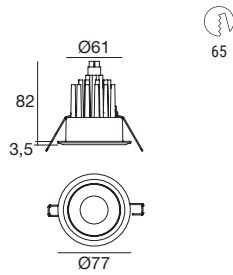

65

CRI 80

White **96635**

	Cct	lm S - D CRI 80	Optic
W	3000	932 - 694	15 Spot (17°)
N	4000	996 - 741	30 Flood (22°)
			60 W.Flood (60°)

Électronique

99376	99105	99115	99344
ON/OFF 1 art. p 134 x l 137 x h 31	ON/OFF 2 - 3 art. p 103 x l 58 x h 27	0/1-10V 1 - 2 art. p 210 x l 48 x h 25	DALI PUSH 1 - 3 art. p 210 x l 48 x h 25

Boîtier d'encastrement

89373 H. 83 - Ø. 200 **89374** H. 120 - Ø. 200

Anton_R | Downlight | powerLED 12 W DC 630 mA

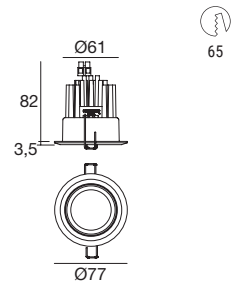

65

CRI 80

White **94586**

	Cct	lm S - D CRI 80	Optic
W	3000	1398 - 1171	30 Flood (29°)
N	4000	1494 - 1250	60 W.Flood (61°)
			12 E.W.Flood (86°)

Électronique

99129	99105	99115	99344
ON/OFF 1 art. p 134 x l 137 x h 31	ON/OFF 1 - 2 art. p 103 x l 58 x h 27	0/1-10V 1 art. p 210 x l 48 x h 25	DALI PUSH 1 - 2 art. p 210 x l 48 x h 25

Boîtier d'encastrement

89373 H. 83 - Ø. 200 **89374** H. 120 - Ø. 200

* avec boîtier d'encastrement pour brique creuse, réduction de la puissance à 9W DC 500 mA

Électronique

99128	99115	99344
ON/OFF 1 art. p 134 x l 137 x h 31	0/1-10V 1 - 2 art. p 210 x l 48 x h 25	DALI PUSH 1 - 2 art. p 210 x l 48 x h 25

Boîtier d'encastrement



description	type
89373 Boîtier d'encastrement	
suitable for: Anton_R 8W / Anton_R 12W	

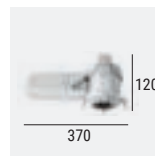

description	type
89374 Boîtier d'encastrement	
suitable for: Anton_R 8W / Anton_R 12W	

AntonX_1 | Downlight | arrayLED 18 W DC 500 mA

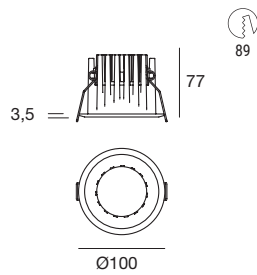

	CRI 92	CRI 80
White	80105	80107
Black	80106	80108

	Cct	lm S - D CRI 92	lm S - D CRI 80	Optic
M	2700	1885 - 1471	2323 - 1662	00 General (101°)
W	3000	2016 - 1574	2323 - 1662	
N	4000	2170 - 1694	2498 - 1787	

Électronique

99106	99115	99344
ON/OFF 1 art. p 103 x l 58 x h 27	0/1-10V 1 art. p 210 x l 48 x h 28	DALI PUSH 1 art. p 210 x l 48 x h 28

Boîtier d'encastrement

89373 H. 83 - Ø. 200 **89374** H. 120 - Ø. 200

* avec boîtier d'encastrement pour brique creuse, réduction de la puissance à 14,5W DC 400 mA

Électronique

99734	99732	99730
ON/OFF 1 art. p 134 x l 37 x h 31	0/1-10V 1 art. p 134 x l 37 x h 31	DALI PUSH 1 art. p 134 x l 37 x h 31

AntonX_2 | Downlight | arrayLED 25 W DC 700 mA

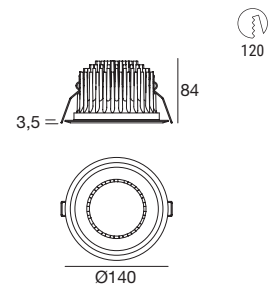

	CRI 92	CRI 80
White	80015	80013
Black	80016	80014

	Cct	lm S - D CRI 92	lm S - D CRI 80	Optic
M	2700	2598 - 1799	3210 - 2128	00 General (105°)
W	3000	2794 - 1936	3431 - 2274	
N	4000	2990 - 2070	3431 - 2274	

Électronique

99147	83008	99345
ON/OFF 1 art. p 103 x l 58 x h 27	0/1-10V DALI PUSH 1 art. p 124 x l 67 x h 22	DALI PUSH 1 art. p 210 x l 48 x h 28

Boîtier d'encastrement



description	type
89373 Boîtier d'encastrement	
suitable for: AntonX 18W	

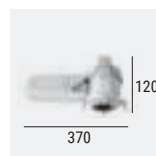

description	type
89374 Boîtier d'encastrement	
suitable for: AntonX 18W	

Anton_RJ | Downlight | powerLED 2 W DC 630 mA

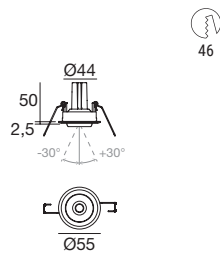

46

CRI 80

White **97402**

	Cct	lm S - D CRI 80	Optic
W	3000	233 - 142	08 N.Spot (8°)
N	4000	249 - 152	15 Spot (17°)
			30 Flood (22°)
			60 W.Flood (60°)
			12 E.W.Flood(110°)

Électronique

89147	99376	99105	99710	99713	+ driver 24V DC 99374 75W 99331 150W
ON/OFF 1 - 2 art. p 138 x l 22 x h 21	ON/OFF 3 - 6 art. p 138 x l 22 x h 21	ON/OFF 6 - 12 art. p 103 x l 58 x h 27	24V DC converter 0/1-10V 1 art. p 138 x l 22 x h 21	24V DC converter DALI 1 art. p 138 x l 22 x h 21	



Boîtier d'encastrement

89373 H. 83 - Ø. 200 **89374** H. 120 - Ø. 200

Anton_RJ | Downlight | powerLED 6 W DC 630 mA

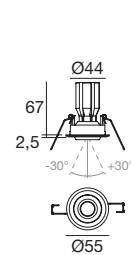

46

CRI 80

White **97404**

	Cct	lm S - D CRI 80	Optic
W	3000	699 - 454	15 Spot (17°)
N	4000	747 - 517	30 Flood (24°)
			60 W.Flood (57°)
			12 E.W.Flood(81°)

Électronique

99376	99105	99115	99344
ON/OFF 1 - 2 art. p 138 x l 22 x h 21	ON/OFF 2 - 3 art. p 103 x l 58 x h 27	0/1-10V 1 - 3 art. p 210 x l 48 x h 25	DALI PUSH 1 - 4 art. p 210 x l 48 x h 25



Boîtier d'encastrement

89373 H. 83 - Ø. 200 **89374** H. 120 - Ø. 200

* avec boîtier d'encastrement pour brique creuse, réduction de la puissance à 4,5 W DC 500mA

Électronique

99377	99106	99714	99715
ON/OFF 1 art. p 138 x l 22 x h 21	ON/OFF 2-3 art. p 103 x l 58 x h 27	0/1-10V 1 art. p 138 x l 22 x h 21	DALI 1 art. p 138 x l 22 x h 21

Boîtier d'encastrement



description	type
89373 Boîtier d'encastrement	
suitable for: Anton_RJ 2W / Anton_RJ 6W	

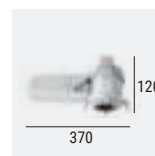

description	type
89374 Boîtier d'encastrement	
suitable for: Anton_RJ 2W / Anton_RJ 6W	

Anton_RJ | Downlight | powerLED 8 W DC 630 mA

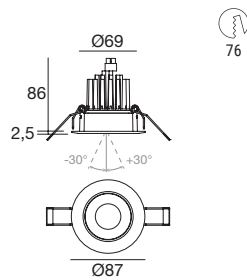

CRI 80

White **97427**

	Cct	lm S - D CRI 80	Optic
W	3000	932 - 694	15 Spot (17°)
N	4000	996 - 741	30 Flood (22°)
			60 W.Flood (60°)

Électronique

99376	99105	99115	99344
ON/OFF	ON/OFF	0/1-10V	DALI PUSH
1 art.	2-3 art.	1-2 art.	1-3 art.
p 134 x 137 x h 31	p 103 x 158 x h 27	p 210 x 148 x h 25	p 210 x 148 x h 25

Boîtier d'encastrement

89373 H. 83 - Ø. 200 **89374** H. 120 - Ø. 200

Anton_RJ | Downlight | powerLED 12 W DC 630 mA

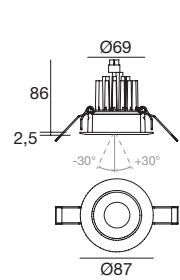

CRI 80

White **94592**

	Cct	lm S - D CRI 80	Optic
W	3000	1398 - 1171	30 Flood (29°)
N	4000	1494 - 1250	60 W.Flood(61°)
			12 E.W.Flood(86°)

Électronique

99129	99105	99115	99344
ON/OFF	ON/OFF	0/1-10V	DALI PUSH
1 art.	1-2 art.	1 art.	1-2 art.
p 134 x 137 x h 31	p 103 x 158 x h 27	p 210 x 148 x h 25	p 210 x 148 x h 25

Boîtier d'encastrement

89373 H. 83 - Ø. 200 **89374** H. 120 - Ø. 200

* avec boîtier d'encastrement pour brique creuse, réduction de la puissance à 9W DC 500mA

Électronique

99128	99115	99344
ON/OFF	0/1-10V	DALI PUSH
1 art.	1-2 art.	1-2 art.
p 134 x 137 x h 31	p 210 x 148 x h 25	p 210 x 148 x h 25

Boîtier d'encastrement



description	type
89373 Boîtier d'encastrement	
suitable for: Anton_RJ 8W / Anton_RJ 12W	

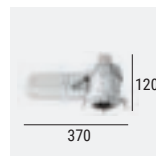

description	type
89374 Boîtier d'encastrement	
suitable for: Anton_RJ 8W / Anton_RJ 12W	



woofer

Matériaux
Corps en aluminium

woofer range



	Woofer_R	Woofer_RX
13W	Ø 182 mm	-
17,5W	Ø 182 mm	-
24,5W	Ø 182 mm	Ø 218 mm
30,5W	-	Ø 218 mm
Finish	White	White
CRI 80	2700K - 3000K - 4000K	2700K - 3000K - 4000K
Optics	Spot - Wide Flood - Asymmetric - General	Spot - Wide Flood - Asymmetric - General
Driver	On/Off	On/Off
	162mm	197mm

Woofers_R | Downlight | 100-240 V AC | arrayLED 13 W DC - 15 W AC

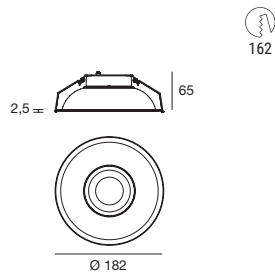

162

CRI 92

White 84230

	Cct	lm S - D CRI 92	Optic
M	2700	1322 - On req.	20 Spot -
W	3000	1385 - On req.	60 W.Flood-
N	4000	1488 - On req.	07 Asymm.-
			00 General -

CRI 80

White 84209

	Cct	lm S - D CRI 80	Optic
M	2700	1561 - On req.	20 Spot -
W	3000	1627 - On req.	60 W.Flood-
N	4000	1718 - On req.	07 Asymm.-
			00 General -

Woofers_R | Downlight | 100-240 V AC | arrayLED 24,5 W DC - 27,5 W AC

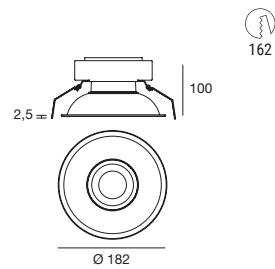

162

CRI 92

White 84232

	Cct	lm S - D CRI 92	Optic
M	2700	2808 - On req.	20 Spot -
W	3000	2941 - On req.	60 W.Flood-
N	4000	3161 - On req.	07 Asymm.-
			00 General -

CRI 80

White 84211

	Cct	lm S - D CRI 80	Optic
M	2700	3337 - On req.	20 Spot -
W	3000	3478 - On req.	60 W.Flood-
N	4000	3672 - On req.	07 Asymm.-
			00 General -

Woofers_R | Downlight | 100-240 V AC | arrayLED 17,5 W DC - 20 W AC

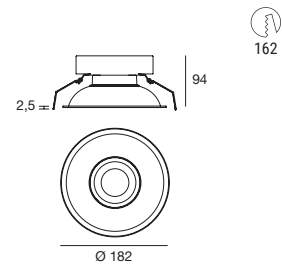

162

CRI 92

White 84231

	Cct	lm S - D CRI 92	Optic
M	2700	2124 - On req.	20 Spot -
W	3000	2224 - On req.	60 W.Flood-
N	4000	2390 - On req.	07 Asymm.-
			00 General -

CRI 80

White 84210

	Cct	lm S - D CRI 80	Optic
M	2700	2524 - On req.	20 Spot -
W	3000	2630 - On req.	60 W.Flood-
N	4000	2777 - On req.	07 Asymm.-
			00 General -



Asymmetric Optics

RTG 84210W60 / 84210N60 / 84231W60 / 84231N60

RTG 84211W60 / 84211N60 / 84232W60 / 84232N60

Woofler_RX | Downlight | 100-240 V AC | arrayLED 24,5 W DC - 28 W AC

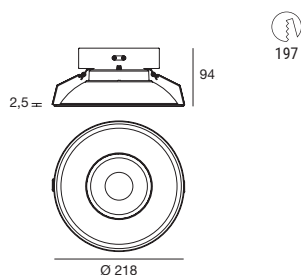

197

CRI 92

White **84228**

	Cct	lm S - D CRI 92	Optic
M	2700	2808 - On req.	20 Spot -
W	3000	2941 - On req.	60 W.Flood-
N	4000	3161 - On req.	07 Asymm.-
			00 General -

CRI 80

White **84207**

	Cct	lm S - D CRI 80	Optic
M	2700	3337 - On req.	20 Spot -
W	3000	3478 - On req.	60 W.Flood-
N	4000	3672 - On req.	07 Asymm.-
			00 General -

Woofler_RX | Downlight | 100-240 V AC | arrayLED 30,5 W DC - 34 W AC

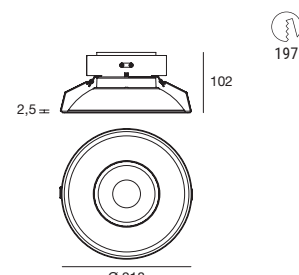

197

CRI 92

White **84229**

	Cct	lm S - D CRI 92	Optic
M	2700	3758 - On req.	20 Spot -
W	3000	3937 - On req.	60 W.Flood-
N	4000	4232 - On req.	07 Asymm.-
			00 General -

CRI 80

White **84208**

	Cct	lm S - D CRI 80	Optic
M	2700	4469 - On req.	20 Spot -
W	3000	4656 - On req.	60 W.Flood-
N	4000	4915 - On req.	07 Asymm.-
			00 General -



W.Flood Optics



General Optics



LV44

Matériaux
Corps en aluminium

2700-6000K

DYNAMICWHITE

Des études scientifiques ont montré que la réplique des mêmes fréquences que la lumière du soleil, dans des environnements publics fermés peut s'avérer bénéfique à ceux qui vivent et travaillent dans ces lieux.

Driver DALI

Les articles LV44 en version dynamic white peuvent être gérés via un driver DALI avec firmware 8.8. Ce driver permet d'utiliser 8 adresses sur le même hardware.



2700 K
Super warm white
6500 K
Cold white

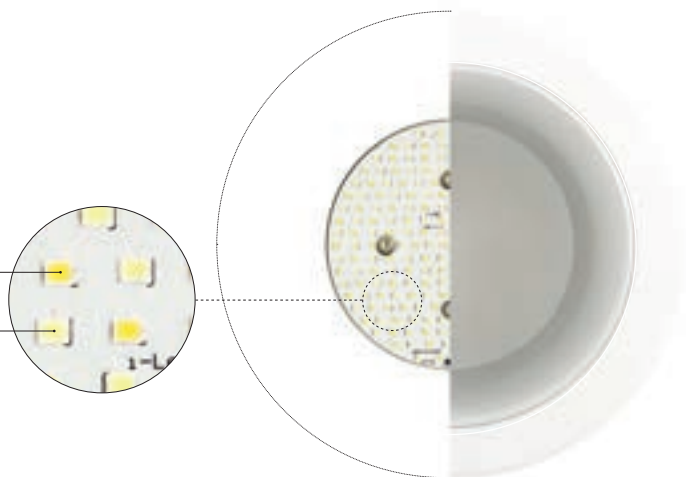

Mélange de couleurs

La technologie de mélange de couleurs développée par Linea Light Group permet de réguler au mieux la Cct de la lumière émise grâce au diffuseur opalin qui, avec l'aide de la source particulièrement en retrait, sert de premier « stabilisateur », garantissant ainsi la température de couleur souhaitée. En outre, le système de contrôle de l'émission via protocole DALI fourni par Linea Light Group permet de réguler la Cct directement au niveau de la source lumineuse.



Éclairage intelligent

Les modules Dynamic White, associés aux nouveaux systèmes de gestion spécifiquement développés, permettent de mélanger les nuances de blanc allant de Warm White à Cold White. Il est donc possible, avec un seul produit, de reproduire toutes les températures de couleur de 2700 K à 6500 K, en maintenant le même flux lumineux. Des études récentes sur les cycles circadiens ont démontré comment les variations de la température de la lumière naturelle, du lever au coucher du soleil, affectaient le bien-être des personnes.

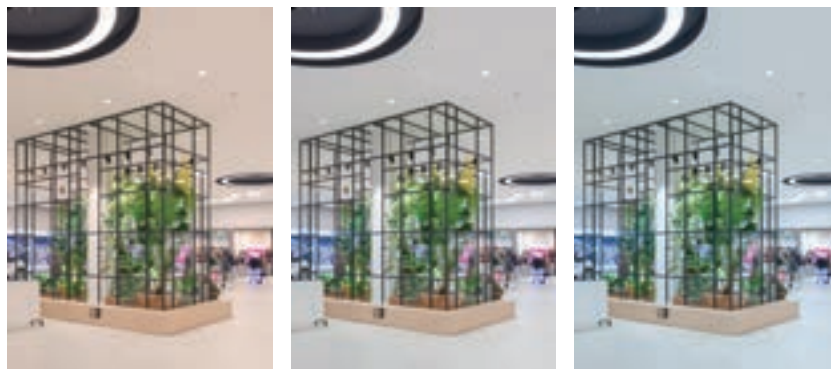

2700K

6500K

LV44_RD | Downlight | topLED 10 W DC 350 mA

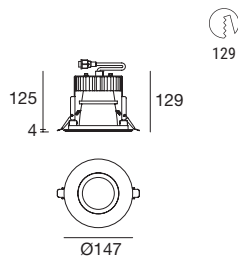

CRI 80

White	91769
Black	91776

Optic

D	2700 K - 6500 K	Dynamic	00 General (84°)
----------	-----------------	---------	-------------------------

Électronique

83058	99741 + 99701	99333	DMX	Driver CV
DALI 1 art. p 153 x 176 x h 30	Dimmer RF 1 - 2 art.	Dimmer DMX 1 - 2 art.	Controllers Pag 952 - 953	CV 48V Pag 941

LV44_RD | Downlight | topLED 20 W DC 600 mA

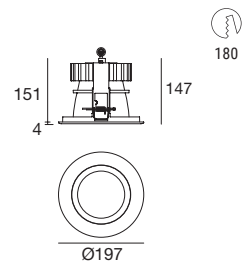
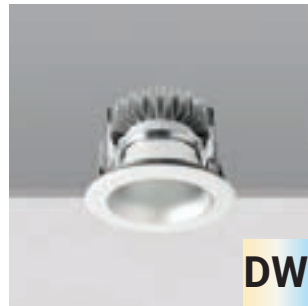

CRI 80

White	91777
Black	91778

Optic

D	2700 K - 6500 K	Dynamic	00 General (84°)
----------	-----------------	---------	-------------------------

Électronique

83059	99743 + 99701	99333	DMX	Driver CV
DALI 1 art. p 153 x 176 x h 30	Dimmer RF 1 - 2 art.	Dimmer DMX 1 - 2 art.	Controllers Pag 952 - 953	CV 48V Pag 941

LV44_RD | Downlight | topLED 30 W DC 840 mA

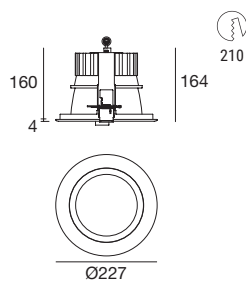

CRI 80

White	91779
Black	91780

Optic

D	2700 K - 6500 K	Dynamic	00 General -
----------	-----------------	---------	---------------------

Électronique

83060	99333	DMX	Driver CV
DALI 1 art. p 153 x 176 x h 30	Dimmer DMX 1 - 2 art.	Controllers Pag 952 - 953	CV 48V Pag 941

LV44_RD | Downlight | topLED 45 W DC 1250 mA

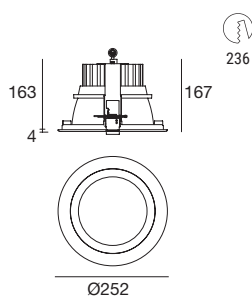

CRI 80

White	91781
Black	91783

Optic

D	2700 K - 6500 K	Dynamic	00 General -
----------	-----------------	---------	---------------------

Électronique
83061

DALI
1 art.
p 153 x 176 x h 30

LV44_RD | Downlight | topLED 65 W DC 1800 mA

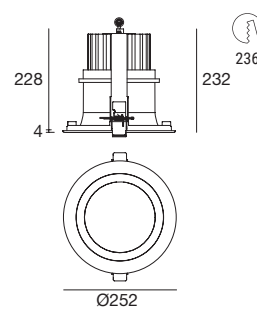

CRI 80

White	90746
Black	90747

Optic

D	2700 K - 6500 K	Dynamic	00 General -
----------	-----------------	---------	---------------------

Électronique
99727 x2

DALI
1 art.
p 220 x 171 x h 38

EXEMPLE DE SYSTÈME DE GESTION



LV54 HV44

Matériaux

Corps en aluminium

Diffuseur PMMA opalin



LV54_RS | Downlight | topLED 13 W DC 350 mA



121



CRI 80

White 97090

	Cct	lm S - D CRI 80	Optic
M	2700	1344 - 1200	00 General (113°)
W	3000	1488 - 1328	
N	4000	1632 - 1457	

Électronique

99260	99262	99721
ON/OFF	0/1-10V	DALI PUSH
1 art.	1 art.	1 art.
p 134 x 137 x h 31	p 210 x 148 x h 25	p 210 x 148 x h 25

RTG 97090W00 / 97090N00

LV54_RS | Downlight | topLED 30 W DC 840 mA



197

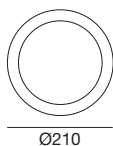
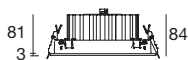

CRI 80

White 97094

	Cct	lm S - D CRI 80	Optic
M	2700	3024 - 2772	00 General (112°)
W	3000	3348 - 3069	
N	4000	3672 - 3366	

Électronique

99093	83066	99330
ON/OFF	0/1-10V DALI PUSH	DALI PUSH
1 art.	1 art.	1 art.
p 103 x 158 x h 27	p 124 x 167 x h 22	p 210 x 148 x h 28

RTG 97094W00 / 97094N00

LV54_RS | Downlight | topLED 23 W DC 630 mA



167



CRI 80

White 97092

	Cct	lm S - D CRI 80	Optic
M	2700	2352 - 2163	00 General (112°)
W	3000	2604 - 2395	
N	4000	2856 - 2626	

Électronique

99261	99262	99721
ON/OFF	0/1-10V	DALI PUSH
1 art.	1 art.	1 art.
p 103 x 158 x h 27	p 210 x 148 x h 28	p 210 x 148 x h 28

RTG 97092W00 / 97092N00

LV54_RS | Downlight | topLED 45 W DC 1250 mA



236

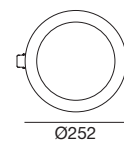
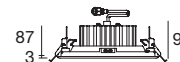

CRI 80

White 97119

	Cct	lm S - D CRI 80	Optic
M	2700	4704 - 4227	00 General (112°)
W	3000	5208 - 4680	
N	4000	5712 - 5133	

Électronique

83114	83066
ON/OFF	0/1-10V DALI PUSH
1 art.	1 art.
p 160 x 170 x h 36	p 124 x 167 x h 22

LV54_QS | Downlight | topLED 13 W DC 350 mA

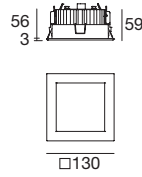

CRI 80

White **97096**

	Cct	lm S - D CRI 80	Optic
M	2700	1344 - 1254	00 General (111°)
W	3000	1488 - 1388	
N	4000	1632 - 1523	

Électronique

99260	99262	99721
ON/OFF	0/1-10V	DALI PUSH
1 art.	1 art.	1 art.
p 134 x l 37 x h 31	p 210 x l 48 x h 25	p 210 x l 48 x h 25

RTG 97096W00 / 97096N00

LV54_QS | Downlight | topLED 30 W DC 840 mA

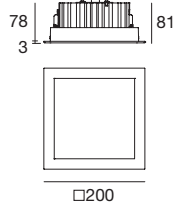

CRI 80

White **97100**

	Cct	lm S - D CRI 80	Optic
M	2700	2904 - 2800	00 General (112°)
W	3000	3300 - 3182	
N	4000	3564 - 3436	

Électronique

99093	83066	99330
ON/OFF	0/1-10V DALI PUSH	DALI PUSH
1 art.	1 art.	1 art.
p 103 x l 58 x h 27	p 124 x l 67 x h 22	p 210 x l 48 x h 28

LV54_QS | Downlight | topLED 23 W DC 630 mA

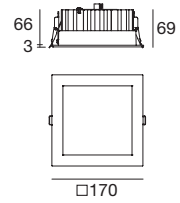

CRI 80

White **97098**

	Cct	lm S - D CRI 80	Optic
M	2700	2475 - 2301	00 General (111°)
W	3000	2772 - 2577	
N	4000	2970 - 2761	

Électronique

99261	99262	99721
ON/OFF	0/1-10V	DALI PUSH
1 art.	1 art.	1 art.
p 103 x l 58 x h 27	p 210 x l 48 x h 28	p 210 x l 48 x h 28

RTG 97098W00 / 97098N00

HV44 | Downlight | 190-240 V | topLED 5 W AC

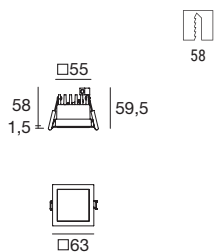

CRI 80

White	97710
Black	97711
Grey	97712

	Cct	lm S - D CRI 80	Optic
W	3000	570 - 232	00 General (114°)
N	4000	610 - 248	

RTG 97710W00

HV44 | Downlight | 190-240 V | topLED 10 W AC

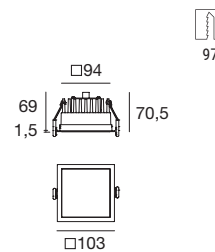

CRI 80

White	97730
Black	97731
Grey	97732

	Cct	lm S - D CRI 80	Optic
W	3000	980 - 492	00 General (114°)
N	4000	1045 - 524	

RTG 97730W00

Branchement direct

La particularité de la série HV44 est qu'elle dispose de circuits conçus pour le branchement direct à la tension secteur 220 V. Aucune driver n'est nécessaire, ce qui simplifie la maintenance de l'appareil.





rada

Materiaux

Corps en aluminium
Diffuseur en aluminium
finition blanc optique



rada range

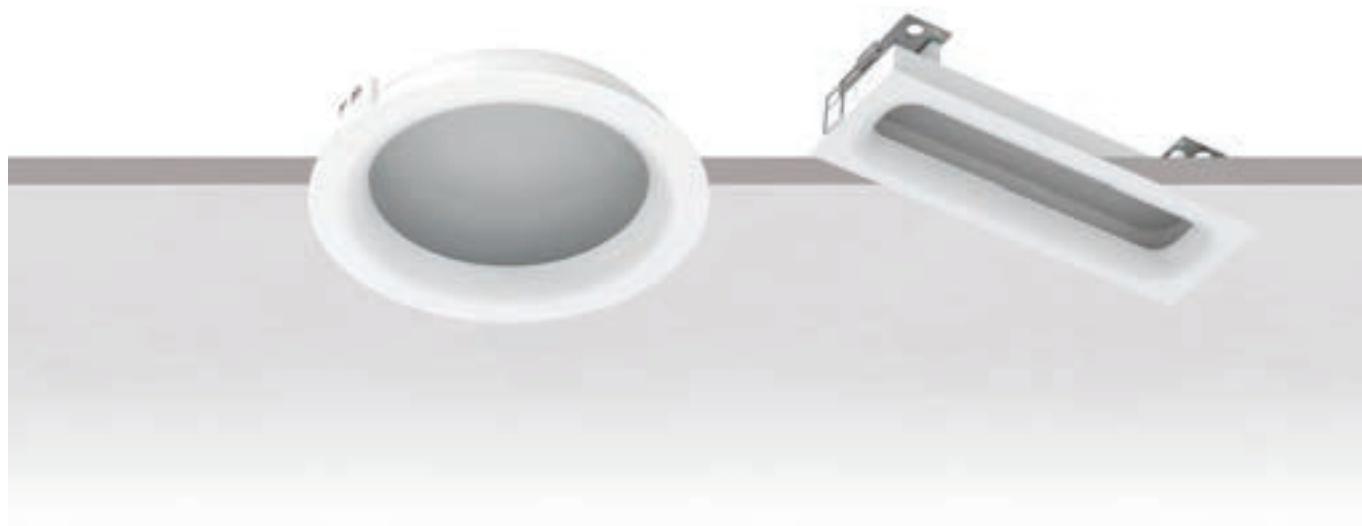

	_R Round	_Q Square
8W	Ø 116 mm	-
12W	Ø 177 mm	□ 212x73 mm
18W	Ø 233 mm	-
23W	-	□ 362x73 mm
25W	Ø 310 mm	-
65W	Ø 600 mm	-
82W	Ø 800 mm	-
Finish	White	White
CRI 80	2700K - 3000K - 4000K	2700K - 3000K - 4000K
Optics	General	General
Driver	On/Off - 1/10 V - DALI	On/Off - 1/10 V - DALI
	107 mm - 169 mm - 224 mm 303 mm - 580 mm - 780 mm	202x62 mm 352x62 mm

Confort visuel

Un circuit de LED périphérique, dissimulé dans la partie intérieure du cadre circulaire, dirige la lumière vers le haut ; celle-ci est captée par le réflecteur optique à dôme en aluminium finition blanche, qui la redistribue dans la pièce. L'effet final correspond à un éclairage indirect et diffus très doux. L'absence totale d'éblouissement permet d'observer directement le produit sans gêne pour les yeux.



Diffusion rasante

Grâce à la réflexion interne étudiée à cet effet, Rada garantit une diffusion rase presque le plafond et distribue la lumière dans tout l'espace.

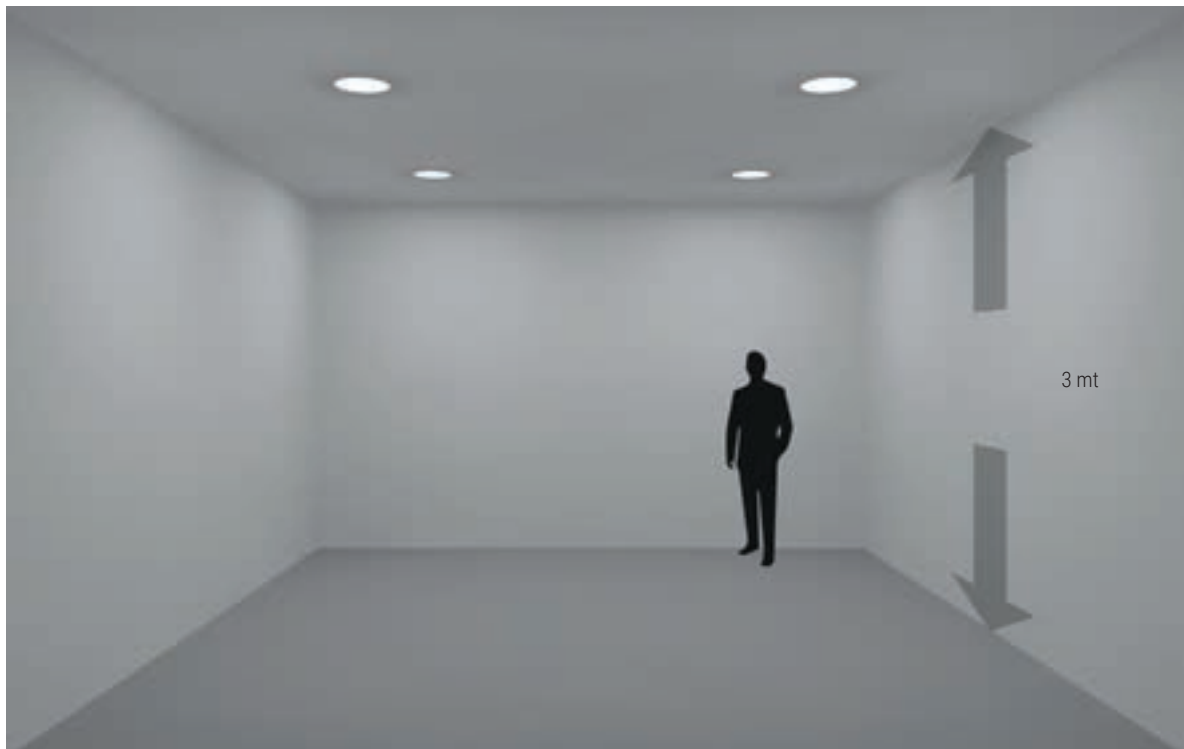

Rada_R | Downlights | topLED 8 W DC 220 mA

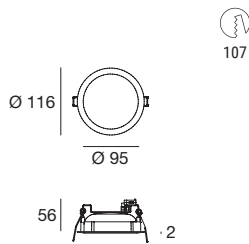

107

CRI 80

White 91992

	Cct	lm S - D CRI 80	Optic
M	2700	955 - 372	00 General (131°)
W	3000	1022 - 398	
N	4000	1070 - 416	

Électronique

99198	99732	99730
ON/OFF	0/1-10V	DALI PUSH
1 art.	1 art.	1 art.
p 134 x 137 x h 31	p 134 x 137 x h 31	p 134 x 137 x h 31

Accessoires Pag. 126

98436 Easy-plug

Rada_R | Downlights | topLED 18 W DC 500 mA

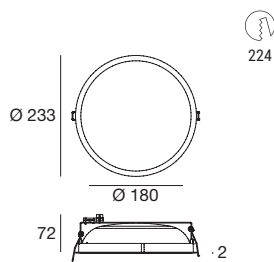

224

CRI 80

White 92000

	Cct	lm S - D CRI 80	Optic
M	2700	2462 - 1408	00 General (143°)
W	3000	2520 - 1436	
N	4000	2693 - 1544	

Électronique

99106	99115	99344
ON/OFF	0/1-10V	DALI PUSH
1 art.	1 art.	1 art.
p 103 x 158 x h 27	p 210 x 148 x h 28	p 210 x 148 x h 28

Accessoires Pag. 126

98436 Easy-plug

Rada_R | Downlights | topLED 12 W DC 350 mA

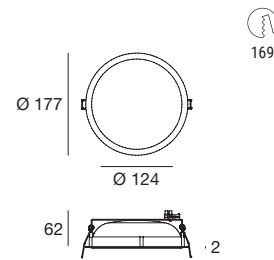

169

CRI 80

White 91996

	Cct	lm S - D CRI 80	Optic
M	2700	1642 - 978	00 General (135°)
W	3000	1680 - 996	
N	4000	1795 - 1072	

Électronique

99126	99115	99344
ON/OFF	0/1-10V	DALI
1 art.	1 art.	1 art.
p 134 x 137 x h 30	p 210 x 148 x h 25	p 210 x 148 x h 25

Accessoires Pag. 126

98436 Easy-plug

Rada_R | Downlights | topLED 25 W DC 700 mA

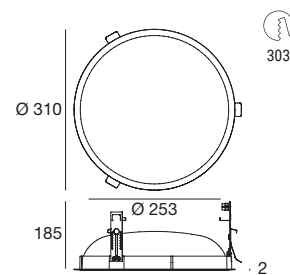

303

CRI 80

White 92004

	Cct	lm S - D CRI 80	Optic
M	2700	3283 - 2033	00 General (142°)
W	3000	3360 - 2072	
N	4000	3590 - 2228	

Électronique

99147	83008	99345
ON/OFF	0/1-10V DALI PUSH	DALI PUSH
1 art.	1 art.	1 art.
p 103 x 158 x h 27	p 124 x 167 x h 22	p 210 x 148 x h 28

Accessoires Pag. 126

98436 Easy-plug

Rada_R | Downlights | topLED 65 W DC 1800 mA

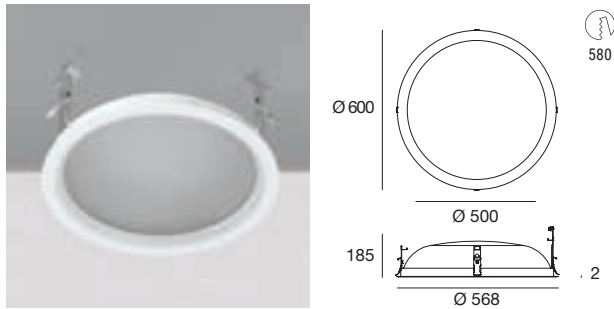

CRI 80

White **93854**

	Cct	lm S - D CRI 80	Optic
M	2700	9792 - 6777	00 General (147°)
W	3000	10253 - 7096	
N	4000	10714 - 7415	

Électronique

99717	99726	99727
ON/OFF 1 art. p 208 x l 89 x h 40	0/1-10V DALI PUSH 1 art. p 170 x l 68 x h 39	0/1-10V DALI PUSH 1 art. p 170 x l 68 x h 39

Accessoires Pag. 126

98436 Easy-plug

Rada_R | Downlights | topLED 82 W DC 2260 mA

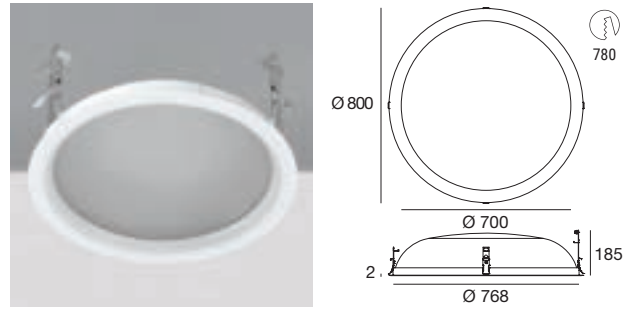

CRI 80

White **93862**

	Cct	lm S - D CRI 80	Optic
M	2700	12240 - 8797	00 General (147°)
W	3000	12816 - 9373	
N	4000	13392 - 9789	

Électronique

99718	99728	99729
ON/OFF 1 art. p 208 x l 89 x h 40	0/1-10V DALI PUSH 1 art. p 220 x l 68 x h 39	DALI PUSH 1 art. p 220 x l 68 x h 39

Accessoires Pag. 126

98436 Easy-plug

92004W00

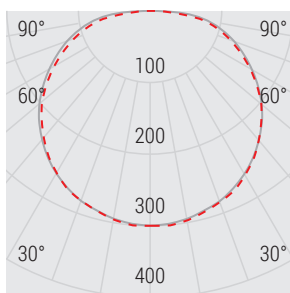

Courbe photométrique

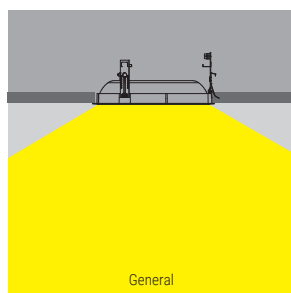

Faisceau lumineux

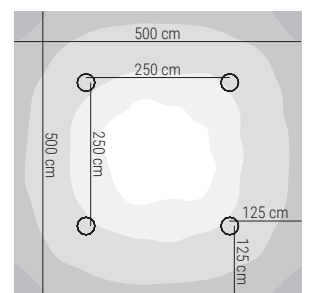
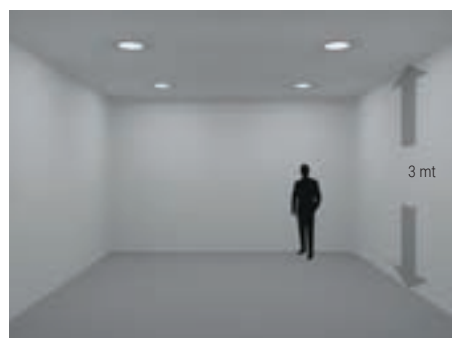

Planimétrie

93862W00

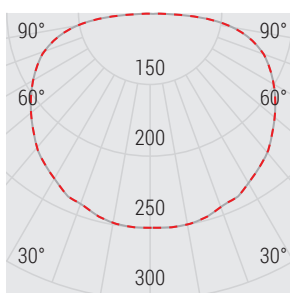

Courbe photométrique

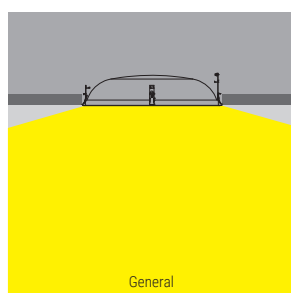

Faisceau lumineux

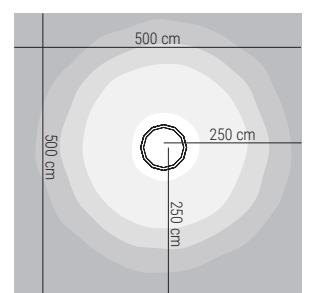
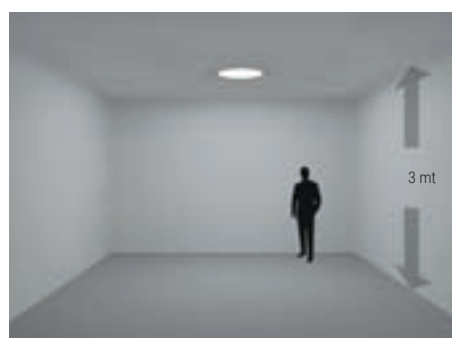

Planimétrie

Rada_Q | Downlights | topLED 12 W DC 350 mA

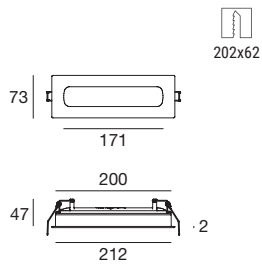

CRI 80

White **92432**

	Cct	lm S - D CRI 80	Optic
M	2700	1706 - 648	00 General (111°)
W	3000	1829 - 694	
N	4000	1915 - 727	

Électronique

99260	99262	99721
ON/OFF	0/1-10V	DALI PUSH
1 art.	1 art.	1 art.
p 134 x l 37 x h 31	p 210 x l 48 x h 25	p 210 x l 48 x h 25

Rada_Q | Downlights | topLED 23 W DC 630 mA

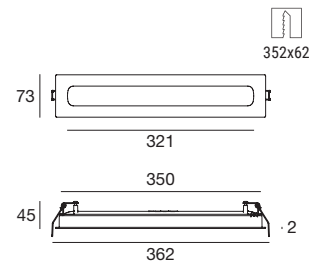

CRI 80

White **92434**

	Cct	lm S - D CRI 80	Optic
M	2700	2866 - 1272	00 General (117°)
W	3000	3067 - 1364	
N	4000	3211 - 1427	

Électronique

99261	99262	99721
ON/OFF	0/1-10V	DALI PUSH
1 art.	1 art.	1 art.
p 103 x l 58 x h 27	p 210 x l 48 x h 28	p 210 x l 48 x h 28

92434W00

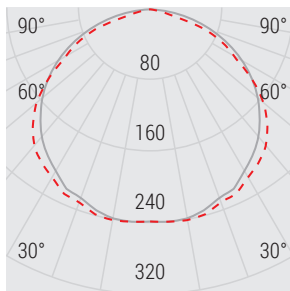

Courbe photométrique

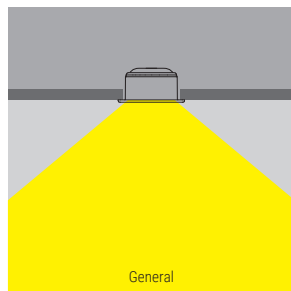

Faisceau lumineux

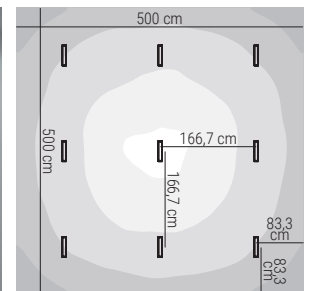
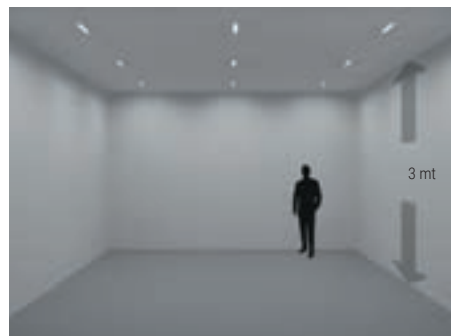

Planimétrie

Accessoires



	description
98436	Easy-plug





cell

Matériaux

Corps en aluminium

La version Gypsum_Cell dispose d'un boîtier d'encastrement avec cadre en plâtre

000001

000001



cell range

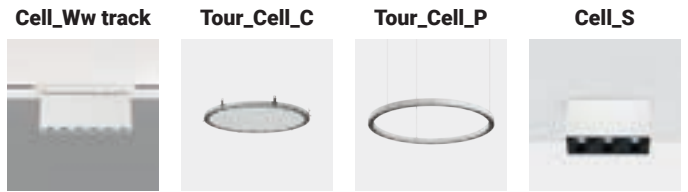

Pag. 199

Pag. 233

Pag. 242

Pag. 277

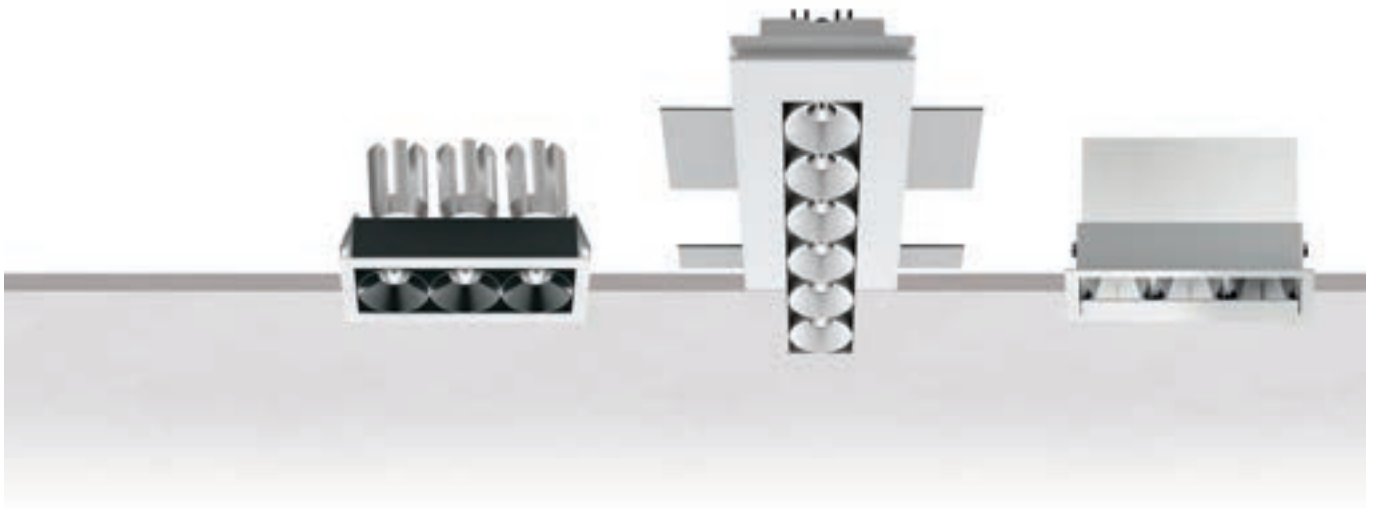

	Cell	Gypsum_Cell	Cell_Ww
1 x powerLED	2W/4W 50x50 mm	2W/4W 75x75 mm	-
3 x powerLED	6W/12W 119x50 mm	6W/12W 150x80 mm	9,5W 120x50 mm
6 x powerLED	12W 221x50 mm	12W 260x80 mm	18W 225x50 mm
9 x powerLED	18W 119x119 mm	18W 150x150 mm	-
12 x powerLED	-	-	32,5W 435x50 mm
Finish	<input type="checkbox"/> White <input type="checkbox"/> Wh <input checked="" type="checkbox"/> Bk	<input type="checkbox"/> White <input checked="" type="checkbox"/> Black	<input type="checkbox"/> White <input checked="" type="checkbox"/> Black
CRI 92 CRI 80	2700K - 3000K - 4000K	2700K - 3000K - 4000K	2700K - 3000K - 4000K
Optics	Spot - Flood	Spot - Flood	Asymmetric
Driver	On/Off - 1/10V - DALI	On/Off - 1/10V - DALI	On/Off - 1/10V - DALI
	42x42 mm - 113x40 mm 215x42 mm - 113x113 mm	85x85 mm - 160x90 mm 270x90 mm - 160x160 mm	114x40 mm - 219x40 mm 432x42 mm

Micro-optique CELL

La maille carrée particulière à facettes convexes qui caractérise la surface des microrélecteurs est capable de contrôler chaque rayon lumineux et de produire ainsi une émission de 15°, 30° ou 45° selon la version.

Dissipateur en aluminium extrudé anodisé noir

Cadre en plâtre (version Gypsum)

Cavités cut-off en polycarbonate

Micro-optiques en polycarbonate métallisé

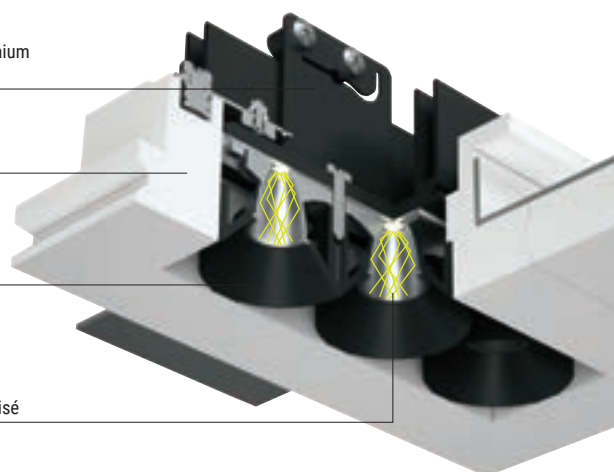

Installation rapide

La version Gypsum_Cell dispose d'un boîtier d'encastement avec cadre en plâtre, conçu pour être installé sur un faux plafond. Le système d'accouplement rapide magnétique permet de positionner facilement les unités lumineuses qui peuvent être peintes, pour une intégration totale avec l'architecture.

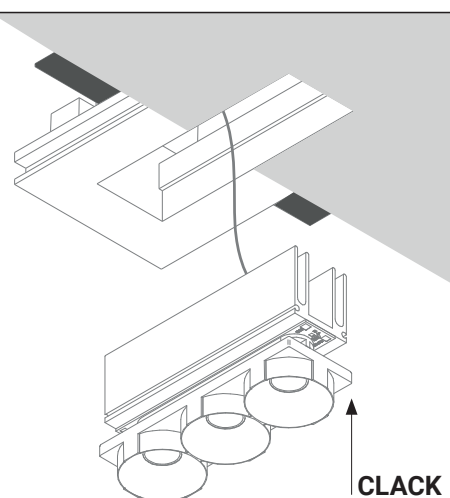

Large gamme de produits

Les différentes versions de Cell et Gypsum_Cell sont conçues pour répondre à de multiples besoins d'éclairage. Au boîtier d'encastement à une cellule s'ajoutent les options à trois ou six cellules disposées linéairement, ou à neuf cellules disposées en carré. La nouveauté consiste en l'introduction des versions asymétriques Cell_Ww, conçues pour l'éclairage mural, disponibles dans les configurations linéaires à 3, 6 et 12 cellules.

Version Frame, Gypsum

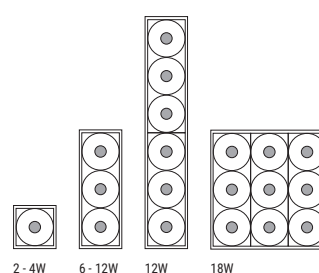

Version Asymmetric

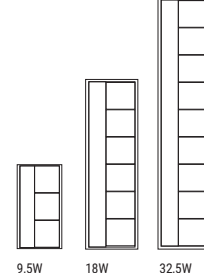

Nouvelle optique lèche-mur

Le compartiment optique Cell_Ww est conçu pour garantir un éclairage lèche-mur propre et précis. Les cellules cut-off sont structurées pour projeter la lumière vers le mur, à partir du sommet, avec un faisceau aux contours nets et définis qui s'étale progressivement sur toute la surface ; l'ouverture du faisceau atteint les 90°, ce qui permet d'éclairer également la zone de passage à côté au mur. Une paupière fixe, légèrement relevée pour éliminer la luminance des cellules, recouvre partiellement le compartiment optique, définit l'angle d'émission et élimine toute lumière parasite.



Gypsum Cell | Downlights | powerLED 2 W DC 630 mA

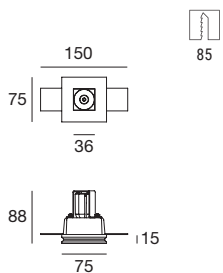
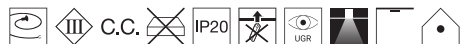

CRI 80/92

White	64630
Black	64631

	Cct	lm S - D CRI 80	lm S - D CRI 92	Optic
M	2700	-	157 - 134	15 Spot (13°)
W	3000	-	179 - 154	30 Flood (32°)
N	4000	249 - 200	-	45 Flood (48°)

Électronique

89147	99376	99105	99710	99713	+ driver 24V DC 99374 75W 99331 150W
ON/OFF 1 - 2 art. p 138 x 122 x h 21	ON/OFF 3 - 6 art. p 138 x 122 x h 21	ON/OFF 6 - 12 art. p 103 x 158 x h 27	24V DC converter 0/1-10V 1 art. p 138 x 122 x h 21	24V DC converter DALI 1 art. p 138 x 122 x h 21	

Gypsum Cell | Downlights | powerLED 4 W DC 350 mA

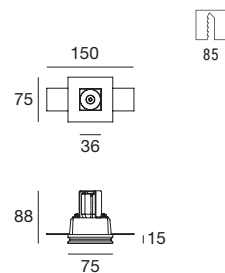
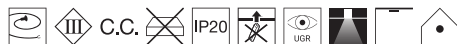

CRI 80

White	64632
Black	64633

	Cct	lm S - D CRI 80	Optic
M	2700	490 - 387	15 Spot (15°)
W	3000	490 - 387	30 Flood (33°)
N	4000	529 - 418	45 Flood (47°)

Électronique

89145	99375	99708	99711	+ driver 24V DC 99374 75W 99331 150W
ON/OFF 1 art. p 138 x 122 x h 21	ON/OFF 2 - 3 art. p 138 x 122 x h 21	0/1-10V converter 1 art. p 138 x 122 x h 21	DALI converter 1 art. p 138 x 122 x h 21	

Gypsum Cell | Downlights | 3 x powerLEDs 2 W | 6 W DC 630 mA

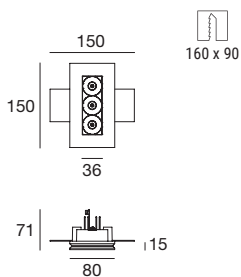

CRI 80/92

White	64547
Black	64546

	Cct	lm S - D CRI 80	lm S - D CRI 92	Optic
M	2700	-	471 - 409	15 Spot (12°)
W	3000	-	537 - 500	30 Flood (32°)
N	4000	747 - 532	-	45 Flood (49°)

Électronique

99376	99105	99115	99344
ON/OFF 1 - 2 art. p 138 x 122 x h 21	ON/OFF 2 - 3 art. p 103 x 158 x h 27	0/1-10V 1 - 3 art. p 210 x 148 x h 25	DALI PUSH 1 - 4 art. p 210 x 148 x h 25

RTG 64547W30 / 64546W30

Gypsum Cell | Downlights | 3 x powerLEDs 4 W | 12 W DC 350 mA

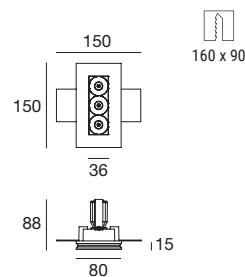

CRI 80

White	64637
Black	64638

	Cct	lm S - D CRI 80	Optic
M	2700	1470 - 1123	15 Spot (15°)
W	3000	1470 - 1123	30 Flood (34°)
N	4000	1587 - 1213	45 Flood (47°)

Électronique

99126	99115	99344
ON/OFF 1 art. p 134 x 137 x h 30	0/1-10V 1 art. p 210 x 148 x h 25	DALI 1 art. p 210 x 148 x h 25

Gypsum Cell | Downlights | 6 x powerLEDs 2 W | 12 W DC 630 mA

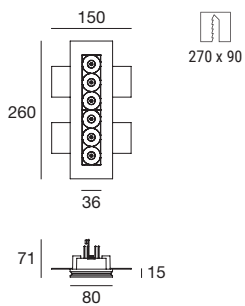

CRI 80/92

White	64549
Black	64548

	Cct	lm S - D CRI 80	lm S - D CRI 92	Optic
M	2700	-	942 - 852	15 Spot (12°)
W	3000	-	1074 - 907	30 Flood (32°)
N	4000	1494 - 965	-	45 Flood (49°)

Électronique

99129	99105	99115	99344
ON/OFF 1 art. p 134 x 137 x h 31	ON/OFF 1 - 2 art. p 103 x 158 x h 27	0/1-10V 1 art. p 210 x 148 x h 25	DALI PUSH 1 - 2 art. p 210 x 148 x h 25

RTG 64549W30 / 64548W30

Gypsum Cell | Downlights | 9 x powerLEDs 2 W | 18 W DC 630 mA

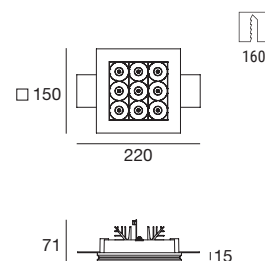

CRI 80/92

White	64551
Black	64550

	Cct	lm S - D CRI 80	lm S - D CRI 92	Optic
M	2700	-	1413 - 1342	15 Spot (14°)
W	3000	-	1611 - 1361	30 Flood (26°)
N	4000	2241 - 1448	-	45 Flood (49°)

Électronique

99105	99115	99344
ON/OFF 1 art. p 103 x 158 x h 27	0/1-10V 1 art. p 210 x 148 x h 28	DALI PUSH 1 art. p 210 x 148 x h 28

Accessoires

Entretoise



60830 100x19 mm

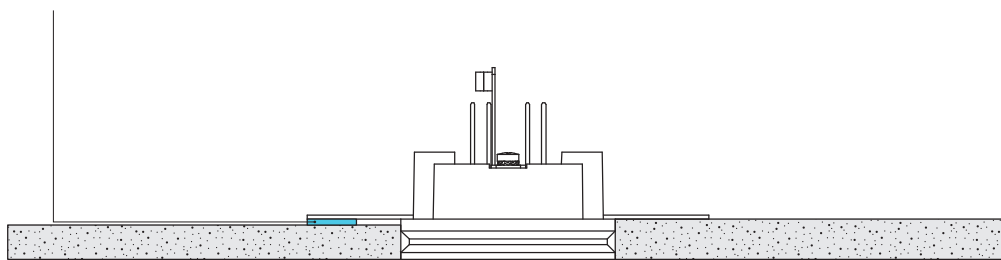

ÉPAISSEUR STANDARD = 13 mm

ÉPAISSEUR SPÉCIALE ≤ 15 mm

Cell | Downlights | powerLED 2 W DC 630 mA

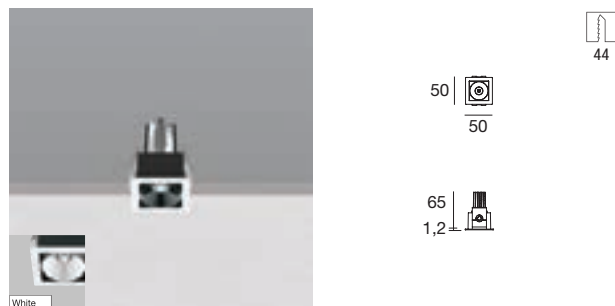
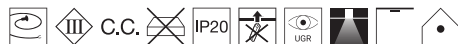

CRI 80/92

White	64507
Black	64508

	Cct	lm S - D CRI 80	lm S - D CRI 92	Optic
M	2700	-	157 - 134	15 Spot (13°)
W	3000	-	179 - 154	30 Flood (32°)
N	4000	249 - 200	-	45 Flood (48°)

Électronique

89147	99376	99105	99710	99713	+ driver 24V DC 99374 75W 99331 150W
ON/OFF 1 - 2 art. p 138 x 122 x h 21	ON/OFF 3 - 6 art. p 138 x 122 x h 21	ON/OFF 6 - 12 art. p 103 x 158 x h 27	24V DC converter 0/1-10V 1 art. p 138 x 122 x h 21	24V DC converter DALI 1 art. p 138 x 122 x h 21	

Cell | Downlights | powerLED 4 W DC 350 mA

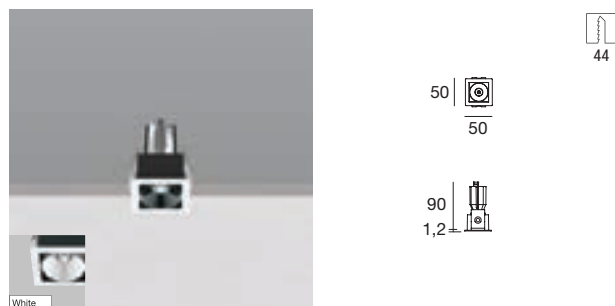
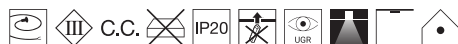

CRI 80

White	64526
Black	64527

	Cct	lm S - D CRI 80	Optic
M	2700	490 - 387	15 Spot (15°)
W	3000	490 - 387	30 Flood (33°)
N	4000	529 - 418	45 Flood (47°)

Électronique

89145	99375	99708	99711	+ driver 24V DC 99374 75W 99331 150W
ON/OFF 1 art. p 138 x 122 x h 21	ON/OFF 2 - 3 art. p 138 x 122 x h 21	0/1-10V converter 1 art. p 138 x 122 x h 21	DALI converter 1 art. p 138 x 122 x h 21	

Cell | Downlights | 3 x powerLEDs 2 W | 6 W DC 630 mA

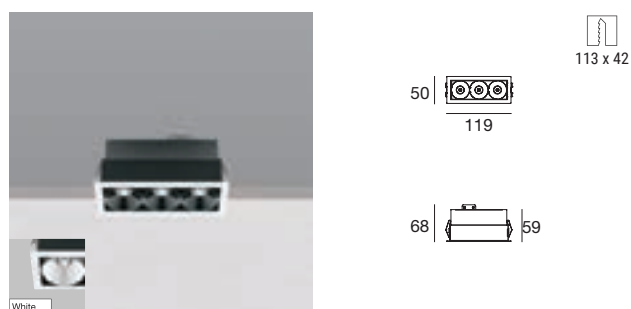

CRI 80/92

White	64541
Black	64540

	Cct	lm S - D CRI 80	lm S - D CRI 92	Optic
M	2700	-	471 - 409	15 Spot (12°)
W	3000	-	537 - 500	30 Flood (32°)
N	4000	747 - 532	-	45 Flood (49°)

Électronique

99376	99105	99115	99344
ON/OFF 1 - 2 art. p 138 x 122 x h 21	ON/OFF 2 - 3 art. p 103 x 158 x h 27	0/1-10V 1 - 3 art. p 210 x 148 x h 25	DALI PUSH 1 - 4 art. p 210 x 148 x h 25

RTG 64541W30 / 64540W30

Cell | Downlights | 3 x powerLEDs 4 W | 12 W DC 350 mA

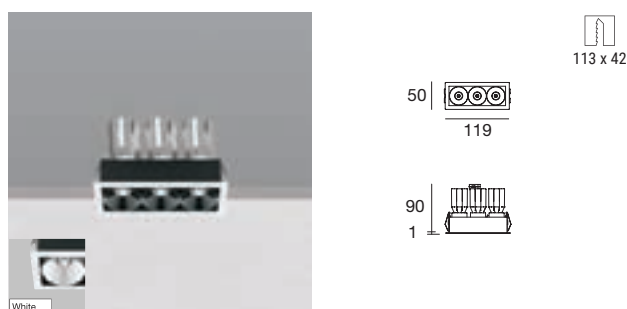
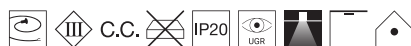

CRI 80

White	64509
Black	64510

	Cct	lm S - D CRI 80	Optic
M	2700	1470 - 1123	15 Spot (15°)
W	3000	1470 - 1123	30 Flood (34°)
N	4000	1587 - 1213	45 Flood (47°)

Électronique

99126	99115	99344
ON/OFF 1 art. p 134 x 137 x h 30	0/1-10V 1 art. p 210 x 148 x h 25	DALI 1 art. p 210 x 148 x h 25

Cell | Downlights | 6 x powerLEDs 2 W | 12 W DC 630 mA

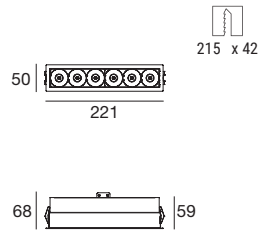

CRI 80/92

- White **64543**
- Black **64542**

	Cct	lm S - D CRI 80	lm S - D CRI 92	Optic
M	2700	-	942 - 852	15 Spot (12°)
W	3000	-	1074 - 907	30 Flood (32°)
N	4000	1494 - 965	-	45 Flood (49°)

Électronique

99129	99105	99115	99344
ON/OFF 1 art. p 134 x l 137 x h 31	ON/OFF 1 - 2 art. p 103 x l 58 x h 27	0/1-10V 1 art. p 210 x l 48 x h 25	DALI PUSH 1 - 2 art. p 210 x l 48 x h 25

Cell | Downlights | 9 x powerLEDs 2 W | 18 W DC 630 mA

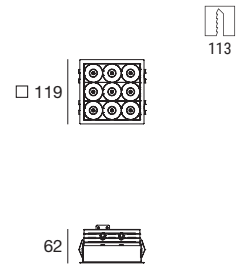

CRI 80/92

- White **64545**
- Black **64544**

	Cct	lm S - D CRI 80	lm S - D CRI 92	Optic
M	2700	-	1413 - 1342	15 Spot (11°)
W	3000	-	1611 - 1361	30 Flood (31°)
N	4000	2241 - 1448	-	45 Flood (49°)

Électronique

99105	99115	99344
ON/OFF 1 art. p 103 x l 58 x h 27	0/1-10V 1 art. p 210 x l 48 x h 28	DALI PUSH 1 art. p 210 x l 48 x h 28

64542W30

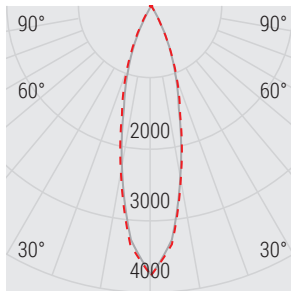

Courbe photométrique

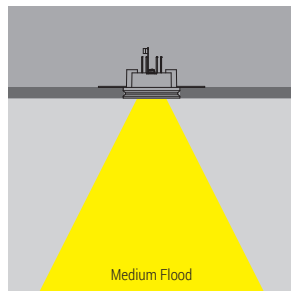

Faisceau lumineux

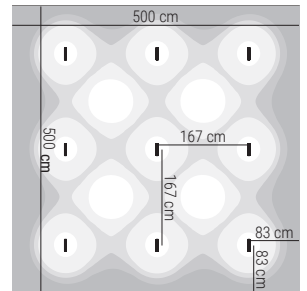
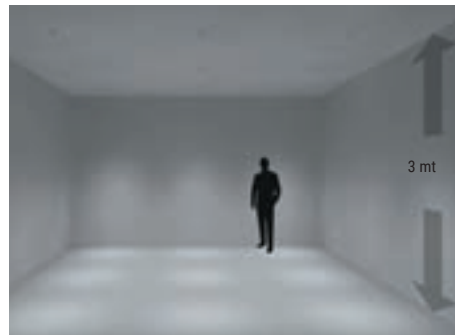

Planimétrie

64545W15

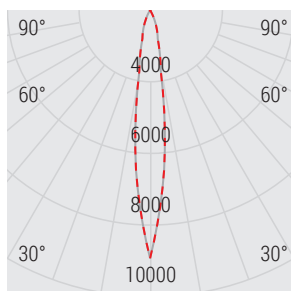

Courbe photométrique

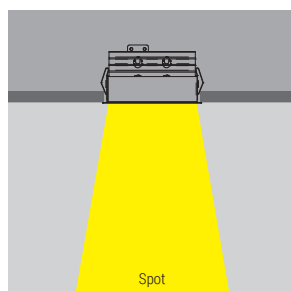

Faisceau lumineux

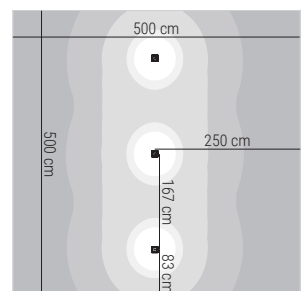
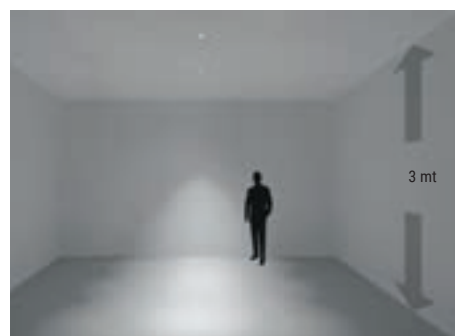

Planimétrie

Cell_Ww | Downlights | powerLED | 9,5 W DC 350 mA

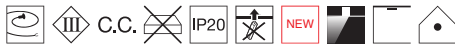

114 x 40

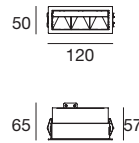

CRI 92

White	82600
Black	82940

	Cct	lm S - D CRI 92	Optic
M	2700	1099 - On req	07 Asymm. -
W	3000	1152 - On req	
N	4000	1426 - On req	

Électronique

99126	99115	99344
ON/OFF 1 art. p 206 x 189 x h 40	0/1-10V DALI PUSH 1 art. p 220 x 168 x h 39	0/1-10V DALI PUSH 1 art. p 220 x 168 x h 39

Cell_Ww | Downlights | powerLED | 18 W DC 630 mA



219 x 40

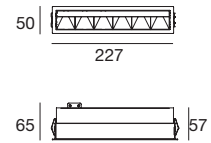

CRI 92

White	82601
Black	82941

	Cct	lm S - D CRI 92	Optic
M	2700	2198 - On req	07 Asymm. -
W	3000	2304 - On req	
N	4000	2852 - On req	

Électronique

99126	83008	99344
ON/OFF 1 art. p 206 x 189 x h 40	0/1-10V DALI PUSH 1 art. p 220 x 168 x h 39	0/1-10V DALI PUSH 1 art. p 220 x 168 x h 39

Cell_Ww | Downlights | powerLED | 32,5 W DC 1200 mA



432 x 42

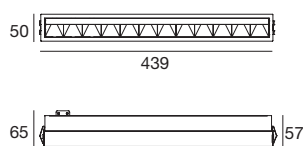

CRI 92

White	82602
Black	82942

	Cct	lm S - D CRI 92	Optic
M	2700	3740 - On req	07 Asymm. -
W	3000	3912 - On req	
N	4000	4848 - On req	

Électronique

83008
ON/OFF - 0/1-10V - DALI 1 art. p 206 x 189 x h 40

82600W07

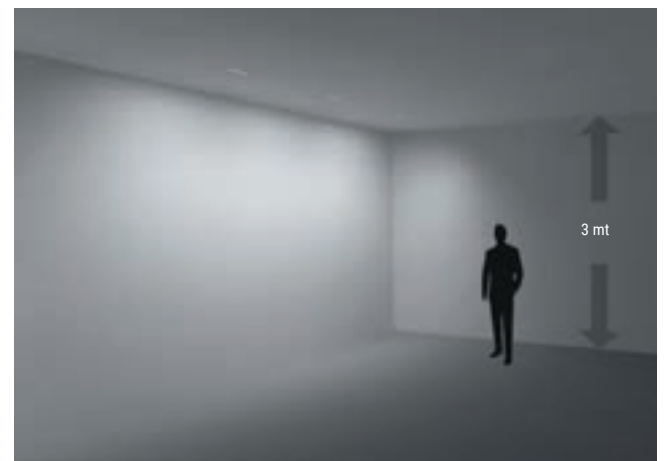
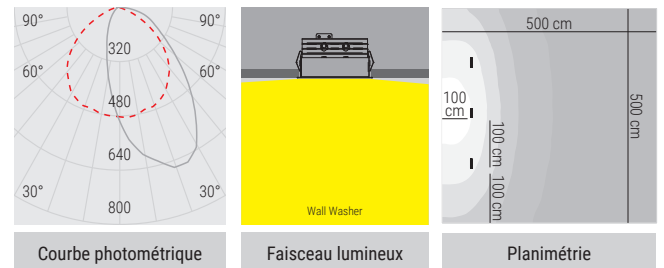





play

Matériaux

Boîtier d'encastrement en aluminium

Corps en aluminium



Play | Outer-casing (frameless)

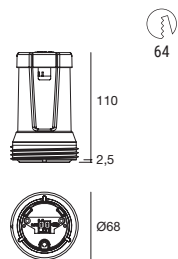

99754

Boîtier d'encastrement Play System affleurant avec filetage spécial à visser sur le bord du faux plafond.
Câblage du secondaire et support de montage inclus.

Play | Outer-casing (with frame)

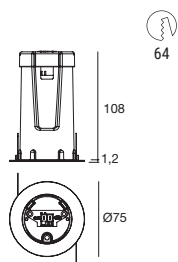
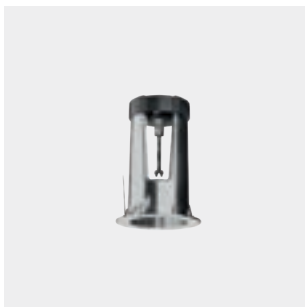

99752 White

99753 Black

Boîtier d'encastrement Play System avec bride à ressorts pour installation encastrée en butée sur le faux plafond. Câblage du secondaire inclus.

Play | Closing cap

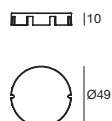

99755 White

99756 Black

Capuchon de fermeture du boîtier d'encastrement en cas d'absence d'article Play System.
Fixation mécanique seulement, pas de connexion électrique.

Play_Navata | Projector | powerLED 6 W DC 500 mA

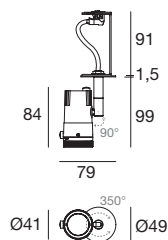
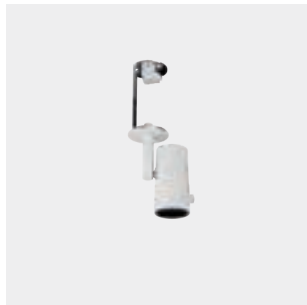

Balance - CRI 92 Efficiency - CRI 80

White	81528	81526
Black	81529	81527

Cct	lm S - D CRI 92	lm S - D CRI 80	Optic
M 2700	532 - On req	659 - On req	85 Adj. -
W 3000	569 - On req	659 - On req	
N 4000	614 - On req	712 - On req	

Électronique

99377	99106	99714	99715
ON/OFF 1 art. p 138 x l 22 x h 21	ON/OFF 2-3 art. p 103 x l 58 x h 27	0/1-10V 1 art. p 138 x l 22 x h 21	DALI 1 art. p 138 x l 22 x h 21

Play_Navata | Projector | powerLED 6 W DC 500 mA

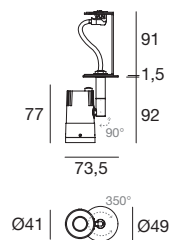
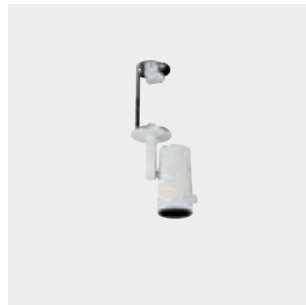

Balance - CRI 92 Efficiency - CRI 80

White	81532	81530
Black	81533	81531

Cct	lm S - D CRI 92	lm S - D CRI 80	Optic
M 2700	532 - 378	659 - 468	15 Spot -
W 3000	569 - 403	659 - 468	30 Flood -
N 4000	614 - 435	712 - 505	60 W.Flood -

Électronique

99377	99106	99714	99715
ON/OFF 1 art. p 138 x l 22 x h 21	ON/OFF 2-3 art. p 103 x l 58 x h 27	0/1-10V 1 art. p 138 x l 22 x h 21	DALI 1 art. p 138 x l 22 x h 21

Play_Quantum | Downlight | powerLED 6 W DC 500 mA

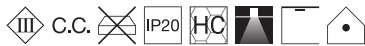

Balance - CRI 92 HC Efficiency - CRI 80 HC

White	81520	81552	81518	81550
Black	81521	81553	81519	81551

Cct	lm S - D CRI 92	lm S - D CRI 80	Optic
M 2700	532 - On req	659 - On req	15 Spot -
W 3000	569 - On req	659 - On req	30 Flood -
N 4000	614 - On req	712 - On req	60 W.Flood -

Électronique

99377	99106	99714	99715
ON/OFF 1 art. p 138 x l 22 x h 21	ON/OFF 2-3 art. p 103 x l 58 x h 27	0/1-10V 1 art. p 138 x l 22 x h 21	DALI 1 art. p 138 x l 22 x h 21

Play_S | Ceiling lamp | powerLED 6 W DC 500 mA

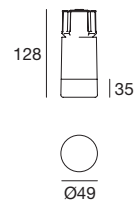

Balance - CRI 92

White	81522
-------	--------------

Cct	lm S - D CRI 92	Optic
M 2700	532 - On req	00 General -
W 3000	569 - On req	
N 4000	614 - On req	

Électronique

99377	99106	99714	99715
ON/OFF 1 art. p 138 x l 22 x h 21	ON/OFF 2-3 art. p 103 x l 58 x h 27	0/1-10V 1 art. p 138 x l 22 x h 21	DALI 1 art. p 138 x l 22 x h 21

Play_P | Pendant luminaire | powerLED 6 W DC 500 mA

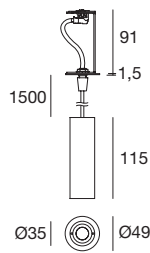

Balance - CRI 92 Efficiency - CRI 80

White	81536	81534
Black	81537	81535

Cct	lm S - D CRI 92	lm S - D CRI 80	Optic
M 2700	532 - On req	659 - On req	15 Spot -
W 3000	569 - On req	659 - On req	30 Flood -
N 4000	614 - On req	712 - On req	60 W.Flood -

Électronique

99377	99106	99714	99715
ON/OFF 1 art. p 138 x l 22 x h 21	ON/OFF 2-3 art. p 103 x l 58 x h 27	0/1-10V 1 art. p 138 x l 22 x h 21	DALI 1 art. p 138 x l 22 x h 21

Play_Giotto | Pendant luminaire | powerLED 6 W DC 500 mA

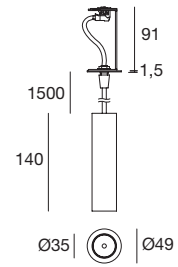

Balance - CRI 92 Efficiency - CRI 80

White	81540	81538
Black	81541	81539

Cct	lm S - D CRI 92	lm S - D CRI 80	Optic
M 2700	532 - 106	659 - 130	10 Spot -
W 3000	569 - 113	659 - 130	30 Flood -
N 4000	614 - 121	712 - 142	60 W.Flood -

Électronique

99377	99106	99714	99715
ON/OFF 1 art. p 138 x l 22 x h 21	ON/OFF 2-3 art. p 103 x l 58 x h 27	0/1-10V 1 art. p 138 x l 22 x h 21	DALI 1 art. p 138 x l 22 x h 21



optus_ex

Matériaux
Corps en aluminium



optus_EX range

Optus_T



Pag. 190

Optus_W



Pag. 196



	_EX mini Extractable mini	_EX Extractable
1,5 W	Ø 55 mm	-
4 W	Ø 75 mm	-
18 W	.	Ø 138 mm
34 W	.	Ø 173 mm
Accessories	-	
Finish	<input type="checkbox"/> White <input type="checkbox"/> Black	<input type="checkbox"/> White <input type="checkbox"/> Black
Specialty CRI 98	-	3000K
Fidelity CRI 98	-	3000K - 4000K
Balance CRI 92	-	2700K - 3000K - 4000K 5000K - Meat
DynamicWhite 2700K - 5700K	-	Ø 173 mm - Ø 138 mm
Optics	Spot - Flood - Wide Flood - Focus	Spot - Flood - Wide Flood
Driver	On/Off - 1-10 V - DALI	On/Off - 1-10 V - DALI
	46 mm - 66 mm	130 mm - 162 mm

Version orientable et extractible

Les downlights Optux_EX peuvent pivoter horizontalement à 350° et s'incliner par rapport à la verticale ; cette inclinaison permet un retrait du spot de 20° max ou une extraction jusqu'à 45°.

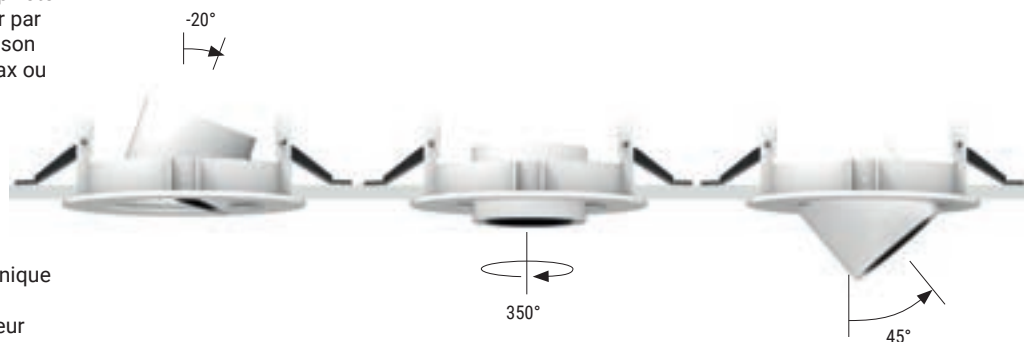

Faible encombrement

Optux_EX est composé d'un bloc unique d'aluminium moulé sous pression extrêmement compact, d'une hauteur de seulement 5 cm. Cette configuration particulière permet une installation sur des plaques de plâtre et des surfaces de faible hauteur et de faible marge de manœuvre.

Gamme de LED

La gamme Optux_EX offre le plus grand nombre de possibilités de combinaisons de sources ; elle peut être dotée des LED Balance - CRI 92, Specialty - CRI 98 et Fidelity - CRI 98. Elle permet ainsi une polyvalence maximale. Optux_EX peut en effet être utilisée dans de nombreux secteurs, tels que les musées et la vente au détail, en fonction du type de source choisi.



Accessoires pour le contrôle des faisceaux

Optux_EX est compatible avec une large gamme d'accessoires pour le contrôle de la lumière : masque diffuseur cylindrique standard et à 45°, pour supprimer tout ou partie du faisceau secondaire et réduire le cône lumineux ; déflecteur en croix et en nid d'abeille, pour contrôler et réduire l'éblouissement de forme plus ou moins marquée ; ailettes directionnelles et filtre elliptique, pour façonner la lumière ou créer des projections ovalisées.

Accessoire kicker

Appliqué à l'intérieur du trou d'installation, l'accessoire kicker permet de dissimuler la partie interne du faux plafond, autrement visible lorsque le spot est extrait et orienté.



Éclairage intelligent

Les modules Dynamic White, associés aux nouveaux systèmes de gestion spécifiquement développés, permettent de mélanger les nuances de blanc allant de Warm White à Cold White. Il est donc possible, avec un seul produit, de reproduire toutes les températures de couleur de 2700 K à 5700 K, en maintenant le même flux lumineux. Des études récentes sur les cycles circadiens ont démontré comment les variations de la température de la lumière naturelle, du lever au coucher du soleil, affectaient le bien-être des personnes.

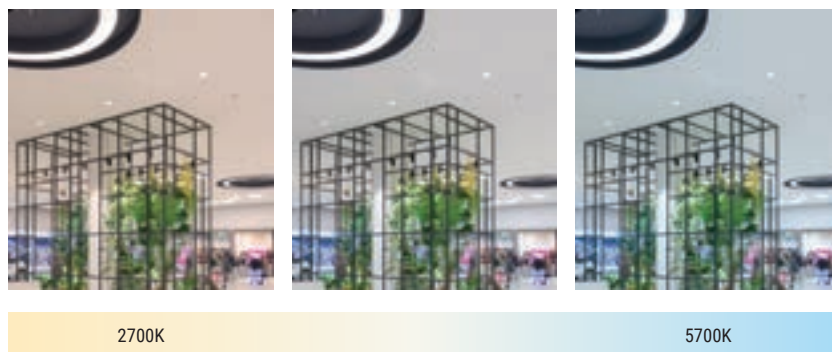

Optus_EX | Downlight | powerLED 1,5 W DC 500 mA

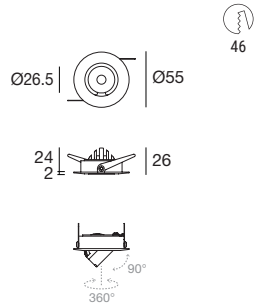

46

CRI 92	Cct	lm S - D	Optic
White 82737	M 2700	134 - 97	20 Spot (21°)
Black 82738	W 3000	153 - 111	35 Flood (32°)

99195	89146	99377	99709	99712	+ driver 24V DC
ON/OFF 1 - 2 art. p 138 x l 22 x h 21	ON/OFF 2 - 3 art. p 138 x l 22 x h 21	ON/OFF 3 - 6 art. p 138 x l 22 x h 21	24V DC converter 0/1-10V 1 art. p 138 x l 22 x h 21	24V DC converter DALI 1 art. p 138 x l 22 x h 21	99374 75W 99331 150W

Optus_EX | Downlight | powerLED 4 W DC 350mA

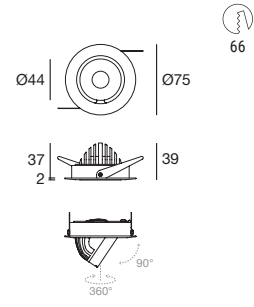

66

CRI 92	Cct	lm S - D	Optic
White 82739	M 2700	478 - 275	15 Spot (15°)
Black 82740	W 3000	514 - 295	30 Flood (33°)
	N 4000	551 - 318	60 W.Flood (61°)
			85 Focus -

89145	99375	99708	99711	+ driver 24V DC
ON/OFF 1 art. p 138 x l 22 x h 21	ON/OFF 2 - 3 art. p 138 x l 22 x h 21	0/1-10V converter 1 art. p 138 x l 22 x h 21	DALI converter 1 art. p 138 x l 22 x h 21	DC 99374 75W 99331 150W



85 Focus | 10° - 20°

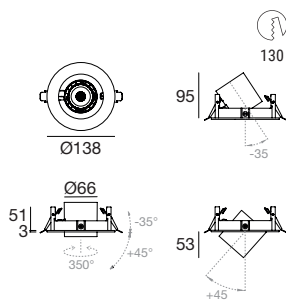

Specialty - CRI 98

White	81665
Black	81666

Cct	lm S - D CRI 98 12W	lm S - D CRI 98 18W	Optic
W 3000	1948 - 1445	1948 - 1445	15 Spot - 30 Flood - 60 W.Flood -

Fidelity - CRI 98

White	81663
Black	81664

Cct	lm S - D CRI 98 12W	lm S - D CRI 98 18W	Optic
W 3000	1948 - 1445	1948 - 1445	15 Spot -
N 4000	2141 - 1588	2141 - 1588	30 Flood - 60 W.Flood -

Balance - CRI 92

White	81661
Black	81662

Cct	lm S - D CRI 92 12W	lm S - D CRI 92 18W	Optic
W 3000	2224 - 1650	2224 - 1650	15 Spot -
N 4000	2390 - 1772	2390 - 1772	30 Flood - 60 W.Flood -

Électronique 12W DC 350mA

99126	99115	99344
ON/OFF 1 art. p 134 x l 37 x h 30	0/1-10V 1 art. p 210 x l 48 x h 25	DALI 1 art. p 210 x l 48 x h 25

Électronique 18W DC 500mA

99106	99115	99344
ON/OFF 1 art. p 103 x l 58 x h 27	0/1-10V 1 art. p 210 x l 48 x h 28	DALI PUSH 1 art. p 210 x l 48 x h 28

DW 15W DC 700mA

Dinamic White	
White	84159
Black	84160

D	2700K - 5700K	Dynamic White	Optic
			15 Spot - 30 Flood - 60 W.Flood -

Électronique

83159	99333	DMX	Driver CV
DALI DT8 1 - 2 art. p 270 x l 490 x h 225	Dimmer DMX 1 - 2 art.	Controllers Pag 952 - 953	CV 48V Pag 941

RTG 81661W30 / 81661W60 / 81662W30 / 81662W60 / 81661N60

Optiques & accessoires Pag. 148/149

Downlight

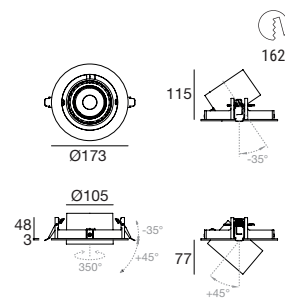

Specialty - CRI 98

White	81671
Black	81672

Cct	lm S - D CRI 98 25W	lm S - D CRI 98 35W	Optic
W 3000	3608 - 2925	3608 - 2925	15 Spot (17°) 30 Flood (26°) 60 W.Flood (51°)

Fidelity - CRI 98

White	81669
Black	81670

Cct	lm S - D CRI 98 25W	lm S - D CRI 98 35W	Optic
W 3000	3608 - 2925	3608 - 2925	15 Spot (17°)
N 4000	3964 - 3214	3964 - 3214	30 Flood (26°) 60 W.Flood (51°)

Balance - CRI 92

White	81667
Black	81668

Cct	lm S - D CRI 92 25W	lm S - D CRI 92 35W	Optic
M 2700	3930 - On req	3930 - On req	15 Spot (17°)
W 3000	4117 - 3338	4117 - 3338	30 Flood (26°)
N 4000	4426 - 3588	4426 - 3588	60 W.Flood (51°)
C 5000	4555 - 3693	4555 - 3693	
F 4000	2368 - 2222	2368 - 2222	

Électronique 25W DC 700mA

99147	83008	99345
ON/OFF 1 art. p 103 x l 58 x h 27	0/1-10V DALI PUSH 1 art. p 124 x l 67 x h 22	DALI PUSH 1 art. p 210 x l 48 x h 28

Électronique 35W DC 950mA

99239	83008	99345
ON/OFF 1 art. p 103 x l 58 x h 27	0/1-10V DALI PUSH 1 art. p 124 x l 67 x h 22	DALI PUSH 1 art. p 210 x l 48 x h 28

RTG 81667W30 / 81667W60 / 81668W30 / 81668W60 / 81667N30

Optiques & accessoires Pag. 148/149

Optus_EX | Downlight | arrayLED 15 W DC 950mA

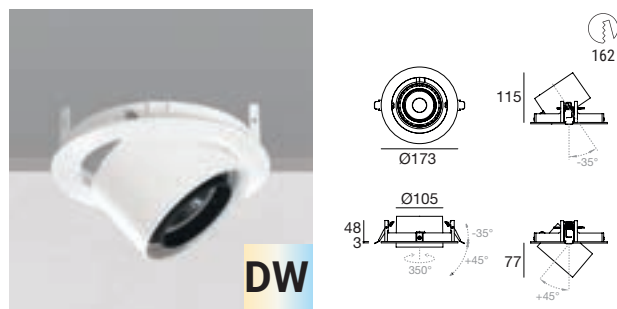

Dinamic White

White	84161
Black	84162

			Optic	
D	2700K - 5700K	Dynamic White	15	Spot -
			30	Flood -
			60	W.Flood -

Électronique

83159	99333	DMX	Driver CV
DALI DT8 1 - 2 art. p 270 x 1490 x h 225	Dimmer DMX 1 - 2 art.	Controllers Pag 952 - 953	CV 48V Pag 941

Optiques & accessoires Pag. 148/149

Optus_EX | Downlight | arrayLED 25 W DC 950mA

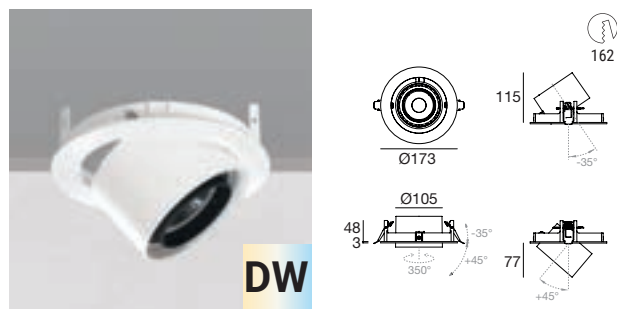

Dinamic White

White	84163
Black	84164

			Optic	
D	2700K - 5700K	Dynamic White	15	Spot -
			30	Flood -
			60	W.Flood -

Électronique

83159	99333	DMX	Driver CV
DALI DT8 1 art. p 270 x 1490 x h 225	Dimmer DMX 1 - 2 art.	Controllers Pag 952 - 953	CV 48V Pag 941

Optiques & accessoires Pag. 148/149

Optiques

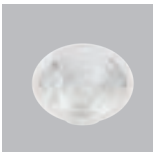
	description
	99827 Spot suitable for: Optus_EX 12W / 18W

	description
	99829 Wide Flood suitable for: Optus_EX 12W / 18W

	description
	99828 Flood suitable for: Optus_EX 12W / 18W

	description
	99844 Kit Focale suitable for: Optus_EX 12W / 18W

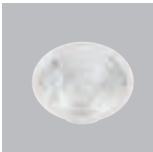
	description
	99808 Spot suitable for: Optus_EX 15W / 25W / 35W

	description
	99810 Wide Flood suitable for: Optus_EX 15W / 25W / 35W

	description
	99809 Flood suitable for: Optus_EX 15W / 25W / 35W

	description
	99843 Kit Focale suitable for: Optus_EX 15W / 25W / 35W

Accessoires



description	
99781	Filtre elliptique
suitable for: Optus_EX 12W / 18W	

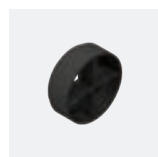

description	
99779	Défecteur en croix
suitable for: Optus_EX 12W / 18W	



description	
99782	Écran cylindrique 45°
suitable for: Optus_EX 12W / 18W	



description	
99510	Kicker
suitable for: Optus_EX 12W / 18W	

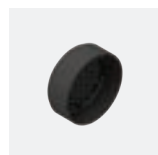

description	
99780	Honeycomb
suitable for: Optus_EX 12W / 18W	



description	
99783	Écran cylindrique
suitable for: Optus_EX 12W / 18W	

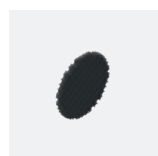

description	
99841	Honeycomb
suitable for: Focal kit 99844	



description	
99797	Filtre elliptique
suitable for: Optus_EX 15W / 25W / 35W	

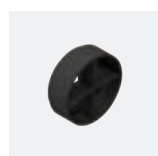

description	
99799	Défecteur en croix
suitable for: Optus_EX 15W / 25W / 35W	



description	
99795	Écran cylindrique 45°
suitable for: Optus_EX 15W / 25W / 35W	



description	
99479	Kicker
suitable for: Optus_EX 15W / 25W / 35W	

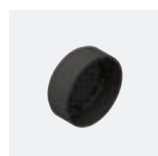

description	
99798	Honeycomb
suitable for: Optus_EX 15W / 25W / 35W	



description	
99796	Écran cylindrique
suitable for: Optus_EX 15W / 25W / 35W	

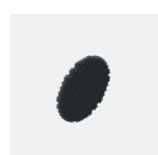

description	
99842	Honeycomb
suitable for: Focal kit 99843	



illuminator

Matériaux
Corps en aluminium



illuminator | Downlight | arrayLED 7 W DC 700 mA

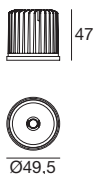

CRI 92

Anod. AL. **80338**

	Cct	lm S - D CRI 92	Optic
W	3000	665 - 602	15 Spot (15°)
N	4000	718 - 649	30 Flood (26°)
			60 W.Flood (52°)

Électronique

99735	99147	99733	99731	99345
ON/OFF 1 art. p 134 x 137 x h 31	ON/OFF 2 - 3 art. p 103 x 158 x h 27	0/1-10V 1 art. p 134 x 137 x h 31	DALI PUSH 1 art. p 134 x 137 x h 31	DALI PUSH 1 - 3 art. p 210 x 148 x h 25

illuminator | Boîtier d'encastrement orientable

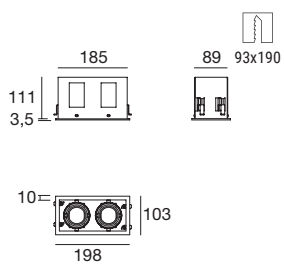
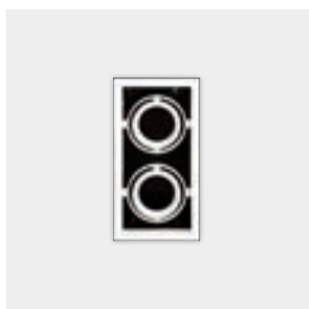

White	99486	2 x lamp
Black	99489	2 x lamp

Accessoires Pag. 157

- 99550** Honeycomb
- 99554** Écran cylindrique
- 99552** Filtre elliptique

RTG 99486

illuminator | Boîtier d'encastrement orientable

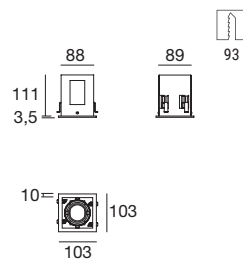
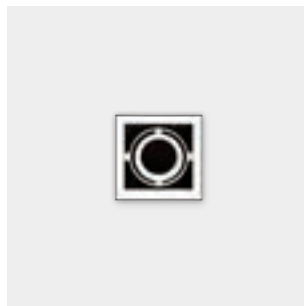

White	99485	1 x lamp
Black	99488	1 x lamp

Accessoires Pag. 157

- 99550** Honeycomb
- 99554** Écran cylindrique
- 99552** Filtre elliptique

RTG 99485

illuminator | Boîtier d'encastrement orientable

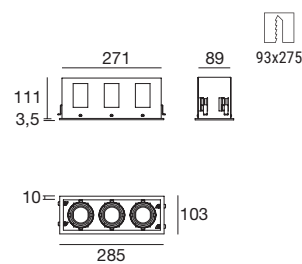
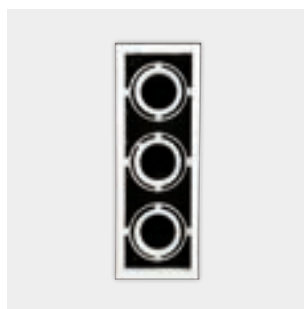

White	99487	3 x lamp
Black	99490	3 x lamp

Accessoires Pag. 157

- 99550** Honeycomb
- 99554** Écran cylindrique
- 99552** Filtre elliptique

RTG 99487

illuminator | Downlight | arrayLED 18 W DC 500 mA



CRI 92

White **82339**

Black **82340**

	Cct	lm S - D CRI 92	Optic
W	3000	2016 - On req	30 Flood -
N	4000	2170 - On req	60 W.Flood -

Électronique

99106	99115	99344
ON/OFF 1 art. p 103 x 158 x h 27	0/1-10V 1 art. p 210 x 148 x h 28	DALI PUSH 1 art. p 210 x 148 x h 28

illuminator | Boîtier d'encastrement orientable

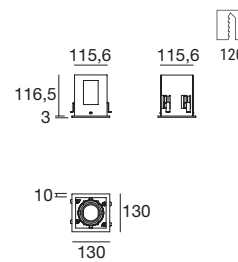
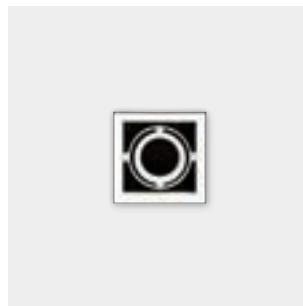

White **99491** 1 x lamp

Black **99494** 1 x lamp

Accessoires Pag. 157

- 99896** Honeycomb
- 99981** Écran cylindrique
- 99897** Filtre elliptique

RTG 99491

illuminator | Boîtier d'encastrement orientable

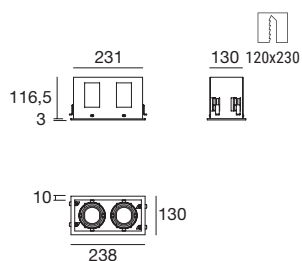

White **99492** 2 x lamp

Black **99495** 2 x lamp

Accessoires Pag. 157

- 99896** Honeycomb
- 99981** Écran cylindrique
- 99897** Filtre elliptique

RTG 99492

illuminator | Downlight | arrayLED 15 W DC 400 mA

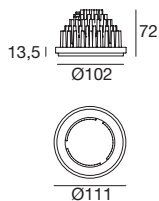

CRI 92

White	80389
Black	80390

Cct	lm S - D CRI 92	Optic
W 3000	1677 - 1468	30 Flood (25°)
N 4000	1804 - 1580	60 W.Flood (49°)

Électronique

99740	99739	99738
ON/OFF 1 art. p 134 x 137 x h 31	0/1-10V 1 art. p 134 x 137 x h 31	DALI PUSH 1 art. p 134 x 137 x h 31

Optiques Pag. 156/157

99562 Wide Flood	99561 Flood
-------------------------	--------------------

illuminator | Downlight | arrayLED 25 W DC 700 mA

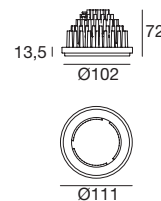

CRI 92

White	80387
Black	80388

Cct	lm S - D CRI 92	Optic
W 3000	2794 - 2288	30 Flood (24°)
N 4000	2990 - 2448	60 W.Flood (56°)

Électronique

99112	83066	99330
ON/OFF 1 art. p 103 x 158 x h 27	0/1-10V DALI PUSH 1 art. p 124 x 167 x h 22	DALI PUSH 1 art. p 210 x 148 x h 28

Optiques Pag. 156/157

99562 Wide Flood	99561 Flood
-------------------------	--------------------

illuminator | Downlight | arrayLED 30 W DC 840 mA



CRI 92

White	91229
Black	91230

Cct	lm S - D CRI 92	Optic
W 3000	3554 - 2810	15 Spot (15°)
N 4000	3806 - 3009	30 Flood (26°)
		60 W.Flood (57°)

Électronique

99093	83066	99330
ON/OFF 1 art. p 103 x 158 x h 27	0/1-10V DALI PUSH 1 art. p 124 x 167 x h 22	DALI PUSH 1 art. p 210 x 148 x h 28

Optiques Pag. 156/157

98507 Spot	98509 Wide Flood
98508 Flood	

illuminator | Downlight | arrayLED 35 W DC 950 mA

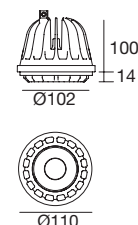

CRI 92

White	82341
Black	82342

Cct	lm S - D CRI 92	Optic
W 3000	3937 - On req	15 Spot -
N 4000	4232 - On req	30 Flood -
		60 W.Flood -

Électronique

99239	83008	99345
ON/OFF 1 art. p 103 x 158 x h 27	0/1-10V DALI PUSH 1 art. p 124 x 167 x h 22	DALI PUSH 1 art. p 210 x 148 x h 28

Optiques Pag. 156/157

98507 Spot	98509 Wide Flood
98508 Flood	

RTG 82341W30 / 82341W60

illuminator | Boîtier d'encastrement orientable

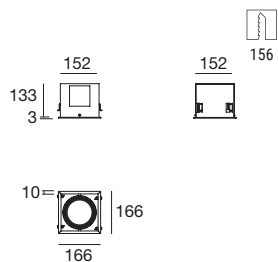
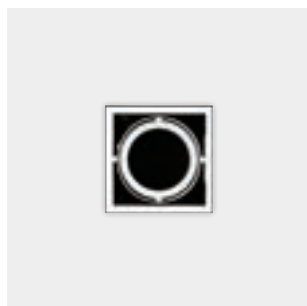

White	99497	1 x lamp
Black	99500	1 x lamp

Accessoires Pag. 157

- 99551** Honeycomb
- 99555** Écran cylindrique
- 99553** Filtre elliptique

Accessoires 35 W Pag. 157

- 99921** Honeycomb
- 99555** Écran cylindrique
- 99920** Filtre elliptique

RTG 99497

illuminator | Boîtier d'encastrement orientable

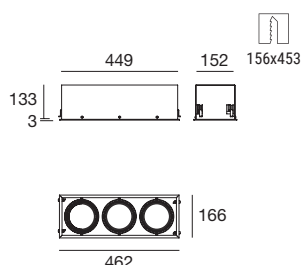

White	99499	3 x lamp
Black	99502	3 x lamp

Accessoires Pag. 157

- 99551** Honeycomb
- 99555** Écran cylindrique
- 99553** Filtre elliptique

Accessoires 35 W Pag. 157

- 99921** Honeycomb
- 99555** Écran cylindrique
- 99920** Filtre elliptique

RTG 99499

illuminator | Boîtier d'encastrement orientable

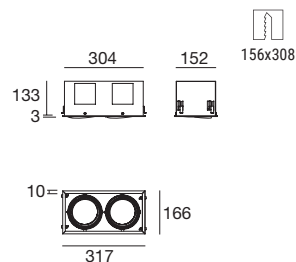

White	99498	2 x lamp
Black	99501	2 x lamp

Accessoires Pag. 157

- 99551** Honeycomb
- 99555** Écran cylindrique
- 99553** Filtre elliptique

Accessoires 35 W Pag. 157

- 99921** Honeycomb
- 99555** Écran cylindrique
- 99920** Filtre elliptique

RTG 99498

BOÎTIER D'ENCASTREMENT ORIENTABLE

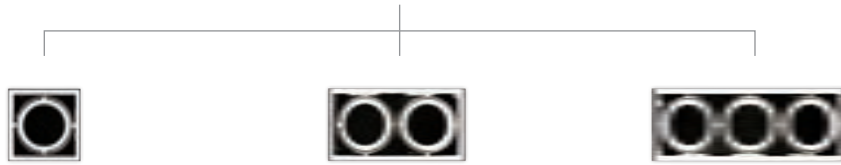

ÉLECTRONIQUE



LAMPE



Illuminator 7 W

Illuminator 18 W

Illuminator 15 W

Illuminator 25 W

Illuminator 30 W

Illuminator 35 W

ACCESSOIRES

Illuminator



Honeycomb



Écran cylindrique



Filtre elliptique

Optiques

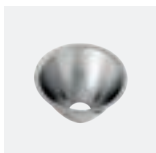

description

99561 Flood
suitable for: Illuminator 15W / Illuminator 25W

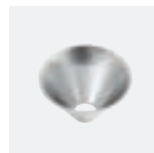

description

99562 Wide Flood
suitable for: Illuminator 15W / Illuminator 25W

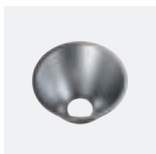

description

98507 Spot
suitable for: Illuminator 30W

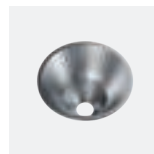

description

98508 Flood
suitable for: Illuminator 30W

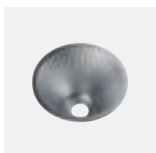

description

98509 Wide Flood
suitable for: Illuminator 30W

Optiques

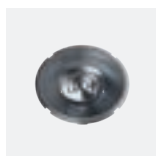

description	
99808	Spot
suitable for: Illuminator 35W	

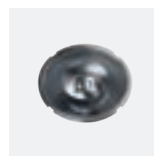

description	
99809	Flood
suitable for: Illuminator 35W	

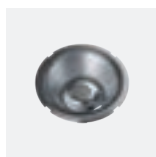

description	
99810	Wide Flood
suitable for: Illuminator 35W	

Accessoires

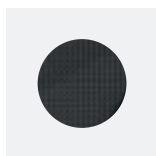

description	
99550	Honeycomb
suitable for: Illuminator 7W	



description	
99554	Écran cylindrique
suitable for: Illuminator 7W	

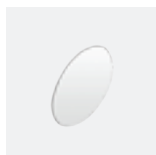

description	
99552	Filtre elliptique
suitable for: Illuminator 7W	

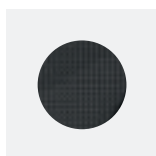

description	
99896	Honeycomb
suitable for: Illuminator 18W Illuminator outer casing	



description	
99981	Écran cylindrique
suitable for: Illuminator 18W Illuminator outer casing	

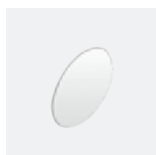

description	
99897	Filtre elliptique
suitable for: Illuminator 18W Illuminator outer casing	

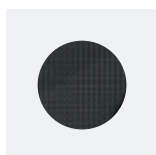

description	
99551	Honeycomb
suitable for: Illuminator 15W / 25W / 30W Illuminator outer casing	



description	
99555	Écran cylindrique
suitable for: Illuminator 15W / 25W / 30W / 35W Illuminator outer casing	

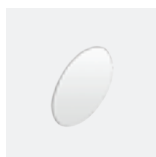

description	
99553	Filtre elliptique
suitable for: Illuminator 15W / 25W / 30W Illuminator outer casing	

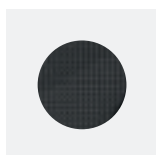

description	
99921	Honeycomb
suitable for: Illuminator 35W Illuminator outer casing	

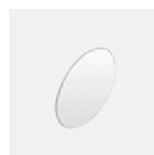















description	
99920	Filtre elliptique
suitable for: Illuminator 35W Illuminator outer casing	





Projectors

projectors range index

Pound	Pound_T  new 172	Pound_SuperSpot  new 172	Pound Focus  new 176	Pound Shaper  new 179	Pound_BC  new 182	Pound_BS  new 183
Optus	Optus_T  new 190	Optus_Ww  new 194	Optus_W  new 196			
Cell	Cell_Ww track  new 199					
Track system	Track system  202					
Navata	Navata Optus  new 210	Navata Pound Shaper  new 211				
Creek	Creek_Optus  new 219					







ACCESS
NYC
IN A
NEW YORK
MINUTE

JOSEPH

fitting room

DIANE VON
FURSTENBERG

projectors optics

Lentilles TIR

L'optique TIR (réflexion interne totale) est constituée de résines thermoplastiques ou de verre « optique ». Elle est utilisée pour réduire les faisceaux secondaires.

Le faisceau lumineux est collimaté en un point central caractérisé par un diamètre qui varie en fonction de la géométrie de l'optique, assurant ainsi précision et propreté lors de la projection.

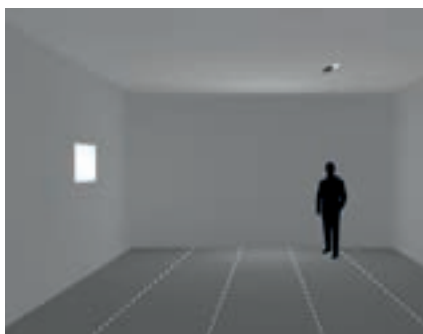

L'éclairage profilé au moyen du cadre Shaper a été pensé pour l'exposition. Le cadre transmet la lumière sur l'œuvre exposée, la mettant en valeur par rapport au reste de l'environnement. La bague permet d'ajuster la mise au point du faisceau, pour un éclairage doux ou plus défini. Le bouton rotatif externe permet quant à lui de régler l'extraction de la lentille et donc la concentration de lumière en un point spécifique. Il est, par conséquent, possible d'obtenir un éclairage idéal à toutes distances (ex. 1 et 4 mètres). Le positionnement des quatre lamelles en inox permet de varier la forme du faisceau lumineux.

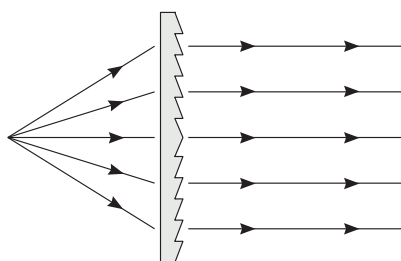
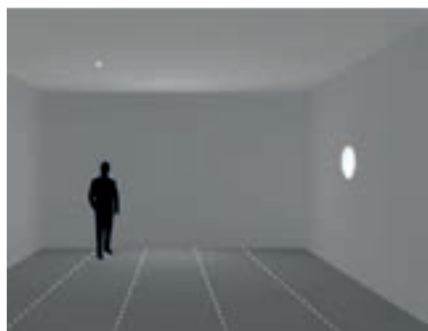

L'optique de Fresnel a été conçue dans le domaine de l'éclairage naval et s'utilise en photographie pour des prises de vues hautement professionnelles. Dotée d'une configuration particulière et caractéristique, la lentille de Fresnel permet de véhiculer la lumière en assurant un éclairage ponctuel et d'accentuation, y compris sur de longues distances.

Optique dynamique variable



Ce système optique particulier permet de faire varier l'angle de diffusion via l'adoption d'une lentille sphérique et de son mécanisme de coulissement interne. L'angle peut se régler via la bague dédiée intégrée sur le projecteur.

Optique à focale variable

projectors accessories

Optiques

● Optique dynamique variable



Un accessoire focal unique sur le marché, qui permet de régler la mise au point du faisceau lumineux et/ou le zoom à l'aide de deux bagues. L'installation plug and play permet d'obtenir une lumière dynamique et polyvalente en toutes situations.

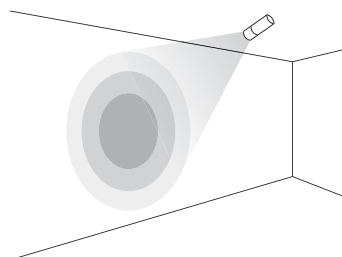

Flap

✦ Ailettes directionnelles



Cet outil de mise en forme de la lumière permet de contrôler la diffusion de celle-ci. Les quatre volets peuvent être ajustés individuellement pour permettre de contrôler et donner forme au faisceau lumineux émis.

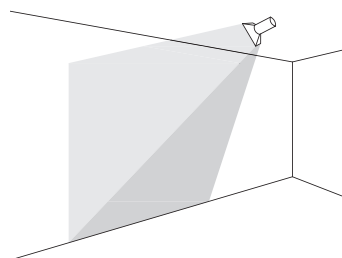

Défecteur

● Honeycomb



La grille en nid d'abeilles réduit l'éblouissement dans la direction perpendiculaire au flux lumineux. Les cellules contribuent à l'orientation de la lumière vers un point déterminé, générant ainsi des ombres douces. L'application de cet accessoire peut entraîner une réduction du flux lumineux d'environ 20 à 30 %.



⊕ Défecteur en croix



Accessoire servant à contenir le faisceau lumineux, augmentant ainsi le confort visuel pour les applications au plafond avec émission perpendiculaire au sol. L'application du déflecteur entraîne une réduction d'environ 10 % du flux lumineux en sortie et des ombres plus nettes par rapport au déflecteur en nid d'abeilles.

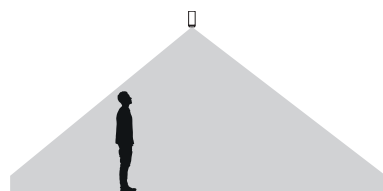

Écrans

▀ Écran asymétrique à 45 ° avec mouvement de rotation (« visière »)



Cet accessoire modifie partiellement le faisceau lumineux, tout en réduisant la dispersion du faisceau secondaire sur environ la moitié de la zone d'émission.

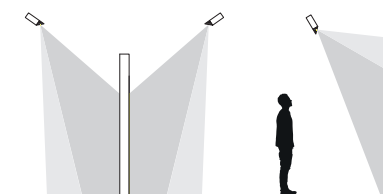

■ Écran cylindrique



L'écran cylindrique élimine complètement les faisceaux secondaires, ce qui réduit considérablement le phénomène d'éblouissement. Il s'utilise pour valoriser les détails.

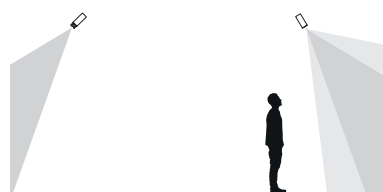



pound

Matériaux
Corps en aluminium



Gamme de LED



La nouvelle famille Pound présente trois nouveautés pour l'installation sur rail et six nouveautés pour palier aux différentes exigences d'installations ne permettant pas d'utiliser un rail. Les nouveaux projecteurs installés sur rail utilisent les technologies suivantes : Focus on Board, Shaper et Super Spot, parfaites pour répondre aux innombrables exigences requises dans les boutiques et les musées. Là où il n'est pas possible d'utiliser un rail, la famille Pound propose de nombreuses variantes comme Pound_BC, Pound_BS et Pound_S qui peuvent être installées dans différentes positions. La dernière nouveauté concerne les Pound_Wall, conçus pour s'adapter à toutes situations grâce à leur nouvelle articulation qui permet d'orienter le produit sur un axe vertical de 90 ° et sur un axe horizontal de 350 °.

Pound Super spot

Pound met à disposition une version spéciale avec un faisceau extrêmement serré (8). La lentille de Fresnel permet à Pound d'atteindre de petits objets ou de mettre en évidence des détails dans les salles des musées ou dans les boutiques.

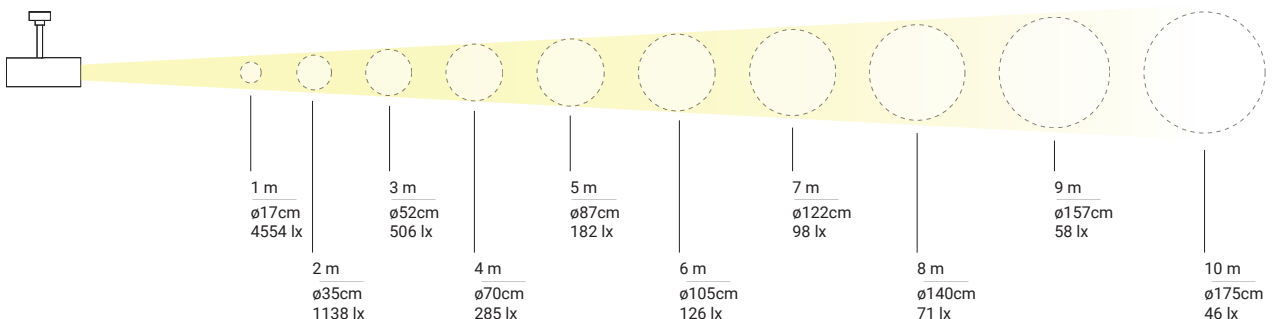
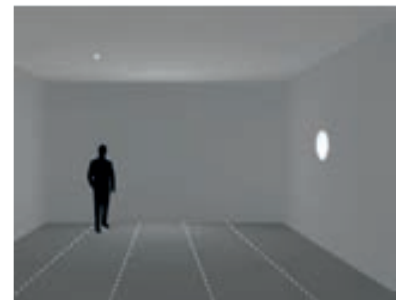
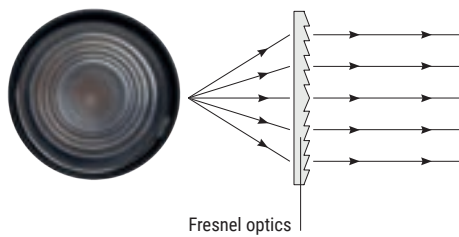

Pound Shaper

Pound Shaper est le nouveau cadreur professionnel de la gamme des projecteurs à Led.

Il permet de mettre en valeur les œuvres d'art de différentes formes et dimensions conservées dans les musées avec un Snoot qui réduit totalement la projection des reflets provenant du compartiment optique.

Facile à utiliser, disponible en 2 puissances, 11 et 27 watts, et deux objectifs différents pouvant s'adapter à toutes les distances.



Acro Optic Technology®



Conventional Optic Shaper

Rapport de profilage

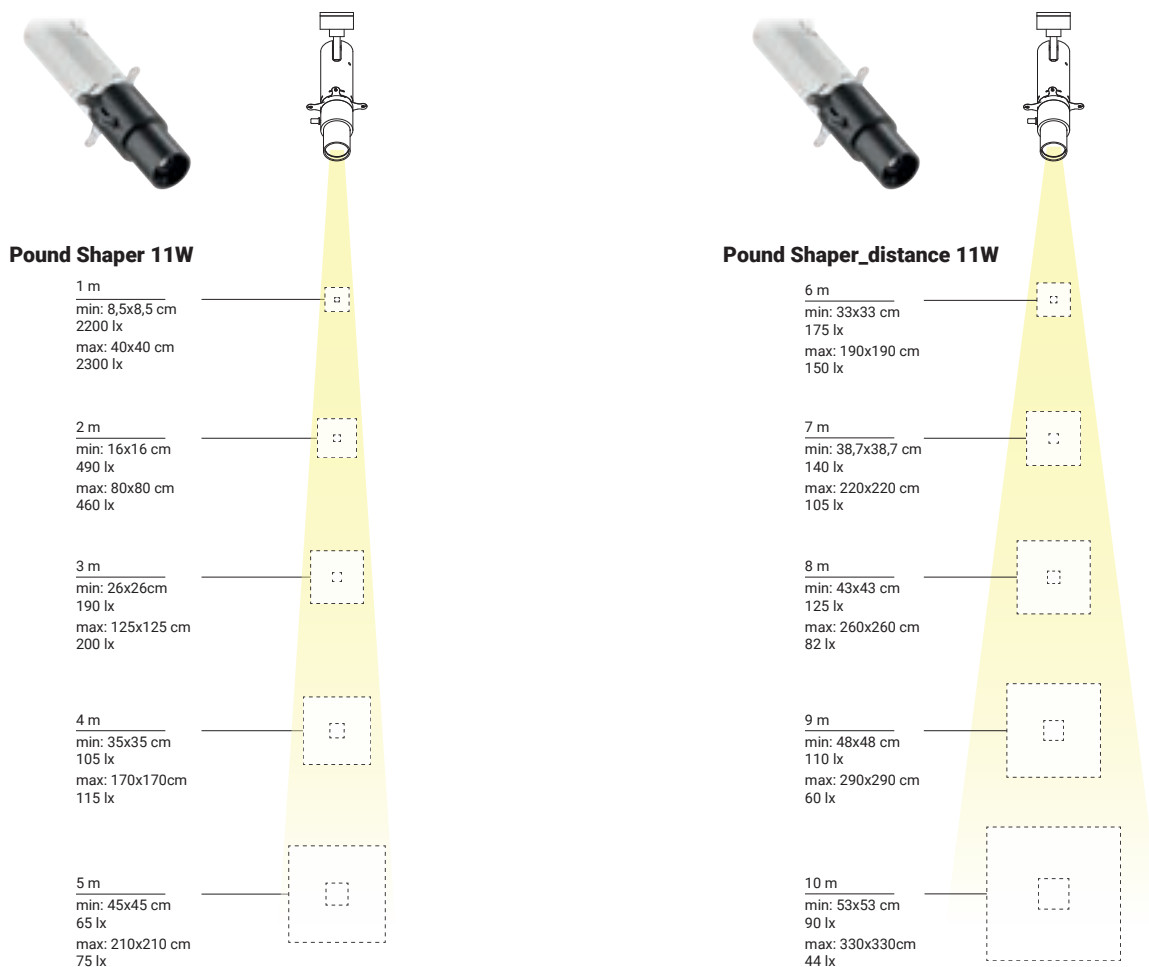

pound range



	Pag. 273 Pound_Wall	Pag. 273 Pound_Wall Focus	Pag. 272 Pound_S	Pag. 272 Pound_S Focus	Pound_BC
6W	Ø 48 mm	Ø 48 mm	Ø 48 mm	Ø 48 mm	-
7,2W	-	-	-	-	-
11W	-	-	-	-	-
13W	-	-	-	-	Ø 48 mm
18W	Ø 65 mm	Ø 65 mm	Ø 65 mm	Ø 65 mm	-
23W	-	-	-	-	-
24,5W	-	Ø 85mm	-	Ø 85mm	-
25W - 25,5W	Ø 85mm	-	Ø 85mm	-	Ø 65 mm
27W	-	-	-	-	-
32,5W	-	-	-	-	-
34W	-	-	-	-	Ø 85mm
Finish	<input type="checkbox"/> White <input checked="" type="checkbox"/> Black	<input type="checkbox"/> White <input checked="" type="checkbox"/> Black	<input type="checkbox"/> White <input checked="" type="checkbox"/> Black	<input type="checkbox"/> White <input checked="" type="checkbox"/> Black	<input type="checkbox"/> White <input checked="" type="checkbox"/> Black
Specialty CRI 98	-	-	-	-	-
Fidelity CRI 98	-	-	-	-	-
Balance CRI 92	2700 K - 3000 K 4000 K	2700 K - 3000 K 4000 K	2700 K - 3000 K 4000 K	2700 K - 3000 K 4000 K	2700 K - 3000 K 4000 K
Optics	Spot - Flood - W.Flood	Focus	Spot - Flood - W.Flood	Focus	Spot - Flood - W.Flood
Accessories		-		-	
Control	On-Off	On-Off	On-Off	On-Off	.



	Pound_BS	Pound_T	Pound Focus	Pound Shaper	Pound_T Super Spot
6W	-	-	-	-	-
7,2W	-	-	-	-	Ø 48 mm
11W	-	-	-	Ø 40 mm - Ø 44 mm	-
13W	Ø 48 mm	Ø 48 mm	Ø 48 mm	-	-
18W	-	-	-	-	-
23W	-	-	Ø 65 mm	-	-
24,5W	-	-	-	-	-
25W - 25,5W	Ø 65 mm	Ø 65 mm	-	-	-
27W	-	-	-	Ø 63 mm - Ø 85 mm	-
32,5W	-	-	Ø 85mm	-	-
34W	Ø 85mm	Ø 85mm	-	-	-
Finish	<input type="checkbox"/> White <input checked="" type="checkbox"/> Black	<input type="checkbox"/> White <input checked="" type="checkbox"/> Black	<input type="checkbox"/> White <input checked="" type="checkbox"/> Black	<input type="checkbox"/> White <input checked="" type="checkbox"/> Black	<input type="checkbox"/> White <input checked="" type="checkbox"/> Black
Specialty CRI 98	-	3000 K	-	-	-
Fidelity CRI 98	-	2700 K - 3000 K 4000 K	2700 K - 3000 K 4000 K	2700 K - 3000 K 4000 K	-
Balance CRI 92	2700 K - 3000 K 4000 K	3000 K - 4000 K	2700 K - 3000 K 4000 K	-	2700 K - 3000 K 4000 K
Optics	Spot - Flood - W.Flood	Spot - Flood - W.Flood	Focus	Shaper	Super Spot
Accessories			-		-
Control	On-Off / DALI 2	On-Off / DALI 2 / D.O.B Bluetooth	DALI 2 / D.O.B. Bluetooth	DALI 2 / D.O.B. Bluetooth	DALI 2

Pound_T | Projectors | 176-264 V AC | arrayLED 13 W DC - 15,5 W AC

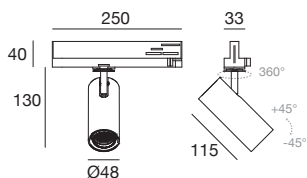

Specialty - CRI 98		Cct	lm S - D CRI 98	Optic
White	81629	W 3000	1142 - 936	15 Spot (17°)
Black	81630			30 Flood (25°)
				60 W.Flood (41°)

Fidelity - CRI 98		Cct	lm S - D CRI 98	Optic
White	81627	M 2700	1142 - 887	15 Spot (17°)
Black	81628	W 3000	1230 - 936	30 Flood (25°)
		N 4000	1318 - 1029	60 W.Flood (41°)

Balance - CRI 92		Cct	lm S - D CRI 92	Optic
White	81625	W 3000	1318 - 1062	15 Spot (17°)
Black	81626	N 4000	1515 - 1142	30 Flood (25°)
				60 W.Flood (41°)

Optiques & accessoires Pag. 184/185

Pound_T | Projectors | 176-264 V AC | arrayLED 25 W DC - 29 W AC

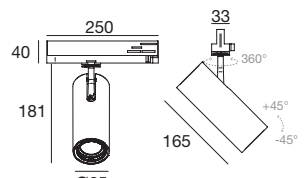

Specialty - CRI 98		Cct	lm S - D CRI 98	Optic
White	81635	W 3000	2577 - 1835	15 Spot (19°)
Black	81636			30 Flood (37°)
				60 W.Flood (63°)

Fidelity - CRI 98		Cct	lm S - D CRI 98	Optic
White	81633	M 2700	2440 - 1738	15 Spot (19°)
Black	81634	W 3000	2577 - 1835	30 Flood (37°)
		N 4000	2831 - 2016	60 W.Flood (63°)

Balance - CRI 92		Cct	lm S - D CRI 92	Optic
White	81631	W 3000	2941 - 2094	15 Spot (19°)
Black	81632	N 4000	3161 - 2251	30 Flood (37°)
				60 W.Flood (63°)

DW NEW

CRI 90		Dynamic White	Optic
White	84165	D 2700K - 5700K	15 Spot (19°)
Black	84166		30 Flood (37°)
			60 W.Flood (63°)

Optiques & accessoires Pag. 184/185

Pound_T Super Spot | Projectors | 176-264 V AC | powerLED 7,2 W DC - 9 W AC

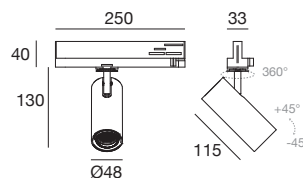

Balance - CRI 92		Cct	lm S - D CRI 92	Optic
White	81954	M 2700	614 - On req	08 Fresnel -
Black	81955	W 3000	657 - On req	
		N 4000	709 - On req	

Pound_T | Projectors | 176-264 V AC | arrayLED 34 W DC - 39 W AC

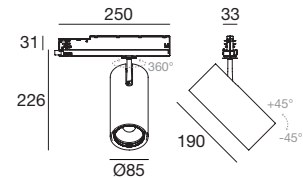

Specialty - CRI 98		Cct	lm S - D CRI 98	Optic
White	81641	W 3000	3608 - 2876	15 Spot (17°)
Black	81642			30 Flood (26°)
				60 W.Flood (57°)

Fidelity - CRI 98		Cct	lm S - D CRI 98	Optic
White	81639	M 2700	3416 - 2722	15 Spot (17°)
Black	81640	W 3000	3608 - 2876	30 Flood (26°)
		N 4000	3964 - 3160	60 W.Flood (57°)

Balance - CRI 92		Cct	lm S - D CRI 92	Optic
White	81637	W 3000	4117 - 3282	15 Spot (17°)
Black	81638	N 4000	4426 - 3528	30 Flood (26°)
				60 W.Flood (57°)

DW NEW

CRI 90		Dynamic White	Optic
White	84167	D 2700K - 5700K	15 Spot (17°)
Black	84168		30 Flood (26°)
			60 W.Flood (57°)

Optiques & accessoires Pag. 184/185

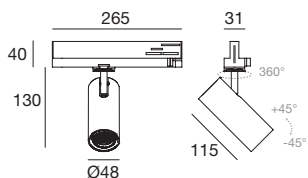

Specialty - CRI 98		Cct	lm S - D CRI 98	Optic
White	82611	W 3000	1142 - On req	15 Spot -
Black	82612			30 Flood -
				60 W.Flood -

Fidelity - CRI 98		Cct	lm S - D CRI 98	Optic
White	82609	M 2700	1142 - On req	15 Spot -
Black	82610	W 3000	1230 - On req	30 Flood -
		N 4000	1318 - On req	60 W.Flood -

Balance - CRI 92		Cct	lm S - D CRI 92	Optic
White	82607	W 3000	1318 - On req	15 Spot -
Black	82608	N 4000	1515 - On req	30 Flood -
				60 W.Flood -

Optiques & accessoires Pag. 184/185

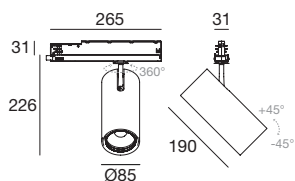

Specialty - CRI 98		Cct	lm S - D CRI 98	Optic
White	81756	W 3000	3289 - 2622	15 Spot (17°)
Black	81757			30 Flood (26°)
				60 W.Flood (57°)

Fidelity - CRI 98		Cct	lm S - D CRI 98	Optic
White	81754	M 2700	3114 - 2483	15 Spot (17°)
Black	81755	W 3000	3289 - 2622	30 Flood (26°)
		N 4000	3613 - 2882	60 W.Flood (57°)

Balance - CRI 92		Cct	lm S - D CRI 92	Optic
White	81752	W 3000	3753 - 2992	15 Spot (17°)
Black	81753	N 4000	4034 - 3219	30 Flood (26°)
				60 W.Flood (57°)

Optiques & accessoires Pag. 184/185

Projectors

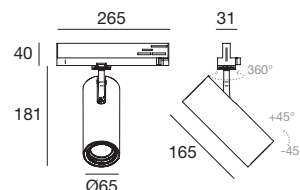

Specialty - CRI 98		Cct	lm S - D CRI 98	Optic
White	81812	W 3000	2427 - 1729	15 Spot (19°)
Black	81813			30 Flood (37°)
				60 W.Flood (63°)

Fidelity - CRI 98		Cct	lm S - D CRI 98	Optic
White	81810	M 2700	2298 - 1637	15 Spot (19°)
Black	81811	W 3000	2427 - 1729	30 Flood (37°)
		N 4000	2667 - 1899	60 W.Flood (63°)

Balance - CRI 92		Cct	lm S - D CRI 92	Optic
White	81808	W 3000	2770 - 1973	15 Spot (19°)
Black	81809	N 4000	2978 - 2120	30 Flood (37°)
				60 W.Flood (63°)

Optiques & accessoires Pag. 184/185

Pag. 172

RTG 81625W30 / 81625W60 / 81626W30 / 81626W60 / 81625N30

RTG 81631W30 / 81631W60 / 81632W30 / 81632W60

RTG 81637W30 / 81637W60 / 81638W30 / 81638W60 / 81637N30 / 81638N30



Technology Partner
SILVAIR

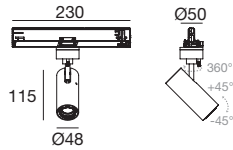

Specialty - CRI 98		Cct	lm S - D CRI 98	Optic
White	83799	W 3000	1213 - On req	15 Spot -
Black	83800			30 Flood -
				60 W.Flood -

Fidelity - CRI 98		Cct	lm S - D CRI 98	Optic
White	83801	M 2700	1148 - On req	15 Spot -
Black	83802	W 3000	1213 - On req	30 Flood -
		N 4000	1333 - On req	60 W.Flood -

Balance - CRI 92		Cct	lm S - D CRI 92	Optic
White	83803	M 2700	1314 - On req	15 Spot -
Black	83804	W 3000	1376 - On req	30 Flood -
		N 4000	1480 - On req	60 W.Flood -

Optiques & accessoires Pag. 184/185



Technology Partner
SILVAIR

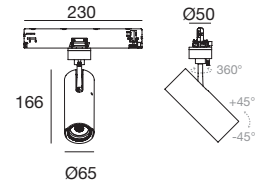

Specialty - CRI 98		Cct	lm S - D CRI 98	Optic
White	83805	W 3000	2273 - On req	15 Spot -
Black	83806			30 Flood -
				60 W.Flood -

Fidelity - CRI 98		Cct	lm S - D CRI 98	Optic
White	83807	M 2700	2152 - On req	15 Spot -
Black	83808	W 3000	2273 - On req	30 Flood -
		N 4000	2497 - On req	60 W.Flood -

Balance - CRI 92		Cct	lm S - D CRI 92	Optic
White	83809	M 2700	2477 - On req	15 Spot -
Black	83810	W 3000	2594 - On req	30 Flood -
		N 4000	2788 - On req	60 W.Flood -

Optiques & accessoires Pag. 184/185



Technology Partner
SILVAIR

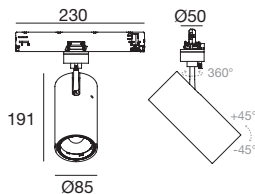

Specialty - CRI 98		Cct	lm S - D CRI 98	Optic
White	83811	W 3000	3450 - On req	15 Spot -
Black	83812			30 Flood -
				60 W.Flood -

Fidelity - CRI 98		Cct	lm S - D CRI 98	Optic
White	83823	M 2700	3266 - On req	15 Spot -
Black	83824	W 3000	3450 - On req	30 Flood -
		N 4000	3790 - On req	60 W.Flood -

Balance - CRI 92		Cct	lm S - D CRI 92	Optic
White	83825	M 2700	3758 - On req	15 Spot -
Black	83826	W 3000	3937 - On req	30 Flood -
		N 4000	4232 - On req	60 W.Flood -

Optiques & accessoires Pag. 184/185

Pound_T | Projectors | 198-264 V AC | arrayLED 13 W DC - 15,5 W AC

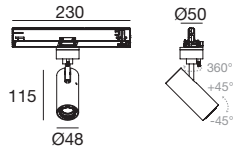

Specialty - CRI 98		Cct	lm S - D CRI 98	Optic
White	82408	W 3000	1213 - On req	15 Spot -
Black	82409			30 Flood -
				60 W.Flood -

Fidelity - CRI 98		Cct	lm S - D CRI 98	Optic
White	82406	M 2700	1148 - On req	15 Spot -
Black	82407	W 3000	1213 - On req	30 Flood -
		N 4000	1333 - On req	60 W.Flood -

Balance - CRI 92		Cct	lm S - D CRI 92	Optic
White	82227	M 2700	1314 - On req	15 Spot -
Black	82228	W 3000	1376 - On req	30 Flood -
		N 4000	1480 - On req	60 W.Flood -

Optiques & accessoires Pag. 184/185

Pound_T | Projectors | 198-264 V AC | arrayLED 23 W DC - 26 W AC

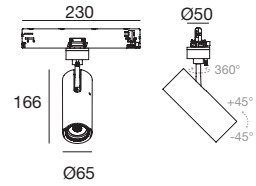

Specialty - CRI 98		Cct	lm S - D CRI 98	Optic
White	82412	W 3000	2273 - On req	15 Spot -
Black	82413			30 Flood -
				60 W.Flood -

Fidelity - CRI 98		Cct	lm S - D CRI 98	Optic
White	82410	M 2700	2152 - On req	15 Spot -
Black	82411	W 3000	2273 - On req	30 Flood -
		N 4000	2497 - On req	60 W.Flood -

Balance - CRI 92		Cct	lm S - D CRI 92	Optic
White	82229	M 2700	2477 - On req	15 Spot -
Black	82230	W 3000	2594 - On req	30 Flood -
		N 4000	2788 - On req	60 W.Flood -

Optiques & accessoires Pag. 184/185

Pound_T | Projectors | 198-264 V AC | arrayLED 32,5 W DC - 37,5 W AC

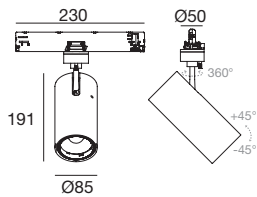

Specialty - CRI 98		Cct	lm S - D CRI 98	Optic
White	82416	W 3000	3450 On req	15 Spot -
Black	82417			30 Flood -
				60 W.Flood -

Fidelity - CRI 98		Cct	lm S - D CRI 98	Optic
White	82414	M 2700	3266 On req	15 Spot -
Black	82415	W 3000	3450 On req	30 Flood -
		N 4000	3790 On req	60 W.Flood -

Balance - CRI 92		Cct	lm S - D CRI 92	Optic
White	82231	M 2700	3758 On req	15 Spot -
Black	82232	W 3000	3937 On req	30 Flood -
		N 4000	4232 On req	60 W.Flood -

Optiques & accessoires Pag. 184/185

Pound Focus | Projectors | 176-264 V AC | arrayLED 13 W DC - 15,5 W AC

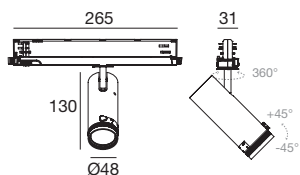

Fidelity - CRI 98		Cct	lm S - D CRI 98	Optic
White	82422	M 2700	1019 - On req	85 14° - 47°
Black	82423	W 3000	1076 - On req	
		N 4000	1182 - On req	

Balance - CRI 92		Cct	lm S - D CRI 92	Optic
White	81987	M 2700	1165 - On req	85 14° - 47°
Black	81988	W 3000	1220 - On req	
		N 4000	1311 - On req	

Pound Focus | Projectors | 176-264 V AC | arrayLED 23 W DC - 29 W AC

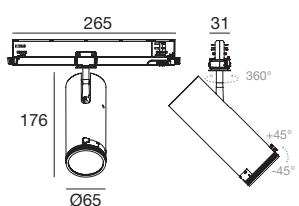

Fidelity - CRI 98		Cct	lm S - D CRI 98	Optic
White	82438	M 2700	2298 - On req	85 16° - 65°
Black	82439	W 3000	2427 - On req	
		N 4000	2667 - On req	

Balance - CRI 92		Cct	lm S - D CRI 92	Optic
White	81989	M 2700	2645 - On req	85 16° - 65°
Black	81990	W 3000	2770 - On req	
		N 4000	2978 - On req	

Pound Focus | Projectors | 176-264 V AC | arrayLED 32,5 W DC - 37 W AC

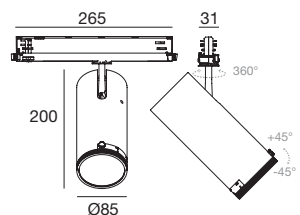

Fidelity - CRI 98		Cct	lm S - D CRI 98	Optic
White	82440	M 2700	3266 - On req	85 17° - 60°
Black	82441	W 3000	3450 - On req	
		N 4000	3790 - On req	

Balance - CRI 92		Cct	lm S - D CRI 92	Optic
White	81991	M 2700	3758 - On req	85 17° - 60°
Black	81992	W 3000	3937 - On req	
		N 4000	4232 - On req	

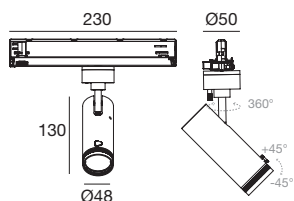

Fidelity - CRI 98		Cct	lm S - D CRI 98	Optic
White	83827	M 2700	1019 - On req	85 14° - 47°
Black	83828	W 3000	1076 - On req	
		N 4000	1182 - On req	

Balance - CRI 92		Cct	lm S - D CRI 92	Optic
White	83829	M 2700	1165 - On req	85 14° - 47°
Black	83830	W 3000	1220 - On req	
		N 4000	1311 - On req	

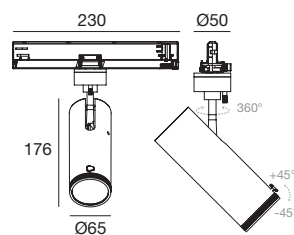

Fidelity - CRI 98		Cct	lm S - D CRI 98	Optic
White	83831	M 2700	2298 - On req	85 16° - 65°
Black	83832	W 3000	2427 - On req	
		N 4000	2667 - On req	

Balance - CRI 92		Cct	lm S - D CRI 92	Optic
White	83833	M 2700	2645 - On req	85 16° - 65°
Black	83834	W 3000	2770 - On req	
		N 4000	2978 - On req	

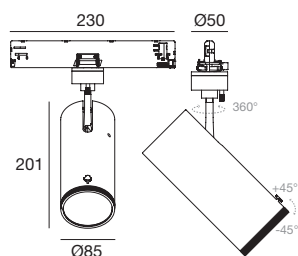

Fidelity - CRI 98		Cct	lm S - D CRI 98	Optic
White	83835	M 2700	3266 - On req	85 17° - 60°
Black	83836	W 3000	3450 - On req	
		N 4000	3790 - On req	

Balance - CRI 92		Cct	lm S - D CRI 92	Optic
White	83839	M 2700	3758 - On req	85 17° - 60°
Black	83840	W 3000	3937 - On req	
		N 4000	4232 - On req	

Pound Focus | Projectors | 198-264 V AC | arrayLED 13 W DC - 15,5 W AC

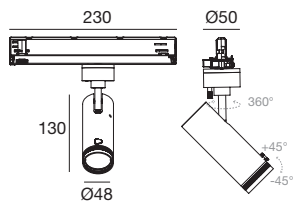

Fidelity - CRI 98		Cct	lm S - D CRI 98	Optic
White	82444	M 2700	1019 - On req	85 14° - 47°
Black	82445	W 3000	1076 - On req	
		N 4000	1182 - On req	

Balance - CRI 92		Cct	lm S - D CRI 92	Optic
White	82105	M 2700	1165 - On req	85 14° - 47°
Black	82106	W 3000	1220 - On req	
		N 4000	1311 - On req	

Pound Focus | Projectors | 198-264 V AC | arrayLED 23 W DC - 29 W AC

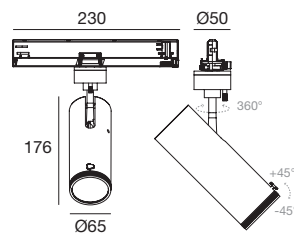

Fidelity - CRI 98		Cct	lm S - D CRI 98	Optic
White	82446	M 2700	2298 - On req	85 16° - 65°
Black	82447	W 3000	2427 - On req	
		N 4000	2667 - On req	

Balance - CRI 92		Cct	lm S - D CRI 92	Optic
White	82107	M 2700	2645 - On req	85 16° - 65°
Black	82108	W 3000	2770 - On req	
		N 4000	2978 - On req	

Pound Focus | Projectors | 198-264 V AC | arrayLED 32,5 W DC - 37 W AC

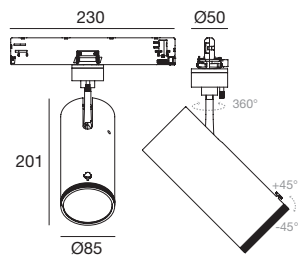

Fidelity - CRI 98		Cct	lm S - D CRI 98	Optic
White	82448	M 2700	3266 - On req	85 17° - 60°
Black	82449	W 3000	3450 - On req	
		N 4000	3790 - On req	

Balance - CRI 92		Cct	lm S - D CRI 92	Optic
White	82109	M 2700	3758 - On req	85 17° - 60°
Black	82110	W 3000	3937 - On req	
		N 4000	4232 - On req	

Pound Shaper_distance | Projectors | 176-264 V AC | arrayLED 11 W DC - 13 W AC

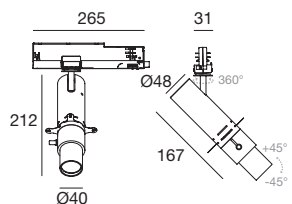

Fidelity - CRI 98		Cct	lm S - D CRI 98	Optic
White	82073	M 2700	1148 - 0n req	66 Shaper -
Black	82115	W 3000	1213 - 0n req	
		N 4000	1333 - 0n req	

Pound Shaper | Projectors | 176-264 V AC | arrayLED 11 W DC - 13 W AC

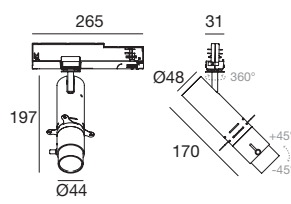

Fidelity - CRI 98		Cct	lm S - D CRI 98	Optic
White	82074	M 2700	1148 - 0n req	66 Shaper -
Black	82116	W 3000	1213 - 0n req	
		N 4000	1333 - 0n req	

Pound Shaper_distance | Projectors | 176-264 V AC | arrayLED 27 W DC - 30 W AC

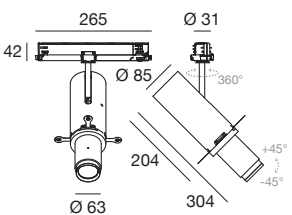

Fidelity - CRI 98		Cct	lm S - D CRI 98	Optic
White	82072	M 2700	2799 - 0n req	66 Shaper -
Black	82114	W 3000	2957 - 0n req	
		N 4000	3247 - 0n req	

Pound Shaper | Projectors | 176-264 V AC | arrayLED 27 W DC - 30 W AC

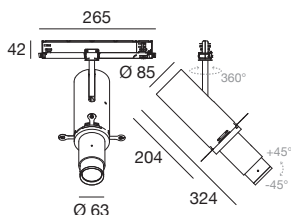

Fidelity - CRI 98		Cct	lm S - D CRI 98	Optic
White	82071	M 2700	2799 - 0n req	66 Shaper -
Black	82113	W 3000	2957 - 0n req	
		N 4000	3247 - 0n req	

Accessoires Pag. 185

Accessoires Pag. 185

Pound Shaper_distance | Projectors | 198-264 V AC | arrayLED 11 W DC - 13 W AC



Technology Partner
SILVAIR

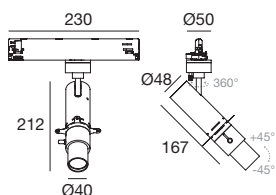

Fidelity - CRI 98		Cct	lm S - DCRI 98	Optic
White	83895	M 2700	1019 - 0n req	66 Shaper -
Black	83896	W 3000	1076 - 0n req	
		N 4000	1182 - 0n req	

Pound Shaper | Projectors | 198-264 V AC | arrayLED 11 W DC - 13 W AC



Technology Partner
SILVAIR

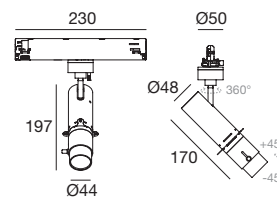

Fidelity - CRI 98		Cct	lm S - DCRI 98	Optic
White	83897	M 2700	1019 - 0n req	66 Shaper -
Black	83898	W 3000	1076 - 0n req	
		N 4000	1182 - 0n req	

Pound Shaper_distance | Projectors | 198-264 V AC | arrayLED 27 W DC - 30 W AC



Technology Partner
SILVAIR

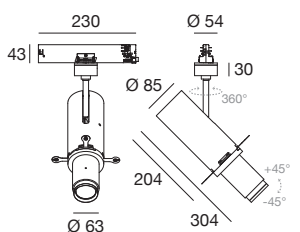

Fidelity - CRI 98		Cct	lm S - DCRI 98	Optic
White	83899	M 2700	2799 - 0n req	66 Shaper -
Black	83900	W 3000	2957 - 0n req	
		N 4000	3247 - 0n req	

Accessoires Pag. 185

Pound Shaper | Projectors | 198-264 V AC | arrayLED 27 W DC - 30 W AC



Technology Partner
SILVAIR

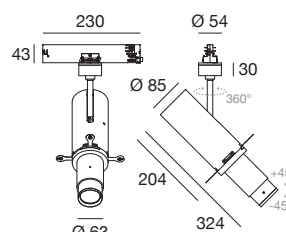

Fidelity - CRI 98		Cct	lm S - DCRI 98	Optic
White	83901	M 2700	2799 - 0n req	66 Shaper -
Black	83902	W 3000	2957 - 0n req	
		N 4000	3247 - 0n req	

Accessoires Pag. 185

Pound Shaper_distance | Projectors | 198-264 V AC | arrayLED 11 W DC - 13 W AC

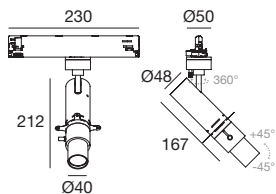

Fidelity - CRI 98		Cct	lm S - D CRI 98	Optic
White	82465	M 2700	1148 - 0n req	66 Shaper -
Black	82466	W 3000	1213 - 0n req	
		N 4000	1333 - 0n req	

Pound Shaper | Projectors | 198-264 V AC | arrayLED 11 W DC - 13 W AC

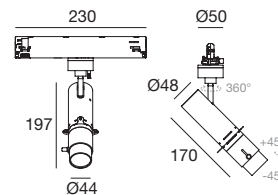

Fidelity - CRI 98		Cct	lm S - D CRI 98	Optic
White	82117	M 2700	1148 - 0n req	66 Shaper -
Black	82118	W 3000	1213 - 0n req	
		N 4000	1333 - 0n req	

Pound Shaper_distance | Projectors | 198-264 V AC | arrayLED 27 W DC - 30 W AC

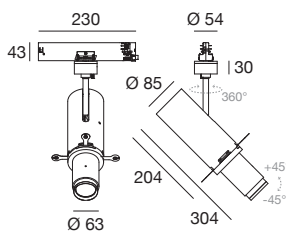

Fidelity - CRI 98		Cct	lm S - D CRI 98	Optic
White	82121	M 2700	2799 - 0n req	66 Shaper -
Black	82122	W 3000	2957 - 0n req	
		N 4000	3247 - 0n req	

Accessoires Pag. 185

Pound Shaper | Projectors | 198-264 V AC | arrayLED 27 W DC - 30 W AC

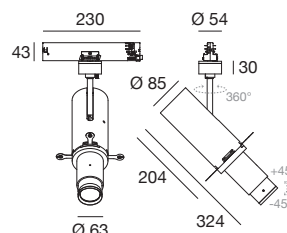

Fidelity - CRI 98		Cct	lm S - D CRI 98	Optic
White	82119	M 2700	2799 - 0n req	66 Shaper -
Black	82120	W 3000	2957 - 0n req	
		N 4000	3247 - 0n req	

Accessoires Pag. 185

Pound_BC | Projectors | arrayLED 13 W DC 350mA

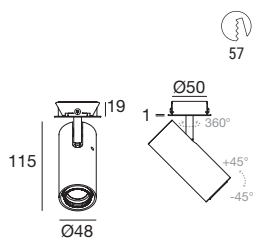

CRI 92	Cct	lm S - D CRI 92	Optic
White 82353	M 2700	1314 - On req	15 Spot -
Black 82354	W 3000	1376 - On req	30 Flood -
	N 4000	1480 - On req	60 W.Flood -

Électronique

99126	99115	99344
ON/OFF 1 art. p 134 x 137 x h 30	0/1-10V 1 art. p 210 x 148 x h 25	DALI 1 art. p 210 x 148 x h 25

Optiques & accessoires Pag. 184/185

Pound_BC | Projectors | arrayLED 25 W DC 700mA

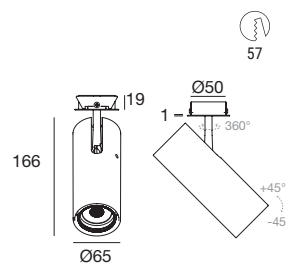

CRI 92	Cct	lm S - D CRI 92	Optic
White 82355	M 2700	2808 - On req	15 Spot -
Black 82356	W 3000	2941 - On req	30 Flood -
	N 4000	3161 - On req	60 W.Flood -

Électronique

99147	83008	99345
ON/OFF 1 art. p 103 x 158 x h 27	0/1-10V DALI PUSH 1 art. p 124 x 167 x h 22	DALI PUSH 1 art. p 210 x 148 x h 28

Optiques & accessoires Pag. 184/185

Pound_BC | Projectors | arrayLED 34 W DC 950mA

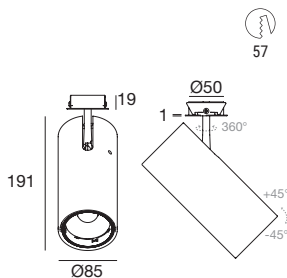

CRI 92	Cct	lm S - D CRI 92	Optic
White 82357	M 2700	3930 - On req	15 Spot -
Black 82358	W 3000	4117 - On req	30 Flood -
	N 4000	4426 - On req	60 W.Flood -

Électronique

99239	83008	99345
ON/OFF 1 art. p 103 x 158 x h 27	0/1-10V DALI PUSH 1 art. p 124 x 167 x h 22	DALI PUSH 1 art. p 210 x 148 x h 28

Optiques & accessoires Pag. 184/185

Pound_BS | Projectors | 198-264 V AC | arrayLED 13 W DC - 15,5 W AC

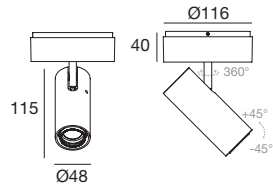

CRI 92	Cct	lm S - D CRI 92	Optic
White 82359	M 2700	1314 - 0n req	15 Spot -
Black 82360	W 3000	1376 - 0n req	30 Flood -
	N 4000	1480 - 0n req	60 W.Flood -

CRI 92 DALI	Cct	lm S - D CRI 92	Optic
White 82365	M 2700	1314 - 0n req	15 Spot -
Black 82366	W 3000	1376 - 0n req	30 Flood -
	N 4000	1480 - 0n req	60 W.Flood -

Optiques & accessoires Pag. 184/185

Pound_BS | Projectors | 198-264 V AC | arrayLED 25 W DC - 29 W AC

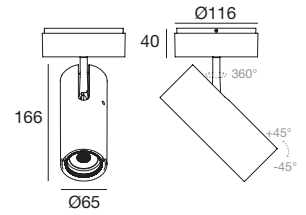

CRI 92	Cct	lm S - D CRI 92	Optic
White 82361	M 2700	2808 - 0n req	15 Spot -
Black 82362	W 3000	2941 - 0n req	30 Flood -
	N 4000	3161 - 0n req	60 W.Flood -

CRI 92 DALI	Cct	lm S - D CRI 92	Optic
White 82367	M 2700	2808 - 0n req	15 Spot -
Black 82368	W 3000	2941 - 0n req	30 Flood -
	N 4000	3161 - 0n req	60 W.Flood -

Optiques & accessoires Pag. 184/185

Pound_BS | Projectors | 198-264 V AC | arrayLED 34 W DC - 39 W AC

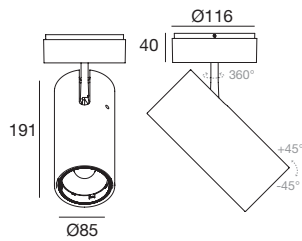

CRI 92	Cct	lm S - D CRI 92	Optic
White 82363	M 2700	3930 - 0n req	15 Spot -
Black 82364	W 3000	4117 - 0n req	30 Flood -
	N 4000	4426 - 0n req	60 W.Flood -

CRI 92 DALI	Cct	lm S - D CRI 92	Optic
White 82369	M 2700	3930 - 0n req	15 Spot -
Black 82370	W 3000	4117 - 0n req	30 Flood -
	N 4000	4426 - 0n req	60 W.Flood -

Optiques & accessoires Pag. 184/185

Optiques



description

99805 Spot

suitable for: Pound_T 13W / Pound_BC 13W
Pound_BS 13W



description

99806 Wide Flood

suitable for: Pound_T 13W / Pound_BC 13W
Pound_BS 13W



description

99807 Flood

suitable for: Pound_T 13W / Pound_BC 13W
Pound_BS 13W

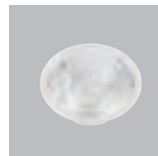

description

99827 Spot

suitable for: Pound_T 23W / 25W / Pound_BC 25W
Pound_BS 25W

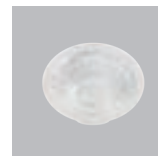

description

99828 Wide Flood

suitable for: Pound_T 23W / 25W / Pound_BC 25W
Pound_BS 25W

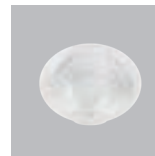

description

99829 Flood

suitable for: Pound_T 23W / 25W / Pound_BC 25W
Pound_BS 25W

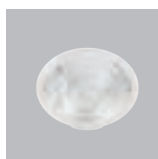

description

99808 Spot

suitable for: Pound_T / 31W / 32,5W / 34W Pound_BC 34W
Pound_BS 34W

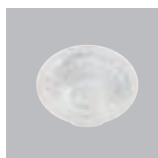

description

99809 Wide Flood

suitable for: Pound_T / 31W / 32,5W / 34W Pound_BC 34W
Pound_BS 34W



description

99810 Flood

suitable for: Pound_T / 31W / 32,5W / 34W Pound_BC 34W
Pound_BS 34W

Accessoires

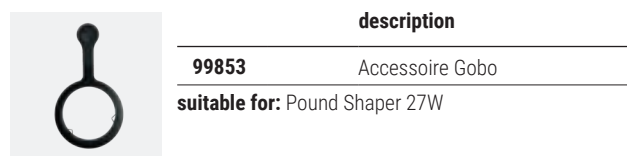
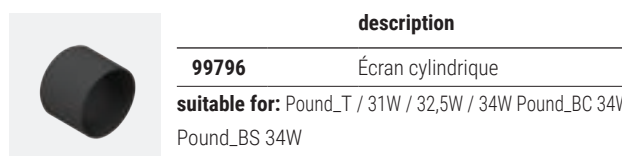
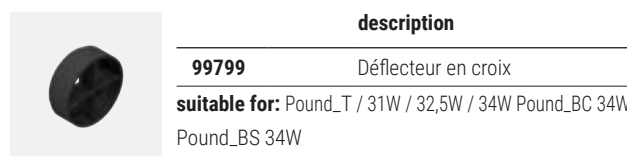
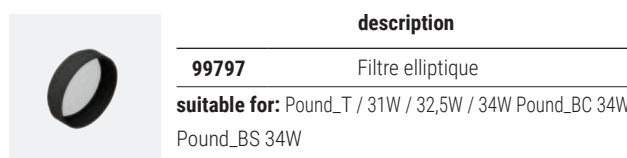
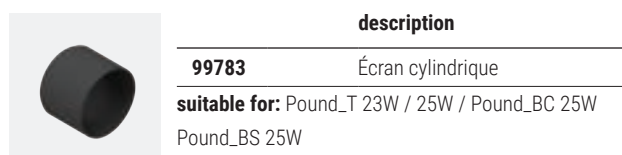
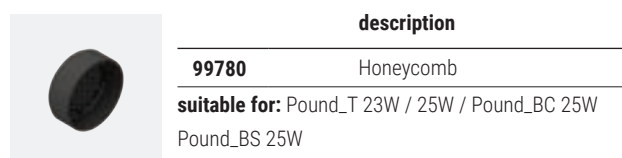
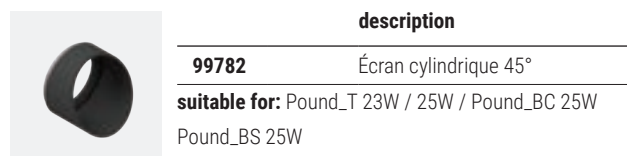
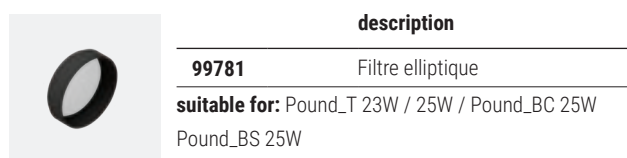
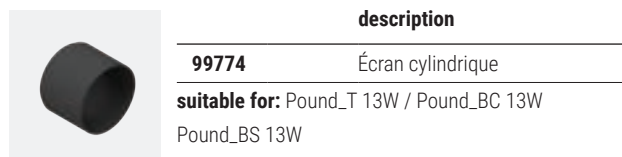
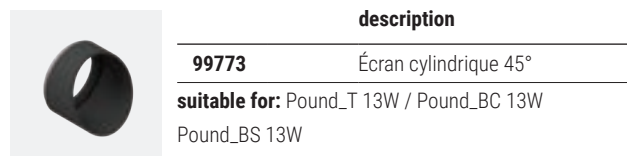



optus

Matériaux
Corps en aluminium



optus range



	_T	_T Dimmer	_Ww Wall Washer	_W2 / _W3
12W	-	Ø 66 mm	-	-
16W	Ø 66 mm	Ø 66 mm	-	-
17W	-	-	Ø 90 mm	-
23W	-	Ø 90 mm	-	-
24W	Ø 90 mm	Ø 90 mm	-	-
27W	-	-	Ø 105 mm	-
30W	-	-	-	280 x 98 mm
32W	-	Ø 105 mm	-	-
34W	Ø 105 mm	Ø 105 mm	-	-
45W	-	-	-	420 x 98 mm
Accessories			-	
Finish	White Black	White Black	White Black	White Black
Specialty CRI 98	3000K	3000K	-	3000K
Fidelity CRI 98	2700K - 3000K - 4000K	2700K - 3000K - 4000K	-	2700K - 3000K - 4000K
Balance CRI 92	2700K - 3000K - 4000K 5000K - Meat	2700K - 3000K - 4000K - 5000K	2700K - 3000K - 4000K	2700K - 3000K - 4000K
Optics	Spot - Flood - Wide Flood	Spot - Flood - Wide Flood	Asymm	Spot - Flood - Wide Flood
Control	On-Off	DALI 2 / Bluetooth / D.O.B	On-Off / Bluetooth / D.O.B	On-Off

Optus_T, malgré ses dimensions ultra-compactes, présente plusieurs avantages technologiques, tout d'abord l'adoption d'une optique TIR capable de réduire les faisceaux secondaires. Deuxièmement, la fixation du produit est conçue pour disparaître dans le rail triphasé, un dispositif qui permet de réduire encore l'encombrement. Pas uniquement technologie: le design compact et minimaliste fait d'Optus_T une solution polyvalente, adaptée à différents contextes, du retail à la muséographie.

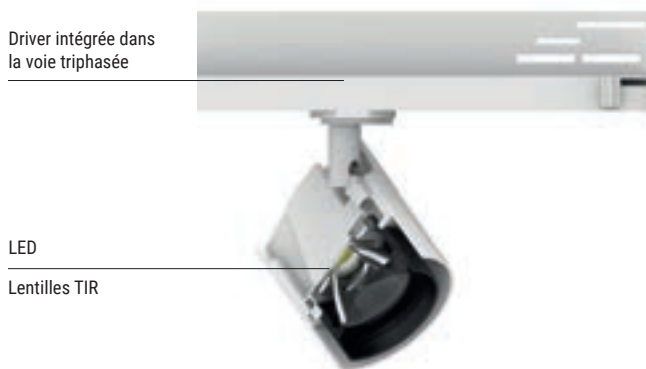

Gamme de LED

La gamme Optus_T offre le plus grand nombre de possibilités de combinaisons de sources ; elle peut être dotée des LED Balance - CRI 92, Specialty - CRI 98 et Fidelity - CRI 98. Elle permet ainsi une polyvalence maximale. Optus_T peut en effet être utilisée dans de nombreux secteurs, tels que les musées et la vente au détail, en fonction du type de source choisi.



Large gamme de produits

La famille Optus se décline en trois types d'applications : à encastrement (Optus_EX), murale (Optus_W) et sur rail (Optus_T). Grâce à son apparence unique, ce projecteur devient un outil efficace pouvant être utilisé dans plusieurs applications au sein d'un même espace tout en conservant le même design de produit.

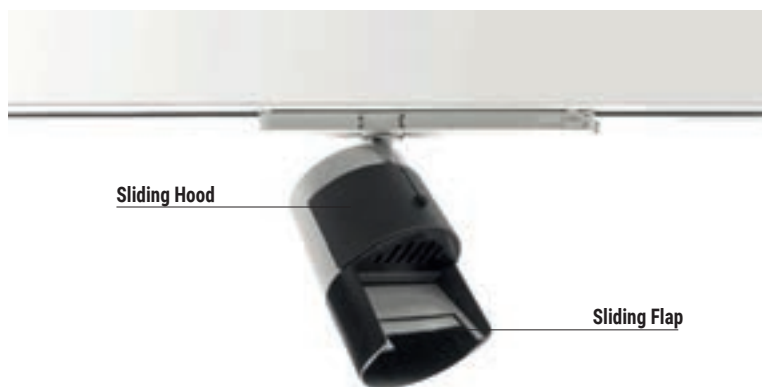

Optus_WW

Optus WW est équipé de la nouvelle technologie de contrôle de la lumière, c'est-à-dire des systèmes mécaniques Sliding Kickers et Sliding Hood placés dans le corps du projecteur. La technologie brevetée par les bureaux techniques i-léd réécrit les règles de l'éclairage et met en valeur avec précision à n'importe quelle distance. Optus WW s'adapte à l'espace et à l'objet à éclairer.

Optique dynamique variable

Un accessoire focal unique sur le marché, qui permet de régler la mise au point du faisceau lumineux et/ou le zoom à l'aide de deux bagues. L'installation plug and play permet d'obtenir une lumière dynamique et polyvalente en toutes situations.



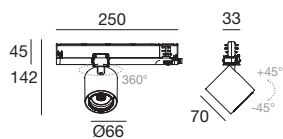

Specialty - CRI 98		Cct	lm S - D CRI 98	Optic
White	81647	W 3000	1779 - 1334	15 Spot (22°)
Black	81648			30 Flood (38°)
				60 W.Flood (63°)

Fidelity - CRI 98		Cct	lm S - D CRI 98	Optic
White	81645	W 3000	1779 - 1334	15 Spot (22°)
Black	81646	N 4000	1954 - 1433	30 Flood (38°)
				60 W.Flood (63°)

Balance - CRI 92		Cct	lm S - D CRI 92	Optic
White	81643	M 2700	1939 - 1447	15 Spot (22°)
Black	81644	W 3000	2030 - 1516	30 Flood (38°)
		N 4000	2182 - 1630	60 W.Flood (63°)

Optiques & accessoires Pag. 197

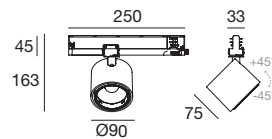

Specialty - CRI 98		Cct	lm S - D CRI 98	Optic
White	82239	W 3000	2785 - 2231	15 Spot (17°)
Black	82240			30 Flood (25°)
				60 W.Flood (52°)

Fidelity - CRI 98		Cct	lm S - D CRI 98	Optic
White	82237	M 2700	2636 - 2114	15 Spot (17°)
Black	82238	W 3000	2785 - 2331	30 Flood (25°)
		N 4000	3059 - 2453	60 W.Flood (52°)

Balance - CRI 92		Cct	lm S - D CRI 92	Optic
White	82235	M 2700	3033 - 2410	15 Spot (17°)
Black	82236	W 3000	3177 - 2546	30 Flood (25°)
		N 4000	3416 - 2796	60 W.Flood (52°)

Optiques & accessoires Pag. 197

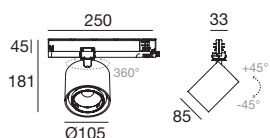

Specialty - CRI 98		Cct	lm S - D CRI 98	Optic
White	81659	W 3000	3608 - 2925	15 Spot (17°)
Black	81660			30 Flood (26°)
				60 W.Flood (51°)

Fidelity - CRI 98		Cct	lm S - D CRI 98	Optic
White	81657	W 3000	3608 - 2925	15 Spot (17°)
Black	81658	N 4000	3964 - 3214	30 Flood (26°)
				60 W.Flood (51°)

Balance - CRI 92		Cct	lm S - D CRI 92	Optic
White	81655	M 2700	3930 - 3187	15 Spot (17°)
Black	81656	W 3000	4117 - 3338	30 Flood (26°)
		N 4000	4426 - 3588	60 W.Flood (51°)
		C 5000	4555 - 3694	
		F Meat	2368 - On req	

Optiques & accessoires Pag. 197

RTG 81643W30 / 81643W60 / 81644W30 / 81644W60

RTG 81655W30 / 81655W60 / 81656W30 / 81656W60 / 81655N30 / 81656N30

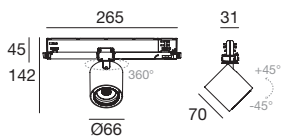

Specialty - CRI 98		Cct	lm S - D CRI 98	Optic
White	82889	W 3000	1779 - 1334	15 Spot (22°)
Black	82890			30 Flood (38°)
				60 W.Flood (63°)

Fidelity - CRI 98		Cct	lm S - D CRI 98	Optic
White	82891	W 3000	1770 - 1334	15 Spot (22°)
Black	82892	N 4000	1954 - 1433	30 Flood (38°)
				60 W.Flood (63°)

Balance - CRI 92		Cct	lm S - D CRI 92	Optic
White	82893	M 2700	1939 - 1447	15 Spot (22°)
Black	82894	W 3000	2030 - 1516	30 Flood (38°)
		N 4000	2182 - 1630	60 W.Flood (63°)

Optiques & accessoires Pag. 197

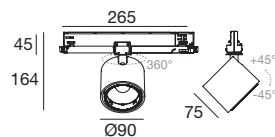

Specialty - CRI 98		Cct	lm S - D CRI 98	Optic
White	82895	W 3000	2785 - 2231	15 Spot (17°)
Black	82896			30 Flood (25°)
				60 W.Flood (52°)

Fidelity - CRI 98		Cct	lm S - D CRI 98	Optic
White	82897	M 2700	2636 - 2114	15 Spot (17°)
Black	82898	W 3000	2785 - 2231	30 Flood (25°)
		N 4000	3059 - 2453	60 W.Flood (52°)

Balance - CRI 92		Cct	lm S - D CRI 92	Optic
White	82899	M 2700	3033 - 2410	15 Spot (17°)
Black	82900	W 3000	3177 - 2546	30 Flood (25°)
		N 4000	3416 - 2796	60 W.Flood (52°)

Optiques & accessoires Pag. 197

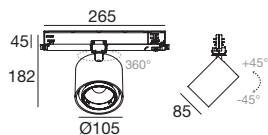

Specialty - CRI 98		Cct	lm S - D CRI 98	Optic
White	81818	W 3000	3608 - 2925	15 Spot (17°)
Black	81819			30 Flood (26°)
				60 W.Flood (51°)

Fidelity - CRI 98		Cct	lm S - D CRI 98	Optic
White	81816	W 3000	3608 - 2925	15 Spot (17°)
Black	81817	N 4000	3964 - 3214	30 Flood (26°)
				60 W.Flood (51°)

Balance - CRI 92		Cct	lm S - D CRI 92	Optic
White	81814	M 2700	3930 - 3187	15 Spot (17°)
Black	81815	W 3000	4117 - 3338	30 Flood (26°)
		N 4000	4426 - 3588	60 W.Flood (51°)
		C 5000	4555 - 3694	

Optiques & accessoires Pag. 197

RTG 81814W30 / 81814W60



Technology Partner
SILVAIR

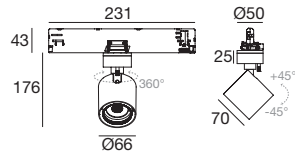

Specialty - CRI 98		Cct	lm S - D CRI 98	Optic
White	83903	W 3000	1423 - 1067	15 Spot (22°)
Black	83904			30 Flood (38°)
				60 W.Flood (63°)

Fidelity - CRI 98		Cct	lm S - D CRI 98	Optic
White	83905	W 3000	1423 - 1067	15 Spot (22°)
Black	83906	N 4000	1564 - 1147	30 Flood (38°)
				60 W.Flood (63°)

Balance - CRI 92		Cct	lm S - D CRI 92	Optic
White	83907	M 2700	1551 - 1158	15 Spot (22°)
Black	83908	W 3000	1624 - 1213	30 Flood (38°)
		N 4000	1746 - 1303	60 W.Flood (63°)

Optiques & accessoires Pag. 197



Technology Partner
SILVAIR

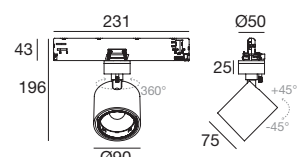

Specialty - CRI 98		Cct	lm S - D CRI 98	Optic
White	83909	W 3000	2610 - 2231	15 Spot (17°)
Black	83910			30 Flood (25°)
				60 W.Flood (52°)

Fidelity - CRI 98		Cct	lm S - D CRI 98	Optic
White	83911	W 3000	2610 - 2231	15 Spot (17°)
Black	83912	N 4000	2867 - 2453	30 Flood (25°)
				60 W.Flood (52°)

Balance - CRI 92		Cct	lm S - D CRI 92	Optic
White	83913	M 2700	2843 - 2410	15 Spot (17°)
Black	83914	W 3000	2977 - 2546	30 Flood (25°)
		N 4000	3201 - 2796	60 W.Flood (52°)

Optiques & accessoires Pag. 197



Technology Partner
SILVAIR

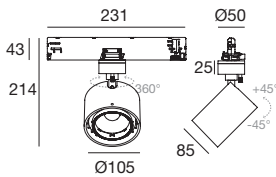

Specialty - CRI 98		Cct	lm S - D CRI 98	Optic
White	83915	W 3000	3450 - 2808	15 Spot (17°)
Black	83916			30 Flood (26°)
				60 W.Flood (51°)

Fidelity - CRI 98		Cct	lm S - D CRI 98	Optic
White	83917	W 3000	3450 - 2808	15 Spot (17°)
Black	83918	N 4000	3790 - 3085	30 Flood (26°)
				60 W.Flood (51°)

Balance - CRI 92		Cct	lm S - D CRI 92	Optic
White	83919	M 2700	3758 - 3060	15 Spot (17°)
Black	83920	W 3000	3937 - 3204	30 Flood (26°)
		N 4000	4232 - 3445	60 W.Flood (51°)

Optiques & accessoires Pag. 197

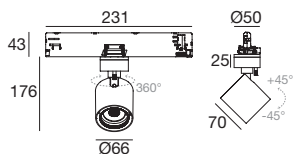

Specialty - CRI 98		Cct	lm S - D CRI 98	Optic
White	82373	W 3000	1423 - 1067	15 Spot (22°)
Black	82374			30 Flood (38°)
				60 W.Flood (63°)

Fidelity - CRI 98		Cct	lm S - D CRI 98	Optic
White	82371	W 3000	1423 - 1067	15 Spot (22°)
Black	82372	N 4000	1564 - 1147	30 Flood (38°)
				60 W.Flood (63°)

Balance - CRI 92		Cct	lm S - D CRI 92	Optic
White	82241	M 2700	1551 - 1158	15 Spot (22°)
Black	82242	W 3000	1624 - 1213	30 Flood (38°)
		N 4000	1746 - 1303	60 W.Flood (63°)

Optiques & accessoires Pag. 197

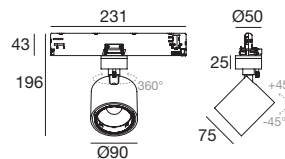

Specialty - CRI 98		Cct	lm S - D CRI 98	Optic
White	82377	W 3000	2610 - 2231	15 Spot (17°)
Black	82378			30 Flood (25°)
				60 W.Flood (52°)

Fidelity - CRI 98		Cct	lm S - D CRI 98	Optic
White	82375	W 3000	2610 - 2231	15 Spot (17°)
Black	82376	N 4000	2867 - 2453	30 Flood (25°)
				60 W.Flood (52°)

Balance - CRI 92		Cct	lm S - D CRI 92	Optic
White	82243	M 2700	3033 - 2410	15 Spot (17°)
Black	82244	W 3000	3177 - 2546	30 Flood (25°)
		N 4000	3416 - 2796	60 W.Flood (52°)

Optiques & accessoires Pag. 197

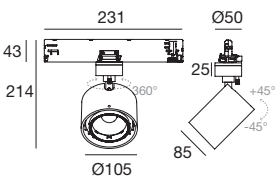

Specialty - CRI 98		Cct	lm S - D CRI 98	Optic
White	82381	W 3000	3450 - 2808	15 Spot (17°)
Black	82382			30 Flood (26°)
				60 W.Flood (51°)

Fidelity - CRI 98		Cct	lm S - D CRI 98	Optic
White	82379	W 3000	3450 - 2808	15 Spot (17°)
Black	82380	N 4000	3790 - 3085	30 Flood (26°)
				60 W.Flood (51°)

Balance - CRI 92		Cct	lm S - D CRI 92	Optic
White	82245	M 2700	3758v3060	15 Spot (17°)
Black	82246	W 3000	3937 - 3204	30 Flood (26°)
		N 4000	4232 - 3445	60 W.Flood (51°)

Optiques & accessoires Pag. 197

Optus_Ww | Projectors | 198-264 V AC | arrayLED 17 W DC - 19 W AC

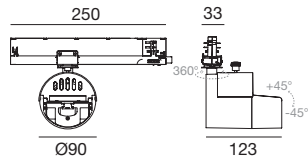

Balance - CRI 92		Cct	lm S - D CRI 92	Optic
White	82247	M 2700	2026 - On req	07 Asymm. -
Black	82248	W 3000	2174 - On req	
		N 4000	2520 - On req	

Optus_Ww | Projectors | 198-264 V AC | arrayLED 27 W DC - 30 W AC

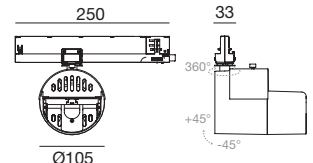

Balance - CRI 92		Cct	lm S - D CRI 92	Optic
White	82249	M 2700	3299 - On req	07 Asymm. -
Black	82250	W 3000	3540 - On req	
		N 4000	4103 - On req	

Optus_Ww | Projectors | 198-264 V AC | arrayLED 17 W DC - 19 W AC

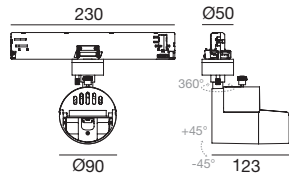

Balance - CRI 92		Cct	lm S - D CRI 92	Optic
White	83921	M 2700	2026 - On req	07 Asymm. -
Black	83922	W 3000	2174 - On req	
		N 4000	2520 - On req	

Optus_Ww | Projectors | 198-264 V AC | arrayLED 27 W DC - 30 W AC

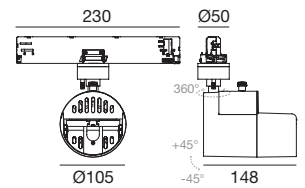

Balance - CRI 92		Cct	lm S - D CRI 92	Optic
White	83923	M 2700	3299 - On req	07 Asymm. -
Black	83924	W 3000	3540 - On req	
		N 4000	4103 - On req	

Optus_Ww | Projectors | 198-264 V AC | arrayLED 17 W DC - 19 W AC

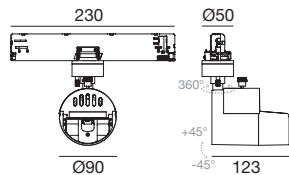

Balance - CRI 92		Cct	lm S - D CRI 92	Optic
White	82251	M 2700	2026 - On req	07 Asymm. -
Black	82252	W 3000	2174 - On req	
		N 4000	2520 - On req	

Optus_Ww | Projectors | 198-264 V AC | arrayLED 27 W DC - 30 W AC

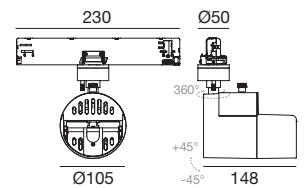

Balance - CRI 92		Cct	lm S - D CRI 92	Optic
White	82253	M 2700	3299 - On req	07 Asymm. -
Black	82254	W 3000	3540 - On req	
		N 4000	4103 - On req	

wall washer



Height 2,75 m
Distance 0,5 m
Tilted 12°
Sliding Hood Open
Sliding Flap Open



Height 2,75 m
Distance 1 m
Tilted 18°
Sliding Hood Closed
Sliding Flap Semi-Open



Height 2,75 m
Distance 1,5 m
Tilted 27°
Sliding Hood Closed
Sliding Flap Closed



Optus_W2 | Wall luminaires | arrayLED 30W DC 840mA

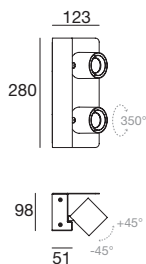

Specialty - CRI 98		Cct	lm S - D CRI 98	Optic
White	84174	W 3000	2x1604 - On req	15 Spot (21°)
Black	84175			30 Flood (36°)
				60 W.Flood (53°)

Fidelity - CRI 98		Cct	lm S - D CRI 98	Optic
White	84176	M 2700	2x1518 - On req	15 Spot (17°)
Black	84177	W 3000	2x1604 - On req	30 Flood (26°)
		N 4000	2x1792 - On req	60 W.Flood (51°)

Balance - CRI 92		Cct	lm S - D CRI 92	Optic
White	84172	M 2700	2x1748 - On req	15 Spot (17°)
Black	84173	W 3000	2x1830 - On req	30 Flood (26°)
		N 4000	2x1967 - On req	60 W.Flood (51°)

Optiques & accessoires Pag. 197

Électronique

99135	83008	99345
ON/OFF 1 art. p 103 x 158 x h 27	0/1-10V DALI PUSH 1 art. p 124 x 167 x h 22	DALI PUSH 1 art. p 210 x 148 x h 28

Optus_W3 | Wall luminaires | arrayLED 45W DC 1250mA

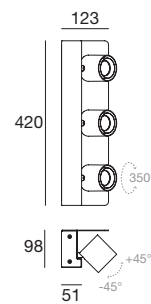

Specialty - CRI 98		Cct	lm S - D CRI 98	Optic
White	84180	W 3000	3x1604 - On req	15 Spot (17°)
Black	84181			30 Flood (26°)
				60 W.Flood (51°)

Fidelity - CRI 98		Cct	lm S - D CRI 98	Optic
White	84182	M 2700	3x1518 - On req	15 Spot (17°)
Black	84183	W 3000	3x1604 - On req	30 Flood (26°)
		N 4000	3x1792 - On req	60 W.Flood (51°)

Balance - CRI 92		Cct	lm S - D CRI 92	Optic
White	84178	M 2700	3x1748 - On req	15 Spot (17°)
Black	84179	W 3000	3x1830 - On req	30 Flood (26°)
		N 4000	3x1967 - On req	60 W.Flood (51°)

Optiques & accessoires Pag. 197

Électronique

83112	83008
ON/OFF 1 art. p 160 x 170 x h 36	0/1-10V DALI PUSH 1 art. p 124 x 167 x h 22

Optiques



description

99827 Spot

suitable for: Optus_T 12,5W / 16,2W / Optus_W2 / Optus_W3



description

99829 Wide Flood

suitable for: Optus_T 12,5W / 16,2W / Optus_W2 / Optus_W3



description

99808 Spot

suitable for: Optus_T 23W / 24W / 32,5W / 34W



description

99810 Wide Flood

suitable for: Optus_T 23W / 24W / 32,5W / 34W

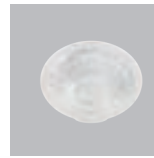

description

99828 Flood

suitable for: Optus_T 12,5W / 16,2W / Optus_W2 / Optus_W3



description

99844 Kit Focale

suitable for: Optus_T 12,5W / 16,2W / Optus_W2 / Optus_W3

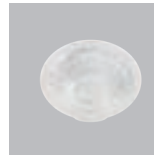

description

99809 Flood

suitable for: Optus_T 23W / 24W / 32,5W / 34W



description

99843 Kit Focale

suitable for: Optus_T 23W / 24W / 32,5W / 34W

Accessoires



description

99781 Filtre elliptique

suitable for: Optus_T 12,5W / 16,2W / Optus_W2 / Optus_W3



description

99779 Déflecteur en croix

suitable for: Optus_T 12,5W / 16,2W / Optus_W2 / Optus_W3



description

99782 Écran cylindrique 45°

suitable for: Optus_T 12,5W / 16,2W / Optus_W2 / Optus_W3



description

99780 Honeycomb

suitable for: Optus_T 12,5W / 16,2W / Optus_W2 / Optus_W3



description

99783 Écran cylindrique

suitable for: Optus_T 12,5W / 16,2W / Optus_W2 / Optus_W3

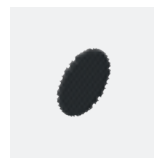

description

99841 Honeycomb

suitable for: Kit focale **99844**



description

99797 Filtre elliptique

suitable for: Optus_T 23W / 24W / 32,5W / 34W

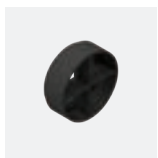

description

99799 Déflecteur en croix

suitable for: Optus_T 23W / 24W / 32,5W / 34W



description

99795 Écran cylindrique 45°

suitable for: Optus_T 23W / 24W / 32,5W / 34W

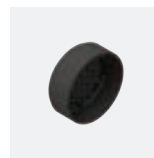

description

99798 Honeycomb

suitable for: Optus_T 23W / 24W / 32,5W / 34W



description

99796 Écran cylindrique

suitable for: Optus_T 23W / 24W / 32,5W / 34W

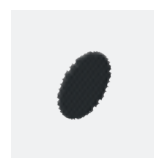

description

99842 Honeycomb

suitable for: Kit focale **99843**

cell

Matériaux
Corps en aluminium



Cell_Ww track | Ceiling lights | 198-264 V AC | 6 x powerLEDs | 19 W DC - 21 W AC

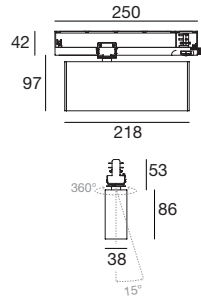

CRI 92	Cct	lm S - D CRI 92	Optic
White 83893	M 2700	2198 - On req	07 Asymm. -
Black 83894	W 3000	2304 - On req	
	N 4000	2852 - On req	





track system

Matériaux
Corps en aluminium

track system configuration

Continuité de la mise à la terre

Il est important d'assurer la continuité de la ligne de mise à la terre entre tous les éléments constituant le système de rail triphasé.

Comme le montre la section du rail illustrée ci-contre, la position de la ligne de terre (en rouge) est asymétrique par rapport à l'axe central du rail ; grâce à cette différence structurelle, il est possible de distinguer la partie droite (incluant la ligne de terre) qui relie entre eux tous les accessoires. Le conducteur de terre doit par conséquent être positionné entre l'accessoire et la structure du rail électrifié.

Configuration

Pour assurer une bonne configuration, il est suggéré de composer la structure avec vue en plan depuis le haut, tel que représenté dans le dessin suivant :

Vue en plan d'en haut



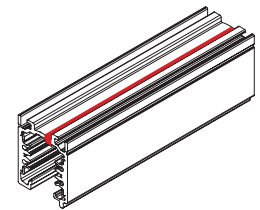
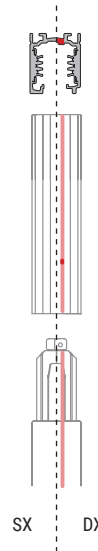





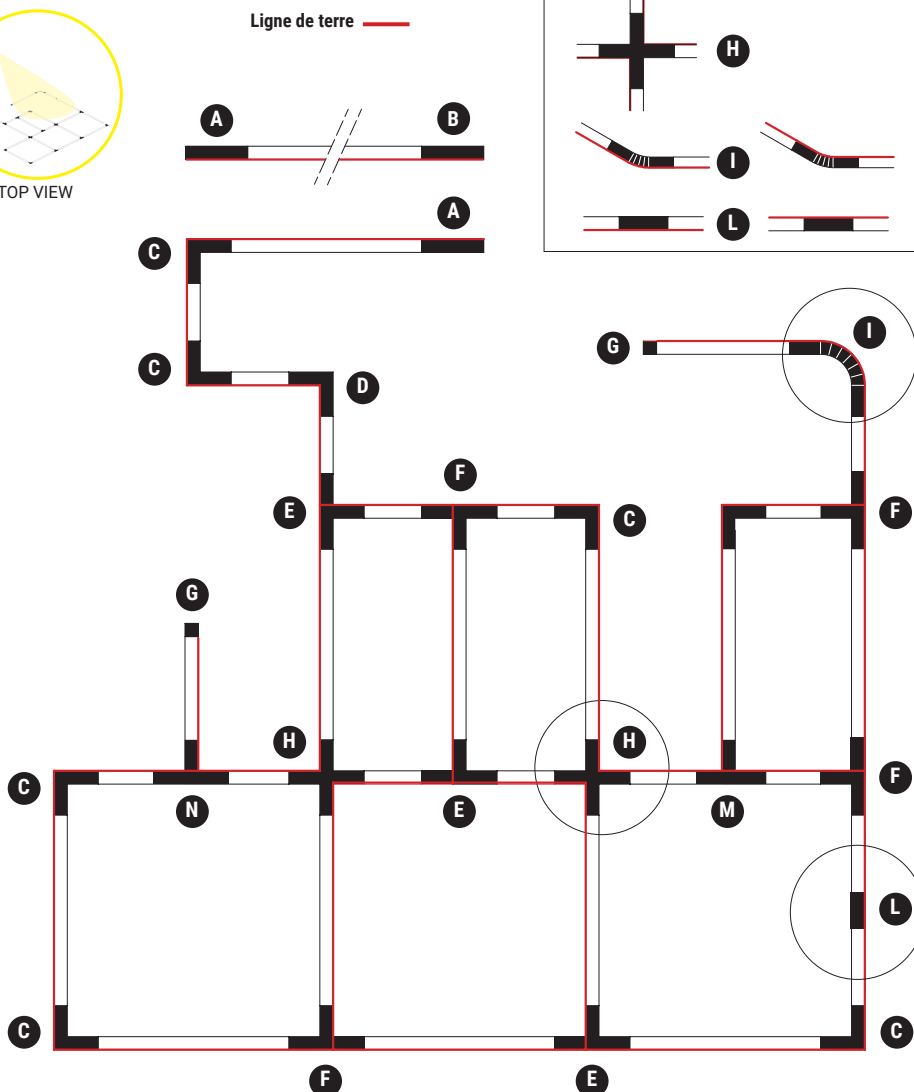
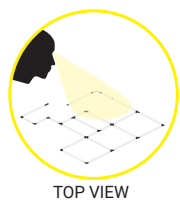



Vue axonométrique

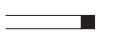

Vue en plan

Les accessoires « H », « I » et « L » peuvent être utilisés dans les deux sens.



- A**  81033
- B**  81036
- C**  81048
- D**  81045
- E**  81051
- F**  81054
- G**  80999
- H**  81063
- I**  81066
- L**  81042
- M**  81057
- N**  81060

Track system | Rail triphasé + DALI | Plafonnier/Suspension



Track system | Rail triphasé + DALI | Encastré

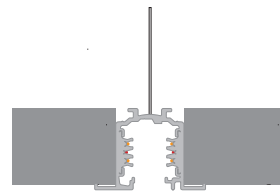

Track system | Rail triphasé + DALI



	1 M	2 M	3 M
White	80981	80982	80983
Black	80984	80985	80986

Track system | Alimentation de tête



	POWER DX	POWER SX
White	81033	81036
Black	81034	81037

Track system | Joint central



White	81042
Black	81043

Track system | Joint flexible

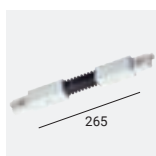

White	81066
Black	81067

Track system | Joint en T



	EST/SX	EST/DX
White	81051	81054
Black	81052	81055

Track system | Bouchon de fermeture | Plafonnier/Suspension

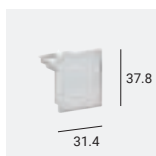

White	80999
Black	81000

Track system | Rail triphasé à encastrer + DALI



	1 M	2 M	3 M
White	80990	80991	80992
Black	80993	80994	80995

Track system | Joint électrique interne



White	81039
Black	81040

Track system | Joint en L

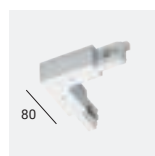

	INT	EST
White	81045	81048
Black	81046	81049

Track system | Joint en X



White	81063
Black	81064

Track system | Joint en T



	INT/SX	INT/DX
White	81057	81060
Black	81058	81061

Track system | Bouchon de fermeture | Rail encastré



White	81002
Black	81003

Track system | Suspension

	1.5 m	5 m
White	81012	81013
Black	81014	81015

**Track system** | Suspension rigide

	1 m
White	81021
Black	81022

**Track system** | Support de fixation au plafond

Anod. Al.	81086
White	81087
Black	81088

**Track system** | Couverture de la tête d'alimentation

White	81069
Black	81070

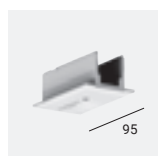
**Track system** | Couverture joint en L

White	81075
Black	81076

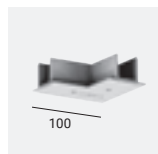
**Track system** | Couverture joint en X

White	81081
Black	81082

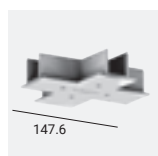
**Track system** | Adaptateur pour rail triphasé *

White	81094
Black	81095

*À utiliser uniquement pour la connexion au secteur 220V.

**Track system** | Pince coupante pour conducteurs

Anod. Al.	81005
-----------	-------

**Track system** | Suspension avec régulateur

	1.5 m	5 m
White	81006	81007
Black	81008	81009

**Track system** | Clip de tensionnement pour suspension rigide

White	81018
Black	81019

**Track system** | Support de rigidification

Anod. Al.	81024
White	81025
Black	81026

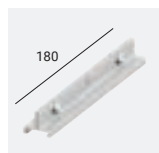
**Track system** | Couverture joint central

White	81072
Black	81073

**Track system** | Couverture joint en T

White	81078
Black	81079

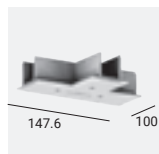
**Track system** | Garniture pour tête d'alimentation

White	81084
Black	81085

**Track system** | Adaptateur pour rail triphasé + DALI *

White	81091
Black	81093

*À utiliser uniquement pour la connexion au secteur 220V et/ou au signal DALI.









navata

Matériaux
Structure en aluminium



Bras à chaîne articulée Double rotation sur base et luminaire

Le système Navata permet une large gamme de mouvements pour un éclairage aussi polyvalent que possible, capable de dépasser les limites liées aux installations dans des espaces étroits ou restreints. Le bras à chaîne articulée possède une grande liberté de mouvement, permettant de plier entièrement le projecteur sur lui-même ou de l'éloigner de la base jusqu'à une distance notable. La double rotation au niveau de la base et du luminaire permet d'orienter le projecteur à 360° et d'obtenir le positionnement souhaité



Navata Optus

La gamme Navata Optus propose une gamme optique mise à jour qui vous permet de valoriser l'architecture, par exemple, d'un lieu de culte tout en respectant son contexte.

Les dimensions réduites de la structure semblent presque disparaître et les faisceaux correctement orientés vont mettre en valeur: coupoles, voûtes, murs, en créant de véritables chemins de lumière

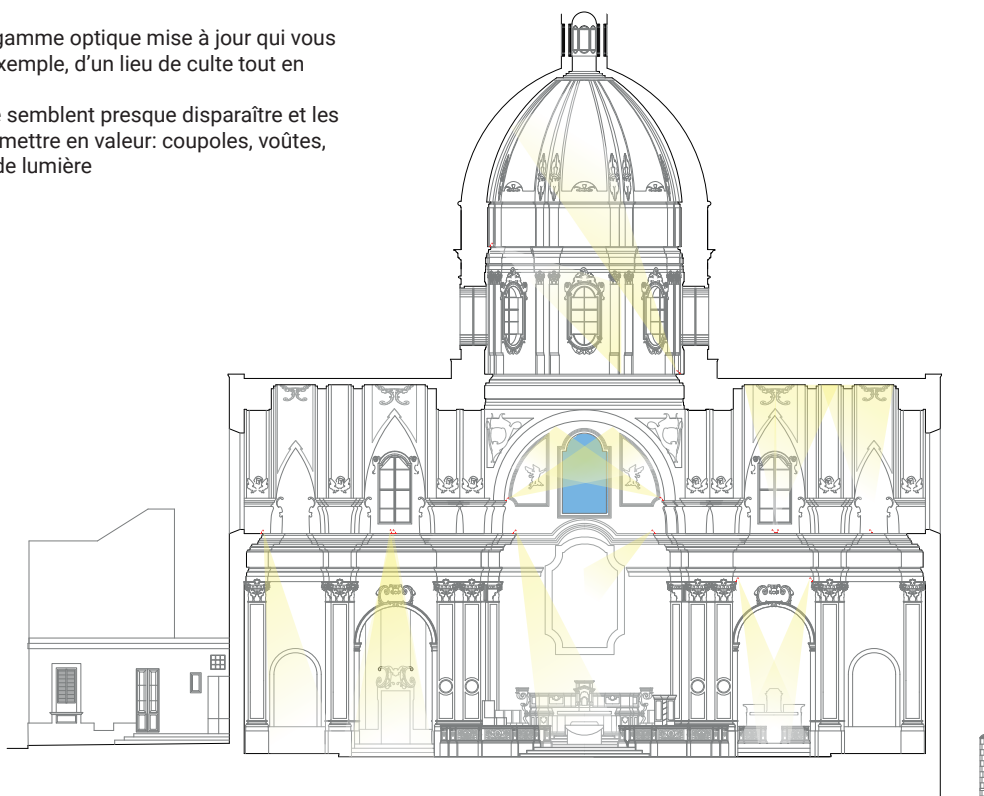

Navata Pound Shaper

La gamme Navata Pound Shaper avec le système de lentilles spéciales qui garantit une efficacité maximale et la bonne qualité de lumière, vous permet de définir clairement toutes types de tableaux même avec des mesures jusqu'à 3,30 mètres x 3,30 mètres, le détail d'une œuvre d'art ou les détails architecturaux. Les éléments éclairés avec une précision remarquable deviennent ainsi les protagonistes du projet.

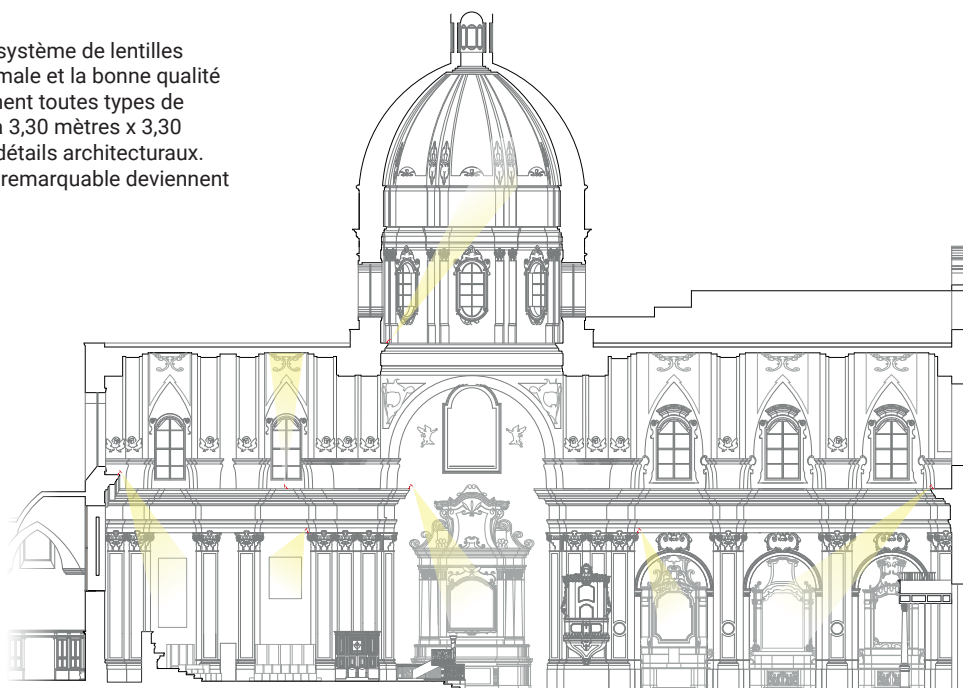

Rapport de profilage

Navata Pound Shaper 27W

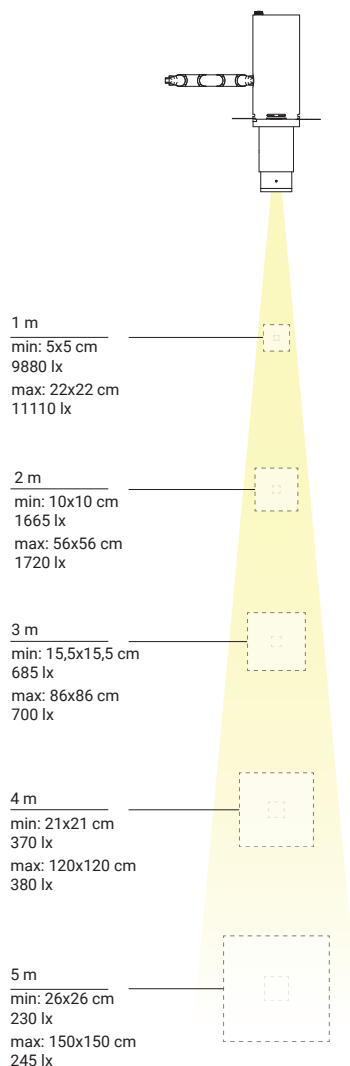

Navata Pound Shaper distance 27W

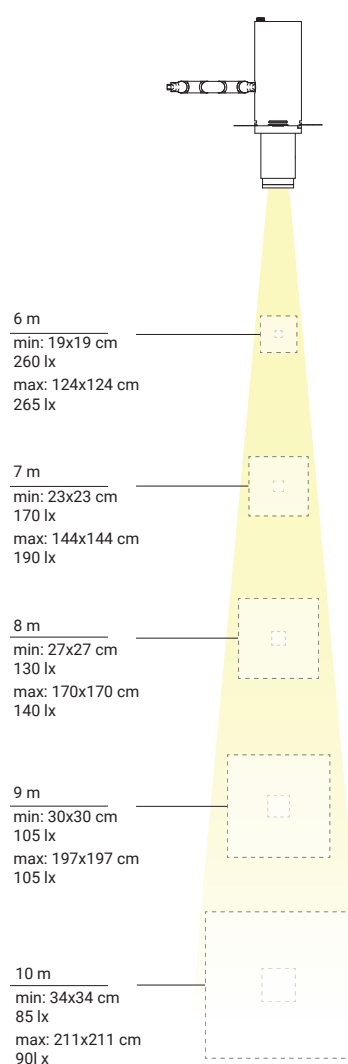

Navata_Optus | Projectors | arrayLED 16 W DC 450mA

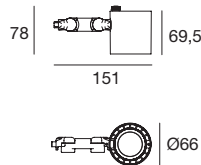

Specialty - CRI 98	Cct	lm S - D CRI 98	Optic
White 82387	W 3000	1779 - 1334	15 Spot (22°)
Black 82388			30 Flood (38°)
Sand 82901			60 W.Flood (63°)

Fidelity - CRI 98	Cct	lm S - D CRI 98	Optic
White 82385	W 3000	1779 - 1334	15 Spot (22°)
Black 82386	N 4000	1954 - 1433	30 Flood (38°)
Sand 82902			60 W.Flood (63°)

Balance - CRI 92	Cct	lm S - D CRI 92	Optic
White 82383	W 3000	2030 - 1516	15 Spot (22°)
Black 82384	N 4000	2182 - 1630	30 Flood (38°)
Sand 82903			60 W.Flood (63°)

Optiques & accessoires Pag. 213

Base pour l'installation Pag. 212

Navata_Optus | Projectors | arrayLED 34 W DC 950mA

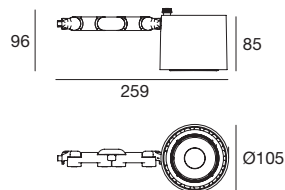

Specialty - CRI 98	Cct	lm S - D CRI 98	Optic
White 82399	W 3000	3608 - On req	15 Spot (17°)
Black 82400			30 Flood (26°)
Sand 82907			60 W.Flood (51°)

Fidelity - CRI 98	Cct	lm S - D CRI 98	Optic
White 82397	W 3000	3608 - On req	15 Spot (17°)
Black 82398	N 4000	3964 - On req	30 Flood (26°)
Sand 82908			60 W.Flood (51°)

Balance - CRI 92	Cct	lm S - D CRI 92	Optic
White 82395	M 2700	3930 - 3187	15 Spot (17°)
Black 82396	W 3000	4117 - 3338	30 Flood (26°)
Sand 82909	N 4000	4426 - 3588	60 W.Flood (51°)
	C 5000	4555 - 3694	

Optiques & accessoires Pag. 213

Base pour l'installation Pag. 212

Navata_Optus | Projectors | arrayLED 24 W DC 700mA

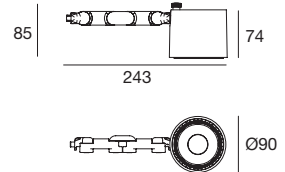
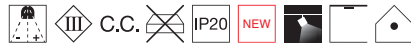

Specialty - CRI 98	Cct	lm S - D CRI 98	Optic
White 82393	W 3000	2785 - 2231	15 Spot (17°)
Black 82394			30 Flood (25°)
Sand 82904			60 W.Flood (52°)

Fidelity - CRI 98	Cct	lm S - D CRI 98	Optic
White 82391	M 2700	2636 - 2114	15 Spot (17°)
Black 82392	W 3000	2785 - 2231	30 Flood (25°)
Sand 82905	N 4000	3059 - 2453	60 W.Flood (52°)

Balance - CRI 92	Cct	lm S - D CRI 92	Optic
White 82389	M 2700	3033 - 2410	15 Spot (17°)
Black 82390	W 3000	3177 - 2546	30 Flood (25°)
Sand 82906	N 4000	3416 - 2796	60 W.Flood (52°)

Optiques & accessoires Pag. 213

Base pour l'installation Pag. 212

RTG 82387W15

RTG 82393W15

RTG 82399W15

Navata Pound Shaper distance | Projectors | arrayLED 11 W DC 300mA

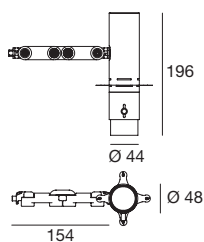

Fidelity - CRI 98		Cct	lm S - D CRI 98	Optic
White	82627	M 2700	1019 - On req	66 Shaper -
Black	82628	W 3000	1076 - On req	
Sand	82910	N 4000	1182 - On req	

Base pour l'installation Pag. 212

Navata Pound Shaper | Projectors | arrayLED 11 W DC 300mA

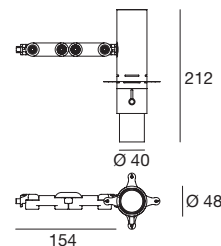

Fidelity - CRI 98		Cct	lm S - D CRI 98	Optic
White	82625	M 2700	1019 - On req	66 Shaper -
Black	82626	W 3000	1076 - On req	
Sand	82911	N 4000	1182 - On req	

Base pour l'installation Pag. 212

Navata Pound Shaper distance | Projectors | arrayLED 27 W DC 700mA

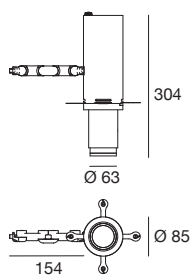

Fidelity - CRI 98		Cct	lm S - D CRI 98	Optic
White	82631	M 2700	2636 - On req	66 Shaper -
Black	82632	W 3000	2785 - On req	
Sand	82912	N 4000	3059 - On req	

Base pour l'installation Pag. 212

Navata Pound Shaper | Projectors | arrayLED 27 W DC 700mA

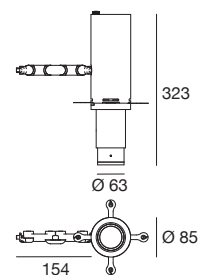

Fidelity - CRI 98		Cct	lm S - D CRI 98	Optic
White	82629	M 2700	2636 - On req	66 Shaper -
Black	82630	W 3000	2785 - On req	
Sand	82913	N 4000	3059 - On req	

Base pour l'installation Pag. 212

Base | On/Off | 198 - 264V AC | 300mA - 1050mA

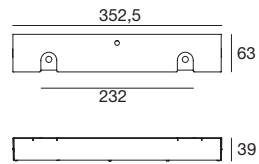

White	99938	From 11 to 38 W DC
Black	99943	From 11 to 38 W DC
Sand	83055	From 11 to 38 W DC

Base | DALI | 198 - 264V AC | 300mA - 1050mA

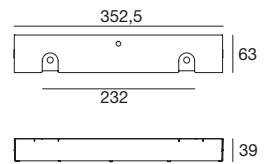

White	99936	From 11 to 38 W DC
Black	99941	From 11 to 38 W DC
Sand	83054	From 11 to 38 W DC

RTG 99936

Base | bluetooth | 198 - 264V AC | 300mA - 950mA



Technology Partner
SILVAIR

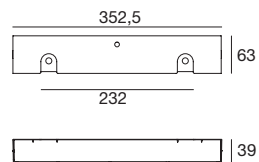

350 mA

White	99935	11W DC 300mA
Black	99940	11W DC 300mA
Sand	83053	11W DC 300mA

400 mA

White	83168	16W DC 450mA
Black	83169	16W DC 450mA
Sand	83170	16W DC 450mA

700 mA

White	83171	24W DC 700mA
Black	83172	24W DC 700mA
Sand	83173	24W DC 700mA

950 mA

White	83174	34W DC 950mA
Black	83175	34W DC 950mA
Sand	83176	34W DC 950mA

Pag. 213

RTG 99809 / 99810 / 99828 / 99829

Optiques



description	
99827	Spot
suitable for: Navata_Optus 16W	



description	
99829	Wide Flood
suitable for: Navata_Optus 16W	



description	
99808	Spot
suitable for: Navata_Optus 24W / 34W	



description	
99810	Wide Flood
suitable for: Navata_Optus 24W / 34W	



description	
99828	Flood
suitable for: Navata_Optus 16W	



description	
99844	Kit Focale
suitable for: Navata_Optus 16W	



description	
99809	Flood
suitable for: Navata_Optus 24W / 34W	



description	
99843	Kit Focale
suitable for: Navata_Optus 24W / 34W	

Accessoires



description	
99781	Filtre elliptique
suitable for: Navata_Optus 16W	



description	
99779	Défecteur en croix
suitable for: Navata_Optus 16W	



description	
99782	Écran cylindrique 45°
suitable for: Navata_Optus 16W	



description	
99780	Honeycomb
suitable for: Navata_Optus 16W	



description	
99783	Écran cylindrique
suitable for: Navata_Optus 16W	

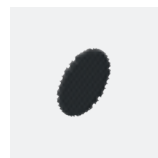

description	
99841	Honeycomb
suitable for: Kit focale 99844	



description	
99797	Filtre elliptique
suitable for: Navata_Optus 24W / 34W	

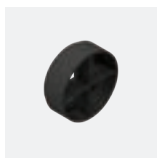

description	
99799	Défecteur en croix
suitable for: Navata_Optus 24W / 34W	



description	
99795	Écran cylindrique 45°
suitable for: Navata_Optus 24W / 34W	

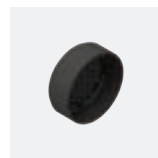

description	
99798	Honeycomb
suitable for: Navata_Optus 24W / 34W	



description	
99796	Écran cylindrique
suitable for: Navata_Optus 24W / 34W	

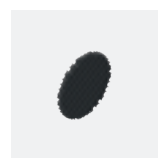

description	
99842	Honeycomb
suitable for: Kit focale 99843	



creek

Matériaux

Structure en EPS

Projecteur en aluminium



creek range

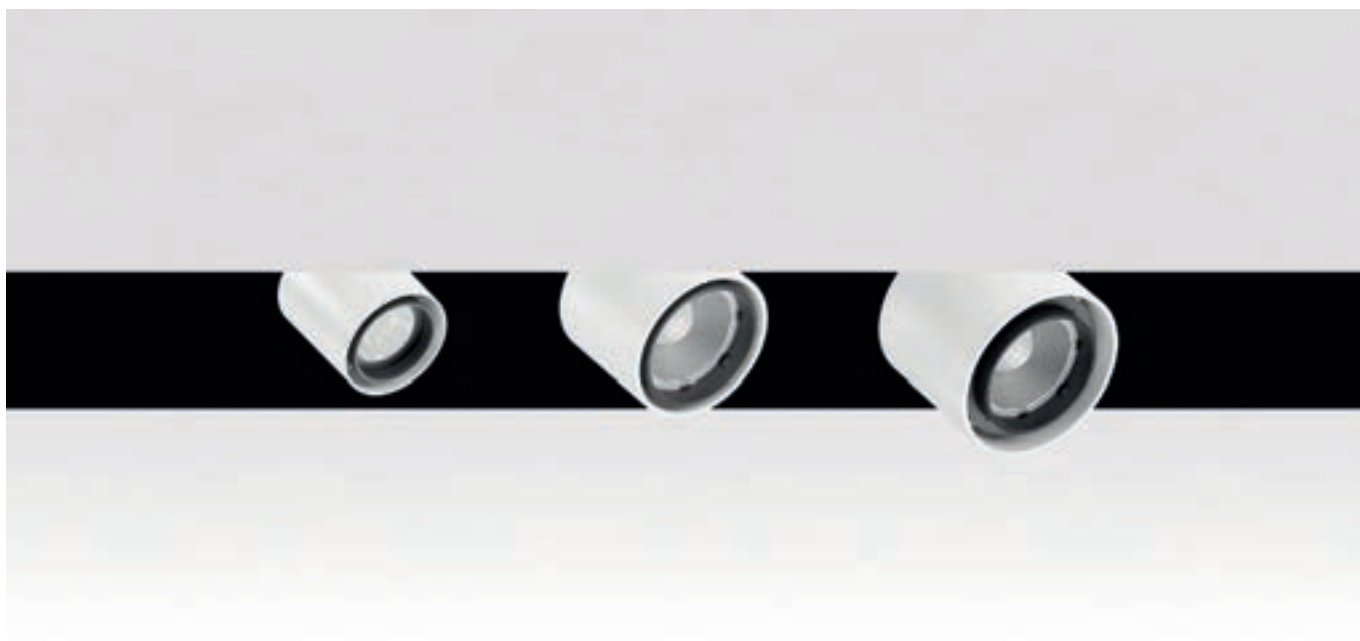

Creek Optus

16W	66 mm
24W	90 mm
34W	105 mm
Accessories	
Finish	<input type="checkbox"/> White <input checked="" type="checkbox"/> Black
Balance CRI 92	2700K - 3000K - 4000K
Optics	Spot - Flood - Wide Flood

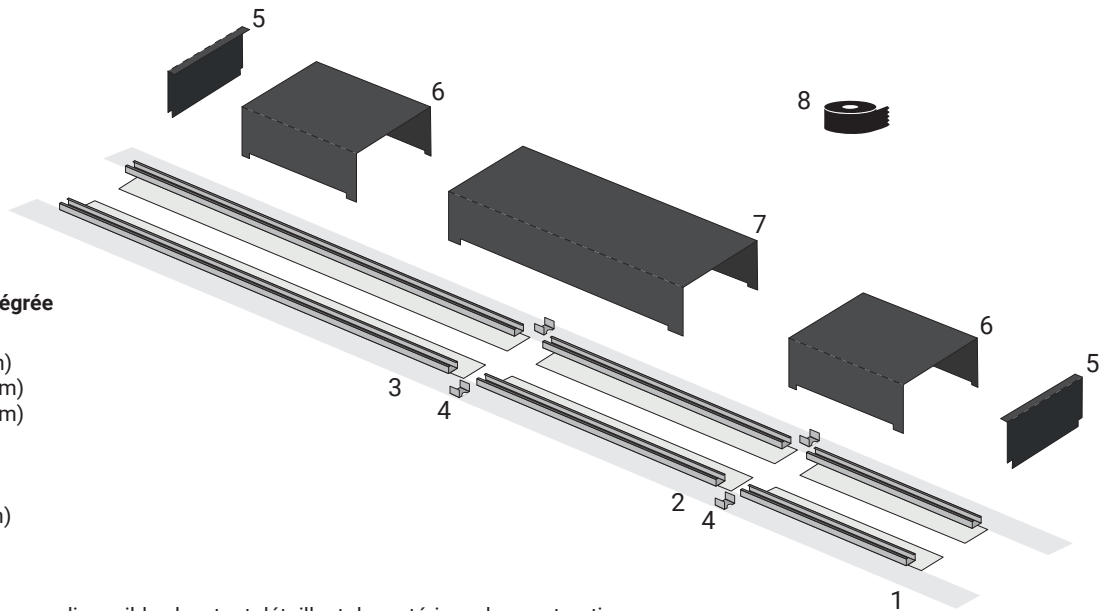

Solutions d'architecture intégrée

- 1 | Profils linéaires (500 mm)
- 2 | Profils linéaires (1000 mm)
- 3 | Profils linéaires (1500 mm)
- 4 | Joint mécanique*
- 5 | Carter final
- 6 | Carter linéaire (500 mm)
- 7 | Carter linéaire (1000 mm)
- 8 | Ruban Adhésif

*article fourni par l'installateur ou disponible chez tout détaillant de matériaux de construction.

Taille de la structure

La nouvelle structure de Creek s'adapte parfaitement à l'entraxe standard des montants d'un faux-plafond avec un trou de seulement 370 mm. Les profilés linéaires, constitués de montants standards associés à des panneaux EPS, peuvent être facilement combinés en ligne grâce au joint mécanique. Une fois que le profil linéaire est posé et fixé, il sera possible de exécuter le mastiquage et de peindre le panneau EPS qui, grâce à ses caractéristiques, assurera l'uniformité avec la plaque de plâtre du plafond.

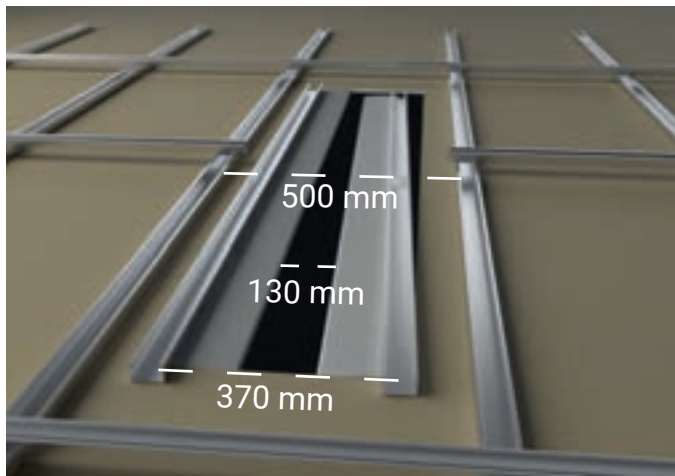

Panneau EPS

Le panneau EPS s'accouple directement avec le faux plafond en plaques de plâtre avec la possibilité d'être poncé et traité de la même manière. Une fois terminé, il n'y aura aucune différence de finition.

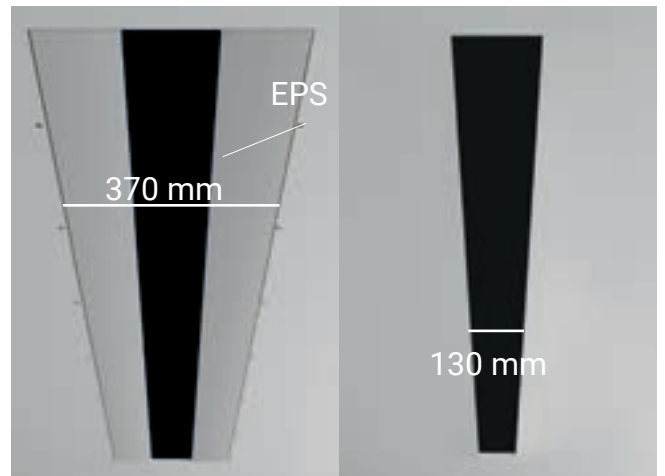

Phase d'installation du produit

ÉTAPE 1



Une fois que la structure est mise en place dans le faux plafond, le projecteur doit être positionné dans le carter linéaire.

ÉTAPE 2



La fixation se fait par emboîtement, en insérant l'extrémité de la base dans le logement interne du profilé.

ÉTAPE 3



Pour achever le processus, appuyer sur la base vers le bas près du point de départ du bras articulé.

Cartier supérieur de couverture

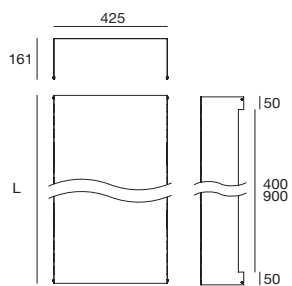

code	type	Lmm
99927	Black	500
99928	Black	1000

Bouchon de fermeture

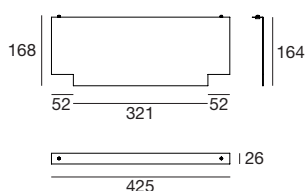

code	type
99929	Black

Profil linéaire_P (paire)

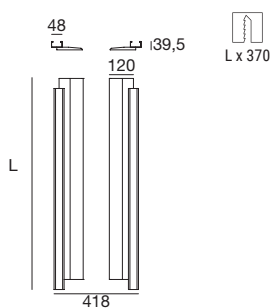

code	type	Lmm
82728	White	500
82729	White	1000
82730	White	1500

Creek Optus | powerLED 16 W DC 450mA

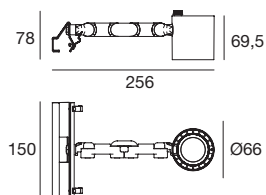
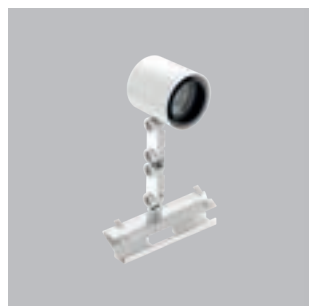

	Balance - CRI 92	Cct	lm S - D CRI 92	Optic
White	82731	M 2700	1939 - On req	15 Spot (12°)
Black	82732	W 3000	2030 - On req	30 Flood (26°)
		N 4000	2182 - On req	60 W.Flood (51°)

Électronique

99734	99732	99730
ON/OFF 1 art. p 134 x 137 x h 31	0/1-10V 1 art. p 134 x 137 x h 31	DALI PUSH 1 art. p 134 x 137 x h 31

Optiques & accessoires Pag. 220

Creek Optus | powerLED 24 W DC 700mA

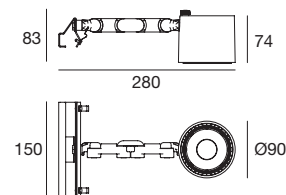

	Balance - CRI 92	Cct	lm S - D CRI 92	Optic
White	82733	M 2700	3033 - On req	15 Spot (12°)
Black	82734	W 3000	3177 - On req	30 Flood (26°)
		N 4000	3416 - On req	60 W.Flood (51°)

Électronique

99147	83008	99345
ON/OFF 1 art. p 103 x 158 x h 27	0/1-10V DALI PUSH 1 art. p 124 x 167 x h 22	DALI PUSH 1 art. p 210 x 148 x h 28

Optiques & accessoires Pag. 220

Creek Optus | arrayLED 34 W DC 950mA

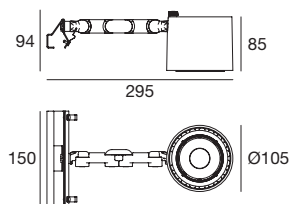

	Balance - CRI 92	Cct	lm S - D CRI 92	Optic
White	82735	M 2700	3930 - On req	15 Spot (12°)
Black	82736	W 3000	4117 - On req	30 Flood (26°)
		N 4000	4426 - On req	60 W.Flood (51°)

Électronique

99239	83008	99345
ON/OFF 1 art. p 103 x 158 x h 27	0/1-10V DALI PUSH 1 art. p 124 x 167 x h 22	DALI PUSH 1 art. p 210 x 148 x h 28

Optiques & accessoires Pag. 220

Optiques

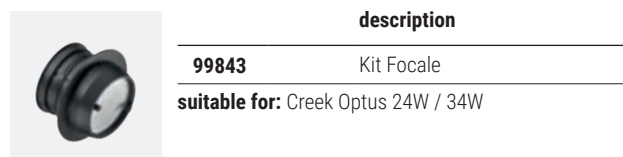
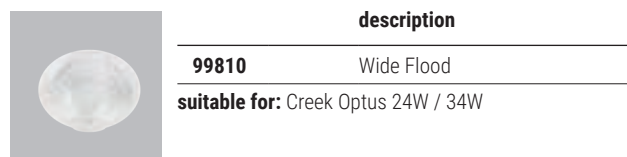
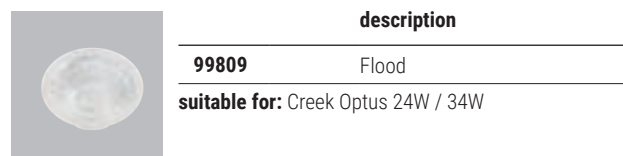
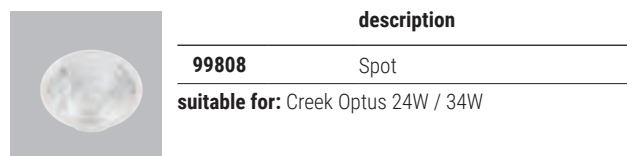
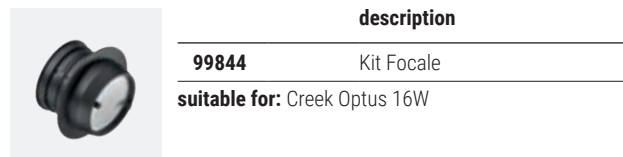
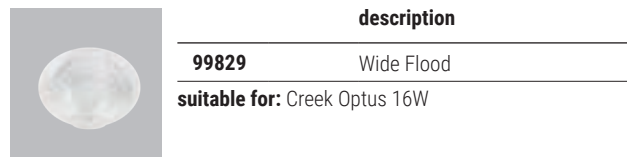
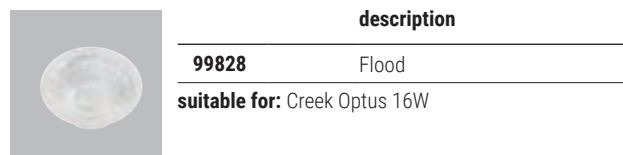
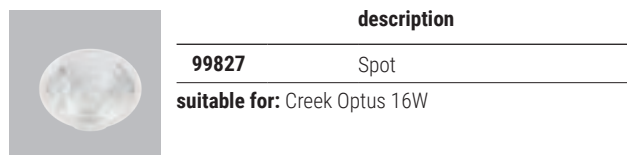

Accessoires

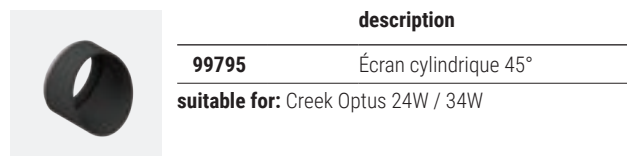
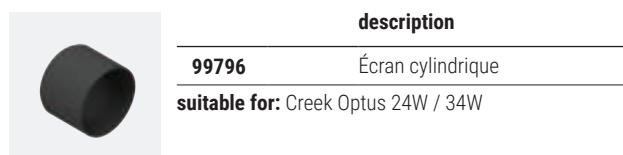
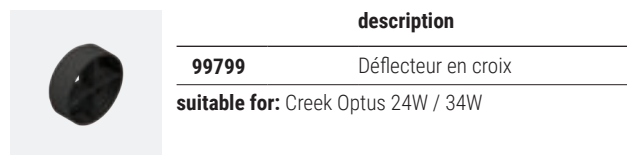
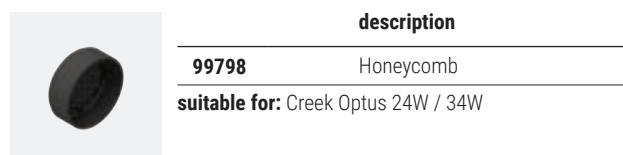
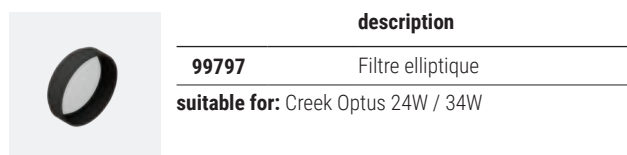
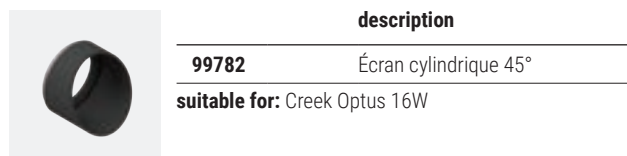
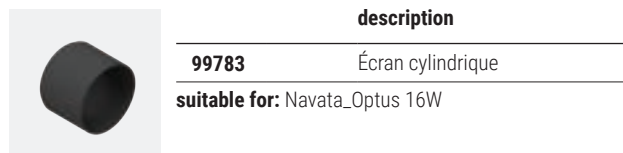
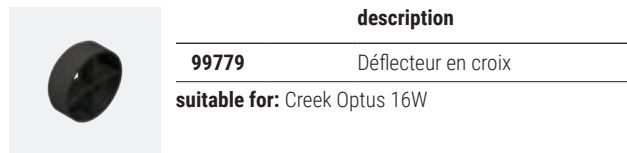
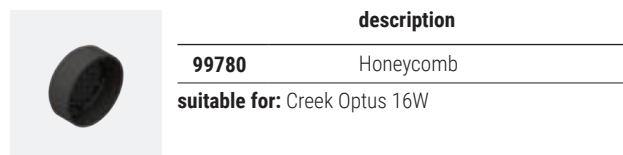
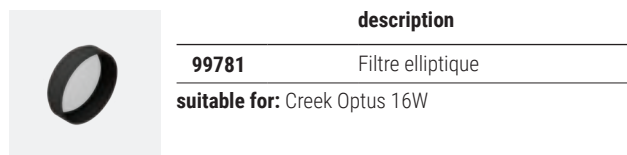







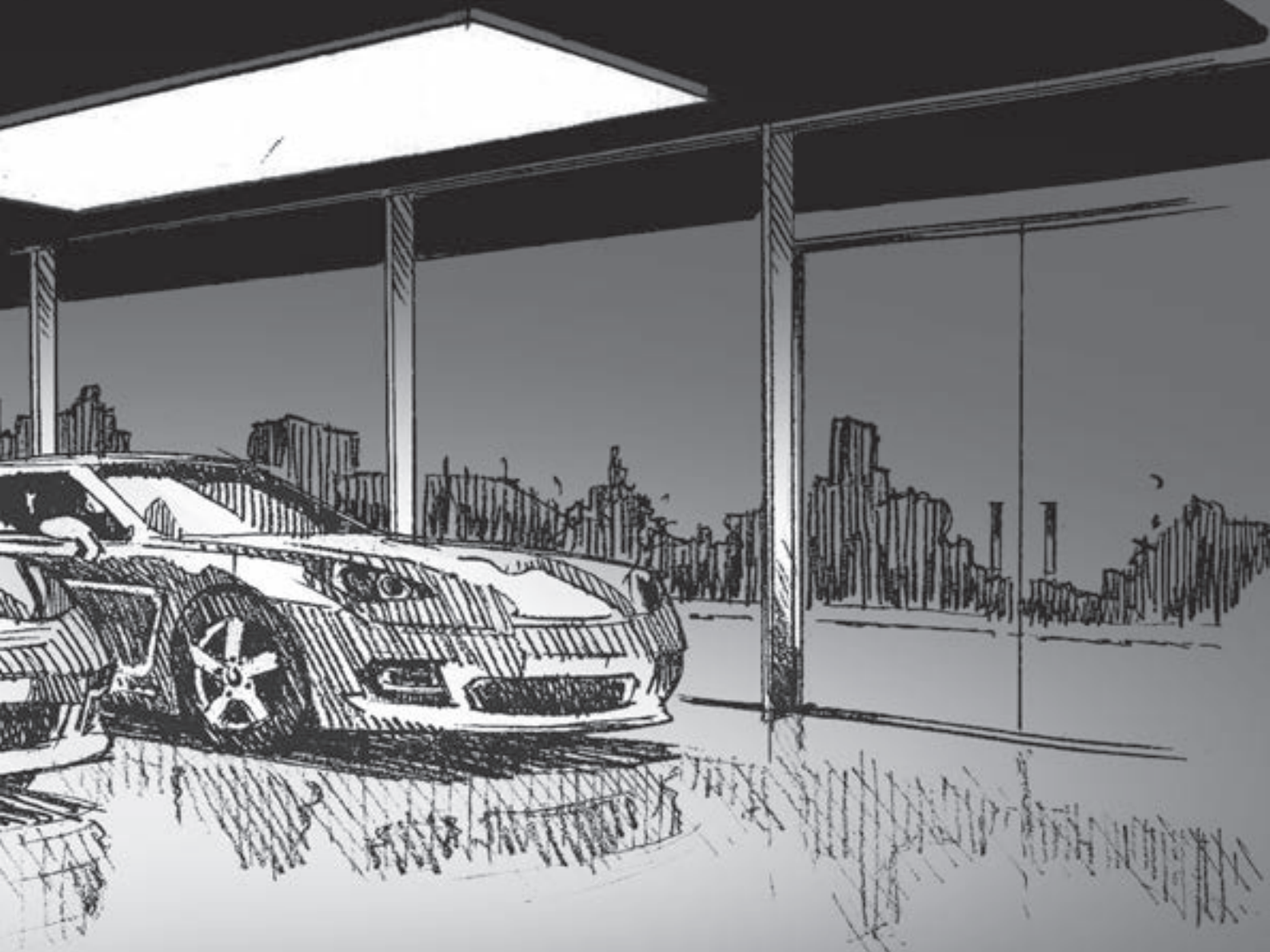









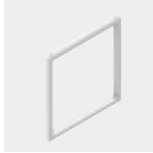

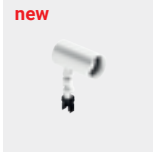



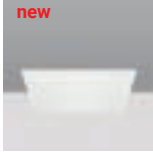

Ceiling and pendant lamps



ceiling and pendant lamps range index

Tour	Tour_R	Tour_Cell_C <i>new</i>	Tour_CD	Tour_CI	Tour_PD	Tour_PI	Tour_PU
							
	232	233	234	235	238	239	240
Tour	Tour_D	Tour_Cell_P <i>new</i>	Tour_Q	Tour_QV	Tour_QD	Tour_Track <i>new</i>	Tour_Projectors <i>new</i>
							
	241	242	244	244	245	246	246
Skylum	Skylum_Q <i>new</i>	Skylum_Q PRO <i>new</i>					
							
	254	255					
Pool	Pool_C	Pool_S	Pool_P				
							
	260	260	261				
Emy	Emy <i>new</i>						
							
	266						
Pound	Pound_S <i>new</i>	Pound_S Focus <i>new</i>	Pound_Wall <i>new</i>	Pound_Wall Focus <i>new</i>			
							
	272	272	273	273			
Cell	Cell_S	Cell_SWw <i>new</i>					
							
	277	277					

Baton

Baton_P



282

Baton_R



283

Baton_Q



283



tour

Matériaux
Structure en aluminium



tour range



	_R Recessed Direct	_Cell_C Cell Recessed	_CD Ceiling direct	_CI Ceiling Internal	_PD Pendant Direct	_PI Pendant Internal	_PU Pendant UP
29W	-	-	-	Ø 740 mm	-	Ø 750 mm	-
36,5W	-	-	-	Ø 910 mm	-	Ø 945 mm	-
37,5 W 38 W	Ø 745 mm	Ø 745 mm	Ø 740 mm	-	Ø 740 mm	-	Ø 740 mm
45 W 46 W	Ø 915 mm	Ø 915 mm	Ø 910 mm	-	Ø 910 mm	-	Ø 910 mm
57,5W	-	-	-	Ø 1430 mm	-	Ø 1475 mm	-
68 W 70 W	Ø 1435 mm	Ø 1435 mm	Ø 1430 mm	-	Ø 1430 mm	-	Ø 1430 mm
75W	-	-	-	-	-	-	-
90W	-	-	-	-	-	-	-
105W	-	-	-	-	-	-	-
114W	-	-	-	-	Ø 2450 mm	-	Ø 2450 mm
140W	-	-	-	-	-	-	-
180W	-	-	-	-	-	-	-
200W 210W	-	-	-	-	-	-	-
224W	-	-	-	-	-	-	-
Finish	<input type="checkbox"/> White <input type="checkbox"/> Black <input type="checkbox"/> Nickel <input type="checkbox"/> Gold <input type="checkbox"/> Bronze <input type="checkbox"/> Rosegold	<input type="checkbox"/> White	<input type="checkbox"/> White <input type="checkbox"/> Black <input type="checkbox"/> Nickel <input type="checkbox"/> Gold <input type="checkbox"/> Bronze <input type="checkbox"/> Rosegold	<input type="checkbox"/> White <input type="checkbox"/> Black <input type="checkbox"/> Nickel <input type="checkbox"/> Gold <input type="checkbox"/> Bronze <input type="checkbox"/> Rosegold	<input type="checkbox"/> White <input type="checkbox"/> Black <input type="checkbox"/> Nickel <input type="checkbox"/> Gold <input type="checkbox"/> Bronze <input type="checkbox"/> Rosegold	<input type="checkbox"/> White <input type="checkbox"/> Black <input type="checkbox"/> Nickel <input type="checkbox"/> Gold <input type="checkbox"/> Bronze <input type="checkbox"/> Rosegold	<input type="checkbox"/> White <input type="checkbox"/> Black <input type="checkbox"/> Nickel <input type="checkbox"/> Gold <input type="checkbox"/> Bronze <input type="checkbox"/> Rosegold
CRI 80	3000K - 4000K	2700K - 3000K 4000K	3000K - 4000K	3000K - 4000K	3000K - 4000K	3000K - 4000K	3000K - 4000K
CRI 90	-	-	-	-	-	-	-
Control	On/Off 0/1-10V DALI	On/Off 0/1-10V DALI	On/Off 0/1-10V DALI	On/Off 0/1-10V DALI	On/Off 0/1-10V DALI	On/Off 0/1-10V DALI	On/Off 0/1-10V DALI



	_D Double Emission	_Cell_P Cell Pendan	_Track Projectors	_Q Square	_QV Square Vertical	_QD Square Double
29W	-	-	-	-	-	-
36,5W	-	-	-	-	-	-
37,5 W 38 W	-	Ø 740 mm	-	-	-	-
45W	-	Ø 910 mm	-	655x655 mm	670x670 mm	-
57,5W	-	-	-	-	-	-
68 W 70 W	-	Ø 1430 mm	-	-	-	-
75W	Ø 740 mm	-	Ø 945 mm Ø 1475 mm	-	-	-
90W	Ø 910 mm	-	-	1255x1255 mm	-	657x657 mm
105W	-	-	-	1655x1255 mm	-	-
114W	-	-	-	-	-	-
140W	Ø 1430 mm	-	-	-	-	-
180W	-	-	-	-	-	1257x1257 mm
200W 210W	-	-	Ø 945 mm Ø 1475 mm	-	-	1657x1257 mm
224W	Ø 2450 mm	-	-	-	-	-
Finish	<input type="checkbox"/> White <input type="checkbox"/> Black <input type="checkbox"/> Nickel <input type="checkbox"/> Gold <input type="checkbox"/> Bronze <input type="checkbox"/> Rosegold	<input type="checkbox"/> White <input type="checkbox"/> Black	<input type="checkbox"/> White <input type="checkbox"/> Black	<input type="checkbox"/> White <input type="checkbox"/> Black	<input type="checkbox"/> White <input type="checkbox"/> Black	<input type="checkbox"/> White <input type="checkbox"/> Black
CRI 80	3000K - 4000K	2700K - 3000K 4000K	-	3000K - 4000K	3000K - 4000K	3000K - 4000K
CRI 90	-	-	2700K (15W - 22W) 3000K (15W - 22W) 4000K (15W - 22W)	-	-	-
Control	On/Off DALI	On/Off 0/1-10V DALI	On/Off	On/Off 0/1-10V DALI	On/Off 0/1-10V DALI	On/Off 0/1-10V DALI

Gamme d'émissions

2021 voit l'introduction, dans la famille Tour, de nouveaux modèles équipés de nouvelles optiques. Tour_Cell adopte des microcellules cut-off pour une émission générale sans éblouissement et un confort visuel très élevé ; Tour_Track permet, via l'accrochage de projecteurs spécifiques, d'obtenir une émission d'accentuation très polyvalente. Les nouvelles versions accompagnent les quatre émissions déjà connues, à savoir directe, indirecte, latérale interne et double : quatre effets de lumière qui peuvent être combinés entre eux pour former dans d'innombrables compositions capables de transformer les environnements avec une touche de lumière minimale et contemporaine.

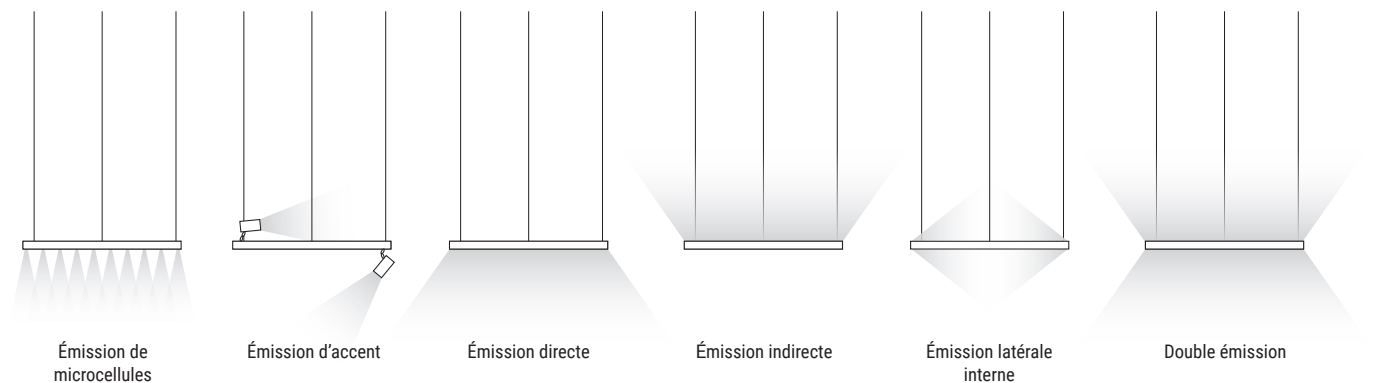

Cell Optics

Petits et ronds, les micro-réfecteurs à facettes convexes qui composent l'optique de Tour_Cell contrôlent efficacement la luminance. Associés à la source en retrait et à la cellule noire, ils garantissent un contrôle quasi total de l'éblouissement : il est en effet impossible de voir directement la source lumineuse, à moins de se placer en position zénithale par rapport à la lampe. Ceci garantit un confort visuel très élevé, ainsi qu'un éclairage général homogène, exempt de zones d'ombre ou de décoloration. Tour_Cell est disponible dans la version suspendue, minimale et élégante, ou encastrée, pour une installation en retrait qui préserve au maximum la propreté esthétique et architecturale.



Phonoabsorbant

Le système phonoabsorbant de Tour a été étudié pour garantir un maximum de confort sans rien ôter au facteur esthétique. Modèle distinctif de la gamme, Tour est disponible en trois couleurs et compatible avec les références : Tour_PD - Tour_PU - Tour_D - Tour_cell_P - Tour_Q - Tour_QD - Tour_CD. Facile et rapide à installer avec ses brides, il est extrêmement efficace.



Tour_projector

Tour_projector garantit des prestations élevées grâce à des projecteurs disponibles en deux dimensions : 15 W ø65 mm et 22 W ø85 mm. Les caractéristiques des deux projecteurs permettent à Tour_projector de mieux éclairer les boutiques et les musées en procurant une dynamique optimale, et de positionner les projecteurs sur l'ensemble de Tour_track sans porter atteinte à l'équilibre de la suspension.



Attache Easy Plug

Grâce à un système d'attache particulier, le projecteur peut être positionné sur toute la circonférence de Tour_track. En exploitant le nouveau système de blocage mécanique, Tour_projector garantit un maximum de sécurité et de stabilité en phase de mise au point.

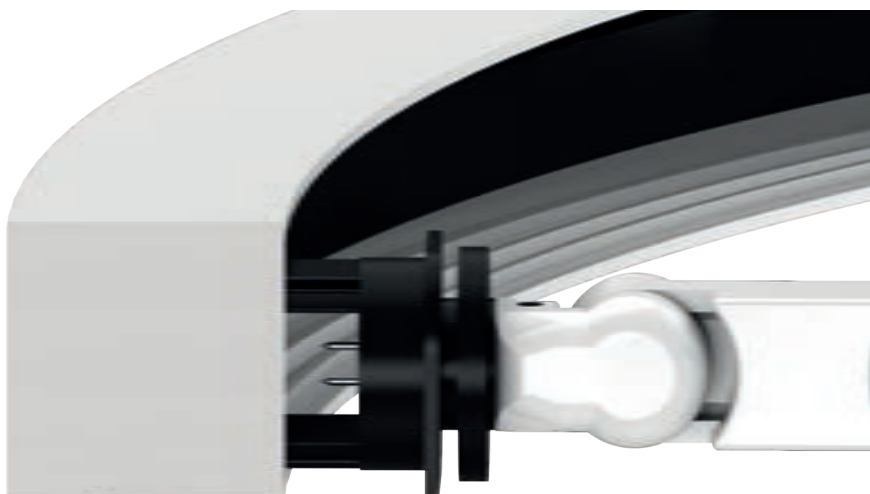

Accessoires pour le contrôle des émissions

Tour_projector est compatible avec une large gamme d'accessoires pour le contrôle du faisceau lumineux : masque diffuseur cylindrique standard et à 45°, pour supprimer tout ou partie du faisceau secondaire et réduire le cône lumineux ; déflecteur en croix et en nid d'abeille, pour contrôler et réduire l'éblouissement de forme plus ou moins marquée ; ailettes directionnelles et filtre elliptique, pour façonner la lumière ou créer des projections ovalisées.

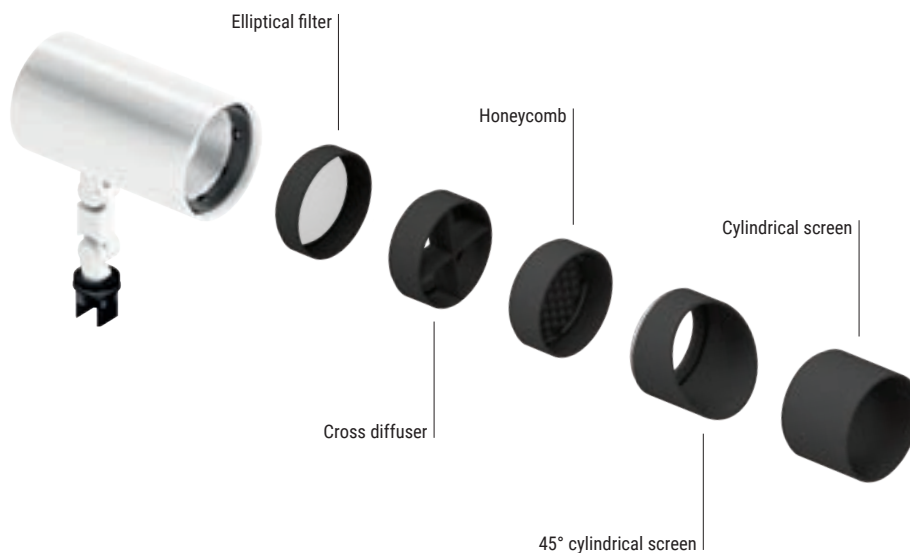

Tour_R | Integrated Luminaires | 24 V DC | topLED 37,5 W DC

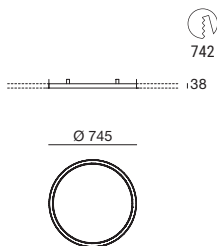

CRI 80	Cct	lm S - D	Optic
White 65420	W 3000	4678 - 2183	00 General (119°)
Black 65421	N 4000	5006 - 2335	
Nickel 65422			
Gold 63710			
Bronze 65424			
Rosegold 65425			

Électronique

99374	83018	99332	99722	83062
ON/OFF 1 - 2 art. p 210 x 148 x h 25	PUSH 1 - 2 art. p 210 x 149 x h 30	0/1-10V 1 - 4 art. p 150 x 160 x h 35	DALI 1 - 3 art. p 191 x 163 x h 38	DALI PUSH 1 - 4 art. p 210 x 149 x h 30

Tour_R | Integrated Luminaires | 24 V DC | topLED 45 W DC

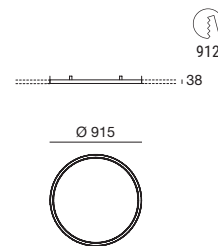

CRI 80	Cct	lm S - D	Optic
White 65426	W 3000	5847 - 2921	00 General (125°)
Black 65427	N 4000	6139 - 3067	
Nickel 65428			
Gold 63720			
Bronze 65430			
Rosegold 65431			

Électronique

99374	83018	99332	99722	83062
ON/OFF 1 art. p 210 x 148 x h 25	0/1-10V 1 - 3 art. p 210 x 149 x h 30	0/1-10V 1 - 3 art. p 150 x 160 x h 35	DALI 1 - 2 art. p 191 x 163 x h 38	DALI PUSH 1 - 3 art. p 43 x 1280 x h 30

Tour_R | Integrated Luminaires | 24 V DC | topLED 70 W DC

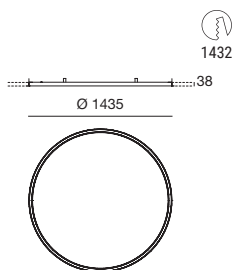

CRI 80	Cct	lm S - D	Optic
White 65432	W 3000	9355 - 4327	00 General (152°)
Black 65433	N 4000	9823 - 4542	
Nickel 65434			
Gold 63730			
Bronze 65436			
Rosegold 65437			

Électronique

99374	83018	99332	99722	83062
ON/OFF 1 art. p 210 x 148 x h 25	PUSH 1 - 2 art. p 150 x 160 x h 35	0/1-10V 1 - 2 art. p 150 x 160 x h 35	DALI 1 art. p 191 x 163 x h 38	DALI/PUSH 1 - 2 art. p 280 x 143 x h 30

Étapes de l'enlèvement de l'élément en EPS

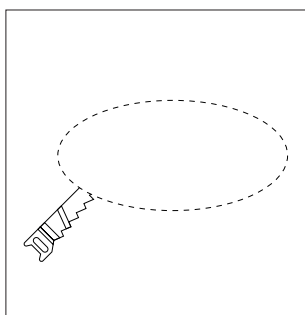

Section faux plafond

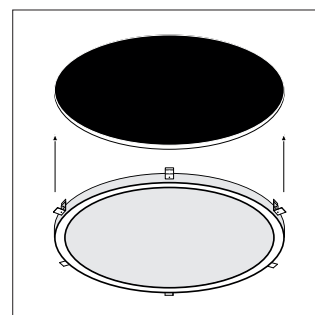

Insertion produit

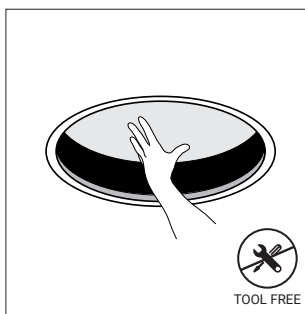

Retrait bouchon

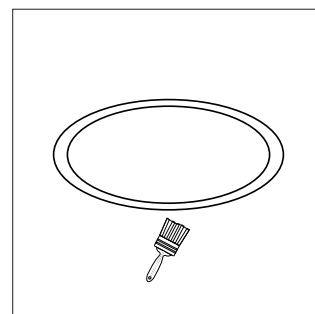

Peinture et positionnement bouchon

Tour_Cell_C | Integrated Luminaires | powerLED 38 W DC 600mA

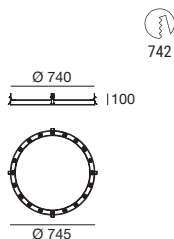

CRI 80	Cct	lm S - D	Optic
White	82727	M 2700 4380 - On req	30 Flood -
		W 3000 4660 - On req	45 W.Flood -
		N 4000 4980 - On req	

Électronique

83122	83120
ON/OFF 1 art. p 129 x 176 x h 30	0/1-10V DALI PUSH 1 art. p 124 x 179 x h 22

Tour_Cell_C | Integrated Luminaires | powerLED 46 W DC 600mA

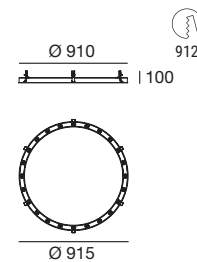

CRI 80	Cct	lm S - D	Optic
White	82264	M 2700 5256 - On req	30 Flood -
		W 3000 5592 - On req	45 W.Flood -
		N 4000 5976 - On req	

Électronique

83122	83120
ON/OFF 1 art. p 129 x 176 x h 30	0/1-10V DALI PUSH 1 art. p 124 x 179 x h 22

Tour_Cell_C | Integrated Luminaires | powerLED 68 W DC 550mA

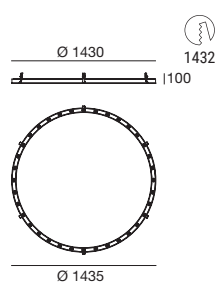

CRI 80	Cct	lm S - D	Optic
White	82265	M 2700 7884 - On req	30 Flood -
		W 3000 8388 - On req	45 W.Flood -
		N 4000 8964 - On req	

Électronique

83143	83121
ON/OFF PUSH 0/1-10V 1 art. p 124 x 179 x h 22	DALI 1 art. p 150 x 190 x h 38



Tour_CD | Ceiling Light | 24 V DC | topLED 37,5 W DC

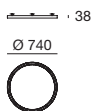

CRI 80	Cct	lm S - D	Optic
White 65350	W 3000	4678 - 2183	00 General (119°)
Black 65351	N 4000	5006 - 2335	
Nickel 65352			
Gold 63740			
Bronze 65354			
Rosegold 65355			

Électronique

99374	83018	99332	99722	83062
ON/OFF 1 - 2 art. p 210 x 148 x h 25	PUSH 1 - 2 art. p 210 x 149 x h 30	0/1-10V 1 - 4 art. p 150 x 160 x h 35	DALI 1 - 3 art. p 191 x 163 x h 38	DALI PUSH 1 - 4 art. p 210 x 149 x h 30

Tour_CD | Ceiling Light | 24 V DC | topLED 45 W DC

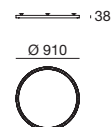

CRI 80	Cct	lm S - D	Optic
White 65356	W 3000	5847 - 2921	00 General (125°)
Black 65357	N 4000	6139 - 3067	
Nickel 65358			
Gold 63750			
Bronze 65360			
Rosegold 65361			

Électronique

99374	83018	99332	99722	83062
ON/OFF 1 art. p 210 x 148 x h 25	0/1-10V 1 - 3 art. p 210 x 149 x h 30	0/1-10V 1 - 3 art. p 150 x 160 x h 35	DALI 1 - 2 art. p 191 x 163 x h 38	DALI PUSH 1 - 3 art. p 43 x 1280 x h 30

Tour_CD | Ceiling Light | 24 V DC | topLED 70 W DC

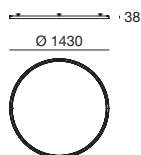

CRI 80	Cct	lm S - D	Optic
White 65362	W 3000	9355 - 4327	00 General (152°)
Black 65363	N 4000	9823 - 4542	
Nickel 65364			
Gold 63760			
Bronze 65366			
Rosegold 65367			

Électronique

99374	83018	99332	99722	83062
ON/OFF 1 art. p 210 x 148 x h 25	PUSH 1 - 2 art. p 150 x 160 x h 35	0/1-10V 1 - 2 art. p 150 x 160 x h 35	DALI 1 art. p 191 x 163 x h 38	DALI/PUSH 1 - 2 art. p 280 x 143 x h 30

Kit entretoises pour Tour_CD

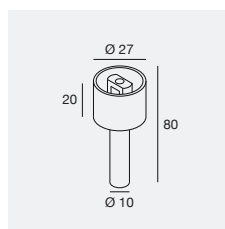

White 65386
Black 65387
Nickel 65389
Gold 63724
Bronze 65390
Rosegold 65391



La version Tour_C est fournie avec des entretoises de 23 mm.

Tour_CI | Ceiling_Wall Light | 24 V DC | stripLED 29 W DC

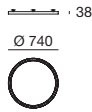

CRI 80	Cct	lm S - D	Optic
White 65368	W 3000	3000 - 1212	00 General (175°)
Black 65369	N 4000	3220 - 1297	
Nickel 65370			
Gold 63721			
Bronze 65372			
Rosegold 65373			

Électronique

99374	83018	99332	99722	83062
ON/OFF 1 - 2 art.	PUSH 1 - 2 art.	0/1-10V 1 - 5 art.	DALI 1 - 4 art.	DALI PUSH 1 - 5 art.
p 210 x 148 x h 25	p 210 x 149 x h 30	p 150 x 160 x h 35	p 191 x 163 x h 38	p 210 x 149 x h 30

Tour_CI | Ceiling_Wall Light | 24 V DC | stripLED 36,5 W DC

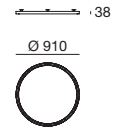

CRI 80	Cct	lm S - D	Optic
White 65374	W 3000	3783 - 1568	00 General (174°)
Black 65375	N 4000	4060 - 1682	
Nickel 65376			
Gold 63722			
Bronze 65378			
Rosegold 65379			

Électronique

99374	83018	99332	99722	83062
ON/OFF 1 - 2 art.	PUSH 1 - 2 art.	0/1-10V 1 - 4 art.	DALI 1 - 3 art.	DALI PUSH 1 - 4 art.
p 210 x 148 x h 25	p 210 x 149 x h 30	p 150 x 160 x h 35	p 191 x 163 x h 38	p 210 x 149 x h 30

Tour_CI | Ceiling_Wall Light | 24 V DC | stripLED 57,5 W DC

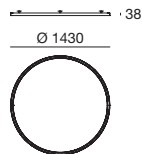

CRI 80	Cct	lm S - D	Optic
White 65380	W 3000	6000 - 2369	00 General (174°)
Black 65381	N 4000	6440 - 2542	
Nickel 65382			
Gold 63723			
Bronze 65384			
Rosegold 65385			

Électronique

99374	83018	99332	99722	83062
ON/OFF 1 art.	PUSH 1 - 2 art.	0/1-10V 1 - 2 art.	DALI 1 - 2 art.	DALI PUSH 1 - 2 art.
p 210 x 148 x h 25	p 210 x 149 x h 30	p 150 x 160 x h 35	p 191 x 163 x h 38	p 280 x 143 x h 30

Kit entretoises pour Tour_CI

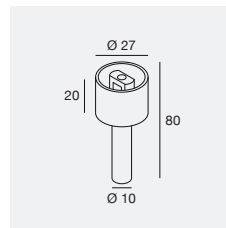

White 65386
Black 65387
Nickel 65389
Gold 63724
Bronze 65390
Rosegold 65391

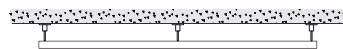

La version Tour_C est fournie avec des entretoises de 23 mm.

Configuration Tour_C avec kit entretoises

Réalisation d'une composition ON/OFF. Tour_CI, CD avec kit d'entretoises. Tour_C est fourni avec des entretoises de 23 mm qui peuvent être remplacées par le kit de suspension pour augmenter la distance par rapport au plafond.

Sélection modèle Tour

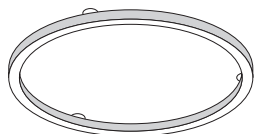

Sélection kit suspension



Sélection driver/contrôleur

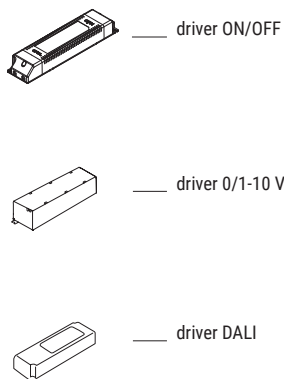

Résultat final

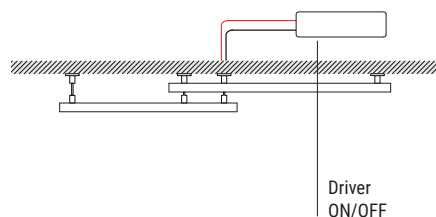

Exemple de ordination :

n.1 art. 65368W00 + n.1 art. 65386 (spacer kit) + n.1 art. 99374 (driver ON/OFF)
 n.1 art. 65356W00

Configuration Tour à encastrement

Réalisation d'une composition ON/OFF avec Tour_R.

Sélection modèle Tour

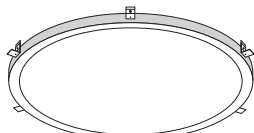

Sélection driver/contrôleur

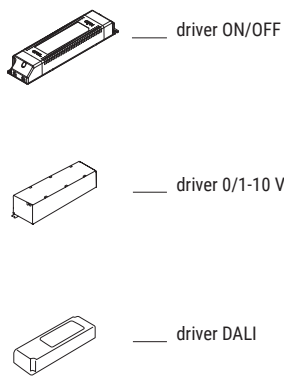

Résultat final

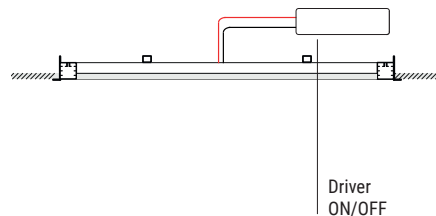

Exemple de ordination :

n.1 art. 65420W00 + n.1 art. 99374 (driver ON/OFF)



Tour_PD | Pendant Luminaire | 24 V DC | topLED 37,5 W DC

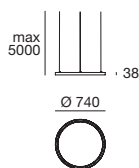

CRI 80	Cct	lm S - D	Optic
White 64570	W 3000	4678 - 2183	00 General (119°)
Black 65112	N 4000	5006 - 2335	
Nickel 65113			
Gold 63726			
Bronze 65115			
Rosegold 65128			

Électronique

99374	83018	99332	99722	83062
ON/OFF 1 - 2 art. p 210 x l 148 x h 25	PUSH 1 - 2 art. p 210 x l 149 x h 30	0/1-10V 1 - 4 art. p 150 x l 60 x h 35	DALI 1 - 3 art. p 191 x l 63 x h 38	DALI PUSH 1 - 4 art. p 210 x l 149 x h 30

Accessoires Pag. 248/249

RTG 64570W00 / 65112W00

Tour_PD | Pendant Luminaire | 24 V DC | topLED 70 W DC

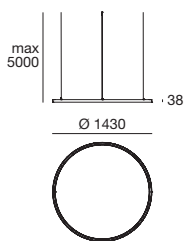

CRI 80	Cct	lm S - D	Optic
White 64572	W 3000	9355 - 4327	00 General (152°)
Black 65120	N 4000	9823 - 4542	
Nickel 65121			
Gold 63728			
Bronze 65123			
Rosegold 65130			

Électronique

99374	83018	99332	99722	83062
ON/OFF 1 art. p 210 x l 148 x h 25	PUSH 1 - 2 art. p 150 x l 60 x h 35	0/1-10V 1 - 2 art. p 150 x l 60 x h 35	DALI 1 art. p 191 x l 63 x h 38	DALI/PUSH 1 - 2 art. p 280 x l 143 x h 30

Accessoires Pag. 248/249

RTG 64572W00 / 64572N00 / 65120W00 / 65120N00

Tour_PD | Pendant Luminaire | 24 V DC | topLED 45 W DC

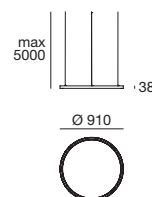

CRI 80	Cct	lm S - D	Optic
White 64571	W 3000	5847 - 2921	00 General (125°)
Black 65116	N 4000	6139 - 3067	
Nickel 65117			
Gold 63727			
Bronze 65119			
Rosegold 65129			

Électronique

99374	83018	99332	99722	83062
ON/OFF 1 art. p 210 x l 148 x h 25	0/1-10V 1 - 3 art. p 210 x l 149 x h 30	0/1-10V 1 - 3 art. p 150 x l 60 x h 35	DALI 1 - 2 art. p 191 x l 63 x h 38	DALI PUSH 1 - 3 art. p 43 x l 280 x h 30

Accessoires Pag. 248/249

RTG 64571W00 / 65116W00

Tour_PD | Pendant Luminaire | 24 V DC | topLED 114 W DC

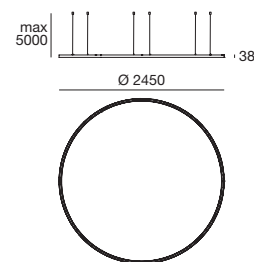

CRI 80	Cct	lm S - D	Optic
White 64573	W 3000	15588 - 7210	00 General (152°)
Black 65124	N 4000	16367 - 7551	
Nickel 65125			
Gold 63729			
Bronze 65127			
Rosegold 65131			

Électronique

99331	83019	99332	99722	83062
ON/OFF 1 art. p 150 x l 60 x h 35	PUSH 1 - 2 art. p 150 x l 60 x h 35	0/1-10V 1 art. p 150 x l 60 x h 35	DALI 1 art. p 191 x l 63 x h 38	DALI / PUSH 1 art. p 280 x l 143 x h 30

Accessoires Pag. 248/249

RTG 64573W00 / 64573N00 / 65124W00 / 65124N00

Tour_PI | Pendant Luminaire | 24 V DC | stripLED 29 W DC

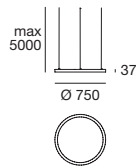

CRI 80	Cct	lm S - D	Optic
White 64577	W 3000	3000 - 1212	00 General (175°)
Black 65100	N 4000	3220 - 1297	
Nickel 65101			
Gold 63736			
Bronze 65103			
Rosegold 65132			

Électronique

99374	83018	99332	99722	83062
ON/OFF 1 - 2 art. p 210 x 148 x h 25	PUSH 1 - 2 art. p 210 x 149 x h 30	0/1-10V 1 - 5 art. p 150 x 160 x h 35	DALI 1 - 4 art. p 191 x 163 x h 38	DALI PUSH 1 - 5 art. p 210 x 149 x h 30

Accessoires Pag. 248/249

Tour_PI | Pendant Luminaire | 24 V DC | stripLED 36,5 W DC

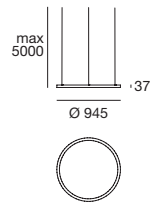

CRI 80	Cct	lm S - D	Optic
White 64579	W 3000	3785 - 1568	00 General (174°)
Black 65104	N 4000	4060 - 1682	
Nickel 65105			
Gold 63737			
Bronze 65107			
Rosegold 65133			

Électronique

99374	83018	99332	99722	83062
ON/OFF 1 - 2 art. p 210 x 148 x h 25	PUSH 1 - 2 art. p 210 x 149 x h 30	0/1-10V 1 - 4 art. p 150 x 160 x h 35	DALI 1 - 3 art. p 191 x 163 x h 38	DALI PUSH 1 - 4 art. p 210 x 149 x h 30

Accessoires Pag. 248/249

Tour_PI | Pendant Luminaire | 24 V DC | stripLED 57,5 W DC

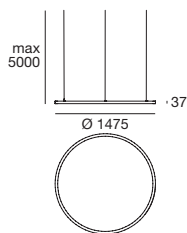

CRI 80	Cct	lm S - D	Optic
White 64581	W 3000	6000 - 2369	00 General (174°)
Black 65108	N 4000	6440 - 2542	
Nickel 65109			
Gold 63738			
Bronze 65111			
Rosegold 65134			

Électronique

99374	83018	99332	99722	83062
ON/OFF 1 art. p 210 x 148 x h 25	PUSH 1 - 2 art. p 210 x 149 x h 30	0/1-10V 1 - 2 art. p 150 x 160 x h 35	DALI 1 - 2 art. p 191 x 163 x h 38	DALI PUSH 1 - 2 art. p 280 x 143 x h 30

Accessoires Pag. 248/249

Tour_PU | Pendant Luminaire | 24 V DC | topLED 37,5 W DC

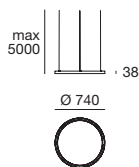

CRI 80	Cct	lm S - D	Optic
White 64583	W 3000	4678 - 2183	00 General (119°)
Black 64682	N 4000	5006 - 2340	
Nickel 64683			
Gold 63731			
Bronze 64685			
Rosegold 65135			

Électronique

99374	83018	99332	99722	83062
ON/OFF 1 - 2 art. p 210 x 148 x h 25	PUSH 1 - 2 art. p 210 x 149 x h 30	0/1-10V 1 - 4 art. p 150 x 160 x h 35	DALI 1 - 3 art. p 191 x 163 x h 38	DALI PUSH 1 - 4 art. p 210 x 149 x h 30

Accessoires Pag. 248/249

Tour_PU | Pendant Luminaire | 24 V DC | topLED 45 W DC

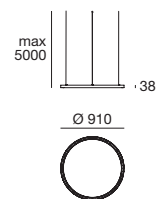

CRI 80	Cct	lm S - D	Optic
White 64584	W 3000	5847 - 2921	00 General (125°)
Black 64686	N 4000	6139 - 3066	
Nickel 64687			
Gold 63732			
Bronze 64689			
Rosegold 65136			

Électronique

99374	83018	99332	99722	83062
ON/OFF 1 art. p 210 x 148 x h 25	0/1-10V 1 - 3 art. p 210 x 149 x h 30	0/1-10V 1 - 3 art. p 150 x 160 x h 35	DALI 1 - 2 art. p 191 x 163 x h 38	DALI PUSH 1 - 3 art. p 43 x 1280 x h 30

Accessoires Pag. 248/249

Tour_PU | Pendant Luminaire | 24 V DC | topLED 70 W DC

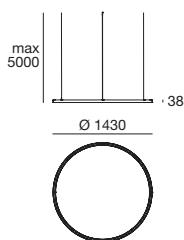

CRI 80	Cct	lm S - D	Optic
White 64585	W 3000	9355 - 4327	00 General (152°)
Black 64690	N 4000	9823 - 4542	
Nickel 64691			
Gold 63733			
Bronze 64693			
Rosegold 65137			

Électronique

99374	83018	99332	99722	83062
ON/OFF 1 art. p 210 x 148 x h 25	PUSH 1 - 2 art. p 150 x 160 x h 35	0/1-10V 1 - 2 art. p 150 x 160 x h 35	DALI 1 art. p 191 x 163 x h 38	DALI/PUSH 1 - 2 art. p 280 x 143 x h 30

Accessoires Pag. 248/249

Tour_PU | Pendant Luminaire | 24 V DC | topLED 114 W DC

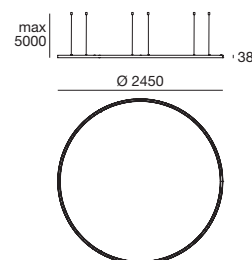

CRI 80	Cct	lm S - D	Optic
White 64587	W 3000	15588 - 7210	00 General (152°)
Black 64694	N 4000	16367 - 7571	
Nickel 64695			
Gold 63734			
Bronze 64697			
Rosegold 65138			

Électronique

99331	83019	99332	99722	83062
ON/OFF 1 art. p 150 x 160 x h 35	PUSH 1 - 2 art. p 150 x 160 x h 35	0/1-10V 1 art. p 150 x 160 x h 35	DALI 1 art. p 191 x 163 x h 38	DALI / PUSH 1 art. p 280 x 143 x h 30

Accessoires Pag. 248/249

Tour_D | Pendant Luminaire | 24 V DC | topLED 75 W DC

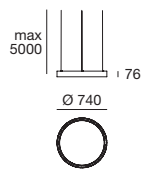

CRI 80	Cct	lm S - D	Optic
White 65300	W 3000	9356 - 4364	00 General (119°)
Black 65301	N 4000	10012 - 4669	
Nickel 65302			
Gold 63711			
Bronze 65304			
Rosegold 65305			

Électronique

99374	83018	99332	99722	83062
ON/OFF 1 art. p 210 x 148 x h 25	PUSH 1 - 2 art. p 150 x 160 x h 35	0/1-10V 1 - 2 art. p 150 x 160 x h 35	DALI 1 art. p 191 x 163 x h 38	DALI/PUSH 1 - 2 art. p 280 x 143 x h 30

Accessoires Pag. 248/249

Tour_D | Pendant Luminaire | 24 V DC | topLED 90 W DC

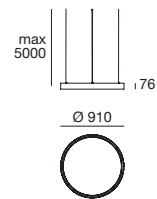
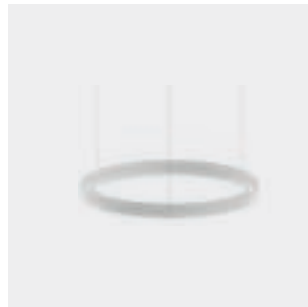

CRI 80	Cct	lm S - D	Optic
White 65306	W 3000	11694 - 5841	00 General (125°)
Black 65307	N 4000	12278 - 6128	
Nickel 65308			
Gold 63712			
Bronze 65310			
Rosegold 65311			

Électronique

99331	83019	99332	99722	83062
ON/OFF 1 art. p 150 x 160 x h 35	PUSH 1 - 2 art. p 150 x 160 x h 35	0/1-10V 1 art. p 150 x 160 x h 35	DALI 1 art. p 191 x 163 x h 38	DALI / PUSH 1 art. p 280 x 143 x h 30

Accessoires Pag. 248/249

Tour_D | Pendant Luminaire | 24 V DC | topLED 140 W DC

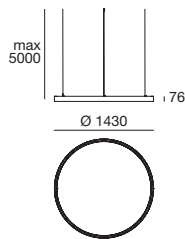

CRI 80	Cct	lm S - D	Optic
White 65312	W 3000	18710 - 8655	00 General (152°)
Black 65313	N 4000	19646 - 9084	
Nickel 65314			
Gold 63713			
Bronze 65316			
Rosegold 65317			

Électronique

99331	83019	99332	99787	83062
ON/OFF 1 art. p 150 x 160 x h 35	Push 1 art. p 150 x 160 x h 35	0/1-10V 1 art. p 150 x 160 x h 35	DALI 1 art. p 220 x 171 x h 38	DALI / Push 1 art. p 280 x 143 x h 30

Accessoires Pag. 248/249

Tour_D | Pendant Luminaire | 24 V DC | topLED 224 W DC

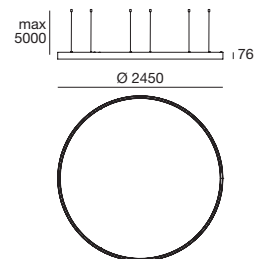

CRI 80	Cct	lm S - D	Optic
White 65318	W 3000	31176 - 14421	00 General (152°)
Black 65319	N 4000	32724 - 15101	
Nickel 65320			
Gold 63714			
Bronze 65322			
Rosegold 65323			

Électronique

99786	99787
ON/OFF 1 art. p 220 x 171 x h 18	DALI 1 art. p 220 x 171 x h 18

Accessoires Pag. 248/249

Tour_Cell_P | Pendant Luminaire | powerLED 38 W DC 630mA

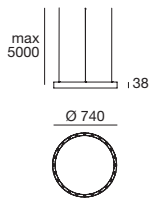

CRI 80	Cct	lm S - D	Optic
White 82725	M 2700	4380 - On req	30 Flood -
Black 82726	W 3000	4660 - On req	45 W.Flood -
	N 4000	4980 - On req	

Électronique

83122	83120
ON/OFF 1 art. p 129 x 176 x h 30	0/1-10V DALI PUSH 1 art. p 124 x 179 x h 22

Accessoires Pag. 248/249

Tour_Cell_P | Pendant Luminaire | powerLED 46 W DC 630mA

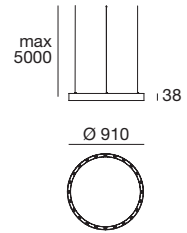

CRI 80	Cct	lm S - D	Optic
White 82298	M 2700	5256 - On req	30 Flood -
Black 82299	W 3000	5592 - On req	45 W.Flood -
	N 4000	5976 - On req	

Électronique

83122	83120
ON/OFF 1 art. p 129 x 176 x h 30	0/1-10V DALI PUSH 1 art. p 124 x 179 x h 22

Accessoires Pag. 248/249

Tour_Cell_P | Pendant Luminaire | powerLED 68 W DC 630mA

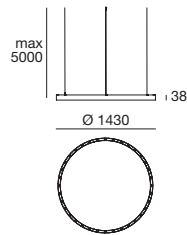

CRI 80	Cct	lm S - D	Optic
White 82300	M 2700	7884 - On req	30 Flood -
Black 82301	W 3000	8388 - On req	45 W.Flood -
	N 4000	8964 - On req	

Électronique

83143	83121
ON/OFF PUSH 0/1-10V 1 art. p 124 x 179 x h 22	DALI 1 art. p 150 x 190 x h 38

Accessoires Pag. 248/249



Tour_Q | Pendant Luminaire | 24 V DC | topLED 45 W DC

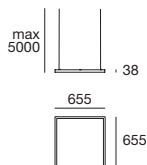

CRI 80	Cct	lm S - D	Optic
White 64360	W 3000	4810 - 2200	00 General (123°)
Black 64370	N 4000	5040 - 2306	

Électronique

99374	83018	99332	99722	83062
ON/OFF 1 art. p 210 x 148 x h 25	0/1-10V 1-3 art. p 210 x 149 x h 30	0/1-10V 1-3 art. p 150 x 160 x h 35	DALI 1-2 art. p 191 x 163 x h 38	DALI PUSH 1-3 art. p 43 x 1280 x h 30

Accessoires Pag. 248/249

Tour_Q | Pendant Luminaire | 24 V DC | topLED 90 W DC

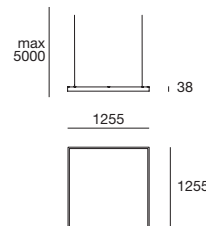

CRI 80	Cct	lm S - D	Optic
White 64361	W 3000	9619 - 4403	00 General (123°)
Black 64371	N 4000	10080 - 4615	

Électronique

99331	83019	99332	99722	83062
ON/OFF 1 art. p 150 x 160 x h 35	PUSH 1-2 art. p 150 x 160 x h 35	0/1-10V 1 art. p 150 x 160 x h 35	DALI 1 art. p 191 x 163 x h 38	DALI / PUSH 1 art. p 280 x 143 x h 30

Accessoires Pag. 248/249

Tour_Q | Pendant Luminaire | 24 V DC | topLED 105 W DC

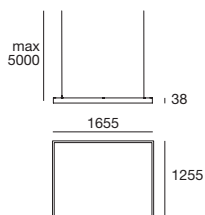

CRI 80	Cct	lm S - D	Optic
White 64362	W 3000	11223 - 5139	00 General (123°)
Black 64372	N 4000	11760 - 5386	

Électronique

99331	83019	99332	99722	83062
ON/OFF 1 art. p 150 x 160 x h 35	PUSH 1-2 art. p 150 x 160 x h 35	0/1-10V 1 art. p 150 x 160 x h 35	DALI 1 art. p 191 x 163 x h 38	DALI / PUSH 1 art. p 280 x 143 x h 30

Accessoires Pag. 248/249

Tour_QV | Pendant Luminaire | 24 V DC | topLED 45 W DC

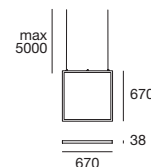
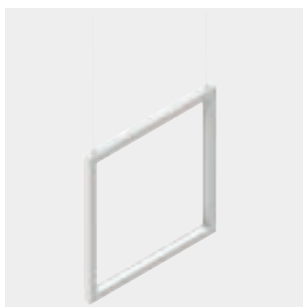

CRI 80	Cct	lm S - D	Optic
White 64260	W 3000	4810 - 2347	00 General (175°)
Black 64250	N 4000	5040 - 2460	

Électronique

99374	83018	99332	99722	83062
ON/OFF 1 art. p 210 x 148 x h 25	0/1-10V 1-3 art. p 210 x 149 x h 30	0/1-10V 1-3 art. p 150 x 160 x h 35	DALI 1-2 art. p 191 x 163 x h 38	DALI PUSH 1-3 art. p 43 x 1280 x h 30

Accessoires Pag. 248/249

Tour_QD | Pendant Luminaires | 24 V DC | topLED 90 W DC

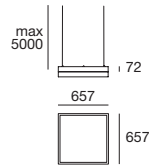

CRI 80	Cct	lm S - D	Optic
White 64363	W 3000	9620 - 4397	00 General (123°)
Black 64373	N 4000	10080 - 4609	

Électronique

99331	83019	99332	99722	83062
ON/OFF 1 art. p 150 x 160 x h 35	PUSH 1 - 2 art. p 150 x 160 x h 35	0/1-10V 1 art. p 150 x 160 x h 35	DALI 1 art. p 191 x 163 x h 38	DALI / PUSH 1 art. p 280 x 143 x h 30

Accessoires Pag. 248/249

Tour_QD | Pendant Luminaires | 24 V DC | topLED 180 W DC

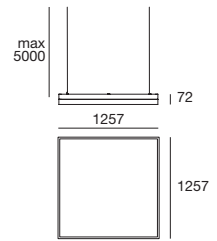

CRI 80	Cct	lm S - D	Optic
White 64364	W 3000	18437 - 8805	00 General (123°)
Black 64374	N 4000	19320 - 9014	

Électronique

99786	99787
ON/OFF 1 art. p 220 x 171 x h 18	DALI 1 art. p 220 x 171 x h 18

Accessoires Pag. 248/249

Tour_QD | Pendant Luminaires | 24 V DC | topLED 210 W DC

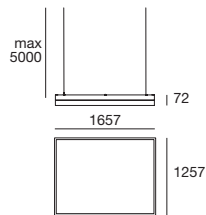

CRI 80	Cct	lm S - D	Optic
White 64365	W 3000	22446 - 10337	00 General (123°)
Black 64375	N 4000	23520 - 10827	

Électronique

99786	99787
ON/OFF 1 art. p 220 x 171 x h 18	DALI 1 art. p 220 x 171 x h 18

Accessoires Pag. 248/249

Tour_Track | Pendant Luminaires | 48 V DC

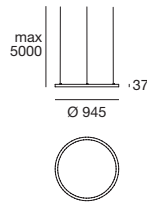

White	82753
Black	82755

Accessoires Pag. 248/249

Tour_Track | Pendant Luminaires | 48 V DC

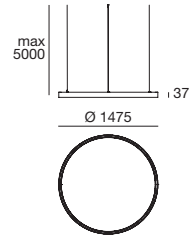

White	82754
Black	82756

Accessoires Pag. 248/249

Tour_Projectors | Pendant Luminaires | 48 V DC | arrayLED 15 W DC

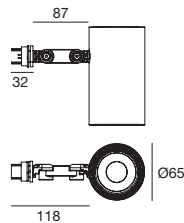

Balance - CRI 90	Cct	lm S - D	Optic
White 82757	M 2700	1748 - On req	15 Spot -
Black 82758	W 3000	1830 - On req	30 Flood -
	N 4000	1967 - On req	60 W.Flood -

Optiques & accessoires Pag. 247

Tour_Projectors | Pendant Luminaires | 48 V DC | arrayLED 22 W DC

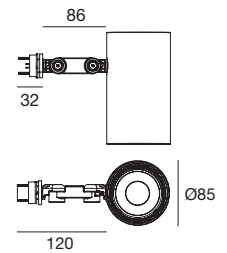

Balance - CRI 90	Cct	lm S - D	Optic
White 82759	M 2700	2648 - On req	15 Spot -
Black 82760	W 3000	2774 - On req	30 Flood -
	N 4000	2982 - On req	60 W.Flood -

Optiques & accessoires Pag. 247

Optiques



description	
99827	Spot
suitable for: Tour_Projectors 15W	



description	
99828	Flood
suitable for: Tour_Projectors 15W	



description	
99829	Wide Flood
suitable for: Tour_Projectors 15W	

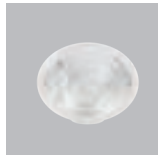

description	
99808	Spot
suitable for: Tour_Projectors 22W	



description	
99809	Flood
suitable for: Tour_Projectors 22W	



description	
99810	Wide Flood
suitable for: Tour_Projectors 22W	

Accessoires



description	
99781	Filtre elliptique
suitable for: Tour_Projectors 15W	

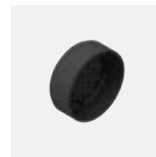

description	
99780	Honeycomb
suitable for: Tour_Projectors 15W	

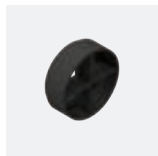

description	
99779	Défecteur en croix
suitable for: Tour_Projectors 15W	



description	
99783	Écran cylindrique
suitable for: Tour_Projectors 15W	



description	
99782	Écran cylindrique 45°
suitable for: Tour_Projectors 15W	



description	
99797	Filtre elliptique
suitable for: Tour_Projectors 22W	



description	
99798	Honeycomb
suitable for: Tour_Projectors 22W	

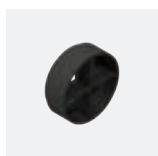

description	
99799	Défecteur en croix
suitable for: Tour_Projectors 22W	



description	
99796	Écran cylindrique
suitable for: Tour_Projectors 22W	



description	
99795	Écran cylindrique 45°
suitable for: Tour_Projectors 22W	

Rosace à 3 points

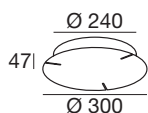

Tour PD - PI - PU simple émission

Ø 740 mm - Ø 910 mm - Ø 1430 mm

ON/OFF
Max 75 W

White 64578

Black 65142

Nickel 65144

Gold 63706

Bronze 65148

Rosegold 65150

DALI 0/1-10 V
Max 75 W

White 64586

Black 65143

Nickel 65145

Gold 63707

Bronze 65149

Rosegold 65151

Tour D double émission

Ø 740 mm - Ø 910 mm - Ø 1430 mm

ON/OFF
Max 75+75 W

White 65324

Black 65326

Nickel 65328

Gold 63701

Bronze 65332

Rosegold 65334

DALI 0/1-10V
Max 75+75 W

White 65325

Black 65327

Nickel 65329

Gold 63702

Bronze 65333

Rosegold 65335

Rosace à 6 points

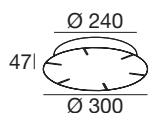

Tour PD - PI - PU simple émission

Ø 2450 mm

ON/OFF
Max 150 W

White 64580

Black 65152

Nickel 65154

Gold 63708

Bronze 65158

Rosegold 65160

DALI
Max 150 W

White 64588

Black 65153

Nickel 65155

Gold 63709

Bronze 65159

Rosegold 65161

Tour D double émission

Ø 2450 mm

ON/OFF
Max 150+150 W

White 65336

Black 65338

Nickel 65340

Gold 63703

Bronze 65344

Rosegold 65346

DALI 0/1-10V
Max 150+150 W

White 65337

Black 65339

Nickel 65341

Gold 63704

Bronze 65345

Rosegold 65347

Rosace 6 points pour fixation 3 Tour

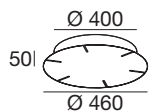

ON/OFF
Max 450 W

White 65412

Black 65413

Nickel 65414

Gold 63716

Bronze 65416

Rosegold 65417

DALI
Max 450 W

White 65418

Black 65419

Nickel 65398

Gold 63717

Bronze 65349

Rosegold 65399

Rosace de fixation pour Tour_Cell_P

Ø 740 mm - Ø 910 mm
Ø 1430 mm

ON/OFF
75 W

White 63778

Black 63779

Ø 740 mm - Ø 910 mm

DALI
75 W

White 63788

Black 63789

Ø 1430 mm

DALI
75 W

White 63798

Black 63799

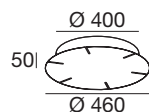
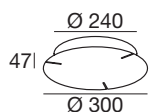

Ø 945 mm - Ø 1475 mm

ON/OFF
75 W

White 63782

Black 63783

Ø 945 mm - Ø 1475 mm

ON/OFF
200 W

White 63772

Black 63773

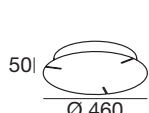
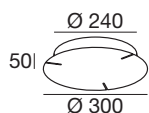

Rosace de fixation pour Tour Q simple émission

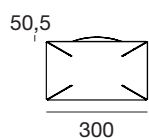

ON/OFF
Max 75 W

White **64368**

Black **64369**

DALI 0/1-10 V
Max 75 W

White **64388**

Black **64389**

ON/OFF
Max 150 W

White **64378**

Black **64379**

DALI 0/1-10 V
Max 150 W

White **64398**

Black **64399**

Rosace de fixation pour Tour Q double émission

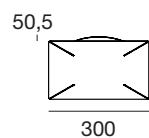

ON/OFF
Max 75 W + 75 W

White **64358**

Black **64359**

DALI 0/1-10 V
Max 75 W + 75 W

White **64348**

Black **64349**

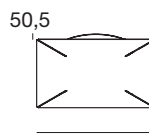

ON/OFF
Max 150 W + 150 W

White **64338**

Black **64339**

DALI 0/1 -10 V
Max 150 W + 150 W

White **64328**

Black **64329**

Kit de fixation à 3 Tour_R

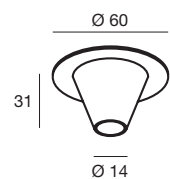

White **64575**

Black **64670**

Nickel **64671**

Gold **63700**

Bronze **64673**

Rosegold **65141**

La version Ø 2450 nécessite 2 kits de fixation à 3 cônes chacun.

RTG 64575 / 64670

Kit de fixation à 4 Tour_Q

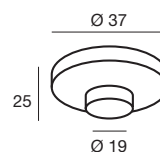

type

White **64270**

Black **64240**

Panneaux d'absorption acoustique

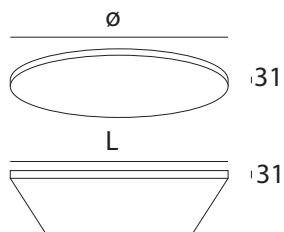
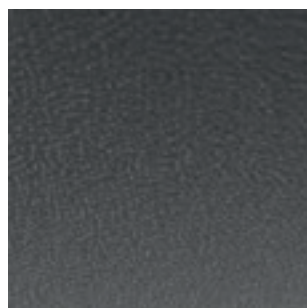

		Ø mm	L mm
Grey	99957	Ø 665	579x579
Anthracite	99958	Ø 665	579x579
Black	99959	Ø 665	579x579
Grey	99954	Ø 835	1179x1179
Anthracite	99955	Ø 835	1179x1179
Black	99956	Ø 835	1179x1179
Grey	99960	579x579	1179x1579
Anthracite	99961	579x579	1179x1579
Black	99962	579x579	1179x1579
Grey	99963	1179x1179	1179x1579
Anthracite	99964	1179x1179	1179x1579
Black	99965	1179x1179	1179x1579
Grey	99966	1179x1579	1179x1579
Anthracite	99967	1179x1579	1179x1579
Black	99968	1179x1579	1179x1579

Pag. 248

RTG 64578 / 65142 / 64586 / 65143

RTG 64580 / 65152 / 64588 / 65153

Ceiling and pendant lamps



skylum

Matériaux

Corps en aluminium

Diffuseur en tissu polyester blanc opalin

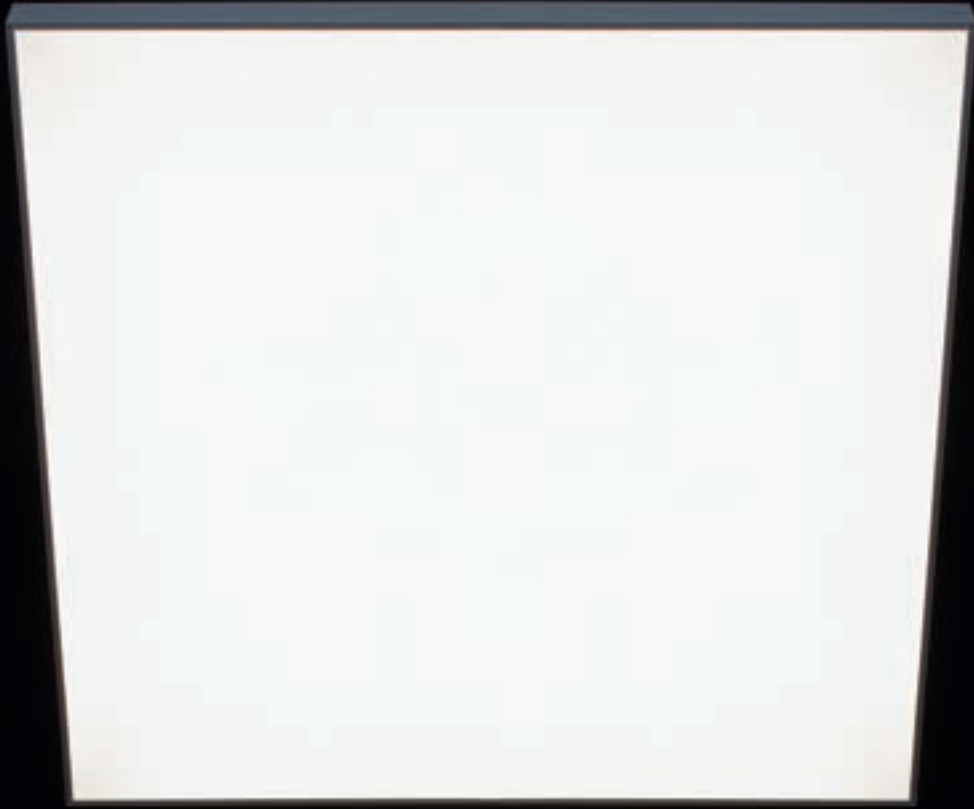

Haute diffusion lumineuse

Skylum est un système haute définition. La grande surface illuminée de manière totalement homogène en tous points, sans retombées ni angles morts, parfaitement verticale au niveau du sol efface totalement les ombres horizontales, est caractérisée par un diffuseur en polyester coupe-feu de classe B1 conforme à la norme DIN 4102-1, facilement retirable et lavable en machine à 30 °C.

Standard version



56,5mm

Pro version



100mm

Micro-optiques



Skylum, une lumière pure diffusée

Skylum est un système d'éclairage diffus disponible en deux versions : Standard et PRO aux multiples possibilités de combinaisons et de compositions. Dans des dimensions prédéfinies ou étudiées sur mesure, Skylum éclaire idéalement les magasins ou les grands espaces ouverts, tels que les aéroports et les hôtels. Le système garantit une parfaite homogénéité de la lumière en effaçant les ombres au sol et en améliorant le confort.

82260

7 m x 7 m x 3 h

valeurs calculées avec des coefficients de réflexion :

sol 20

mur 50

plafond 70

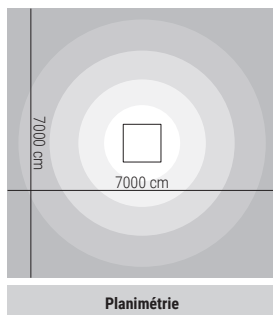

Planimétrie



NO SHADOWS



Versions Standard

La version Standard est constituée d'un châssis en aluminium léger très fin de 56,5 mm d'épaisseur, disponible en trois dimensions, 620 x 620, 935 x 935, 1 250 x 1 250 mm, dans lequel sont répartis les circuits à LED. Des micro-optiques spéciales sont montées pour chaque diode en garantissant l'uniformité malgré la hauteur réduite de la chambre de réflexion.

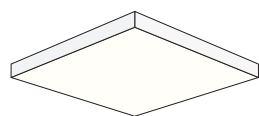

82258

620 mm x 620 mm x h: 56,5 mm

38 W DC - 43 W AC

3000 K - 6557 lm

4000 K - 6794 lm

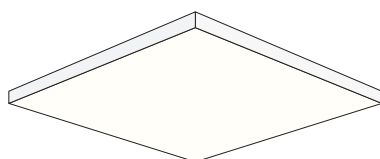

82259

935 mm x 935 mm x h: 56,5 mm

96 W DC - 101 W AC

3000 K - 16400 lm

4000 K - 17000 lm

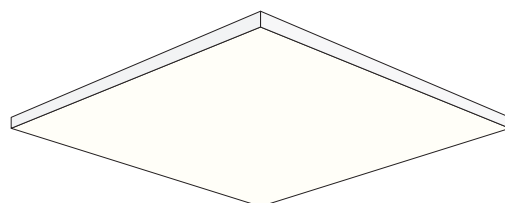

82260

1250 mm x 1250 mm x h: 56,5 mm

159,6 W DC - 169 W AC

3000 K - 29890 lm

4000 K - 30983 lm

Version PRO

Dans la version PRO, le châssis mesure 100 mm d'épaisseur et se présente dans deux dimensions fixes : 1 500 x 500 et 1 500 x 1 500 ; les deux modèles contiennent des sources LED modulaires qui se prêtent à la personnalisation des dimensions ou adoptent deux formes limitées : carrée (max. 1 920 x 1 920 mm) et rectangulaire (max. 5 800 x 1 480 mm). Le châssis de la structure aux bords très fins rend imperceptible le rapprochement des modules, pour des structures lumineuses toujours originales.

Mod.A
480 mm x 480 mm
4000 K: **3298 lm**

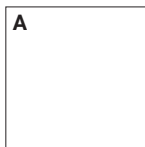

Mod.B
120 mm x 160 mm
4000 K: **275 lm**



Frame
20 mm x 20 mm

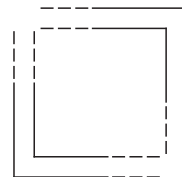

Es:
2 Mod.A x 12 Mod. B

960 mm x 760 mm
4000 K: **9896 lm**

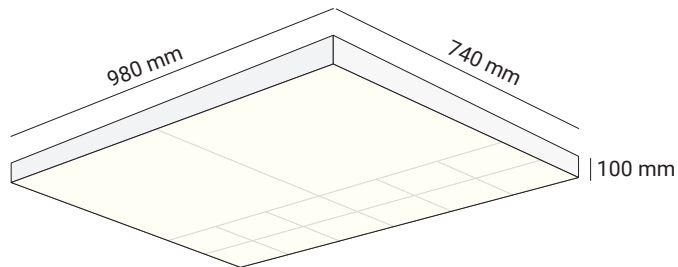
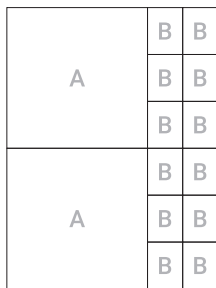

Es:
1 Mod.A x 18 Mod. B

800 mm x 720 mm
4000 K: **8248 lm**

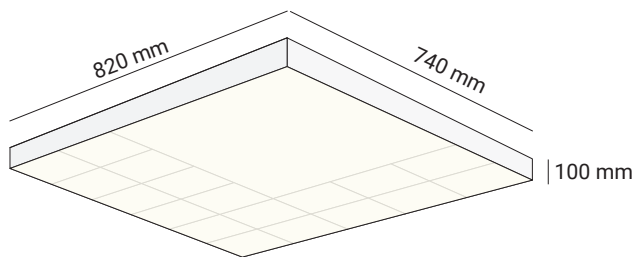
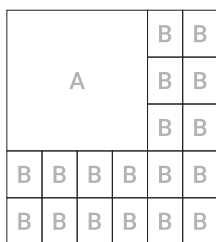

Es:
1 Mod.A x 12 Mod. B

800 mm x 600 mm
4000 K: **6598 lm**

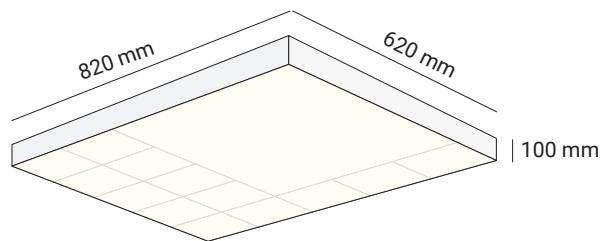
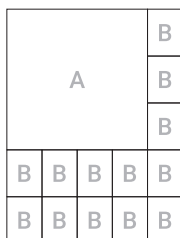

Es:
1 Mod.A x 8 Mod. B

480 mm x 800 mm
4000 K: **5498 lm**

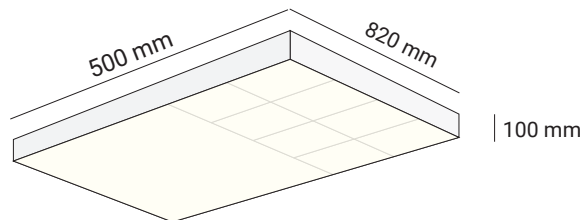

MAX:
12 Mod.A x 3 Mod. A

5780 mm x 1460 mm
4000 K: **118728 lm**

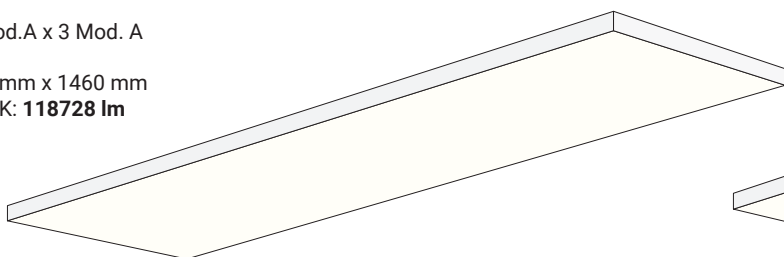

MAX:
4 Mod.A x 4 Mod. A

1940 mm x 1940 mm
4000 K: **52768 lm**

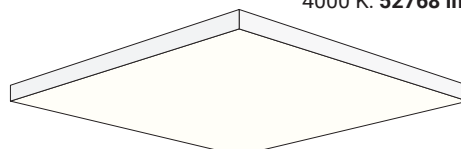

Skylum_Q | Ceiling Lights | 100-240 V AC | topLED 38W DC - 43 W AC

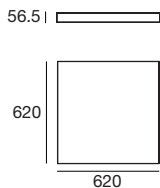

CRI 80	Cct	lm S - D	Optic
White 82258	W 3000	6557 - On req	00 General -
Black 84273	N 4000	6794 - On req	

CRI 80 - DALI	Cct	lm S - D	Optic
White 82261	W 3000	6557 - On req	00 General -
Black 84276	N 4000	6794 - On req	

Available from April 2021

Skylum_Q | Ceiling Lights | 220-240 V AC | topLED 96W DC - 104 W AC

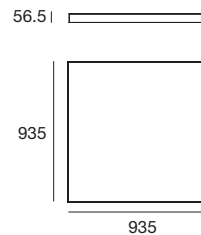

CRI 80	Cct	lm S - D	Optic
White 82259	W 3000	16400 - On req	00 General -
Black 84274	N 4000	17000 - On req	

CRI 80 - DALI	Cct	lm S - D	Optic
White 82262	W 3000	16400 - On req	00 General -
Black 84277	N 4000	17000 - On req	

Available from April 2021

Skylum_Q | Ceiling Lights | 220-240 V AC | topLED 160W DC - 172 W AC

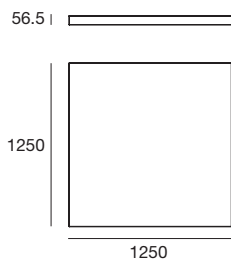

CRI 80	Cct	lm S - D	Optic
White 82260	W 3000	29890 - On req	00 General -
Black 84275	N 4000	30983 - On req	

CRI 80 - DALI	Cct	lm S - D	Optic
White 82263	W 3000	29890 - On req	00 General -
Black 84278	N 4000	30983 - On req	

Available from April 2021

Skylum_Q PRO | Ceiling Lights | 100-240 V AC | topLED 78 W DC

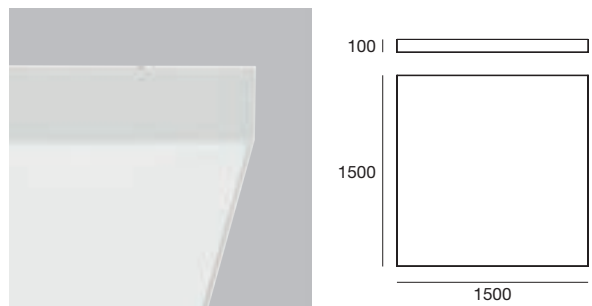

CRI 80 - DALI	Cct	lm S - D	Optic
White 84170	W 3000	14904 - On req	00 General -
Black 84271	N 4000	15426 - On req	

Électronique
83195

DALI
1 art.
p 180 x 163 x h 36

Available from April 2021

Skylum_Q PRO | Ceiling Lights | 220-240 V AC | topLED 157 W DC

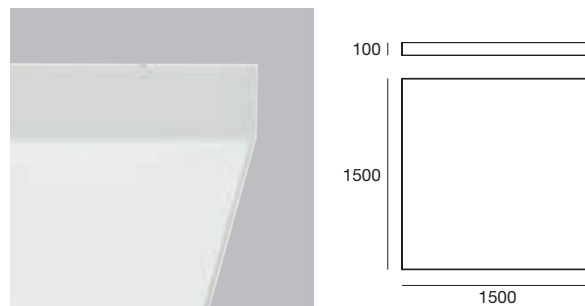

CRI 80 - DALI	Cct	lm S - D	Optic
White 84171	W 3000	28638 - On req	00 General -
Black 84272	N 4000	29682 - On req	

Électronique
83196

DALI
1 art.
p 244 x 171 x h 38

Available from April 2021

Skylum_Q PRO | Ceiling Lights | 100-240 V AC | topLED 52 W DC



CRI 80 - DALI	Cct	lm S - D	Optic
White 84169	W 3000	9546 - On req	00 General -
Black 84270	N 4000	9894 - On req	

Électronique
83196

DALI
1 art.
p 180 x 163 x h 36

Available from April 2021



pool

Matériaux

Corps en aluminium

Diffuseur en polycarbonate opalin



pool range



	_C Recessed	_P Pendant	_S Surface
20W	Ø 353 mm	-	Ø 352 mm
60W	Ø 652 mm	Ø 652 mm	Ø 652 mm
120W	Ø 952 mm	Ø 952 mm	Ø 952 mm
Finish	White	White	White
CRI 80	3000K - 4000K	3000K - 4000K	3000K - 4000K
Optics	General	General	General
Control	On/Off - DALI	On/Off - DALI	On/Off - DALI

Décorer avec lumière

La technologie d'éclairage s'allie à la précision du design. Le confort visuel prend une forme rationnelle, créant un effet artistique avec la simplicité de sa géométrie pure.

Versions DALI

La gamme Pool est disponible dans les versions encastrée, en saillie et suspendue, avec protocole de variation DALI. Étant donné la grande taille des luminaires et les puissances globales considérables pouvant être atteintes, il est fondamental d'opter pour la polyvalence des solutions DALI qui simplifient considérablement la gestion des différents paramètres de l'éclairage.

Épaisseur réduite

Application à fleur de plafond

Homogénéité de lumière parfaite

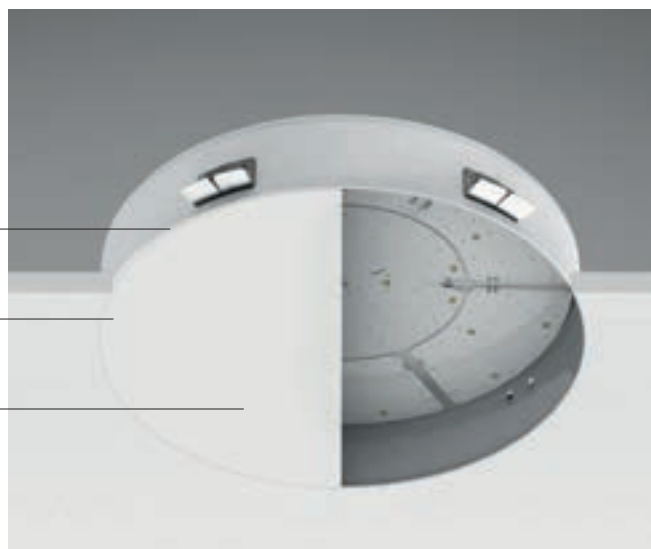

Installation multiple

Pool propose une gamme répondant à tout besoin en matière de conception ; quel que soit le type d'installation requis (montage à encastrement, en saillie ou en suspension) le corps disparaît complètement, tandis que le diffuseur fin en polycarbonate assure une faible luminance qui se traduit par une lumière douce et confortable ; dans sa version circulaire périphérique, ce même diffuseur se métamorphose en un cercle de lumière fascinant.

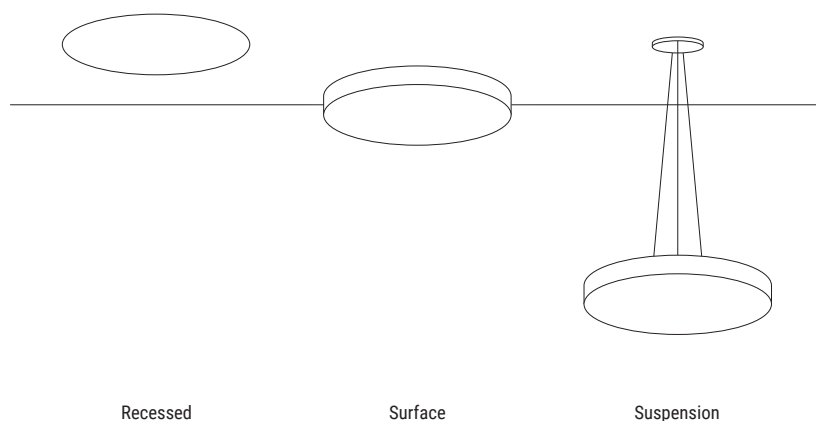

Émission contrôlée

Le diffuseur en polycarbonate opalin garantit un contrôle total du flux lumineux, permettant de mélanger et de diriger les photons émis par la source lumineuse dépourvue de lentilles ou de filtres. Il en résulte un effet visuel confortable : la lumière paraît douce et diffuse.

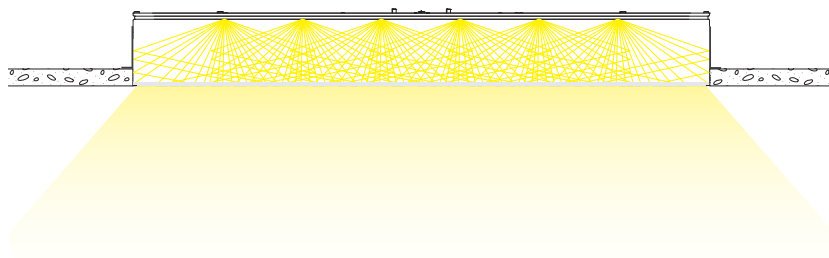

Pool_C | Recessed lights | 220-240 V AC | topLED 20 W DC - 24 W AC

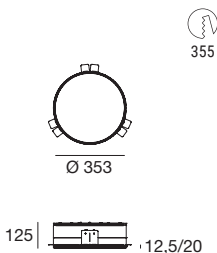

CRI 80	Cct	lm S - D	Optic
White 62931	W 3000	2730 - 1751	00 General (103°)
	N 4000	2925 - 1876	

DALI - CRI 80	Cct	lm S - D	Optic
White 62934	W 3000	2730 - 1751	00 General (103°)
	N 4000	2925 - 1876	

Pool_C | Recessed lights | 220-240 V AC | topLED 60 W DC - 66 W AC

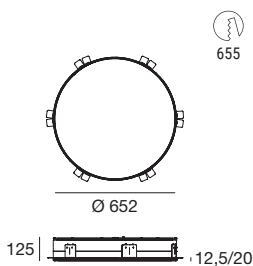

CRI 80	Cct	lm S - D	Optic
White 62932	W 3000	8190 - 6121	00 General (110°)
	N 4000	8775 - 6558	

DALI - CRI 80	Cct	lm S - D	Optic
White 62935	W 3000	8190 - 6121	00 General (110°)
	N 4000	8775 - 6558	

Pool_C | Recessed lights | 220-240 V AC | topLED 120 W DC - 131 W AC

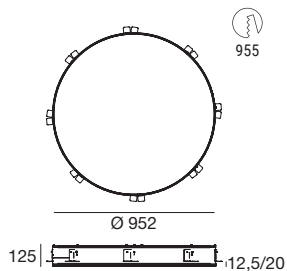

CRI 80	Cct	lm S - D	Optic
White 62933	W 3000	16380 - 12279	00 General (110°)
	N 4000	17550 - 13156	

DALI - CRI 80	Cct	lm S - D	Optic
White 62936	W 3000	16380 - 12279	00 General (110°)
	N 4000	17550 - 13156	

Pool_S | Ceiling Lights | 100-240 V AC | topLED 20 W DC - 24 W AC

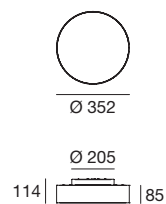

CRI 80	Cct	lm S - D	Optic
White 62911	W 3000	2730 - 1751	00 General (104°)
	N 4000	2925 - 1876	

DALI - CRI 80	Cct	lm S - D	Optic
White 62923	W 3000	2730 - 1751	00 General (104°)
	N 4000	2925 - 1876	

Pool_S | Ceiling Lights | 220-240 V AC | topLED 60 W DC - 66 W AC

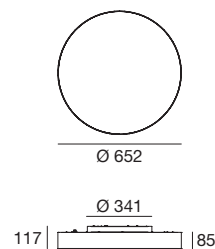

CRI 80	Cct	lm S - D	Optic
White 62912	W 3000	8190 - 6121	00 General (110°)
	N 4000	8775 - 6558	

DALI - CRI 80	Cct	lm S - D	Optic
White 62922	W 3000	8190 - 6121	00 General (110°)
	N 4000	8775 - 6558	

Pool_S | Ceiling Lights | 220-240 V AC | topLED 120 W DC - 131 W AC

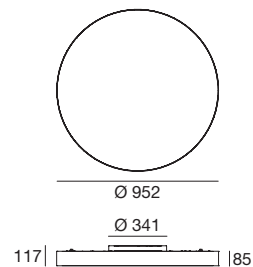

CRI 80	Cct	lm S - D	Optic
White 62915	W 3000	16380 - 12279	00 General (110°)
	N 4000	17550 - 13156	

DALI - CRI 80	Cct	lm S - D	Optic
White 62925	W 3000	16380 - 12279	00 General (110°)
	N 4000	17550 - 13156	

Pool_P | Pendant Luminaires | 220-240 V AC | topLED 60 W DC - 66 W AC

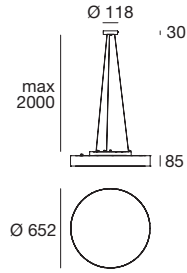

CRI 80	Cct	lm S - D	Optic
White	62916	W 3000 N 4000	00 General (110°)
		8190 - 6121 8775 - 6558	

DALI - CRI 80	Cct	lm S - D	Optic
White	62926	W 3000 N 4000	00 General (110°)
		8190 - 6121 8775 - 6558	

Pool_P | Pendant Luminaires | 220-240 V AC | topLED 120 W DC - 131 W AC

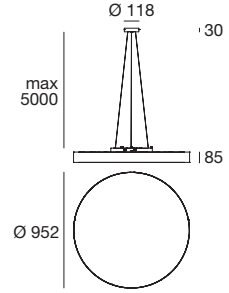

CRI 80	Cct	lm S - D	Optic
White	62921	W 3000 N 4000	00 General (110°)
		16380 - 12279 17550 - 13156	

Ekipe Sporting Center | Catania, Italy



Ceiling and pendant lamps







emy

Matériaux

Corps en aluminium

Diffuseur en PMMA microprismatique

Détails de construction

Dalle extra fin, d'une épaisseur de 9 mm seulement. Grâce au micro-prisme spécial du diffuseur, l'éclairage est lumineux et confortable, avec un indice de rendu des couleurs élevé (CRI90). L'éblouissement est réduit, avec des valeurs UGR<19.

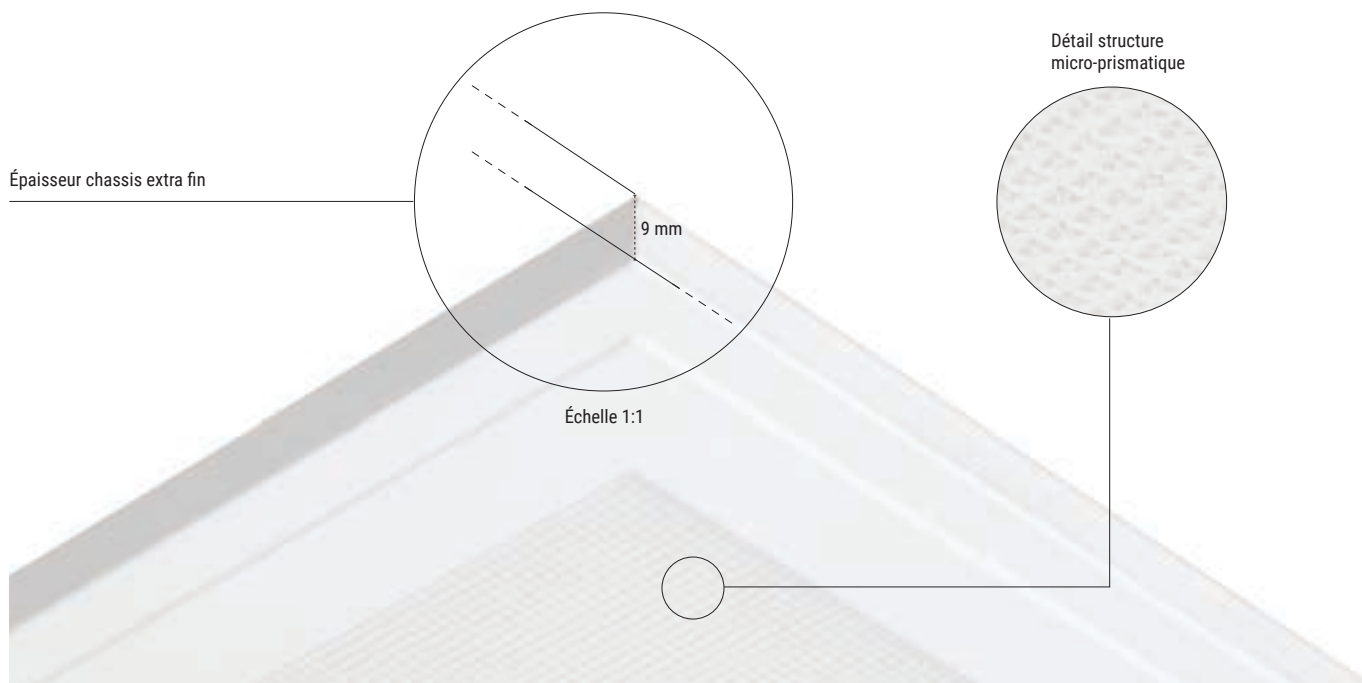

Installation rapide

Structure en aluminium peint en blanc. Dimensions réduites pour une installation pratique. Le pilote est inclus dans l'article avec câble et connecteur rapide «Easy Plug». Connexion simple et rapide en deux points.

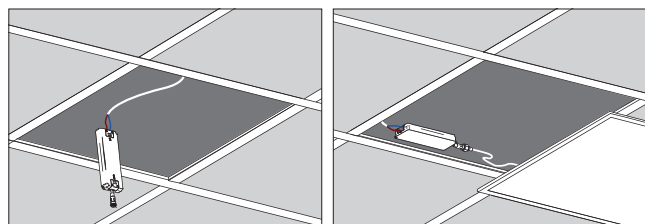

1. Connexion du driver au secteur.

2. Connexion Driver-Emy via connecteur rapide «Easy Plug».

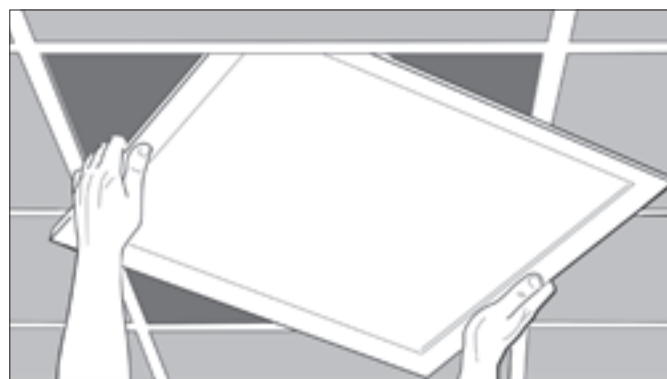

Installation en appui sur le châssis du faux plafond modulaire

au plafond ou en suspension

Accessoires disponibles sur demande : cadre pour installation au plafond et kit avec attaches et câbles pour installation en suspension.

Plafond

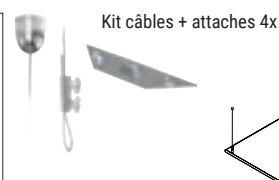

Emy | Ceiling lights | topLED | 40W DC Max 1200mA

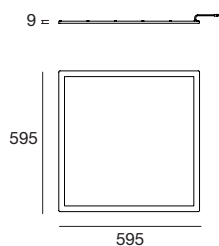

CRI 90	Cct	lm S - D	Optic
White 82831	W 3000 N 4000	On req On req	00 General -

Accessoires Pag. 266

RTG 82831N00 / 82831W00

Emy | Ceiling lights | 220-240 V AC | topLED | 40W AC

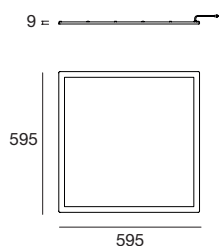

CRI 90	Cct	lm S - D	Optic
White 82832	N 4000	4000 - On req	00 General -

Accessoires Pag. 266

RTG 82832N00

Emy | Ceiling lights | topLED | 40W DC Max 1200mA

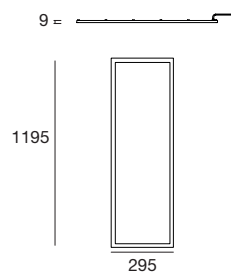





CRI 90	Cct	lm S - D	Optic
White 82833	W 3000 N 4000	4000 - On req 4000 - On req	00 General. -

Accessoires Pag. 266

RTG 82833N00 / 82833W00

Accessoires

	description
	99584 Suspension cables 4 pz. suitable for: Emy
	99556 Surface frame 595x595 suitable for: Emy
	99898 Surface frame 1195x295 suitable for: Emy
	99970 Driver ON/OFF 135x45x25 - 1 art suitable for: Emy 40W (IP20)
	99971 Driver DALI 112x64x30 - 1 art suitable for: Emy 40W (IP20)

RTG 99584 / 99556 / 99898 / 99970 / 99971



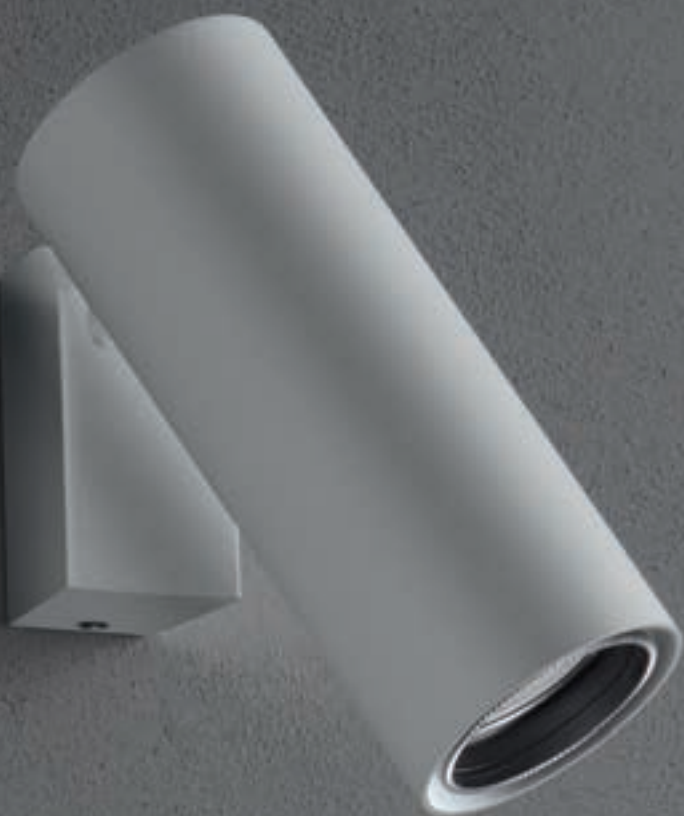

pound

Matériaux
Corps en aluminium



Large gamme

Pound_S est disponible en quatre versions : plafonnier, plafonnier à focale variable. Équipés d'un driver embarqué et disponibles dans les finitions noir et blanc, les modèles Pound_S permettent de s'affranchir du système sur rail tout en conservant les points forts de la gamme Pound. La dernière nouveauté concerne les Pound_Wall, conçus pour s'adapter à toutes situations grâce à leur nouvelle articulation qui permet d'orienter le produit sur un axe vertical de 90 ° et sur un axe horizontal de 350 °.



Plafonnier dynamique

L'éclairage ponctuel par le haut de Pound_S permet de souligner de manière optimale les œuvres exposées sur mur ou tout autre objet à mettre en valeur. La polyvalence des modèles Pound_S Focus, à focale réglable.

Plafonnier lenticulaire

Pour offrir le meilleur contrôle possible de la mise au point tout en garantissant un éclairage de qualité extrême, Pound_S Focus intègre un système optique spécial composé d'une lentille en verre mobile. Le coulisement fait varier l'angle d'ouverture du faisceau de la source. La plage de réglage s'étend d'un angle très étroit à un angle particulièrement large.

La bague graduée focus-on-board permet de régler l'angle d'ouverture du faisceau de 15° à 60°, ce qui rend l'orientation simple et précise. Le système de verrouillage de l'angle d'ouverture, facile à utiliser, permet d'obtenir une ouverture correspondant à l'angle sélectionné sur la bague.





Pound_S | Projectors | 190-250 V AC | arrayLED 6,5 W DC - 8,5 W AC

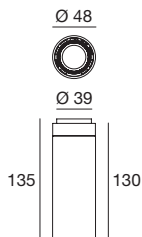

Balance - CRI 92		Cct	lm S - D	Optic
White	82003	M 2700	621 - On req	15 Spot -
Black	82004	W 3000	665 - On req	30 Flood -
		N 4000	718 - On req	60 W.Flood -

Optiques & accessoires Pag. 274/275

Pound_S | Projectors | 190-250 V AC | arrayLED 17,5 W DC - 19,5 W AC

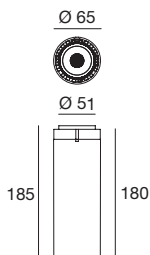

Balance - CRI 92		Cct	lm S - D	Optic
White	82005	M 2700	1939 - On req	15 Spot -
Black	82006	W 3000	2030 - On req	30 Flood -
		N 4000	2182 - On req	60 W.Flood -

Optiques & accessoires Pag. 274/275

Pound_S | Projectors | 190-250 V AC | arrayLED 26 W DC - 29 W AC

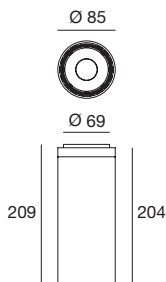

Balance - CRI 92		Cct	lm S - D	Optic
White	82007	M 2700	3220 - On req	15 Spot -
Black	82008	W 3000	3373 - On req	30 Flood -
		N 4000	3626 - On req	60 W.Flood -

Optiques & accessoires Pag. 274/275

Pound_S Focus | Projectors | 190-250 V AC | arrayLED 6,5 W DC - 8,5 W AC

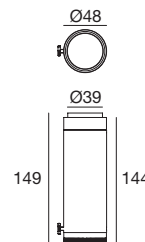

Balance - CRI 92		Cct	lm S - D	Optic
White	82063	M 2700	621 - On req	85 15° - 60°
Black	82064	W 3000	665 - On req	
		N 4000	718 - On req	

Optiques & accessoires Pag. 274/275

Pound_S Focus | Projectors | 190-250 V AC | arrayLED 17,5 W DC - 19,5 W AC

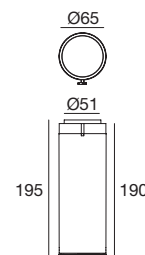

Balance - CRI 92		Cct	lm S - D	Optic
White	82065	M 2700	1939 - On req	85 15° - 60°
Black	82066	W 3000	2030 - On req	
		N 4000	2182 - On req	

Optiques & accessoires Pag. 274/275

Pound_S Focus | Projectors | 190-250 V AC | arrayLED 24,5 W DC - 27,5 W AC

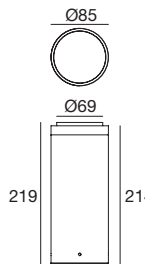

Balance - CRI 92		Cct	lm S - D	Optic
White	82067	M 2700	3033 - On req	85 15° - 60°
Black	82068	W 3000	3177 - On req	
		N 4000	3416 - On req	

Optiques & accessoires Pag. 274/275

Pound_Wall | Projectors | 190-250 V AC | arrayLED 6,5 W DC - 8,5 W AC

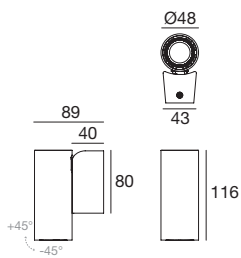

Balance - CRI 92		Cct	lm S - D	Optic
White	81995	M 2700	621 - On req	15 Spot -
Black	81996	W 3000	665 - On req	30 Flood -
		N 4000	718 - On req	60 W.Flood -

Optiques & accessoires Pag. 274/275

Pound_Wall | Projectors | 190-250 V AC | arrayLED 17,5 W DC - 19,5 W AC

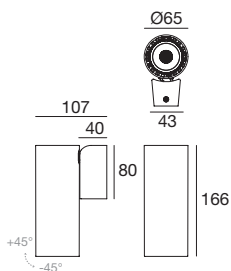

Balance - CRI 92		Cct	lm S - D	Optic
White	81997	M 2700	1939 - On req	15 Spot -
Black	81998	W 3000	2030 - On req	30 Flood -
		N 4000	2182 - On req	60 W.Flood -

Optiques & accessoires Pag. 274/275

Pound_Wall | Projectors | 190-250 V AC | arrayLED 26 W DC - 29 W AC

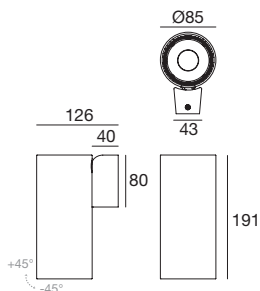

Balance - CRI 92		Cct	lm S - D	Optic
White	81999	M 2700	3220 - On req	15 Spot -
Black	82000	W 3000	3373 - On req	30 Flood -
		N 4000	3626 - On req	60 W.Flood -

Pound_Wall Focus | Projectors | 190-250 V AC | arrayLED 6,5 W DC - 8,5 W AC

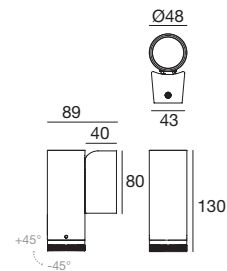

Balance - CRI 92		Cct	lm S - D	Optic
White	82055	M 2700	621 - On req	85 15° - 60°
Black	82056	W 3000	665 - On req	
		N 4000	718 - On req	

Optiques & accessoires Pag. 274/275

Pound_Wall Focus | Projectors | 190-250 V AC | arrayLED 17,5 W DC - 19,5 W AC

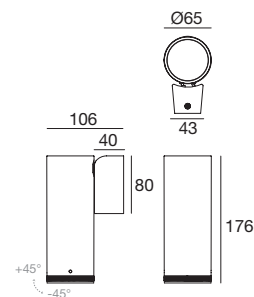

Balance - CRI 92		Cct	lm S - D	Optic
White	82057	M 2700	1939 - On req	85 15° - 60°
Black	82058	W 3000	2030 - On req	
		N 4000	2182 - On req	

Optiques & accessoires Pag. 274/275

Pound_Wall Focus | Projectors | 190-250 V AC | arrayLED 24,5 W DC - 27,5 W AC

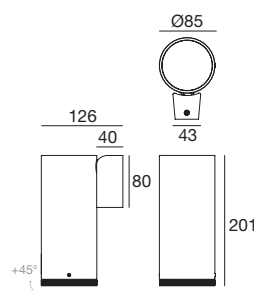

Balance - CRI 92		Cct	lm S - D	Optic
White	82059	M 2700	3033 - On req	85 15° - 60°
Black	82060	W 3000	3177 - On req	
		N 4000	3416 - On req	

Optiques

description

99805 Spot

suitable for: Pound_S 6,5W / Pound_Wall 6,5W



description

99806 Flood

suitable for: Pound_S 6,5W / Pound_Wall 6,5W



description

99807 Wide Flood

suitable for: Pound_S 6,5W / Pound_Wall 6,5W



description

99827 Spot

suitable for: Pound_S 17,5W / Pound_Wall 17,5W



description

99828 Flood

suitable for: Pound_S 17,5W / Pound_Wall 17,5W



description

99829 Wide Flood

suitable for: Pound_S 17,5W / Pound_Wall 17,5W

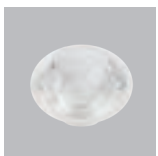

description

99808 Spot

suitable for: Pound_S 26W / Pound_Wall 26W



description

99809 Flood

suitable for: Pound_S 26W / Pound_Wall 26W



description

99810 Wide Flood

suitable for: Pound_S 26W / Pound_Wall 26W

Accessoires



description	
99775	Filtre elliptique
suitable for: Pound_S 6,5W / Pound_Wall 6,5W	

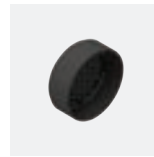

description	
99776	Honeycomb
suitable for: Pound_S 6,5W / Pound_Wall 6,5W	

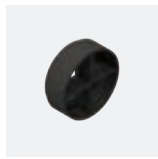

description	
99777	Défecteur en croix
suitable for: Pound_S 6,5W / Pound_Wall 6,5W	



description	
99774	Écran cylindrique
suitable for: Pound_S 6,5W / Pound_Wall 6,5W	



description	
99773	Écran cylindrique 45°
suitable for: Pound_S 6,5W / Pound_Wall 6,5W	



description	
99781	Filtre elliptique
suitable for: Pound_S 17,5W / Pound_Wall 17,5W	



description	
99780	Honeycomb
suitable for: Pound_S 17,5W / Pound_Wall 17,5W	

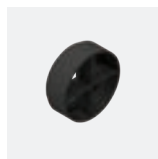

description	
99779	Défecteur en croix
suitable for: Pound_S 17,5W / Pound_Wall 17,5W	



description	
99783	Écran cylindrique
suitable for: Pound_S 17,5W / Pound_Wall 17,5W	



description	
99782	Écran cylindrique 45°
suitable for: Pound_S 17,5W / Pound_Wall 17,5W	



description	
99797	Filtre elliptique
suitable for: Pound_S 26W / Pound_Wall 26W	

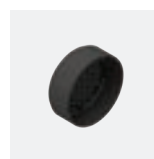

description	
99798	Honeycomb
suitable for: Pound_S 26W / Pound_Wall 26W	

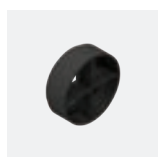

description	
99799	Défecteur en croix
suitable for: Pound_S 26W / Pound_Wall 26W	



description	
99796	Écran cylindrique
suitable for: Pound_S 26W / Pound_Wall 26W	



description	
99795	Écran cylindrique 45°
suitable for: Pound_S 26W / Pound_Wall 26W	



cell

Matériaux
Corps en aluminium

Cell_S | Ceiling lights | 190-250 V AC | 3 x powerLEDs | 5 W DC - 7 W AC

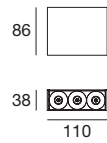

CRI 80/92

Wh	Bk	65190
Black		65191

	Cct	lm S - D CRI 80	lm S - D CRI 92	Optic
M	2700	-	561 - 382	15 Spot (12°)
W	3000	-	597 - 439	30 Flood (32°)
N	4000	639 - 568	-	45 W.Flood(49°)

Cell_S | Ceiling lights | 190-250 V AC | 6 x powerLEDs | 9 W DC - 11 W AC

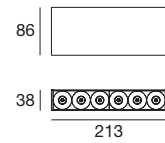

CRI 80/92

Wh	Bk	65192
Black		65193

	Cct	lm S - D CRI 80	lm S - D CRI 92	Optic
M	2700	-	1122 - 796	15 Spot (12°)
W	3000	-	1194 - 907	30 Flood (32°)
N	4000	1278 - 1181	-	45 W.Flood(49°)

Cell_SWw | Ceiling lights | 190-250 V AC | 3 x powerLEDs | 9,5 W DC - 10,5 W AC

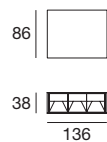

CRI 92

White	82603	M 2700	1099 - 0n req	07 Asymm. -
Black	82604	W 3000	1152 - 0n req	
		N 4000	1426 - 0n req	

Cell_SWw | Ceiling lights | 190-250 V AC | 6 x powerLEDs | 19 W DC - 21 W AC

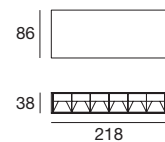

CRI 92

White	82605	M 2700	2198 - 0n req	07 Asymm. -
Black	82606	W 3000	2304 - 0n req	
		N 4000	2852 - 0n req	



baton

Matériaux
Corps en aluminium



baton lighting concept



	_P Pendant	_R Round	_Q Square
2W	-	Ø 30 - H 30 mm	30x30 mm
3W	Ø 32 - H 350 mm Ø 32 - H 500 mm	-	-
7,3W	Ø 60 - H 250 mm Ø 60 - H 400 mm	Ø 80 - H 120 mm	80x120 mm 80x200 mm
Finish	White Bk White Au Black Au	White White Bk White Au	White White Bk White Au
CRI 92	3000K - 4000K	2W 3000K - 4000K - 5000K 3000K - 4000K	2W 3000K - 4000K - 5000K 3000K - 4000K
Optics	Wide Flood - Extra Wide Flood	Narrow Spot - Flood Wide Flood - Extra Wide Flood	Narrow Spot - Flood Wide Flood - Extra Wide Flood
⊗ Control	-	2W On/Off	2W On/Off
☰ Control	On/Off	7,3W On/Off	7,3W On/Off

Émission contrôlée

Baton crée des effets de lumière à contraste élevé. La lentille intégrée au corps crée un faisceau de lumière caractérisé par des bord nets permettant de valoriser n'importe quel objet éclairé.

La position en retrait de la LED permet à cette suspension d'émettre une lumière extrêmement confortable pour l'œil, parfaite notamment pour l'éclairage de tables et de comptoirs de bar.

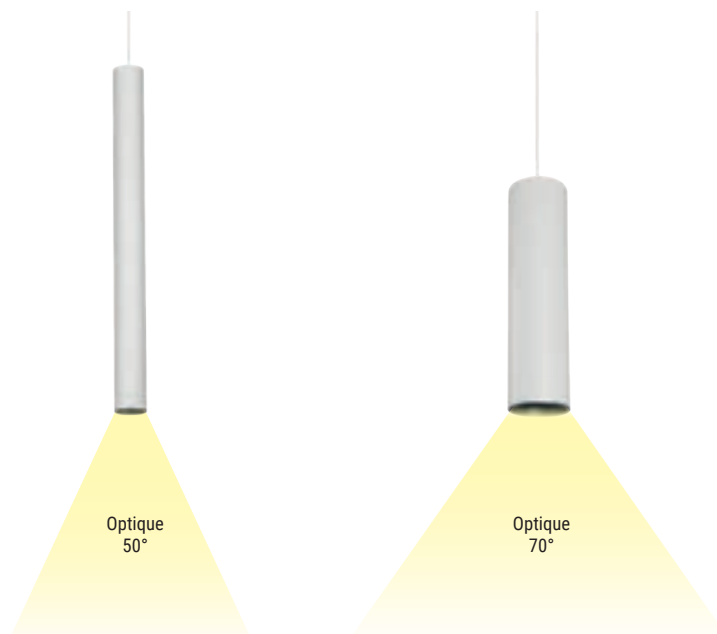

Gamme

Baton propose un design extrêmement minimaliste lorsqu'elle est utilisée individuellement. Mais ses multiples formes disponibles peuvent se combiner pour donner naissance à de fascinantes compositions scénographiques.



Finitions

Les corps en aluminium, peints avec des poudres de finition blanc matt ou noir matt, se marient parfaitement à l'espace architectural. L'intérieur du groupe optique confère au produit une légère touche de couleur et se décline en noir matt et or matt.

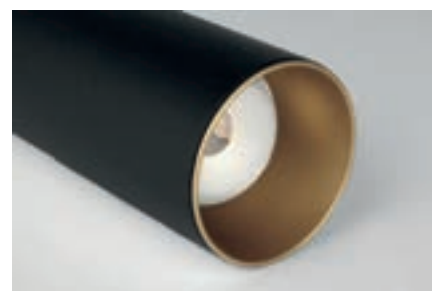
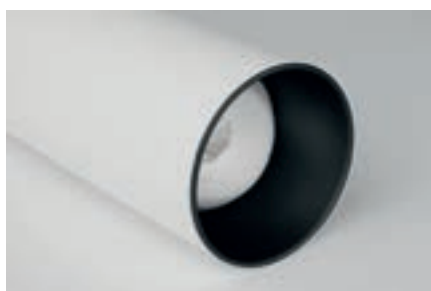

Baton_P | Pendant Luminaires | 220-240 V AC | arrayLED 3 W DC - 5 W AC

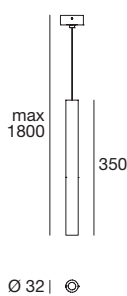

CRI 80	Cct	lm S - D	Optic
White Bk 64785	W 3000	325 - 250	50 Flood (55°)
White Au 64786	N 4000	351 - 250	
Black Au 64787			

RTG 64787W50

Baton_P | Pendant Luminaires | 220-240 V AC | arrayLED 3 W DC - 5 W AC

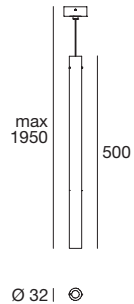

CRI 80	Cct	lm S - D	Optic
White Bk 64782	W 3000	325 - 250	50 Flood (55°)
White Au 64783	N 4000	351 - 250	
Black Au 64784			

Baton_P | Pendant Luminaires | 220-240 V AC | arrayLED 7,3 W DC - 9 W AC

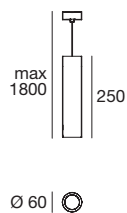

CRI 80	Cct	lm S - D	Optic
White Bk 64742	W 3000	988 - 690	70 Flood (70°)
White Au 64741	N 4000	1058 - 720	
Black Au 64754			

RTG 64742W70

Baton_P | Pendant Luminaires | 220-240 V AC | arrayLED 7,3 W DC - 9 W AC

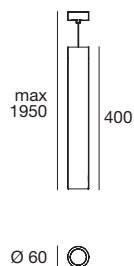

CRI 80	Cct	lm S - D	Optic
White Bk 64744	W 3000	988 - 690	70 Flood (70°)
White Au 64743	N 4000	1058 - 720	
Black Au 64755			

Baton_R | Ceiling luminaires | powerLED 2 W DC 630 mA

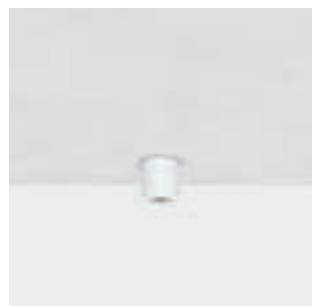

30 | □

○
Ø30

CRI 80	Cct	lm S - D	Optic
White 91328	W 3000	233 - 183	10 N.Spot (33°)
	N 4000	249 - 195	30 Flood (44°)
	C 5000	266 - 223	50 W.Flood (69°)
			70 E.W.Flood(77°)
			12 E.W.Flood(113°)

Électronique

89147	99376	99105	99710	99713	+ driver 24V DC 99374 75W 99331 150W
ON/OFF 1 - 2 art. p 138 x l 22 x h 21	ON/OFF 3 - 6 art. p 138 x l 22 x h 21	ON/OFF 6 - 12 art. p 103 x l 58 x h 27	24V DC converter 0/1-10V 1 art. p 138 x l 22 x h 21	24V DC converter DALI 1 art. p 138 x l 22 x h 21	

Baton_Q | Ceiling luminaires | powerLED 2 W DC 630 mA

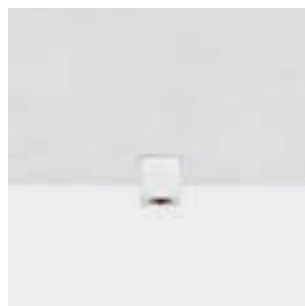

30 | □

□
□30

CRI 80	Cct	lm S - D	Optic
White 91330	W 3000	233 - 183	10 N.Spot (33°)
	N 4000	249 - 195	30 Flood (44°)
	C 5000	266 - 223	50 W.Flood (69°)
			70 E.W.Flood(77°)
			12 E.W.Flood(113°)

Électronique

89147	99376	99105	99710	99713	+ driver 24V DC 99374 75W 99331 150W
ON/OFF 1 - 2 art. p 138 x l 22 x h 21	ON/OFF 3 - 6 art. p 138 x l 22 x h 21	ON/OFF 6 - 12 art. p 103 x l 58 x h 27	24V DC converter 0/1-10V 1 art. p 138 x l 22 x h 21	24V DC converter DALI 1 art. p 138 x l 22 x h 21	

Baton_R | Ceiling Lights | 220-240 V AC | 7,3 W DC - 9 W AC



Ø 80 | ○

120 | □

CRI 80	Cct	lm S - D	Optic
White 64747	W 3000	988 - 745	60 Flood (72°)
White Bk 64749	N 4000	1058 - 780	
White Au 64738			

Baton_Q | Ceiling Lights | 220-240 V AC | 7,3 W DC - 9 W AC



□80 | ○

L | □

CRI 80 - 120mm	Cct	lm S - D	Optic
White 64756	W 3000	988 - 745	60 Flood (72°)
White Bk 64745	N 4000	1058 - 780	
White Au 64739			



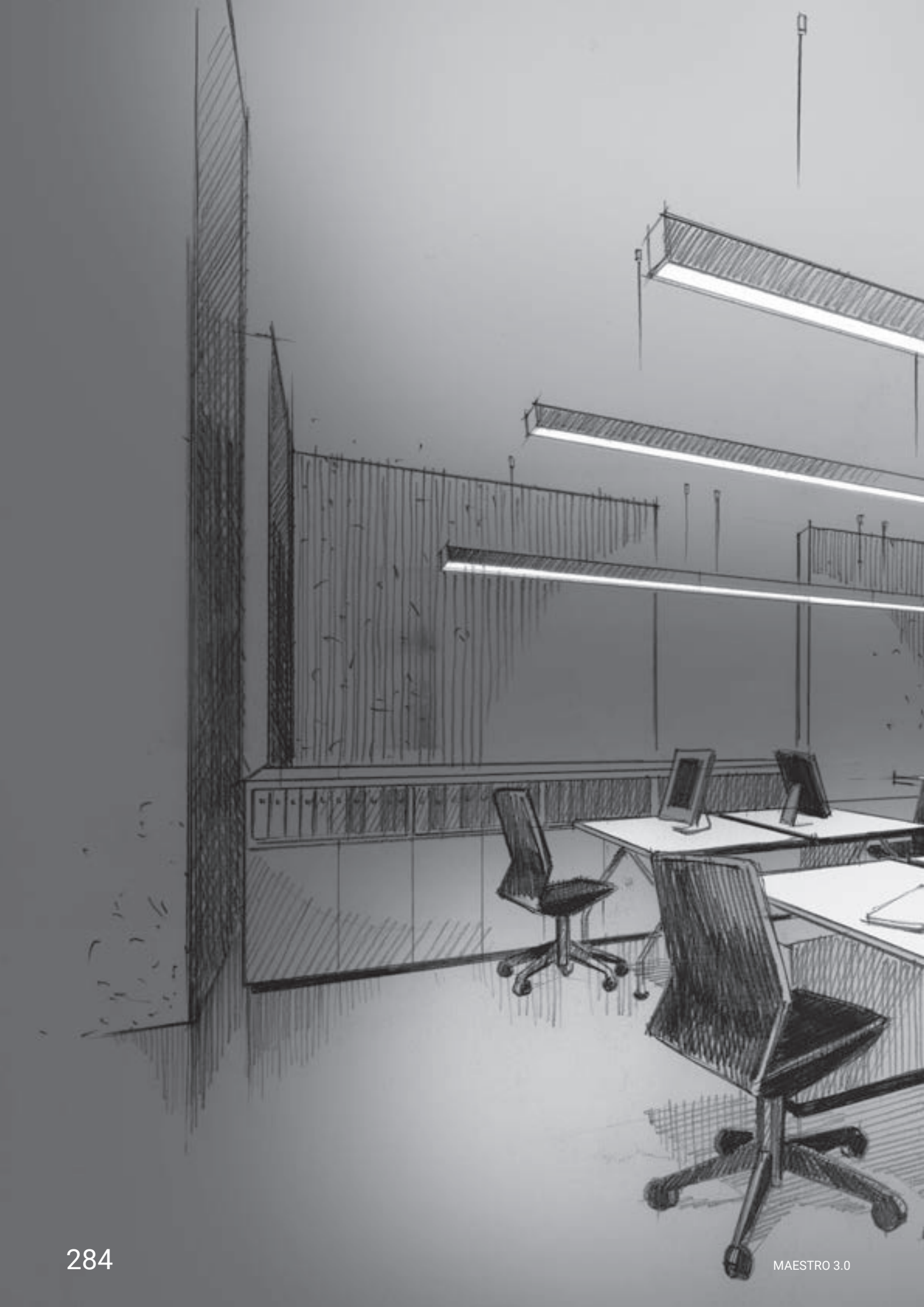

















CRI 80 - 200mm	Cct	lm S - D	Optic
White 64757	W 3000	988 - 745	60 Flood (72°)
White Bk 64746	N 4000	1058 - 780	
White Au 64740			

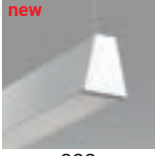

Linear System

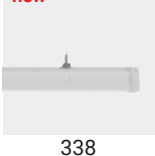

linear system range index

Modus	Modus_M  new 294	Modus_M Complete  new 298					
Rollip	Rollip PRO  new 304	RollipPRO_C  305	Rollip35_MC  308	Rollip70_MC  310	Rollip35_C  312	Rollip70_C  312	Rollip35_MS  new 314
	Rollip60_MS  new 315	Rollip35_MP  new 316	Rollip7035_MP  new 318	Rollip60_MP  new 320	Rollip35_PC  new 322	Rollip7035_PC  new 322	Rollip60_PC  new 323
Clear	Clear_MP  new 327						
Mini_Albatros	Mini Albatros  new 334	Mini Albatros_M  new 334					
Trail	Trail  new 338						
Ink	Ink  new 346						

Fylo+

Fylo+ Direct



365

Fylo+ Recessed



366

Fylo+ Surface



368

Archicove

Archicove



374

Ice-Cut

Ice-Cut



378

Ice-Cut_F



379



modus

Matériaux

Profilé en aluminium

Diffuseur en polycarbonate

Accessoires en aluminium



modus

design Arch. Jacopo Acciaro

Système étendu et versatile

Modus est un système à suspension modulable et modulaire adaptable. Modus est un rail en aluminium électrifié, disponible en trois finitions, blanc neutre, noir, bruni et dans une vaste gamme de modules procurant une grande liberté de composition. Le système comprend différents éléments et de nombreux accessoires, chacun d'eux étant consacré à un scénario d'éclairage spécifique ou à un environnement opérationnel précis. À la grande facilité d'utilisation vient s'ajouter la rapidité d'intégration et la possibilité de varier les éléments, tous insérables facilement d'une simple pression dans le rail. Modus, extrêmement polyvalent s'adapte à différents univers, tels que les bureaux, les commerces, les musées ou encore les résidences modernes. Modus est un système pensé et conçu pour simplifier et accélérer toute étude photométrique, même la plus complexe.

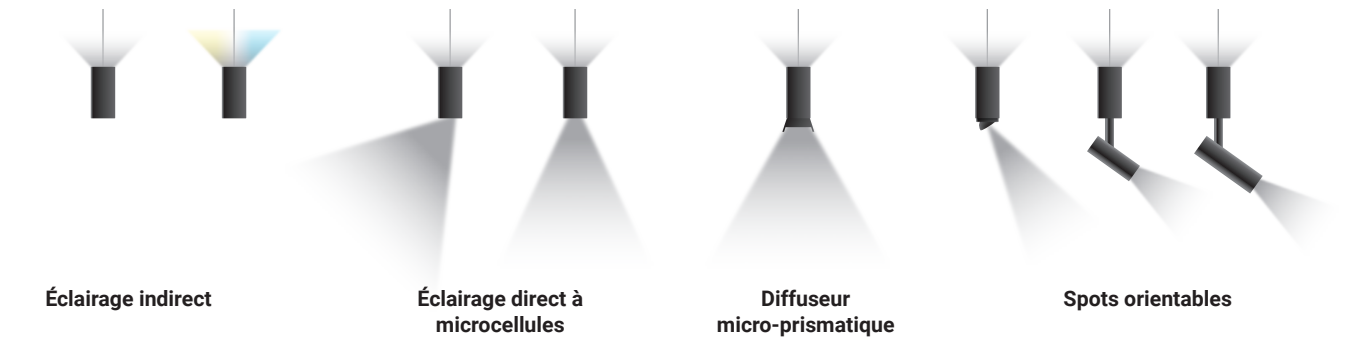

Module asymétrique

Le système est équipé d'un diffuseur asymétrique à microcellules. Équipé de LED de hautes performances, le module garantit une ample uniformité des murs illuminés, en augmentant la perception des espaces éclairés par le système.



Module spots orientables

Équipé de spots orientables, le système définit non seulement des environnements de bureau, mais aussi des zones multitâches qui nécessitent un éclairage fonctionnel. Outre les 2 projecteurs de 11 et 6 watts, le système inclut également des micro-projecteurs Optus_EX qui disparaissent à l'intérieur du profilé extrudé en raison de leurs dimensions extrêmement réduites.



Confort et bien-être visuel

Modus est un système optimisé pour l'éclairage centré sur l'humain, conçu pour améliorer le temps passé sur le lieu de travail et d'étude, fondé sur les principes du rythme circadien. Le produit a été conçu et réalisé pour offrir un confort visuel et de vie très élevé aux occupants, en augmentant le bien-être et la productivité. Dans la partie supérieure du profilé, un système optique spécial a fait l'objet d'une étude qui permet une ouverture de 150° du faisceau lumineux. Outre les deux températures de couleur monochromatiques (3500°K ou 4000 K°), la technologie Dynamic White (de 2700°K à 5000°K) permet un éclairage ambiant indirect favorisant les longs séjours dans les espaces de travail. C'est un système flexible et totalement adaptable.



DW

2700 K

5000 K

Ample gamme d'accessoires

Modus est un système linéaire composé de plusieurs éléments lumineux, spots et projecteurs orientables, modules avec cellules anti-éblouissement UGR<19, éclairage rasant (un seul module permet de diriger le faisceau asymétrique vers la droite ou la gauche) et des modules linéaires avec UGR<19. Disponibles également en module individuel dans deux longueurs (1200 et 2400 mm). La vaste gamme et l'enclenchement rapide du système facilitent les interventions de remplacement des appareils ou le changement des mises en scène. D'un simple geste, il est possible de changer les accessoires et la mise en scène. Le système inclut également le protocole DALI le plus récent.



Module à microcellules

Le système pour éclairage direct à microcellules avec optiques arrière (Darklight) est conçu pour distribuer le faisceau lumineux de manière nette et uniforme sur la surface éclairée, afin d'assurer un confort important (UGR<19) sans impacter les espaces de travail voisins.



Éclairage indirect

La composante indirecte de Modus est équipée d'un circuit haute performance avec un angle d'ouverture de 150° grâce à l'utilisation de micro-optiques réparties dans la partie supérieure du châssis. Disponible en lumière blanche ou technologie Dynamic white, Modus distribue la lumière de manière uniforme sur toute la superficie du plafond en augmentant le confort visuel dans toute la pièce.



Module linéaire micro-prismatique

Le module est disponible en 3 dimensions différentes pour répondre à diverses demandes selon le projet. Il est doté d'un circuit à LED très performant et garantit une distribution de la lumière uniforme avec de faibles niveaux d'éblouissement (UGR<19), grâce à un système optique composé de la superposition de microcellules, d'un filtre Batwing, et d'un réfracteur micro-prismatique.



Modus_M Micropismatic



Principali parametri illuminotecnici

UGR	<19	-
Em Task light	>500lx	U0>0,6
Em Area circ	>300lx	U0>0,4
E. sfondo	>100lx	U0>0,1
E. pareti	>75lx	U0>0,1
E. soffitto	>50lx	U0>0,1
E. cil. (120cm)	>150lx	U0>0,1
E. cil. (160cm)	>75lx	U0>0,1

Vérification effectuée dans un bureau type de 10 x 10 m (100 m²) dans une fourchette de 270 à 350 cm de haut. Les valeurs indiquées correspondent à une dimension intermédiaire de 300 cm de haut. Appareil installé à 230 cm. Coefficients de réflexion aux normes (0,7 plafond, 0,5 mur et 0,2 sol). Bureau de 160 x 360 cm avec 6 postes de travail.

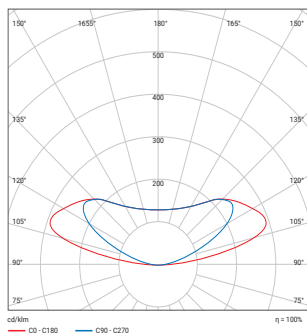

Modus_M Indirect

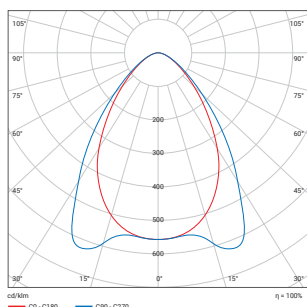

Modus_M Microprismatic Direct

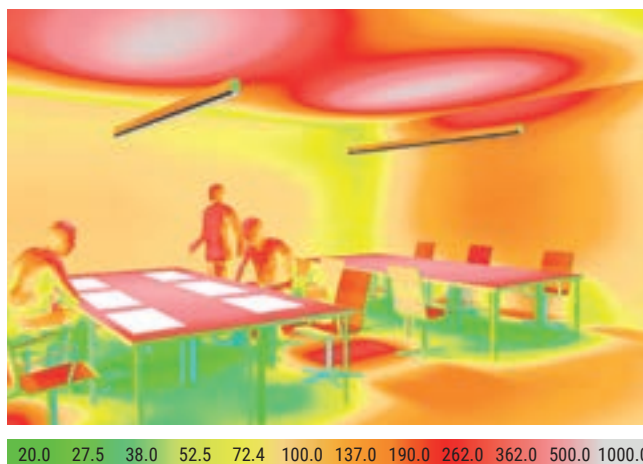

20.0 27.5 38.0 52.5 72.4 100.0 137.0 190.0 262.0 362.0 500.0 1000.0

Modus_M Cell



Principali parametri illuminotecnici

UGR	<19	-
Em Task light	>500lx	U0>0,6
Em Area circ	>300lx	U0>0,4
E. sfondo	>100lx	U0>0,1
E. pareti	>75lx	U0>0,1
E. soffitto	>50lx	U0>0,1
E. cil. (120cm)	>50lx	U0>0,1
E. cil. (160cm)	>50lx	U0>0,1

Vérification effectuée dans un bureau type de 10 x 10 m (100 m²) dans une fourchette de 270 à 350 cm de haut. Les valeurs indiquées correspondent à une dimension intermédiaire de 300 cm de haut. Appareil installé à 230 cm. Coefficients de réflexion aux normes (0,7 plafond, 0,5 mur et 0,2 sol). Bureau de 160 x 360 cm avec 6 postes de travail.

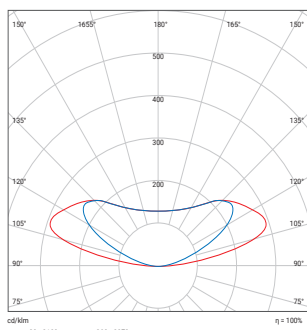

Modus_M Indirect

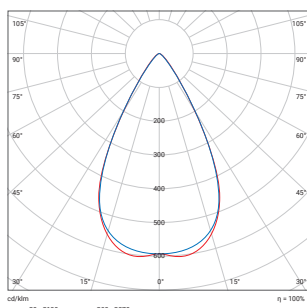

Modus_M Cell Direct

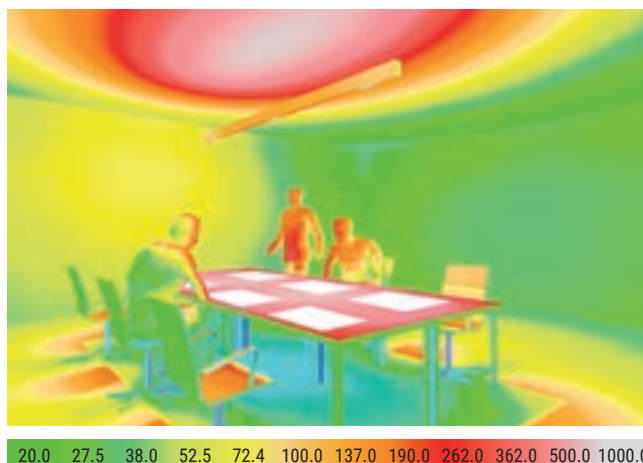

20.0 27.5 38.0 52.5 72.4 100.0 137.0 190.0 262.0 362.0 500.0 1000.0

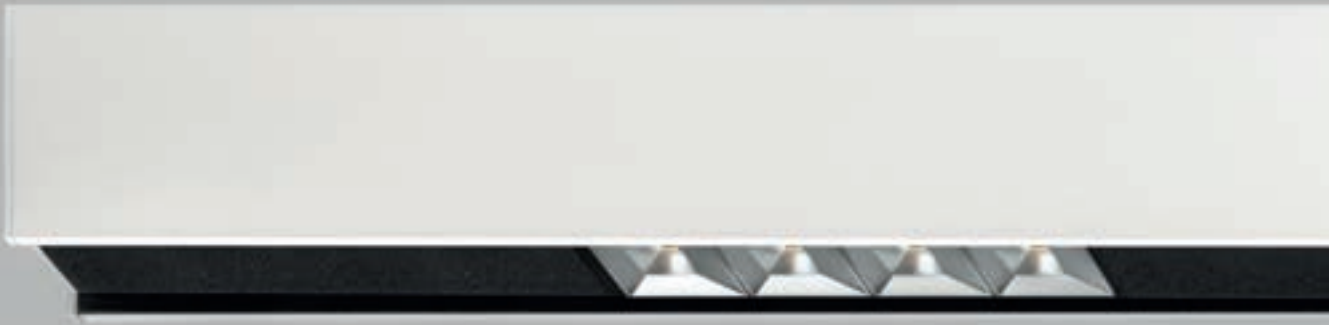

White - Black

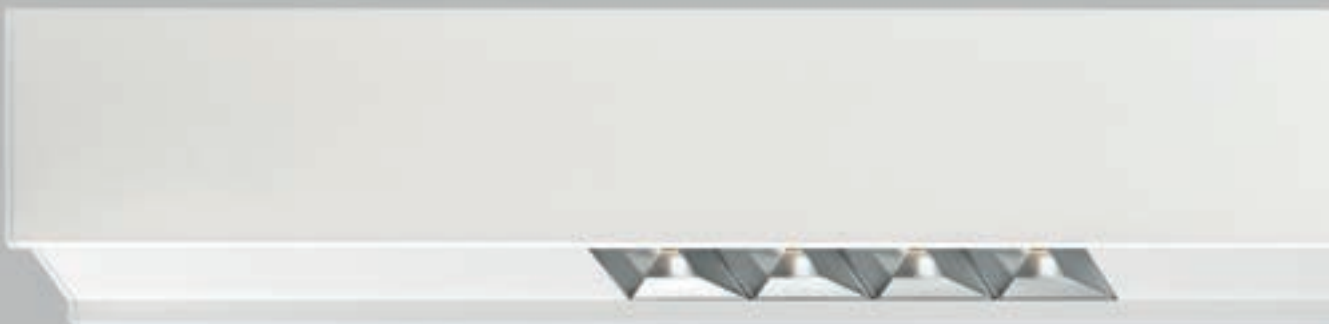

White - White



Black - Black

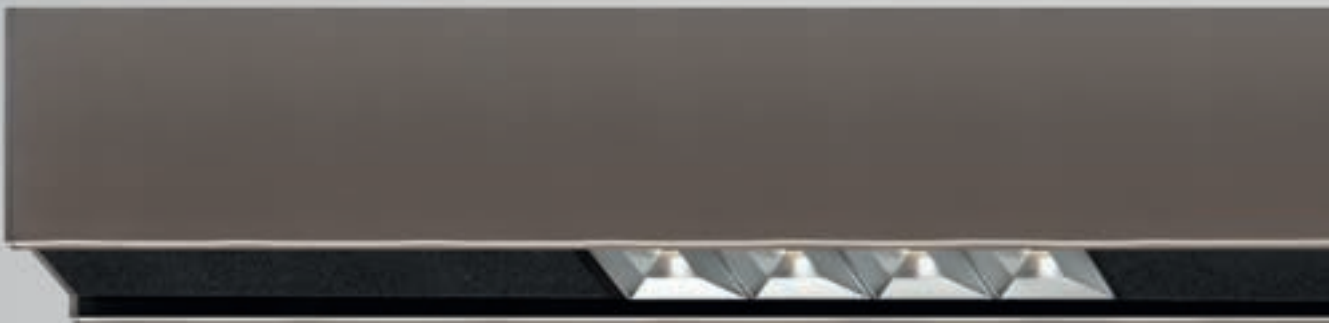

Burnished - Black

Modus_M Master | Lines | 190-250 V AC | topLED

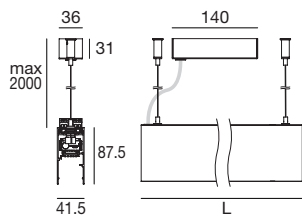

1200 mm - 22W DC - 24W AC		Cct	lm S - D	Optic
White	83712	W 3500	3020 - On Req	00 General -
Black	83736	N 4000	3175 - On Req	
Burnished	83782			

1500 mm - 29W DC - 31W AC		Cct	lm S - D	Optic
White	83713	W 3500	4027 - On Req	00 General -
Black	83737	N 4000	4234 - On Req	
Burnished	83783			

2400 mm - 47W DC - 51W AC		Cct	lm S - D	Optic
White	83714	W 3500	6544 - On Req	00 General -
Black	83738	N 4000	6880 - On Req	
Burnished	83784			

3000 mm - 62W DC - 67W AC		Cct	lm S - D	Optic
White	83715	W 3500	8558 - On Req	00 General -
Black	83739	N 4000	8996 - On Req	
Burnished	83785			

Available from April 2021

Modus_M Corner | Lines

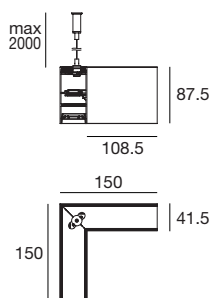

150x150 mm	
White	83733
Black	83757
Burnished	83790

Available from April 2021

Modus_M Slave | Lines | 190-250 V AC | topLED

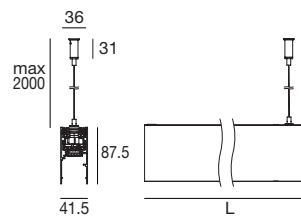

1200 mm - 22W DC - 24W AC		Cct	lm S - D	Optic
White	83716	W 3500	3020 - On Req	00 General -
Black	83740	N 4000	3175 - On Req	
Burnished	83786			

1500 mm - 29W DC - 31W AC		Cct	lm S - D	Optic
White	83717	W 3500	4027 - On Req	00 General -
Black	83741	N 4000	4234 - On Req	
Burnished	83787			

2400 mm - 47W DC - 51W AC		Cct	lm S - D	Optic
White	83718	W 3500	6544 - On Req	00 General -
Black	83742	N 4000	6880 - On Req	
Burnished	83788			

3000 mm - 62W DC - 67W AC		Cct	lm S - D	Optic
White	83719	W 3500	8558 - On Req	00 General -
Black	83743	N 4000	8996 - On Req	
Burnished	83789			

Available from April 2021

Modus_M | Cap kits

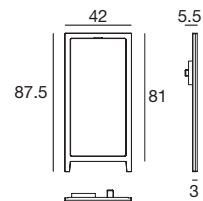
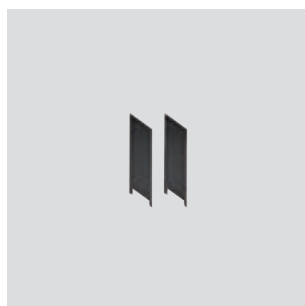

2 x	
83108	White
83109	Black
83110	Burnished

Available from April 2021

Modus_M Master Dynamic-White | Lines | 190-250 V AC | topLED

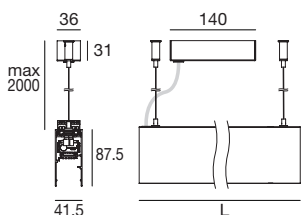

1200 mm - 20W DC - 23W AC	Cct	lm S - D	Optic
White 83791	D Dynamic	On Req	00 General -
Black 83815			
Burnished 83842			

1500 mm - 27W DC - 30W AC	Cct	lm S - D	Optic
White 83792	D Dynamic	On Req	00 General -
Black 83816			
Burnished 83843			

2400 mm - 43W DC - 48W AC	Cct	lm S - D	Optic
White 83793	D Dynamic	On Req	00 General -
Black 83817			
Burnished 83844			

3000 mm - 55W DC - 60W AC	Cct	lm S - D	Optic
White 83794	D Dynamic	On Req	00 General -
Black 83818			
Burnished 83845			

Available from April 2021

Modus_M Corner | Lines

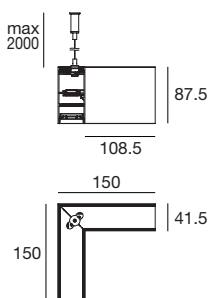

150x150 mm	Cct	lm S - D	Optic
White 83733			
Black 83757			
Burnished 83790			

Available from April 2021

Modus_M Slave Dynamic-White | Lines | 190-250 V AC | topLED

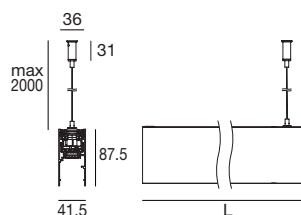

1200 mm - 20W DC - 23W AC	Cct	lm S - D	Optic
White 83795	D Dynamic	On Req	00 General -
Black 83819			
Burnished 83846			

1500 mm - 27W DC - 30W AC	Cct	lm S - D	Optic
White 83796	D Dynamic	On Req	00 General -
Black 83820			
Burnished 83847			

2400 mm - 43W DC - 48W AC	Cct	lm S - D	Optic
White 83797	D Dynamic	On Req	00 General -
Black 83821			
Burnished 83848			

3000 mm - 55W DC - 60W AC	Cct	lm S - D	Optic
White 83798	D Dynamic	On Req	00 General -
Black 83822			
Burnished 83849			

Available from April 2021

Modus_M | Cap kits

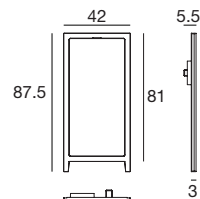
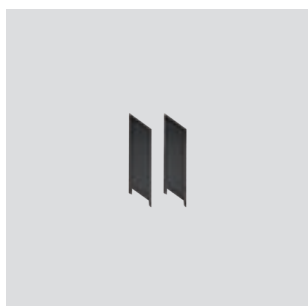

2 x	Cct	lm S - D	Optic
83108	White		
83109	Black		
83110	Burnished		

Available from April 2021

Modus_M Microprismatic | Lines | 24 V DC | topLED

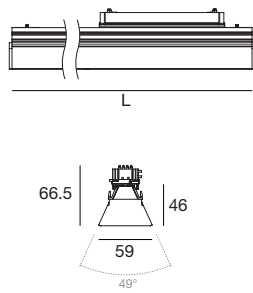

900 mm - 19W DC - CRI 92		Cct	lm S - D	Optic
White	83722	W 3500	2362 - On Req	96 Batwing -
Black	83746	N 4000	2484 - On Req	
Allum.	83760			

1200 mm - 24W DC - CRI 92		Cct	lm S - D	Optic
White	83723	W 3500	3150 - On Req	96 Batwing -
Black	83747	N 4000	3311 - On Req	
Allum.	83761			

1500 mm - 30W DC - CRI 92		Cct	lm S - D	Optic
White	83724	W 3500	3937 - On Req	96 Batwing -
Black	83748	N 4000	4139 - On Req	
Allum.	83762			

Available from April 2021

Modus_M Projectors | Lines | 24 V DC | powerLEDs 7W DC

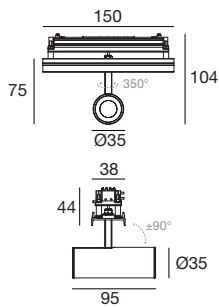

CRI 92		Cct	lm S - D	Optic
White	83731	W 3500	569 - On req	10 Spot
Black	83755	N 4000	614 - On req	30 Flood
				45 Flood

Available from April 2021

Modus_M Optus_EX | Lines | 24 V DC | powerLEDs | 5W DC

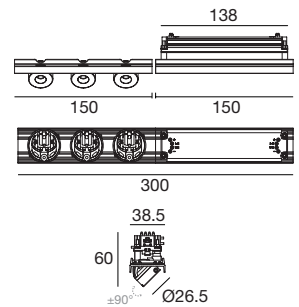

Efficiency - CRI 92		Cct	lm S - D	Optic
White	83732	W 3500	522 - On req	20 Spot -
Black	83756	N 4000	561 - On req	35 Flood -

Available from April 2021

Modus_M Projectors | Lines | 24 V DC | arrayLED 12W DC

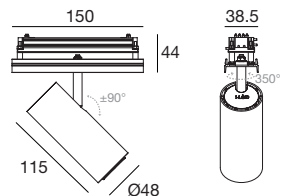

CRI 92		Cct	lm S - D	Optic
White	83730	W 3500	1284 - On req	15 Spot
Black	83754	N 4000	1320 - On req	30 Flood
				60 Flood

Available from April 2021

Modus_M Cell_WW | Lines | 24 V DC | powerLEDs 12W DC

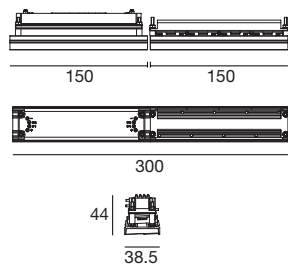

CRI 92	Cct	lm S - D	Optic
White 83721	W 3500	1281 - On req	07 Asymm.
Black 83745	N 4000	1383 - On req	

Available from April 2021

Modus_M Cell | Lines | 24 V DC | powerLEDs 12W DC

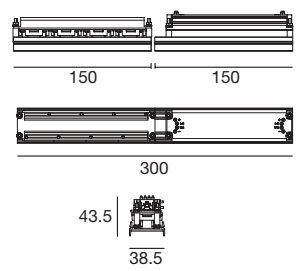

CRI 92	Cct	lm S - D	Optic
White 83720	W 3500	1281 - On req	60 E.W.Flood
Black 83744	N 4000	1383 - On req	

Available from April 2021

Modus_M | Remplissage inférieur

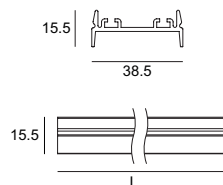

150 mm

White 83725
Black 83749

300 mm

White 83729
Black 83753

600 mm

White 83726
Black 83750

900 mm

White 83727
Black 83751

1200 mm

White 83728
Black 83752

Available from April 2021

Linear System

Modus_M Complete | Lines | 190-250 V AC | topLED

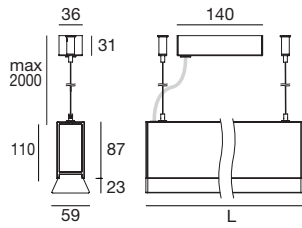

1206 mm 46W DC - 48W AC - CRI92	Cct	lm S - D	Optic
Black AL. 84255	W 3500	6325 - On Req	96 Batwing. -
White 83734	N 4000	6331 - On Req	
Black 83758			

2406 mm 95W DC - 100W AC - CRI92	Cct	lm S - D	Optic
Black AL. 84256	W 3500	13180 - On Req	96 Batwing -
White 83735	N 4000	13166 - On Req	
Black 83759			

Available from April 2021

Modus_M Complete | Lines | 190-250 V AC | topLED

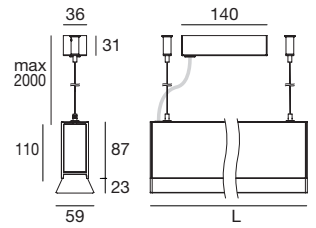

1206 mm 46W DC - 48W AC - CRI92	Cct	lm S - D	Optic
Black AL. 84257	W 3500	6325 - On Req	96 Batwing -
White 83813	N 4000	6331 - On Req	
Black 83837			

2406 mm 95W DC - 100W AC - CRI92	Cct	lm S - D	Optic
Black AL. 84258	W 3500	13180 - On Req	96 Batwing -
White 83814	N 4000	13166 - On Req	
Black 83838			

Available from April 2021







rollip

Matériaux

Profilé en aluminium

Diffuseur en polycarbonate



rollip range



	PRO Recessed	35_MC Recessed	70_MC Recessed	35_MS Surface	60_MS Surface	35_MP Pendant	7035_MP Pendant	60_MP Pendant
12W	595 mm	-	-	-	-	-	-	-
20W	-	1002 mm 532x532 mm	1002 mm	1005 mm 530x530 mm	1005 mm 530x530 mm	1005 mm 530x530 mm	1005 mm	1005 mm
21,5W	512x512 mm	-	-	-	-	-	-	-
22W	-	-	1200 mm Stand-alone	-	-	-	-	-
24W	1185 mm Modular Stand-alone	-	-	-	-	-	-	-
27W	-	-	-	1505 mm	1505 mm	1505 mm	1505 mm	1505 mm
30W	1505 mm Modular Stand-alone	1503 mm Modular Stand-alone	1503 mm Modular Stand-alone	-	1505 mm	-	-	-
40W	-	2004 mm	1002 mm 2004 mm	2005 mm	2005 mm	1005 mm 2005 mm 530x530 mm	1005 mm 2005 mm	1005 mm 2005 mm
48W	-	-	1200 mm Stand-alone	-	-	-	-	-
54W	-	-	-	-	-	1505 mm	1505 mm	1505 mm
60W	-	3006 mm	1503 mm Stand-alone 3006 mm Modular	-	-	-	-	-
80W	-	-	2004 mm	-	-	2005 mm	2005 mm	2005 mm
120W	-	-	3006 mm	-	-	-	-	-
Finish	<input type="checkbox"/> White	<input type="checkbox"/> White	<input type="checkbox"/> White	<input type="checkbox"/> White <input type="checkbox"/> Black	<input type="checkbox"/> White <input type="checkbox"/> Black	<input type="checkbox"/> White	<input type="checkbox"/> White	<input type="checkbox"/> White <input type="checkbox"/> Black
CRI 80	3000K - 4000K	3000K - 4000K	3000K - 4000K	3000K - 4000K	3000K - 4000K	3000K - 4000K	3000K - 4000K	3000K - 4000K
CRI 92	3000K - 4000K	3000K - 4000K	3000K - 4000K	3000K - 4000K	3000K - 4000K	3000K - 4000K	3000K - 4000K	3000K - 4000K
Optics	General Anti-glaring	General Asymmetric	General Asymmetric Anti-glaring	General	General Anti-glaring	General	General Anti-glaring	General
Control	On/Off - DALI 1/10V	On/Off - DALI 1/10V	On/Off - DALI 1/10V	DALI	DALI	On/Off - DALI	On/Off - DALI	On/Off - DALI

Large gamme de produits

Versions à encastrement de 35 et 70 mm déclinées en luminaires autonomes finis et complets, disponibles en deux tailles différentes, ou sous forme de modules à composer pour créer des installations personnalisées. Disponibles également dans les modèles à suspension de 35 mm avec drivers embarqués, à simple et double émission, autonomes ou modulaires avec jonctions d'angle. Large et diversifiée, la gamme Rollip est conçue pour répondre aux nombreux besoins des professionnels de l'éclairage.

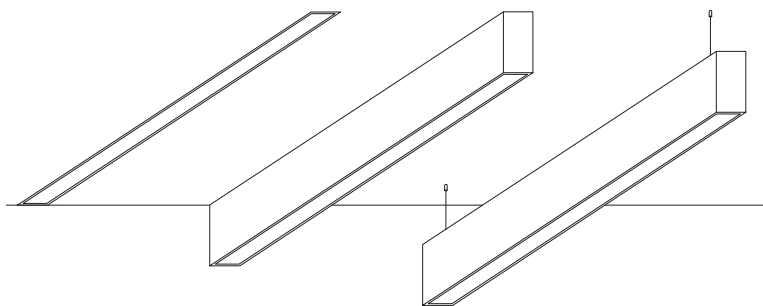

Ligne continue sans interruption

La facilité d'installation du DIFFUSEUR À ROULEAU permet de réaliser des lignes continues sans interruption, mesurant jusqu'à 50 m de longueur, en une seule et simple opération de montage avec des temps considérablement réduits. Grâce aux ailettes d'assemblage, ce diffuseur garantit un indice de protection IP54. Rollip est disponible dans les largeurs 35 mm et 70 mm, combinables avec une optique diffuse asymétrique et avec un diffuseur d'indice UGR inférieur à 19 pour une utilisation dans les bureaux et les lieux de travail (version Rollip70 uniquement).



Rollip PRO

La version PRO représente l'évolution technique maximale de la famille Rollip, grâce à l'adoption de la technologie OptiLight™ caractérisée par les microgravures laser servant à redistribuer la lumière sortant du diffuseur PMMA, et par un contrôle total de l'indice UGR pour une application dans des environnements de travail avec terminaux vidéo. L'encombrement minimal (12 mm seulement) permet d'encaster le produit dans le faux plafond sans traverser entièrement la plaque de plâtre – Rollip PRO est en effet plus fin que cette dernière – ce qui représente un avantage notable en présence de montants ou d'obstacles à l'intérieur du faux plafond.



Rollip_60

Rollip60 est innovant : une lumière indirecte avec un angle de 150° nette et performante est émise par le diffuseur supérieur préinstallé, et dans la partie inférieure disponible le diffuseur en rouleau opalin (4 dimensions, de 5 à 50 m) ou avec filtre UGR<19 (sections de 5 ou de 10 m) rend la version bi-émission idéale pour l'éclairage complet des lieux de travail qui exigent le respect du taux d'éblouissement.



RollipPRO | Lines | 24 V DC | topLED



595 mm - 12W DC - CRI 80		Cct	lm S - D
White	62470	W 3000	1806 - On Req
		N 4000	1841 - On Req

595 mm - 12W DC - CRI 92		Cct	lm S - D
White	65438	W 3000	1470 - On Req
		N 4000	1573 - On Req

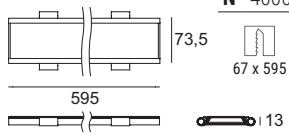

1185 mm - 24W DC - CRI 80		Cct	lm S - D
White	62471	W 3000	3612 - On Req
		N 4000	3682 - On Req

1185 mm - 24W DC - CRI 92		Cct	lm S - D
White	65439	W 3000	2940 - On Req
		N 4000	3146 - On Req

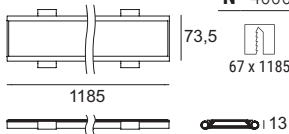

1505 mm - 30W DC - CRI 80		Cct	lm S - D
White	62472	W 3000	4577 - On Req
		N 4000	4673 - On Req

1505 mm - 30W DC - CRI 92		Cct	lm S - D
White	65440	W 3000	3733 - On Req
		N 4000	4000 - On Req

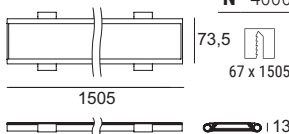

512 x 512 mm - 20 W DC - CRI 80		Cct	lm S - D
White	82257	W 3000	2772 - On Req
		N 4000	2832 - On Req

512 x 512 mm - 20 W DC - CRI 92		Cct	lm S - D
White	65441	W 3000	2268 - On Req
		N 4000	2424 - On Req

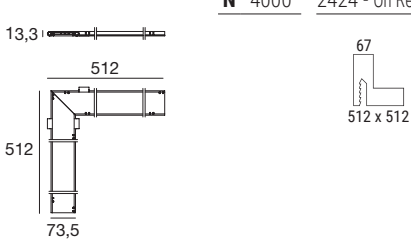

Électronique

99374	99331	99332	83062	99787
ON/OFF 75 W p 210 x 148 x h 25	ON/OFF 150 W p 150 x 160 x h 35	0/1-10V 150 W p 150 x 160 x h 35	DALI 120 W p 191 x 163 x h 38	DALI 120 W p 244 x 171 x h 38

RollipPRO | Diffuseur en rouleau

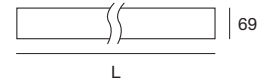

Diffuseur opalin

Opaline	62461	5 m
Opaline	62462	10 m
Opaline	62463	20 m

Diffuseur anti-éblouissement UGR<19

Opaline	62464	5 m
Opaline	62465	10 m

RollipPRO | Kit de bouchons

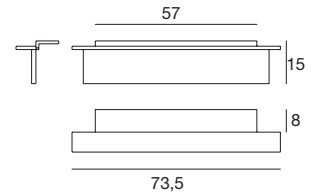
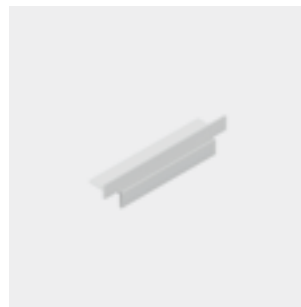

2 x	
White	62460

RollipPRO_C | Lines | 24 V DC | topLED



1199 mm - 24W DC - CRI 80		Cct	lm S - D	Optic
White	62473	W 3000	3612 - On req	00 General (106°)
		N 4000	3682 - On req	

1199 mm - 24W DC - CRI 92		Cct	lm S - D	Optic
White	65442	W 3000	2940 - On req	00 General (106°)
		N 4000	3146 - On req	

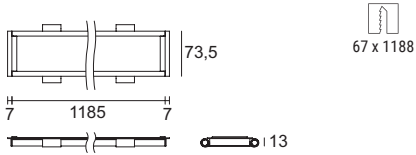

1519 mm - 30W DC - CRI 80		Cct	lm S - D	Optic
White	62474	W 3000	4577 - On req	00 General (106°)
		N 4000	4673 - On req	

1519 mm - 30W DC - CRI 92		Cct	lm S - D	Optic
White	65443	W 3000	3733 - On req	00 General (106°)
		N 4000	4000 - On req	

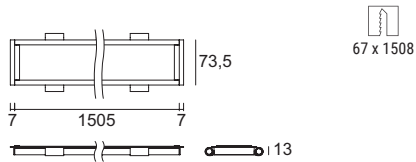

Électronique

99374	99331	99332	83062	99787
ON/OFF 75 W p 210 x l 48 x h 25	ON/OFF 150 W p 150 x l 60 x h 35	0/1-10V 150 W p 150 x l 60 x h 35	DALI 120 W p 191 x l 63 x h 38	DALI 120 W p 244 x l 71 x h 38







1002 mm - 18W DC - CRI 80		Cct	Im S - D
White	65204	W 3000	2544 - On Req
		N 4000	2620 - On Req

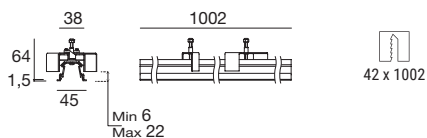

1503 mm - 27W DC - CRI 80		Cct	Im S - D
White	65205	W 3000	3816 - On Req
		N 4000	3942 - On Req

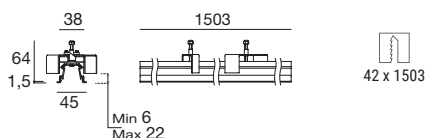

2004 mm - 35W DC - CRI 80		Cct	Im S - D
White	65206	W 3000	5088 - On Req
		N 4000	5256 - On Req

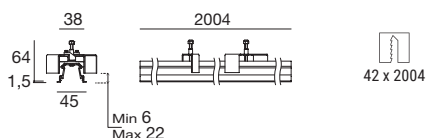

3006 mm - 50W DC - CRI 80		Cct	Im S - D
White	65207	W 3000	7632 - On Req
		N 4000	7884 - On Req

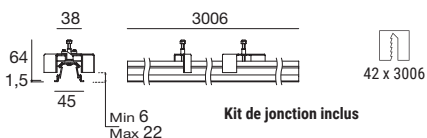

532 x 532 mm - 19W DC - CRI 80		Cct	Im S - D
White	65233	W 3000	2544 - On Req
		N 4000	2628 - On Req

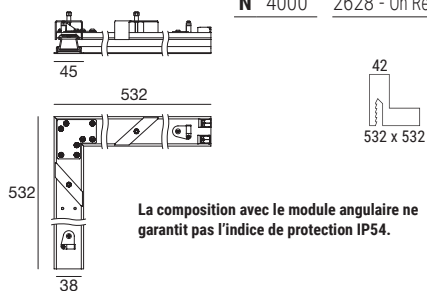

Électronique

99374	99331	99332	83062	99787
ON/OFF	ON/OFF	0/1-10V	DALI	DALI
75 W	150 W	150 W	120 W	120 W
p 210 x l 148 x h 25	p 150 x l 60 x h 35	p 150 x l 60 x h 35	p 191 x l 63 x h 38	p 244 x l 71 x h 38



1002 mm - 18W DC - CRI 92		Cct	Im S - D
White	65444	W 3000	2064 - On Req
		N 4000	2244 - On Req

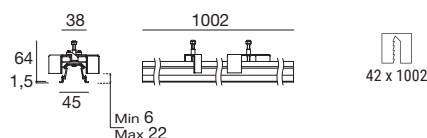

1503 mm - 27W DC - CRI 92		Cct	Im S - D
White	65445	W 3000	3096 - On Req
		N 4000	3366 - On Req

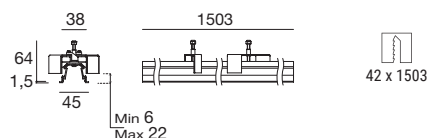

2004 mm - 35W DC - CRI 92		Cct	Im S - D
White	65446	W 3000	4128vOn Req
		N 4000	4488 - On Req

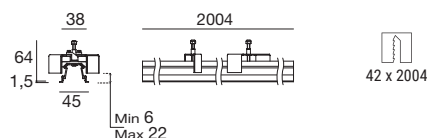

3006 mm - 50W DC - CRI 92		Cct	Im S - D
White	65447	W 3000	6192 - On Req
		N 4000	6732 - On Req

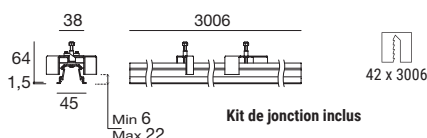

532 x 532 mm - 19W DC - CRI 92		Cct	Im S - D
White	65448	W 3000	2064 - On Req
		N 4000	2244 - On Req

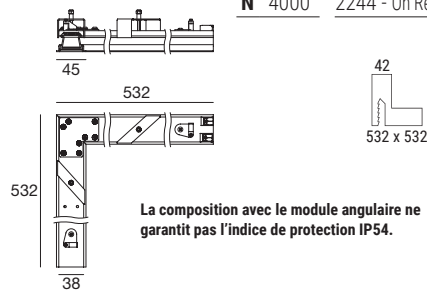

Électronique

99374	99331	99332	83062	99787
ON/OFF	ON/OFF	0/1-10V	DALI	DALI
75 W	150 W	150 W	120 W	120 W
p 210 x l 148 x h 25	p 150 x l 60 x h 35	p 150 x l 60 x h 35	p 191 x l 63 x h 38	p 244 x l 71 x h 38

Rollip35 | Diffuseur en rouleau

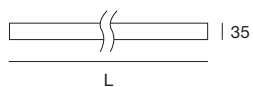

Diffuseur opalin

Opaline	65212	5 m
Opaline	65213	10 m
Opaline	65214	20 m
Opaline	65215	50 m

Diffuseur asymétrique

Opaline	65234	5 m
Opaline	65235	10 m

RTG 65212 / 65213 / 65214 / 65215 / 65234 / 65235

Rollip35 | Gabarit

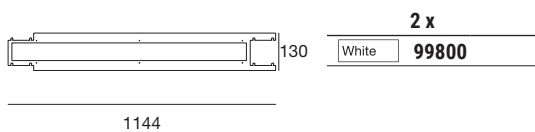

RTG 99800

Rollip35 | Kit de bouchons

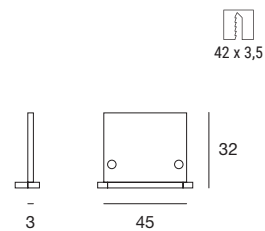
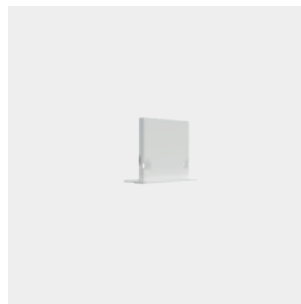

2 x
White **65219**

RTG 65219

Installation with template cod. 99800

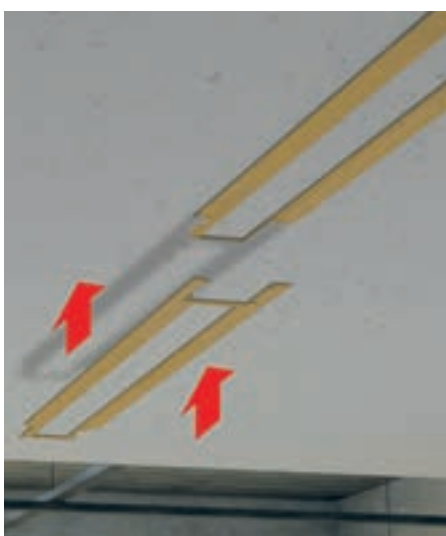

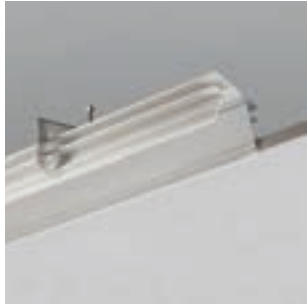

Kit de jonction inclus

1002 mm - 18W DC - CRI 80		Cct	Im S - D
White	65200	W 3000	2544 - On Req
		N 4000	2628 - On Req

1002 mm - 18W DC - CRI 92		Cct	Im S - D
White	65449	W 3000	2064 - On Req
		N 4000	2244 - On Req

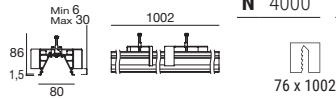

1503 mm - 27W DC - CRI 80		Cct	Im S - D
White	65201	W 3000	3816 - On Req
		N 4000	3942 - On Req

1503 mm - 27W DC - CRI 92		Cct	Im S - D
White	65451	W 3000	3096 - On Req
		N 4000	3366 - On Req

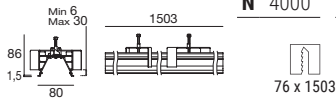

2004 mm - 35W DC - CRI 80		Cct	Im S - D
White	65202	W 3000	5088 - On Req
		N 4000	5256 - On Req

2004 mm - 35W DC - CRI 92		Cct	Im S - D
White	65453	W 3000	4128 - On Req
		N 4000	4488 - On Req

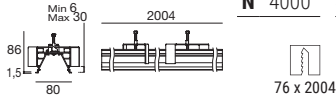

3006 mm - 50W DC - CRI 80		Cct	Im S - D
White	65203	W 3000	7632 - On Req
		N 4000	7884 - On Req

3006 mm - 50W DC - CRI 92		Cct	Im-S	Im-D
White	65455	W 3000	6192 - On Req	
		N 4000	6732 - On Req	

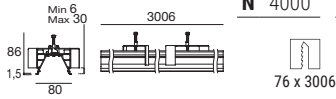

551 x 551mm - 19W DC - CRI 80		Cct	Im S - D
White	65231	W 3000	2544 - On Req
		N 4000	2628 - On Req

551 x 551mm - 19W DC - CRI 92		Cct	Im S - D
White	65457	W 3000	2064 - On Req
		N 4000	2244 - On Req

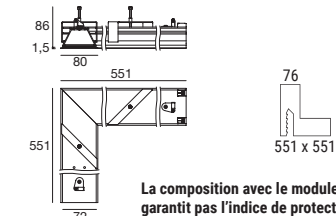

La composition avec le module angulaire ne garantit pas l'indice de protection IP54.



Kit de jonction inclus

1002 mm - 36W DC - CRI 80		Cct	Im S - D
White	65220	W 3000	5088 - On Req
		N 4000	5256 - On Req

1002 mm - 36W DC - CRI 92		Cct	Im S - D
White	65450	W 3000	4128 - On Req
		N 4000	4488 - On Req

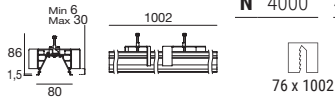

1503 mm - 54W DC - CRI 80		Cct	Im S - D
White	65221	W 3000	7632 - On Req
		N 4000	7884 - On Req

1503 mm - 54W DC - CRI 92		Cct	Im S - D
White	65452	W 3000	6192 - On Req
		N 4000	6732 - On Req

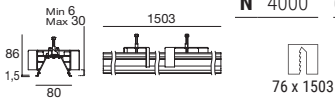

2004 mm - 70W DC - CRI 80		Cct	Im S - D
White	65222	W 3000	10176 - On Req
		N 4000	10512 - On Req

2004 mm - 70W DC - CRI 92		Cct	Im S - D
White	65454	W 3000	8256 - On Req
		N 4000	8976 - On Req

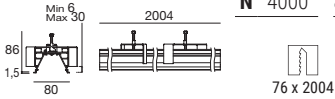

3006 mm - 100W DC - CRI 80		Cct	Im S - D
White	65223	W 3000	15624 - On Req
		N 4000	15768 - On Req

3006 mm - 100W DC - CRI 92		Cct	Im S - D
White	65456	W 3000	12384 - On Req
		N 4000	13464 - On Req

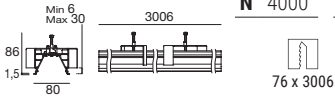

551 x 551mm - 38W DC - CRI 80		Cct	Im S - D
White	65232	W 3000	5088 - On Req
		N 4000	5256 - On Req

551 x 551mm - 38W DC - CRI 92		Cct	Im S - D
White	65458	W 3000	4128 - On Req
		N 4000	4488 - On Req

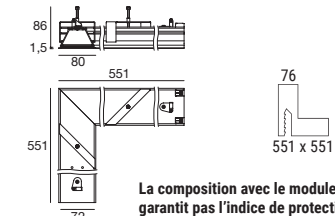

La composition avec le module angulaire ne garantit pas l'indice de protection IP54.

Rollip70 | Diffuseur en rouleau

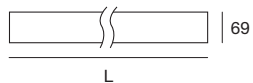

Diffuseur opalin

Opaline	65208	5 m
Opaline	65209	10 m
Opaline	65210	20 m
Opaline	65211	50 m

Diffuseur asymétrique

Opaline	65238	5 m
Opaline	65239	10 m

Diffuseur anti-éblouissement UGR<19

Opaline	65236	5 m
Opaline	65237	10 m

RTG 65208 / 65209 / 65210 / 65211 / 65238 / 65239 / 65236 / 65237

Rollip70 | Kit de bouchons

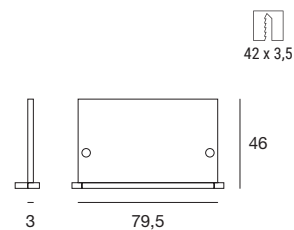
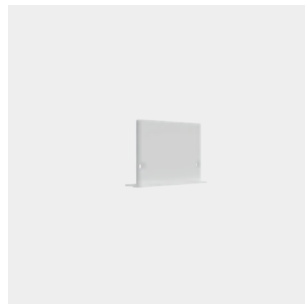

2 x

White **65218**

RTG 65218

Rollip70 | Gabarit

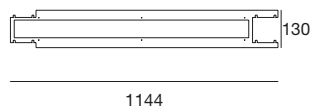

2 x

White **99801**

RTG 99801

Installation with template cod. 99801

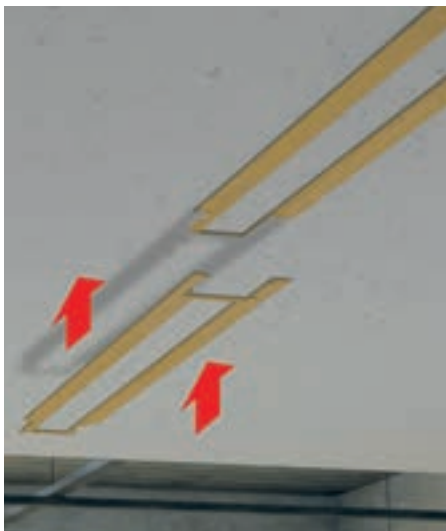

Pag. 310

RTG 65200W / 65201W / 65202W / 65231W

Électronique

99374	99331	99332	83062	99787
ON/OFF 75 W p 210 x l 148 x h 25	ON/OFF 150 W p 150 x l 160 x h 35	0/1-10V 150 W p 150 x l 60 x h 35	DALI 120 W p 191 x l 63 x h 38	DALI 120 W p 244 x l 71 x h 38

Linear System

Rollip35_C | Complete | Lines | 24 V DC | topLED



1216 mm - 23W DC - CRI 80		Cct	lm S - D	Optic
White	65216	W 3000	3053 - On req	00 General (90°)
		N 4000	3154 - On req	
1216 mm - 23W DC - CRI 92		Cct	lm S - D	Optic
White	65459	W 3000	2477 - On req	00 General -
		N 4000	2693 - On req	

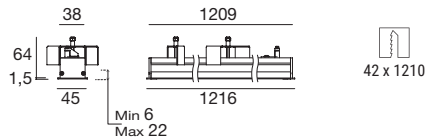

1516 mm - 27W DC - CRI 80		Cct	lm S - D	Optic
White	65217	W 3000	3816 - On req	00 General (90°)
		N 4000	3942 - On req	
1516 mm - 27W DC - CRI 92		Cct	lm S - D	Optic
White	65460	W 3000	3096 - On req	00 General -
		N 4000	3366 - On req	

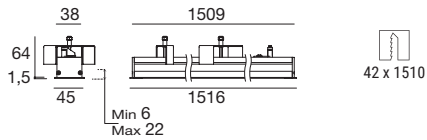

Électronique

99374	99331	99332	83062	99787
ON/OFF 75 W p 210 x 148 x h 25	ON/OFF 150 W p 150 x 160 x h 35	0/1-10V 150 W p 150 x 160 x h 35	DALI 120 W p 191 x 163 x h 38	DALI 120 W p 244 x 171 x h 38

Rollip70_C | Complete | Lines | 24 V DC | topLED



1216 mm - 23W DC - CRI 80		Cct	lm S - D	Optic
White	65225	W 3000	3053 - On req	00 General (123°)
		N 4000	3154 - On req	
1216 mm - 23W DC - CRI 92		Cct	lm S - D	Optic
White	65461	W 3000	2477 - On req	00 General -
		N 4000	2693 - On req	

1216 mm - 46W DC - CRI 80		Cct	lm S - D	Optic
White	65228	W 3000	6360 - On req	00 General (122°)
		N 4000	6570 - On req	
1216 mm - 46W DC - CRI 92		Cct	lm S - D	Optic
White	65462	W 3000	5160 - On req	00 General -
		N 4000	5610 - On req	

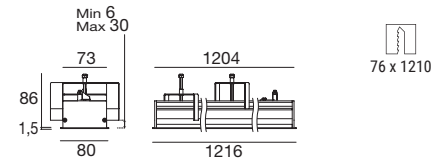

1516 mm - 27W DC - CRI 80		Cct	lm S - D	Optic
White	65226	W 3000	3816 - On req	00 General (123°)
		N 4000	3942vOn req	
1516 mm - 27W DC - CRI 92		Cct	lm S - D	Optic
White	65463	W 3000	3096 - On req	00 General -
		N 4000	3366 - On req	

1516 mm - 54W DC - CRI 80		Cct	lm S - D	Optic
White	65229	W 3000	7632 - On req	00 General (122°)
		N 4000	7884 - On req	
1516 mm - 54W DC - CRI 92		Cct	lm S - D	Optic
White	65464	W 3000	6192 - On req	00 General -
		N 4000	6732 - On req	

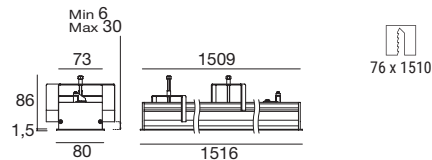

Électronique

99374	99331	99332	83062	99787
ON/OFF 75 W p 210 x 148 x h 25	ON/OFF 150 W p 150 x 160 x h 35	0/1-10V 150 W p 150 x 160 x h 35	DALI 120 W p 191 x 163 x h 38	DALI 120 W p 244 x 171 x h 38



Rollip35_MS | Lines | 220-240 V AC | topLED



1005 mm - 20W AC - CRI 80		DALI 2		Cct		lm S - D	
White	65260	White	65261	W 3000	3000 - On Req		
Black	65292	Black	65293	N 4000	3108 - On Req		
1005 mm - 20W AC - CRI 92		DALI 2		Cct		lm S - D	
White	65497	White	65499	W 3000	2439 - On Req		
Black	65498	Black	65500	N 4000	2654 - On Req		

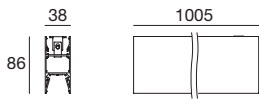

1505 mm - 27W AC - CRI 80		DALI 2		Cct		lm S - D	
White	65262	White	65263	W 3000	4158 - On Req		
Black	65294	Black	65295	N 4000	4307 - On Req		
1505 mm - 27W AC - CRI 92		DALI 2		Cct		lm S - D	
White	65501	White	65503	W 3000	3380 - On Req		
Black	65502	Black	65504	N 4000	3679 - On Req		

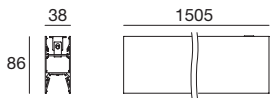

2005 mm - 42W AC - CRI 80		DALI 2		Cct		lm S - D	
White	65264	White	65265	W 3000	6000 - On Req		
Black	65296	Black	65297	N 4000	6216 - On Req		
2005 mm - 42W AC - CRI 92		DALI 2		Cct		lm S - D	
White	65505	White	65507	W 3000	4878 - On Req		
Black	65506	Black	65508	N 4000	5308 - On Req		

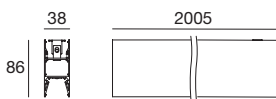

530 x 530 mm - 20W AC - CRI 80		DALI 2		Cct		lm S - D	
White	65266	White	65267	W 3000	3000 - On Req		
Black	65298	Black	65299	N 4000	3108 - On Req		
530 x 530 mm - 20W AC - CRI 92		DALI 2		Cct		lm S - D	
White	65509	White	65511	W 3000	2439 - On Req		
Black	65510	Black	65512	N 4000	2654 - On Req		

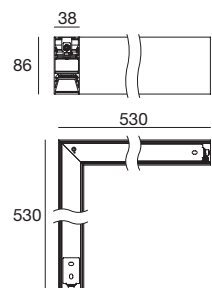

Kit de jonction inclus

314

Rollip35 | Diffuseur en rouleau

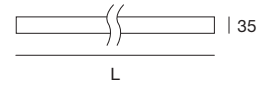

Diffuseur opalin		
Opaline	65212	5 m
Black	64005	5 m
Opaline	65213	10 m
Black	64015	10 m
Opaline	65214	20 m
Black	64025	20 m
Opaline	65215	50 m
Black	64035	50 m

Le diffuseur, avec finition noire, a une perte de rendement de 40 à 50 % par rapport à la version opaline

Diffuseur asymétrique		
Opaline	65234	5 m
Opaline	65235	10 m

RTG 65234 / 65235

Rollip35 | Kit de bouchons

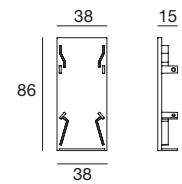

2 x	
White	64634
Black	65291

Rollip60_MS | Lines | 220-240 V | topLED



1005 mm - 20W AC - CRI 80		DALI 2		Cct	lm S - D
White	82079	White	82080	W 3000	2884 - On Req
Black	82570	Black	82571	N 4000	3016 - On Req
1005 mm - 20W AC - CRI 92		DALI 2		Cct	lm S - D
White	65525	White	65527	W 3000	2439 - On Req
Black	65526	Black	65528	N 4000	2654 - On Req

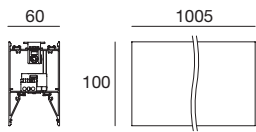

1505 mm - 27W AC - CRI 80		DALI 2		Cct	lm S - D
White	82081	White	82082	W 3000	4158 - On Req
Black	82572	Black	82573	N 4000	4307 - On Req
1505 mm - 27W AC - CRI 92		DALI 2		Cct	lm S - D
White	65529	White	65531	W 3000	3380 - On Req
Black	65530	Black	65532	N 4000	3679 - On Req

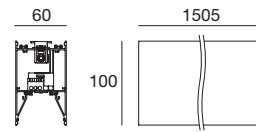

2005 mm - 42W AC - CRI 80		DALI 2		Cct	lm S - D
White	82083	White	82084	W 3000	6000 - On Req
Black	82574	Black	82575	N 4000	6216 - On Req
2005 mm - 42W AC - CRI 92		DALI 2		Cct	lm S - D
White	65533	White	65535	W 3000	4878 - On Req
Black	65534	Black	65536	N 4000	5308 - On Req

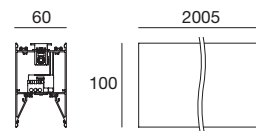

539 x 539 mm - 20W AC - CRI 80		DALI 2		Cct	lm S - D
White	81865	White	81866	W 3000	3000 - On Req
Black	82598	Black	82599	N 4000	3108 - On Req
539 x 539 mm - 20W AC - CRI 92		DALI 2		Cct	lm S - D
White	65537	White	65539	W 3000	2439 - On Req
Black	65538	Black	65540	N 4000	2654 - On Req

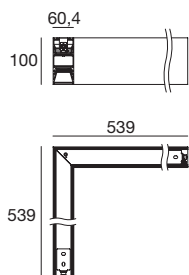

Rollip60 | Diffuseur en rouleau

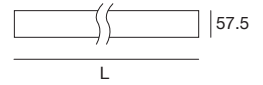

Diffuseur opalin

Opaline	64297	5 m
Black	64006	5 m
Opaline	64298	10 m
Black	64016	10 m
Opaline	64299	20 m
Black	64026	20 m

Le diffuseur, avec finition noire, a une perte de rendement de 40 à 50 % par rapport à la version opaline

Diffuseur anti-éblouissement UGR<19

Opaline	64698	5 m
Opaline	64699	10 m

Rollip60 | Kit de bouchons

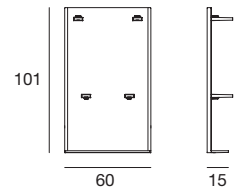

2 x

White	99840
Black	99982

Rollip35_MP | Lines | 220-240 V AC | topLED



1005 mm - 20W AC - CRI 80		DALI 2		Cct		lm S - D	
White	65240	White	65241	W 3000	3000 - On Req		
Black	65272	Black	65273	N 4000	3108 - On Req		

1005 mm - 20W AC - CRI 92		DALI 2		Cct		lm S - D	
White	65465	White	65467	W 3000	2439 - On Req		
Black	65466	Black	65468	N 4000	2654 - On Req		

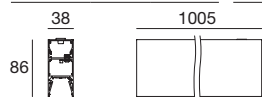

1505 mm - 27W AC - CRI 80		DALI 2		Cct		lm S - D	
White	65242	White	65243	W 3000	4158 - On Req		
Black	65276	Black	65277	N 4000	4307 - On Req		

1505 mm - 27W AC - CRI 92		DALI 2		Cct		lm S - D	
White	65473	White	65475	W 3000	3380 - On Req		
Black	65474	Black	65476	N 4000	3679 - On Req		

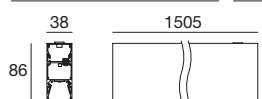

2005 mm - 42W AC - CRI 80		DALI 2		Cct		lm S - D	
White	65244	White	65245	W 3000	6000 - On Req		
Black	65282	Black	65283	N 4000	6216 - On Req		

2005 mm - 42W C - CRI 92		DALI 2		Cct		lm S - D	
White	65481	White	65483	W 3000	4878 - On Req		
Black	65482	Black	65484	N 4000	5308 - On Req		

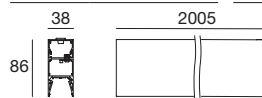

Premier module toujours à intégrer avec kit d'alimentation.
Tous les modules linéaires doivent être complétés par au moins un kit de suspension à installer à l'une des extrémités.

530x530 mm - 20W AC - CRI 80		DALI 2		Cct		lm S - D	
White	65246	White	65247	W 3000	3000 - On Req		
Black	65286	Black	65287	N 4000	3108 - On Req		

530x530 mm - 20W AC - CRI 92		DALI 2		Cct		lm S - D	
White	65489	White	65491	W 3000	2439 - On Req		
Black	65490	Black	65492	N 4000	1654 - On Req		

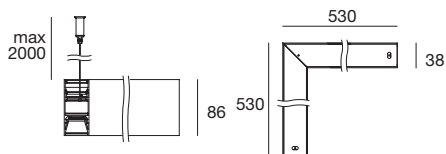

Module non électrifiable.

Rollip35_MP | Lines | 220-240 V AC | topLED



1005 mm - 40W AC - CRI 80		DALI 2		Cct		lm S - D	
White	65248	White	65249	W 3000	6000 - On Req		
Black	65274	Black	65275	N 4000	6216 - On Req		

1005 mm - 40W AC - CRI 92		DALI 2		Cct		lm S - D	
White	65469	White	65471	W 3000	4878 - On Req		
Black	65470	Black	65472	N 4000	5308 - On Req		



1505 mm - 54W AC - CRI 80		DALI 2		Cct		lm S - D	
White	65250	White	65251	W 3000	8316 - On Req		
Black	65278	Black	65279	N 4000	8614 - On Req		

1505 mm - 54W AC - CRI 92		DALI 2		Cct		lm S - D	
White	65477	White	65479	W 3000	6760 - On Req		
Black	65478	Black	65480	N 4000	7358 - On Req		

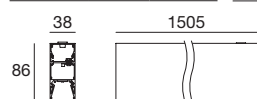

2005 mm - 84W AC - CRI 80		DALI 2		Cct		lm S - D	
White	65252	White	65253	W 3000	12000 - On Req		
Black	65284	Black	65285	N 4000	12432 - On Req		

2005 mm - 84W AC - CRI 92		DALI 2		Cct		lm S - D	
White	65485	White	65487	W 3000	9756 - On Req		
Black	65486	Black	65488	N 4000	10616 - On Req		

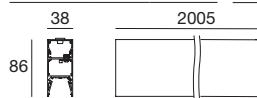

Premier module toujours à intégrer avec kit d'alimentation.
Tous les modules linéaires doivent être complétés par au moins un kit de suspension à installer à l'une des extrémités.

530x530mm - 40W AC - CRI 80		DALI 2		Cct		lm S - D	
White	65254	White	65255	W 3000	6000 - On Req		
Black	65288	Black	65289	N 4000	6216 - On Req		

530x530mm - 40W AC - CRI 92		DALI 2		Cct		lm S - D	
White	65493	White	65495	W 3000	4870 - On Req		
Black	65494	Black	65496	N 4000	5308 - On Req		

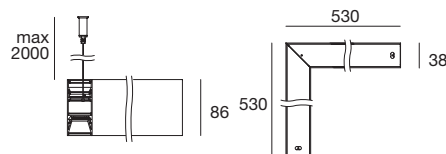

Module non électrifiable.

Rollip35 | Diffuseur en rouleau

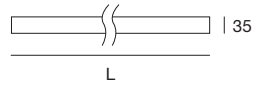

Diffuseur opalin

Opaline	65212	5 m
Black	64005	5 m
Opaline	65213	10 m
Black	64015	10 m
Opaline	65214	20 m
Black	64025	20 m
Opaline	65215	50 m
Black	64035	50 m

Le diffuseur supérieur est livré pré-assemblé avec le module

Le diffuseur, avec finition noire, a une perte de rendement de 40 à 50 % par rapport à la version opaline

Diffuseur asymétrique

Opaline	65234	5 m
Opaline	65235	10 m

Le diffuseur supérieur est livré pré-assemblé avec le module

RTG 65234 / 65235

Rollip35 | Kit de bouchons

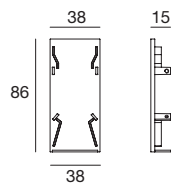

2 x

White	64634
Black	65291

Rollip35 | Kit d'alimentation

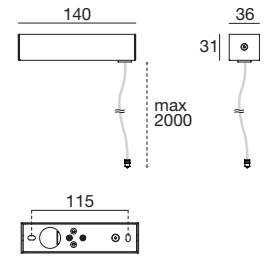

Single emission

White	64639
Black	63300

DALI 2

White	64660
Black	63301

Double emission

White	64649
Black	63302

DALI 2

White	64660
Black	63301

Rollip35_MP | Kit de suspension

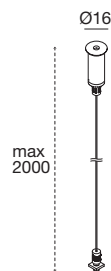

Le kit de suspension comprend un seul câble. Il est nécessaire d'acheter un kit de suspension pour chaque module de l'installation.

Kit de suspension

White	64776	2 m
Black	65290	2 m

65248W

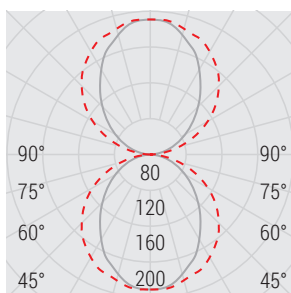

Courbe photométrique

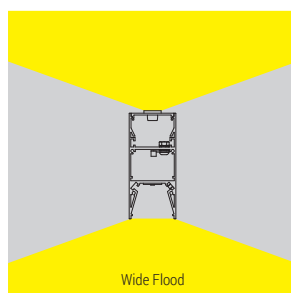

Faisceau lumineux

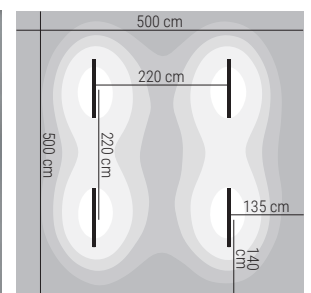
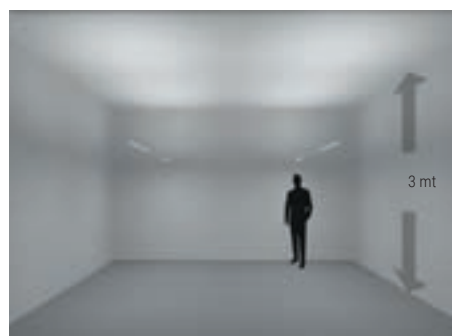

Planimétrie

Rollip7035_MP | Lines | 220-240 V AC | topLED



1005 mm - 20W AC - CRI 80		DALI 2		Cct	lm S - D
White	64272	White	64273	W 3000	3000 - On Req
Black	63945	Black	63946	N 4000	3108 - On Req

1005 mm - 20W AC - CRI 92		DALI 2		Cct	lm S - D
White	65513	White	65514	W 3000	2439 - On Req
Black	62781	Black	62782	N 4000	2654 - On Req

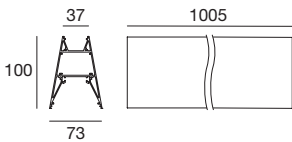

1505 mm - 27W AC - CRI 80		DALI 2		Cct	lm S - D
White	64274	White	64275	W 3000	4158 - On Req
Black	63949	Black	63955	N 4000	4307 - On Req

1505 mm - 27W AC - CRI 92		DALI 2		Cct	lm S - D
White	65517	White	65518	W 3000	3380 - On Req
Black	62785	Black	62786	N 4000	3679 - On Req

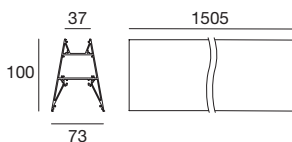

2005 mm - 42W AC - CRI 80		DALI 2		Cct	lm S - D
White	64276	White	64277	W 3000	6000 - On Req
Black	63958	Black	63959	N 4000	6216 - On Req

2005 mm - 42W AC - CRI 92		DALI 2		Cct	lm S - D
White	65521	White	65522	W 3000	4878 - On Req
Black	62789	Black	62791	N 4000	5308 - On Req

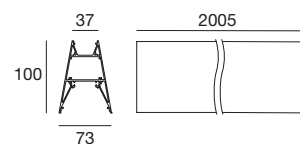

Premier module toujours à intégrer avec kit d'alimentation.
Tous les modules linéaires doivent être complétés par au moins un kit de suspension à installer à l'une des extrémités.

Rollip7035_MP | Lines | 220-240 V AC | topLED



1005 mm - 40W AC - CRI 80		DALI 2		Cct	lm S - D
White	64282	White	64283	W 3000	6000 - On Req
Black	63947	Black	63948	N 4000	6032 - On Req

1005 mm - 40W AC - CRI 92		DALI 2		Cct	lm S - D
White	65515	White	65516	W 3000	4878 - On Req
Black	62783	Black	62784	N 4000	5308 - On Req

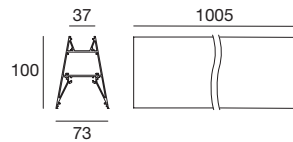

1505 mm - 54W AC - CRI 80		DALI 2		Cct	lm S - D
White	64284	White	64285	W 3000	8316 - On Req
Black	63956	Black	63957	N 4000	8614 - On Req

1505 mm - 54W AC - CRI 92		DALI 2		Cct	lm S - D
White	65519	White	65520	W 3000	6760 - On Req
Black	62787	Black	62788	N 4000	7358 - On Req

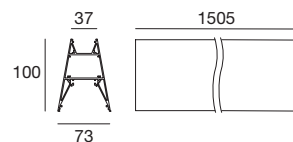

2005 mm - 84W AC - CRI 80		DALI 2		Cct	lm S - D
White	64286	White	64287	W 3000	12000 - On Req
Black	63965	Black	63966	N 4000	12432 - On Req

2005 mm - 84W AC - CRI 92		DALI 2		Cct	lm S - D
White	65523	White	65524	W 3000	9756 - On Req
Black	62792	Black	62793	N 4000	10616 - On Req

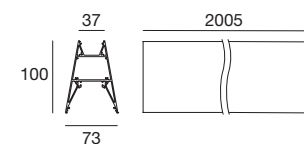

Premier module toujours à intégrer avec kit d'alimentation.
Tous les modules linéaires doivent être complétés par au moins un kit de suspension à installer à l'une des extrémités.

Rollip7035 | Diffuseur en rouleau

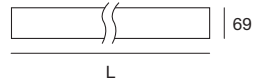

Diffuseur opalin

Opaline	65208	5 m
Black	64045	5 m
Opaline	65209	10 m
Black	64055	10 m
Opaline	65210	20 m
Black	64065	20 m
Opaline	65211	50 m
Black	64075	50 m

Le diffuseur supérieur est livré pré-assemblé avec le module

Le diffuseur, avec finition noire, a une perte de rendement de 40 à 50 % par rapport à la version opaline

Rollip7035 | Kit de bouchons

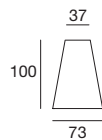

2 x

White	64280
Black	63976

Rollip7035 | Kit d'alimentation

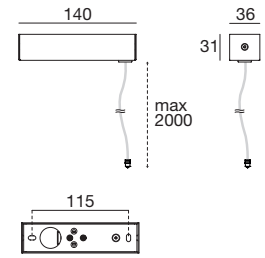

Single emission

White	64639
Black	63300

Double emission

White	64649
Black	63302

DALI 2

White	64660
Black	63301

DALI 2

White	64660
Black	63301

Rollip7035 | Kit de suspension

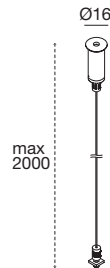

Le kit de suspension comprend un seul câble. Il est nécessaire d'acheter un kit de suspension pour chaque module de l'installation.

Kit de suspension

White	64776	2 m
Black	65290	

Rollip60_MP | Lines | 220-240 V AC | topLED



1005 mm - 20W AC - CRI 80		DALI 2		Cct	lm S - D
White	82085	White	82086	W 3000	3000 - On Req
Black	82576	Black	82577	N 4000	3108 - On Req
1005 mm - 20W AC - CRI 92		DALI 2		Cct	lm S - D
White	65541	White	65543	W 3000	2439 - On Req
Black	65542	Black	65544	N 4000	2654 - On Req

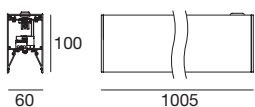

1505 mm - 27W - CRI 80		DALI 2		Cct	lm S - D
White	82087	White	82088	W 3000	4158 - On Req
Black	82578	Black	82579	N 4000	4307 - On Req
1505 mm - 27W - CRI 92		DALI 2		Cct	lm S - D
White	65549	White	65551	W 3000	3380 - On Req
Black	65550	Black	65552	N 4000	3679 - On Req

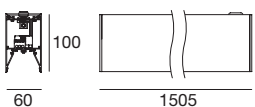

2005 mm - 42W - CRI 80		DALI 2		Cct	lm S - D
White	82089	White	82090	W 3000	6216 - On Req
Black	82580	Black	82581	N 4000	6456 - On Req
2005 mm - 42W - CRI 92		DALI 2		Cct	lm S - D
White	65557	White	65559	W 3000	5064 - On Req
Black	65558	Black	60889	N 4000	5520 - On Req

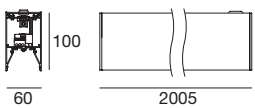

Premier module toujours à intégrer avec kit d'alimentation.
Tous les modules linéaires doivent être complétés par au moins un kit de suspension à installer à l'une des extrémités.

539 x 539 mm - 20W - CRI 80		DALI 2		Cct	lm S - D
White	82101	White	82102	W 3000	3000 - On Req
Black	82592	Black	82593	N 4000	3108 - On Req
539 x 539 mm - 20W - CRI 92		DALI 2		Cct	lm S - D
White	60865	White	60867	W 3000	2439 - On Req
Black	60866	Black	60868	N 4000	2654 - On Req

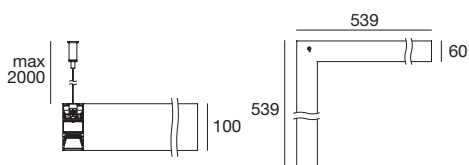

Rollip60_MP | Lines | 220-240 V AC | topLED



1005 mm - 40W AC - CRI 80		DALI 2		Cct	lm S - D
White	82091	White	82092	W 3000	5862 - On Req
Black	82582	Black	82853	N 4000	6072 - On Req
1005 mm - 40W AC - CRI 92		DALI 2		Cct	lm S - D
White	65545	White	65547	W 3000	4767 - On Req
Black	65546	Black	65548	N 4000	5186 - On Req

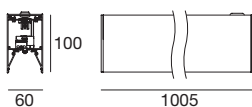

1505 mm - 54W - CRI 80		DALI 2		Cct	lm S - D
White	82093	White	82094	W 3000	8228 - On Req
Black	82584	Black	82585	N 4000	8521 - On Req
1505 mm - 54W - CRI 92		DALI 2		Cct	lm S - D
White	65553	White	65555	W 3000	6692 - On Req
Black	65554	Black	65556	N 4000	7279 - On Req

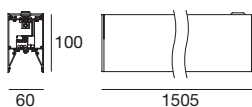

2005 mm - 84W - CRI 80		DALI 2		Cct	lm S - D
White	82095	White	82096	W 3000	12222 - On Req
Black	82586	Black	82587	N 4000	12680 - On Req
2005 mm - 84W - CRI 92		DALI 2		Cct	lm S - D
White	60861	White	60863	W 3000	9941 - On Req
Black	60862	Black	60864	N 4000	10833 - On Req

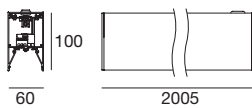

Premier module toujours à intégrer avec kit d'alimentation.
Tous les modules linéaires doivent être complétés par au moins un kit de suspension à installer à l'une des extrémités.

539 x 539 mm - 40 W - CRI 80		DALI 2		Cct	lm S - D
White	82103	White	82104	W 3000	5798 - On Req
Black	82594	Black	82595	N 4000	6007 - On Req
539 x 539 mm - 40 W - CRI 92		DALI 2		Cct	lm S - D
White	83646	White	83648	W 3000	4714 - On Req
Black	83647	Black	83649	N 4000	5131 - On Req

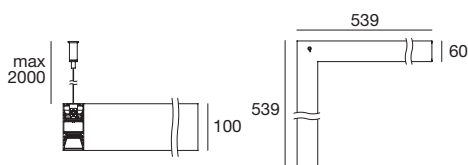

Rollip60 | Diffuseur en rouleau

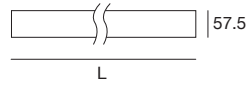

Diffuseur opalin

Opaline	64297	5 m
Black	64006	5 m
Opaline	64298	10 m
Black	64016	10 m
Opaline	64299	20 m
Black	64026	20 m

Le diffuseur supérieur est livré pré-assemblé avec le module

Le diffuseur, avec finition noire, a une perte de rendement de 40 à 50 % par rapport à la version opaline

Diffuseur anti-éblouissement UGR<19

Opaline	64698	5 m
Opaline	64699	10 m

Le diffuseur supérieur est livré pré-assemblé avec le module

Rollip60 | Kit de bouchons

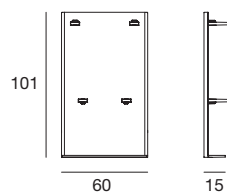

2 x

White	99840
Black	99982

Rollip60 | Kit d'alimentation

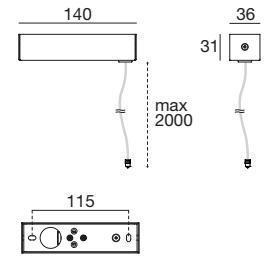

Single emission

White	64639
Black	63300

DALI 2

White	64660
Black	63301

Double emission

White	64649
Black	63302

DALI 2

White	64660
Black	63301

Rollip60_MP | Kit de suspension

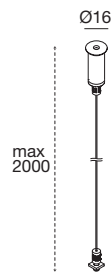

Le kit de suspension comprend un seul câble. Il est nécessaire d'acheter un kit de suspension pour chaque module de l'installation.

Kit de suspension

White	64776	2 m
Black	65290	2 m

Rollip35_PC | Lines | 220-240 V AC | topLED



1211 mm - 46W AC - CRI 80		Cct	lm S - D	Optic
White	65256	W 3000	7296 - On Req	00 Gen+ Gen-
Black	65270	N 4000	7577 - On Req	

DALI 2

White	65257
Black	65271

1211 mm - 46W AC - CRI 92		Cct	lm S - D	Optic
White	60869	W 3000	5947 - On Req	00 Gen+ Gen-
Black	60891	N 4000	6475 - On Req	

DALI 2

White	60871
Black	60872

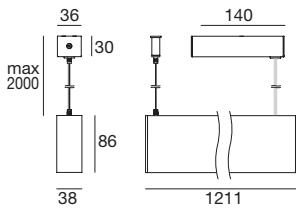

1511 mm - 55W AC - CRI 80		Cct	lm S - D	Optic
White	65258	W 3000	8316 - On Req	00 Gen+ Gen-
Black	65280	N 4000	8614 - On Req	

DALI 2

White	65259
Black	65281

1511 mm - 55W AC - CRI 92		Cct	lm S - D	Optic
White	60873	W 3000	6760 - On Req	00 Gen+ Gen-
Black	60874	N 4000	7358 - On Req	

DALI 2

White	60875
Black	60876

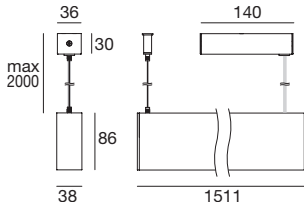

Rollip7035_PC | Lines | 220-240 V AC | topLED



1211 mm - 46W AC - CRI 80		Cct	lm S - D	Optic
White	64288	W 3000	7215 - On Req	00 Gen+UGR-
Black	63967	N 4000	7476 - On Req	

DALI 2

White	64289
Black	63968

1211 mm - 46W AC - CRI 92		Cct	lm S - D	Optic
White	60877	W 3000	5865 - On Req	00 Gen+UGR-
Black	62794	N 4000	6384 - On Req	

DALI 2

White	60878
Black	62795

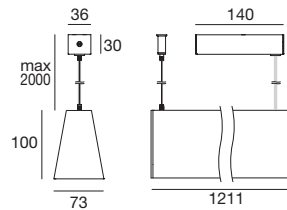

1511 mm - 55W AC - CRI 80		Cct	lm S - D	Optic
White	64278	W 3000	8496 - On Req	00 Gen+UGR-
Black	63969	N 4000	8784 - On Req	

DALI 2

White	64279
Black	63975

1511 mm - 55W AC - CRI 92		Cct	lm S - D	Optic
White	60879	W 3000	6912 - On Req	00 Gen+UGR-
Black	62796	N 4000	7506 - On Req	

DALI 2

White	60892
Black	62797

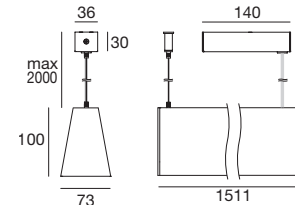

Le diffuseur de Rollip7035_PC complete est UGR sur la partie inférieure et opalin sur la partie supérieure

White



Black

64288N00

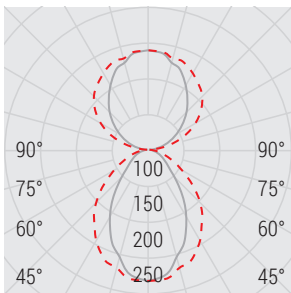

Courbe photométrique

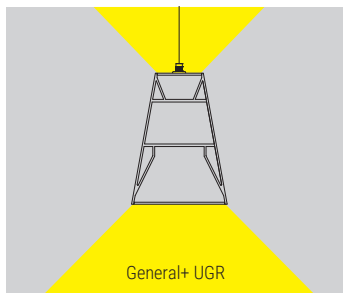

Faisceau lumineux

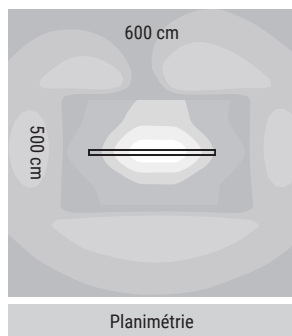
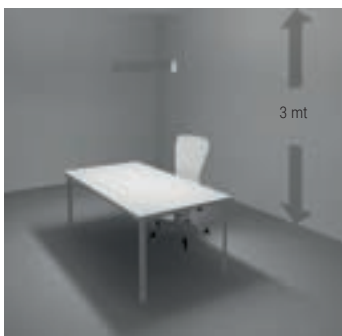

Planimétrie

Rollip60_PC | Lines | 220-240 V AC | topLED



1211 mm - 46W AC - CRI 80		Cct	lm S - D	Optic
White	82097	W 3000	7034 - 0n Req	00 Gen+UGR -
Black	82588	N 4000	7287 - 0n Req	

DALI 2

White	82098
Black	82589

1211 mm - 46W AC - CRI 92		Cct	lm S - D	Optic
White	60881	W 3000	5717 - 0n Req	00 Gen+UGR -
Black	60893	N 4000	6220 - 0n Req	

DALI 2

White	60883
Black	60884

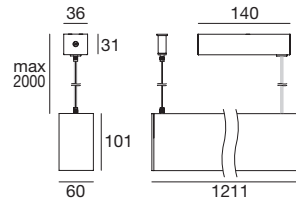

1511 mm - 55W AC - CRI 80		Cct	lm S - D	Optic
White	82099	W 3000	8228 - 0n Req	00 Gen+UGR -
Black	82590	N 4000	8521 - 0n Req	

DALI 2

White	82100
Black	82591

1511 mm - 55W AC - CRI 92		Cct	lm S - D	Optic
White	60885	W 3000	6692 - 0n Req	00 Gen+UGR -
Black	60886	N 4000	7279 - 0n Req	

DALI 2

White	60887
Black	60888

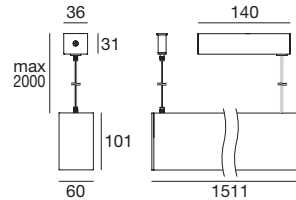

Le diffuseur de Rollip60_PC complete est UGR sur la partie inférieure et opalin sur la partie supérieure



clear

Matériaux

Corps en aluminium

Diffuseur PMMA



clear

Nouveaux modèles des systèmes modulaires

Les nouveautés de 2021 comprennent des éléments de différentes longueurs et formes conçus pour créer un système avec une modularité maximale. Le design des nouveaux modèles Clear_MP a été étudié pour créer une seule fenêtre de lumière suspendue, sans interruption. Les modules angulaires permettent de suivre les configurations des bureaux angulaires.

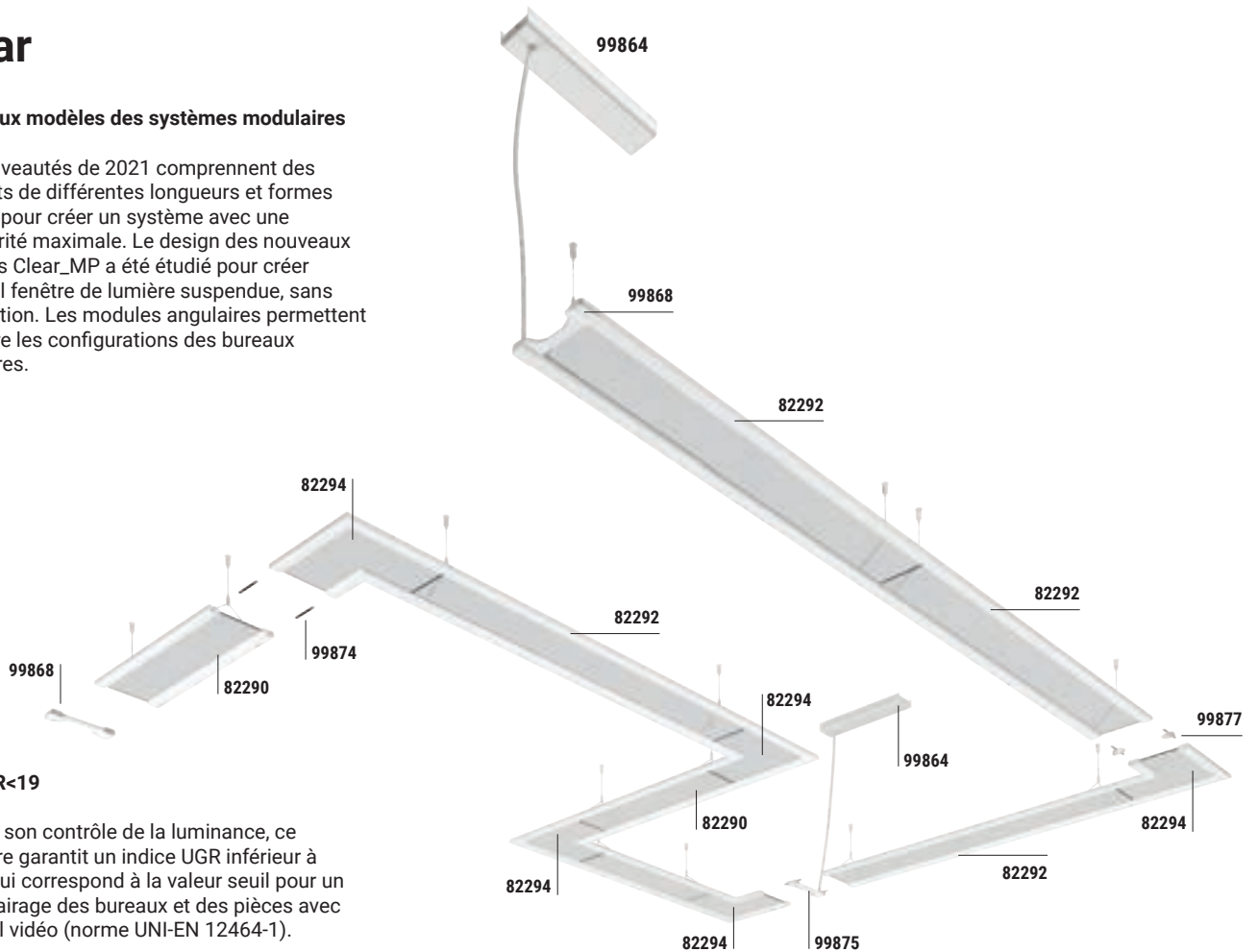

UGR<19

Grâce à son contrôle de la luminance, ce luminaire garantit un indice UGR inférieur à 19, ce qui correspond à la valeur seuil pour un bon éclairage des bureaux et des pièces avec terminal vidéo (norme UNI-EN 12464-1).

OptiLight Technology™ texture à blocs carrés

La surface en PMMA transparent présente une texture spéciale composée de microgravures laser qui dévient les photons émis par la source latérale, en les renvoyant vers le bas et vers le haut. Les micro-gravures des versions modulaires sont agencées en motifs carrés disposés en série, pour s'adapter aux configurations angulaires. Une technologie brevetée Linea Light Group qui maintient la transparence totale du produit lorsqu'il est éteint ; lorsque la lampe est allumée, l'interruption entre une texture et l'autre disparaît et la lampe s'illumine de façon homogène.



Émission directe et indirecte

La solution à double émission est conçue pour assurer une bonne répartition de la lumière dans les deux sens : 55 % de l'émission est uniformément acheminée vers le bas, tandis que les 45 % restants constituent une lumière indirecte permettant un bon éclairage ambiant.

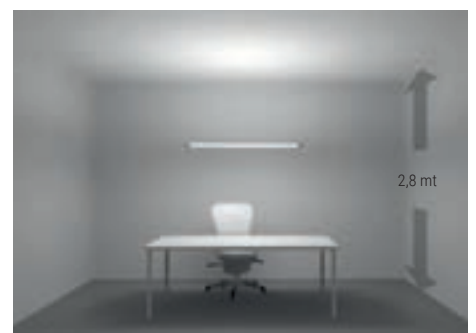
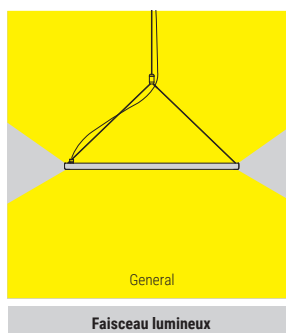

Clear_MP | Suspended luminaires | topLED

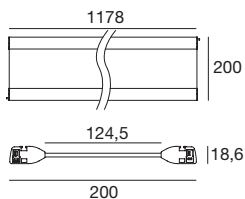

22,5W DC - CRI 92

	Cct	lm S - D	Optic
White	82292	W 3500	3168 - On Req
Black	82293	N 4000	3196 - On Req
			00 General -

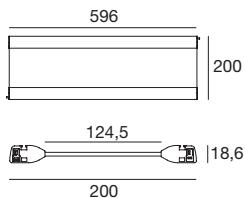

11,25W DC - CRI 92

	Cct	lm S - D	Optic
White	82290	W 3500	1584 - On Req
Black	82291	N 4000	1598 - On Req
			00 General -

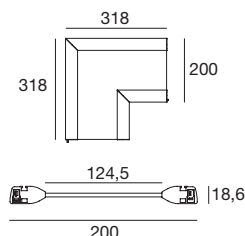

7,5W DC - CRI 92

	Cct	lm S - D	Optic
White	82294	W 3500	1040 - On Req
Black	82295	N 4000	1065 - On Req
			00 General -

Accessoires



1x		description:
White	99868	Élément terminal pour l'alimentation de tête
Black	99869	



1x		description:
White	99875	Élément de jonction électrifé pour l'alimentation intermédiaire
Black	99876	



1x		description:
White	99870	Élément terminal
Black	99871	

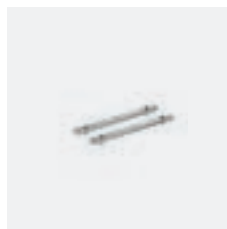

2x		description:
Black	99874	Bride pour le raccordement mécanique des modules



1x		description:
White	99872	Suspension réglable avec balancier
Black	99873	



2x		description:
White	99877	Élément de jonction intermédiaire pour l'interruption de la ligne électrique
Black	99878	



		description:
White	99860	Driver 75W On/Off
Black	99861	



		description:
White	99864	Driver 150W On/Off
Black	99865	

		description:
White	99866	Driver 150W DALI
Black	99867	







mini_albatros

Matériaux

Corps en aluminium

Diffuseur PMMA



mini_albatros range



Mini Albatros

37 W	1135 x 338 mm Stand-alone 1125 x 338 mm Modular
46 W	1414 x 338 mm Stand-alone 1404 x 338 mm Modular
Finish	<input type="checkbox"/> White <input checked="" type="checkbox"/> Grey
CRI 92	3500K - 4000K
Optics	General
Control 	On/Off - DALI

Gestion de l'éclairage

Le profilé en aluminium extrudé contient le driver (ON/OFF ou DALI) et les deux circuits topLED, composés de LED à efficacité élevée pour une émission longitudinale. La lampe garantit des performances de haut niveau grâce à sa puissance et à son rendement lumineux élevé dû à l'excellente répartition du flux qui permet un éclairage moyen de 400 lux sur toute la surface de travail (cas d'un bureau de 80 cm de hauteur éclairé sur toute sa surface de travail).

UGR<19

Grâce à son contrôle de la luminance, ce luminaire garantit un indice UGR inférieur à 19, ce qui correspond à la valeur seuil pour un bon éclairage des bureaux et des pièces avec terminal vidéo (norme UNI-EN 12464-1).



Design et modularité

Le panneau PMMA extra-fin en fait un produit minimaliste et non invasif. Cette caractéristique est particulièrement appréciée dans le cas des installations modulaires : en combinant des modules maîtres et esclaves, il est possible de créer de véritables lignes de lumière capables d'éclairer plusieurs plans de travail simultanément.

Épaisseur minimale y compris avec alimentation DALI

Mini Albatros sont également disponibles avec des alimentations DALI embarquée, tout en conservant une épaisseur minimale conçue pour assurer le meilleur rapport entre design et répartition de la lumière : les modèles Mini Albatros DALI sont épais de 36 mm seulement.

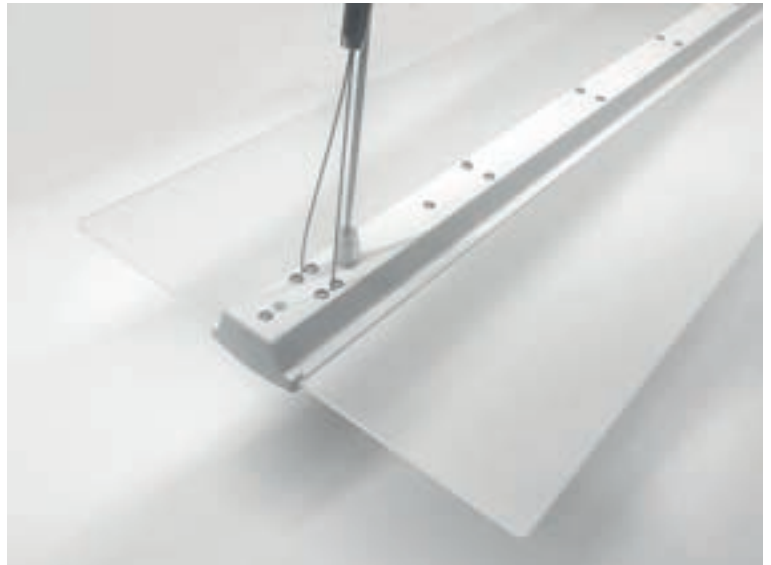

OptiLight Technology™

La surface en PMMA transparent présente une texture spéciale composée de microgravures laser qui dévient les photons émis par la source latérale, en les renvoyant vers le bas et vers le haut. La gravure rayée du bord évite l'éblouissement et améliore le rendement de la lampe.

Une technologie brevetée de Linea Light Group qui maintient la transparence totale du produit lorsqu'il est éteint ; elle génère une lumière douce et sans éblouissement, pour un confort visuel total.

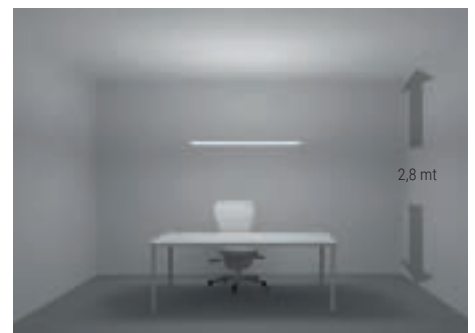
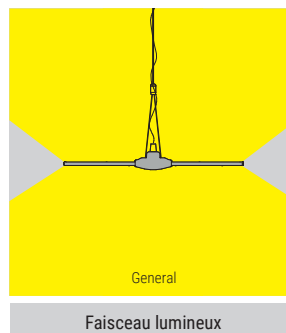

Émission directe et indirecte

La solution à double émission est conçue pour assurer une bonne répartition de la lumière dans les deux sens : 55 % de l'émission est uniformément acheminée vers le bas, tandis que les 45 % restants constituent une lumière indirecte permettant un bon éclairage ambiant.

Mini Albatros | Suspended luminaires | 220-240 V AC | topLED 37 W DC - 44 W AC

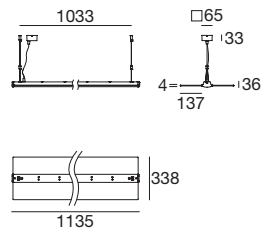

CRI 92	Cct	lm S - D	Optic
White 82834	W 3500	4356 - On req	00 General -
Grey 82835	N 4000	4572 - On req	

CRI 92 - DALI	Cct	lm S - D	Optic
White 82749	W 3500	4356 - On req	00 General -
Grey 82750	N 4000	4572 - On req	

Accessoires Pag. 335

98428 White Ceiling Acc.

98429 Grey Ceiling Acc.

RTG 82749W00 / 82749N00

Mini Albatros | Suspended luminaires | 220-240 V AC | topLED 46 W DC - 55 W AC

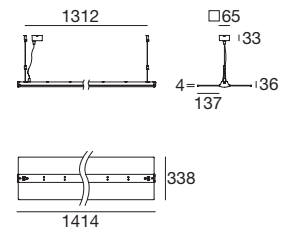

CRI 92	Cct	lm S - D	Optic
White 82836	W 3500	5445 - On req	00 General -
Grey 82837	N 4000	5715 - On req	

CRI 92 - DALI	Cct	lm S - D	Optic
White 82751	W 3500	5445 - On req	00 General -
Grey 82752	N 4000	5715 - On req	

Accessoires Pag. 335

98428 White Ceiling Acc.

98429 Grey Ceiling Acc.

Mini Albatros_M master | Suspended luminaires | 220-240 V AC | topLED 37 W DC - 44 W AC

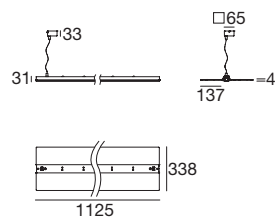

CRI 92	Cct	lm S - D	Optic
White 82838	W 3500	4356 - On req	00 General -
Grey 82839	N 4000	4572 - On req	

CRI 92 - DALI	Cct	lm S - D	Optic
White 82823	W 3500	4356 - On req	00 General -
Grey 82824	N 4000	4572 - On req	

Accessoires Pag. 335

98428 White Ceiling Acc.

98429 Grey Ceiling Acc.

Mini Albatros_M slave | Suspended luminaires | 220-240 V AC | topLED 37 W DC - 44 W AC

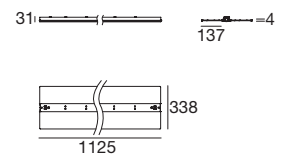

CRI 92	Cct	lm S - D	Optic
White 82842	W 3500	4356 - On req	00 General -
Grey 82843	N 4000	4572 - On req	

CRI 92 - DALI	Cct	lm S - D	Optic
White 82827	W 3500	4356 - On req	00 General -
Grey 82828	N 4000	4572 - On req	

Accessoires Pag. 335

98428 White Ceiling Acc.

98429 Grey Ceiling Acc.

Mini Albatros_M master | Suspended luminaires | 220-240 V AC | topLED 46 W DC - 55 W AC

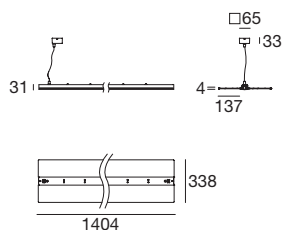

CRI 92	Cct	lm S - D	Optic
White 82840	W 3500	5445 - On req	00 General -
Grey 82841	N 4000	5715 - On req	

CRI 92 - DALI	Cct	lm S - D	Optic
White 82825	W 3500	5445 - On req	00 General -
Grey 82826	N 4000	5715 - On req	

Accessoires Pag. 335

98428 White Ceiling Acc.

98429 Grey Ceiling Acc.

Mini Albatros_M slave | Suspended luminaires | 220-240 V AC | topLED 46 W DC - 55 W AC

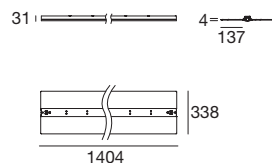

CRI 92	Cct	lm S - D	Optic
White 82844	W 3500	5445 - On req	00 General -
Grey 82845	N 4000	5715 - On req	

CRI 92 - DALI	Cct	lm S - D	Optic
White 82829	W 3500	5445 - On req	00 General -
Grey 82830	N 4000	5715 - On req	

Accessoires Pag. 335

98428 White Ceiling Acc.

98429 Grey Ceiling Acc.

Fixation pour faux plafond

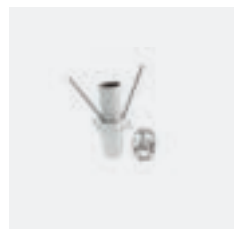

White **98428**
suitable for: Mini Albatros / Mini Albatros_M



Grey **98429**
suitable for: Mini Albatros / Mini Albatros_M

Albatros modular | Exemple d'installation

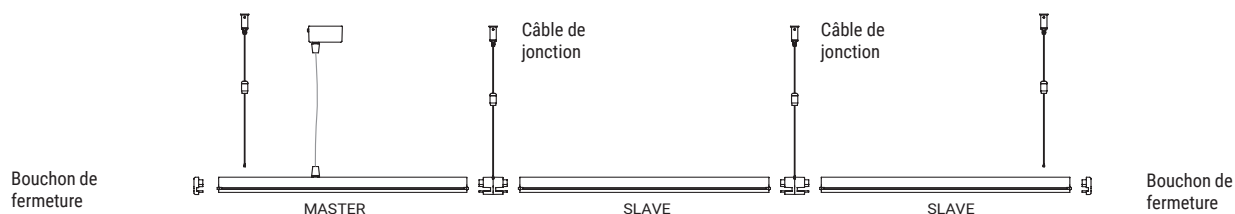
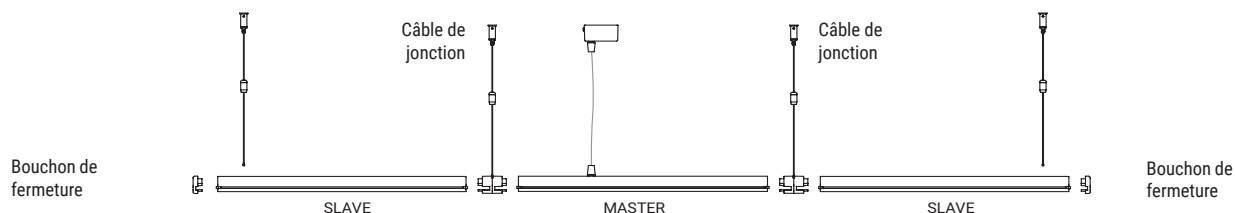

trail

Matériaux

Chassis en acier

Corps en aluminium



Système polyvalent et hautement efficace

Trail offre un éclairage homogène, exempt de contrastes, durable et de qualité, capable de s'adapter à tout environnement d'utilisation : la modularité du système permet, en effet, de créer des configurations sur mesure. L'efficacité énergétique élevée (jusqu'à 176 lm/W) et la maintenance réduite permettent de diminuer les coûts d'utilisation par rapport aux systèmes fluorescents traditionnels.

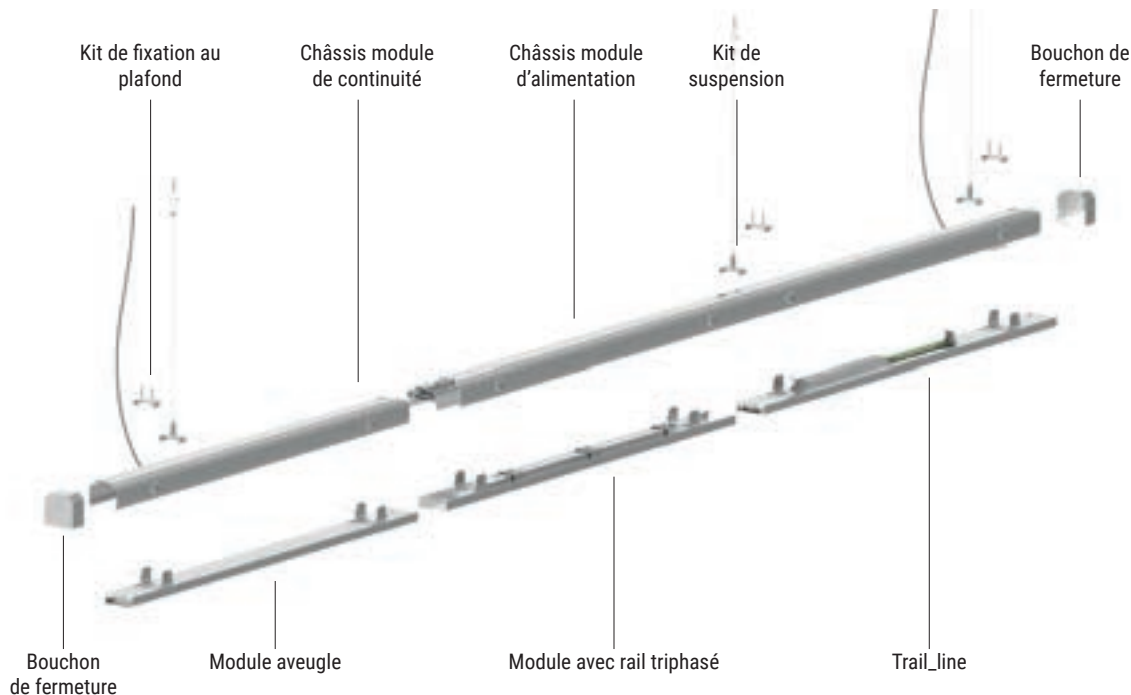

Installation rapide

L'installation d'une ligne continue Trail est simple et rapide : le nouveau système de verrouillage/déverrouillage rapide du carter permet de travailler en toute liberté, sans utiliser d'outils, et de réduire le temps de montage de 45 % par rapport à la version précédente ! Une fois la structure portante installée, le système d'attache rapide permet de personnaliser le positionnement de chaque luminaire pour obtenir l'éclairage le plus adapté et suivre la disposition des éléments dans la pièce.



Large gamme de produits

Trail est un système extrêmement polyvalent proposant diverses solutions. Il est possible de combiner trois niveaux de puissance avec une optique choisie parmi quatre propositions : émission diffuse ; W. Flood à 34° pour des hauteurs élevées et des applications non strictement liées au supermarché ; émission asymétrique simple ou double, pour une lumière dirigée sur une ou deux rangées de produits exposés, conçue pour valoriser visuellement la qualité des articles.

	Asymmetric	D. Asymmetric	General	W. Flood
35 W AC				
47 W AC				
60 W AC				

Trunking system | Module de puissance

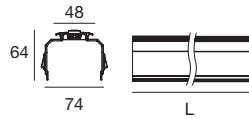

White	90911	1135 mm	ON/OFF	3 pin
White	90915	2270 mm	ON/OFF	3 pin

White	90913	1135 mm	ON/OFF / DALI	7 pin
Black	83653	1135 mm	ON/OFF / DALI	7 pin
White	90917	2270 mm	ON/OFF / DALI	7 pin
Black	83654	2270 mm	ON/OFF / DALI	7 pin

Trunking system | Trail_chassis | Module arrière de continuité

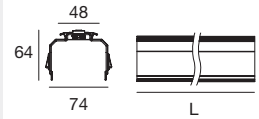

White	90903	1135 mm	ON/OFF	3 pin
White	90907	2270 mm	ON/OFF	3 pin

White	90905	1135 mm	ON/OFF / DALI	7 pin
Black	83651	1135 mm	ON/OFF / DALI	7 pin
White	90909	2270 mm	ON/OFF / DALI	7 pin
Black	83652	2270 mm	ON/OFF / DALI	7 pin

Trunking system | Trail_chassis | Alimentation auxiliaire

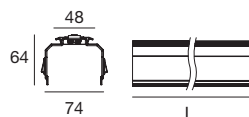

White	90905E	1135 mm	ON/OFF / DALI	7 pin
Black	83655	1135 mm	ON/OFF / DALI	7 pin



White

Black

Trunking system | Trail_line | 220-240 V AC | topLED 34 W DC - 35 W AC

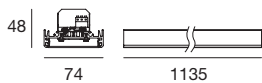

3 pin	Cct	lm S - D	Optic
White 90919	N 4000	5450 - On req	60 W.Flood (34°)
7 pin			00 General (60°)
White 90921			07 Asymm. -
DALI 7 pin			69 D.Asymm. -
White 90923			

Trunking system | Trail_line | 220-240 V AC | topLED 46 W DC - 47 W AC

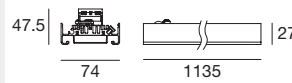

3 pin	Cct	lm S - D	Optic
White 90925	N 4000	7000 - On req	60 W.Flood (34°)
7 pin			00 General (60°)
White 90927			07 Asymm. -
DALI 7 pin			69 D.Asymm. -
White 90929			

Trunking system | Trail_line | 220-240 V AC | topLED 58 W DC - 60 W AC

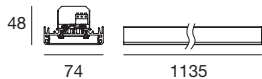

3 pin	Cct	lm S - D	Optic
White 90931	N 4000	5450 - On req	60 W.Flood (34°)
7 pin			00 General (60°)
White 90933			07 Asymm. -
DALI 7 pin			69 D.Asymm. -
White 90935			
Black 83656			

Trunking system | Adaptateur triphasé

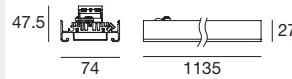

White 90952
Black 83067

Module pour projecteur sur rail.
Charge maximale 3 kg.
Puissance maximale prise en charge 60 W.

Trunking system | Kit de suspension

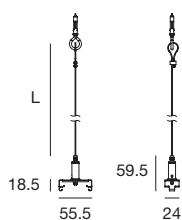

1500 mm **90944**

3000 mm **90943**

Câble en acier réglable à la base, nécessaire pour une installation suspendue et disponible en deux versions : 1,5 m et 3 m.

Interligne fixations 1,5 m

Trunking system | Bouchon de fermeture

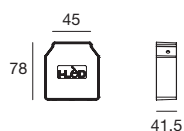

White **90946**

Black **83068**

Bouchon neutre de fermeture ligne.

Trunking system | Kit de fixation au plafond

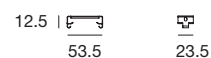

90945

L'installation au plafond nécessite 1x support de fixation en acier. Installer au moins 1 support de fixation tous les 1,5 m de module Trail_châssis.

Trunking system | Couverture

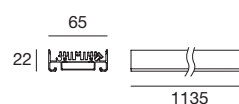

White **90950**

Black **83069**

Module aveugle de couverture.



LATTE FRESCO
YOGURT

2

LATTE UHT
ZUCCHERO

RIFIUTI
CAFFE

3

PRIMA COLAZIONE
PASTINE

INNOVO LOG



ink

Matériaux

Câble conducteur en caoutchouc

Accessoires en aluminium



INK est un système linéaire complet

Ink réévalue le concept d'appareil lumineux, le démonte et le remonte, pour découvrir de nouvelles formes. La lumière s'étire redéfinie, une ligne fine à émission indirecte permet de couvrir et d'illuminer de grandes distances, les mêmes composants associés au profilé extrudé au mur ou au plafond ou encore au nouveau profilé à encastrer, se transforment en chemins lumineux d'intérieur décoratifs. Le câble sert également de conducteur sur lequel il est possible de fixer, dans la partie inférieure, différents éléments lumineux : avec émission diffuse ou UGR<19, projecteurs orientables également avec une optique Focus, et des suspensions.



Ink, c'est un mouvement

Des petites brides à placer au mur ou au plafond ont été ajoutées pour répondre aux demandes de compositions particulières qui permettent au câble de tourner, et après avoir fixé la bande de LED fournie, il est possible de créer des effets lumineux alternatifs.



84017 Clip for curves

Ink est garni d'accessoires

Le système Ink utilise de nouveaux dispositifs et accessoires qui en optimisent la versatilité et fonctionnalité. Trois nouveaux projecteurs ont été ajoutés : 6W, 12W, 12W Focus, 22W pensés pour satisfaire aux exigences de l'éclairage fonctionnel. En complément des éléments linéaires, un diffuseur cylindrique horizontal (900, 1200 mm), émet une lumière diffuse bien équilibrée. Une nouvelle solution sur rail électrifié à encastrer va de pair avec le système existant, en permettant de combiner l'éclairage indirect avec l'éclairage d'appoint.



Ink n'est que lumière

Le système INK introduit un nouvel élément modulaire pour enrichir cette vaste gamme qui l'a rendu célèbre. Un nouveau profilé de forme cylindrique en polycarbonate pouvant alterner les versions On/Off et Dali point à point, disponible pour encastrement au plafond ou suspension, le module avec source lumineuse à 360 ° permet de créer de multiples solutions grâce aux différentes longueurs du profilé.

83943 Ink system_L
linear module 360°

83949 Ink system_LP
linear module 360°



Ink system_cable | Câble

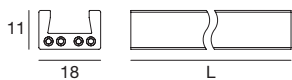

Black	81410	5+1 m
Black	81411	10+1 m
Black	84016*	1 m

*Exemple: **84016** x 13 pièces: câble sur bobine d'une longueur totale de 13 mètres
Seulement pour fixation à la surface ou encastrée (non à suspension).

RTG 81410 / 81411 / 84016

Ink system | Mur / plafond extrudé

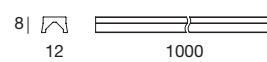
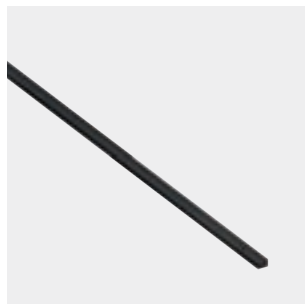

Black	81430	Kit 2 x
Black	81426	Kit 5 x

RTG 81430 / 81426

Ink system_light units | LED Strips

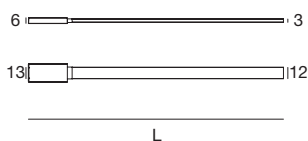

CRI 92 - Basic 3,2 W/mt DC	Cct	lm S - D	Optic
82946 1 m	W 3000	404 - 271	00 General (121°)
82947 2,5 m	W 3000	1011 - 677	
82948 5 m	W 3000	2022 - 1354	

CRI 92 - Hi-Flux 12,6 W/mt DC	Cct	lm S - D	Optic
82949 1 m	W 3000	1510 - 1138	00 General (121°)
82950 2,5 m	W 3000	3777 - 2845	
82951 5 m	W 3000	7544 - 5690	

RTG 82946W00 / 82947W00 / 82948W00
82949W00 / 82950W00 / 82951W00

Ink system_light units | LED Strips

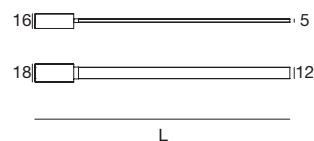

CRI 92 - Basic 3,2 W/mt DC	Cct	lm S - D	Optic
83987 1 m	W 3000	404 - 271	00 General (121°)
83988 2,5 m	W 3000	1010 - 677	
83989 5 m	W 3000	2020 - 1354	

CRI 92 - Hi-Flux 12,6 W/mt DC	Cct	lm S - D	Optic
83990 1 m	W 3000	1510 - 1138	00 General (121°)
83991 2,5 m	W 3000	3777 - 2845	
83992 5 m	W 3000	7544 - 5690	

RTG 83987W00 / 83988W00 / 83989W00
83990W00 / 83991W00 / 83992W00

Ink system_L | Module linéaire diffuse

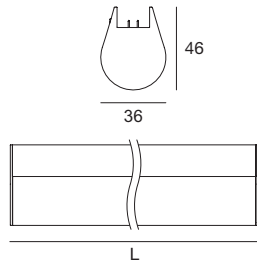

CRI 92 - 11W DC - L 300 mm	Cct	lm S - D	Optic
Black 83943	W 3000	1040 - 652	00 General (158°)
CRI 92 - 22W DC - L 600 mm			
Black 83944	W 3000	2081 - 1350	00 General (158°)
CRI 92 - 33W DC - L 900 mm			
Black 83945	W 3000	3120 - 1985	00 General (158°)



CRI 92 - 11W DC - L 300 mm	Cct	lm S - D	Optic
Black 83972	W 3000	1040 - 652	00 General (158°)
CRI 92 - 22W DC - L 600 mm			
Black 83973	W 3000	2081 - 1350	00 General (158°)
CRI 92 - 33W DC - L 900 mm			
Black 83974	W 3000	3120 - 1985	00 General (158°)

RTG 83943W00 / 83944W00 / 83945W00
83972W00 / 83973W00 / 83974W00

Ink system_L | Module linéaire

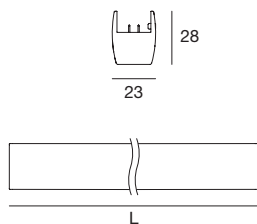

CRI 92 - 11W DC - L 300 mm	Cct	lm S - D	Optic
Black 82914	W 3000	1040 - 396	00 General (110°)
CRI 92 - 22W DC - L 600 mm			
Black 82916	W 3000	2081 - 791	00 General (110°)



CRI 92 - 11W DC - L 300 mm	Cct	lm S - D	Optic
Black 83968	W 3000	1040 - 396	00 General (110°)
CRI 92 - 22W DC - L 600 mm			
Black 83969	W 3000	2081 - 791	00 General (110°)

RTG 82914W00 / 82916W00 / 83968W00 / 83969W00

Ink system_L UGR | Module linéaire anti-éblouissement

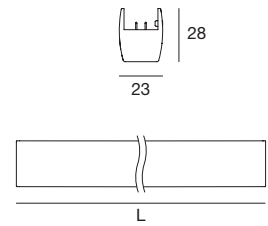

CRI 92 - 7W DC - L 300 mm	Cct	lm S - D	Optic
Black 82918	W 3000	641 - 260	30 Flood (35°)
CRI 92 - 14W DC - L 600 mm			
Black 82920	W 3000	1282 - 520	30 Flood (35°)



CRI 92 - 7W DC - L 300 mm	Cct	lm S - D	Optic
Black 83970	W 3000	641 - 260	30 Flood (35°)
CRI 92 - 14W DC - L 600 mm			
Black 83971	W 3000	1282 - 520	30 Flood (35°)

RTG 82918W30 / 82920W30 / 83970W30 / 83971W30

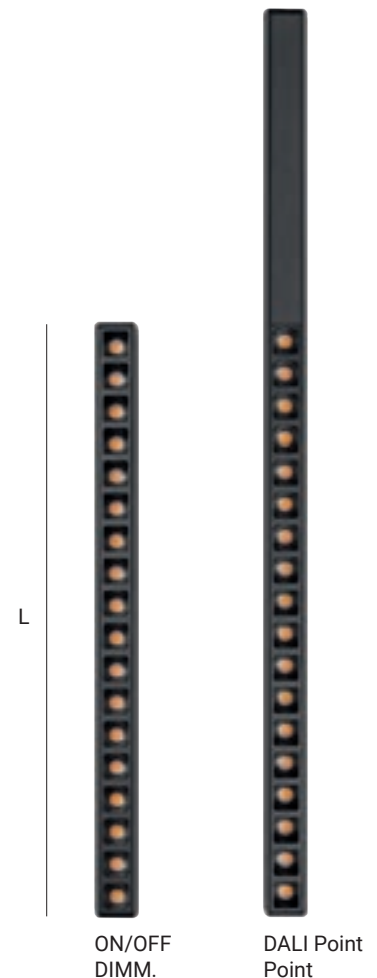

Ink system_LP | Suspension linéaire 360°

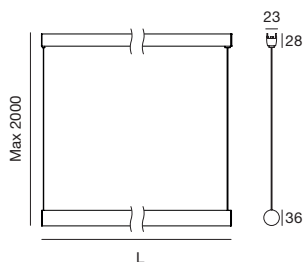

CRI 92 - 27W DC - L 900 mm	Cct	lm S - D	Optic
Black 83949	W 3000	3180 - 1983	00 General (360°)
CRI 92 - 35W DC - L 1200 mm			
Black 83950	W 3000	4063 - 2560	00 General (360°)

RTG 83949W00 / 83950W00

Ink system_LP | Suspension linéaire

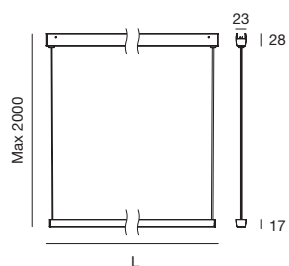
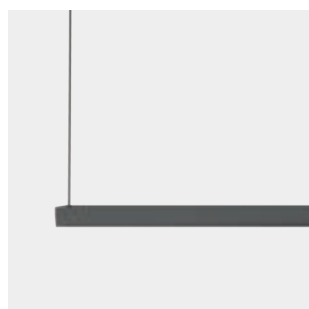

CRI 92 - 22W DC - L 900 mm	Cct	lm S - D	Optic
Black 82928	W 3000	2081 - 738	00 General (97°)
CRI 92 - 29W DC - L 1200 mm			
Black 82930	W 3000	2744 - 950	00 General (97°)



CRI 92 - 22W DC - L 900 mm	Cct	lm S - D	Optic
Black 83980	W 3000	2081 - 738	00 General (97°)
CRI 92 - 29W DC - L 1200 mm			
Black 83981	W 3000	2744 - 950	00 General (97°)

RTG 82928W00 / 82930W00 / 83980W00 / 83981W00

Ink system_LP UGR | Suspension linéaire anti-éblouissement

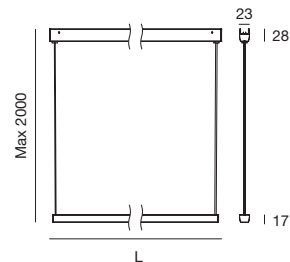

CRI 92 - 9W DC - L 900 mm	Cct	lm S - D	Optic
Black 82932	W 3000	781 - 275	30 W.Flood (46°)
CRI 92 - 12W DC - L 1200 mm			
Black 82944	W 3000	1041 - 377	30 W.Flood (46°)



CRI 92 - 9W DC - L 900 mm	Cct	lm S - D	Optic
Black 83982	W 3000	781 - 275	30 W.Flood (46°)
CRI 92 - 12W DC - L 1200 mm			
Black 83983	W 3000	1041 - 377	30 W.Flood (46°)

RTG 82932W30 / 82944W30 / 83982W30 / 83983W30

Ink system_P | Suspension

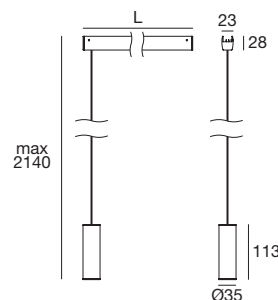
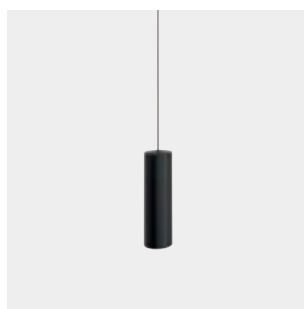
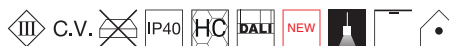

CRI 92 - 6W DC - L 104 mm	Cct	lm-S	lm-D	Optic
Black 82926	W 3000	709 - 468		45 W.Flood (47°)



CRI 92 - 6W DC - L 225 mm	Cct	lm S - D	Optic
Black 83979	W 3000	709 - 468	45 W.Flood (47°)

RTG 82926W45 / 83979W45

Ink system_SP | Projecteur

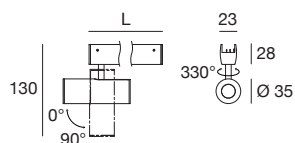
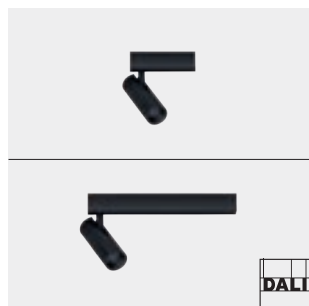

CRI 92 - 6W DC - L 104mm	Cct	lm S - D	Optic
Black 82922	W 3000	709 - 440	10 Spot (21°) 30 Flood (31°) 45 Flood (41°)



CRI 92 - 6W DC - L 225mm	Cct	lm S - D	Optic
Black 83975	W 3000	709 - 440	10 Spot (21°) 30 Flood (31°) 45 Flood (41°)

RTG 82922W10 / 82922W30 / 82922W45
83975W10 / 83975W30 / 83975W45

Ink system_SP Focus | Projecteur

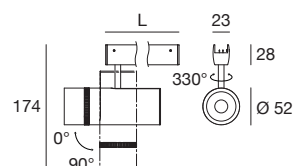

CRI 92 - 12W DC - L 104mm	Cct	lm S - D	Optic
Black 83947	W 3000	1234 - 1034	85 Adj. (16°-33°)



CRI 92 - 12W DC - L 225mm	Cct	lm S - D	Optic
Black 83977	W 3000	1234 - 1034	85 Adj. (16°-33°)

RTG 83947W85 / 83977W85

Ink system_SP | Projecteur

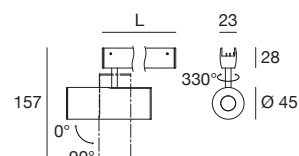
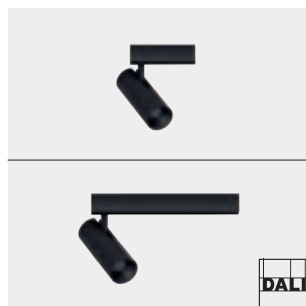

CRI 92 - 12W DC - L 104mm	Cct	lm S - D	Optic
Black 83946	W 3000	1068 - 675	10 Spot (18°) 30 Flood (32°) 45 W.Flood (48°)



CRI 92 - 12W DC - L 225mm	Cct	lm S - D	Optic
Black 83976	W 3000	1068 - 675	10 Spot (18°) 30 Flood (32°) 45 W.Flood (48°)

RTG 83946W10 / 83946W30 / 83946W45
83976W10 / 83976W30 / 83976W45

Ink system_SP | Projecteur

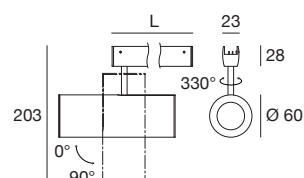

CRI 92 - 22W DC - L 114mm	Cct	lm S - D	Optic
Black 83948	W 3000	2534 - 1976	20 Spot (20°) 35 Flood (35°) 60 W.Flood (62°)



CRI 92 - 22W DC - L 225mm	Cct	lm S - D	Optic
Black 83978	W 3000	2534 - 1976	20 Spot (20°) 35 Flood (35°) 60 W.Flood (62°)

RTG 83948W20 / 83948W35 / 83948W60
83978W20 / 83978W35 / 83978W60

Ink system | Mur / plafond Profilé encastrable

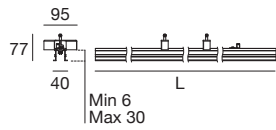

Black	84012	1000 mm
Black	84013	2000 mm
Black	84014	3000 mm

Ink system | Coin encastrable

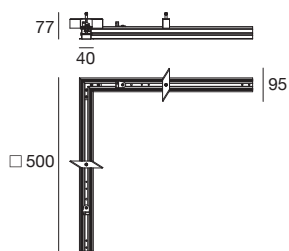

Black **84015**



81419
Inclus

Ink system | Coin-OUT encastrable

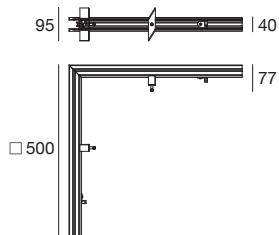

Black **84074**

Ink system_cable | Câble

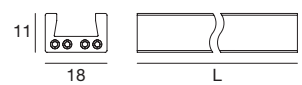

Black	81410	5+1 m
Black	81411	10+1 m
Black	84016*	1 m

*Exemple: **84016**x13 pièces: câble sur bobine d'une longueur totale de 13 mètres
Seulement pour fixation à la surface ou encastrée (non à suspension).

RTG **81410 / 81411 / 84016**

Ink system | Coin-IN encastrable

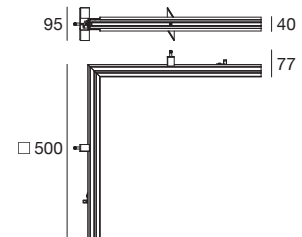

Black **84073**

Ink system | Cache de fermeture



2 x
Black **83153**



81421
Inclus

Système à encastrer Ink

La nouvelle fonctionnalité du système Ink permet d'utiliser le profilé encastrable dans trois dimensions différentes :

- **84012** 1000 mm
- **84013** 2000 mm
- **84014** 3000 mm

le câble est placé dans le profilé. Disponible dans les dimensions habituelles et dans une nouvelle version sur demande:

- **81410** 5000 mm
- **81411** 10000 mm
- **84016*** sur demande

* Exemple : **84016** x 13 pièces : câble sur bobine d'une longueur totale de 13 mètres
Seulement pour fixation à la surface ou encastrée (non à suspension).



Modules de fixation encastrable

Les nouveaux modules encastrables proposent un nouveau système de fixation garantissant stabilité et sécurité. La clé Allen livrée avec les modules, permet d'encastrer l'appareil très simplement.



Ink system_L UGR | Module linéaire anti-éblouissement encastré

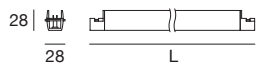

CRI 92 - 7W DC - L 300 mm	Cct	lm S - D	Optic
Black 83954	W 3000	641 - 260	30 Flood (35°)
CRI 92 - 14W DC - L 600 mm			
Black 83955	W 3000	1282 - 520	30 Flood (35°)



CRI 92 - 7W DC - L 300 mm	Cct	lm S - D	Optic
Black 83995	W 3000	641 - 260	30 Flood (35°)
CRI 92 - 14W DC - L 600 mm			
Black 83996	W 3000	1282 - 520	30 Flood (35°)

Ink system_L | Module linéaire encastré

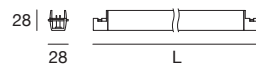

CRI 92 - 11W DC - L 300 mm	Cct	lm S - D	Optic
Black 83952	W 3000	1040 - 396	00 General (110°)
CRI 92 - 22W DC - L 600 mm			
Black 83953	W 3000	2081 - 791	00 General (110°)



CRI 92 - 11W DC - L 300 mm	Cct	lm S - D	Optic
Black 83993	W 3000	1040 - 396	00 General (110°)
CRI 92 - 22W DC - L 600 mm			
Black 83994	W 3000	2081 - 791	00 General (110°)

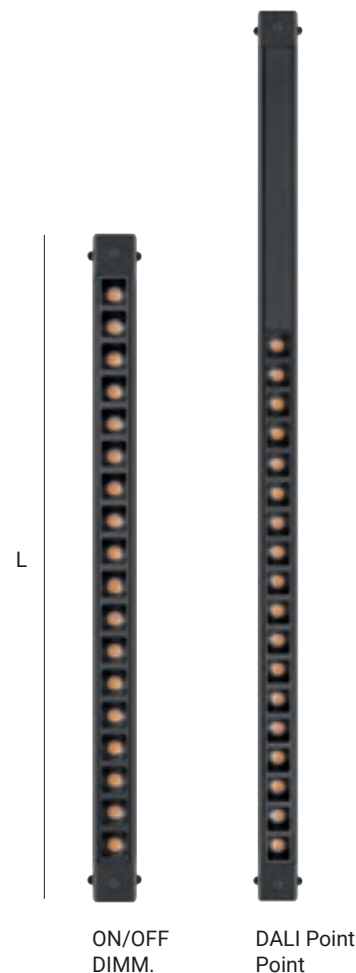



Ink system_LP | Suspension linéaire 360° encastrée

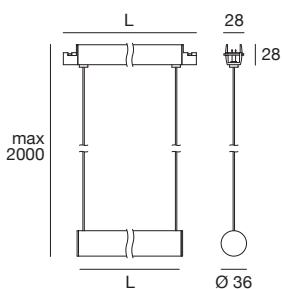

CRI 92 - 27W DC - L 900 mm	Cct	lm S - D	Optic
Black 83965	W 3000	3180 - 1983	00 General (360°)
CRI 92 - 35W DC - L 1200 mm			
Black 83966	W 3000	4063 - 2560	00 General (360°)

Ink system_LP UGR | Suspension linéaire antiréfléchissante encastrée

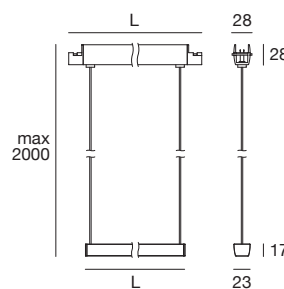
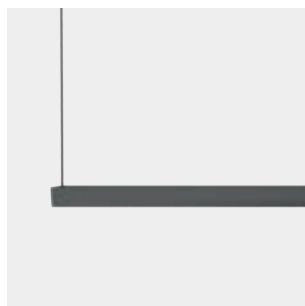

CRI 92 - 9W DC - L 900 mm	Cct	lm S - D	Optic
Black 83963	W 3000	781 - 275	30 W.Flood (46°)
CRI 92 - 12W DC - L 1200 mm			
Black 83964	W 3000	1041 - 377	30 W.Flood (46°)



CRI 92 - 9W DC - L 900 mm	Cct	lm S - D	Optic
Black 84004	W 3000	781 - 275	30 W.Flood (46°)
CRI 92 - 12W DC - L 1200 mm			
Black 84005	W 3000	1041 - 377	30 W.Flood (46°)

Ink system_LP | Suspension linéaire encastrée

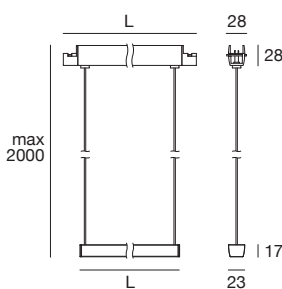
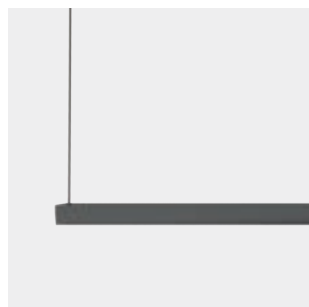

CRI 92 - 22W DC - L 900 mm	Cct	lm S - D	Optic
Black 83961	W 3000	2081 - 738	00 General (97°)
CRI 92 - 29W DC - L 1200 mm			
Black 83962	W 3000	2744 - 950	00 General (97°)



CRI 92 - 22W DC - L 900 mm	Cct	lm S - D	Optic
Black 84002	W 3000	2081 - 738	00 General (97°)
CRI 92 - 29W DC - L 1200 mm			
Black 84003	W 3000	2744 - 950	00 General (97°)

Ink system_P | Suspension encastrée

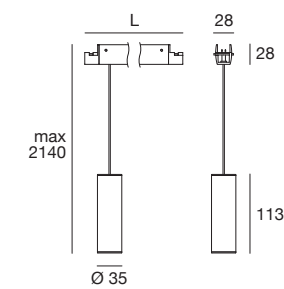
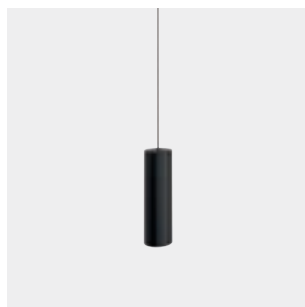
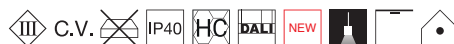

CRI 92 - 6W DC - L 141 mm	Cct	lm S - D	Optic
Black 83960	W 3000	709 - 468	45 W.Flood (47°)



CRI 92 - 6W DC - L 262 mm	Cct	lm S - D	Optic
Black 84001	W 3000	709 - 468	45 W.Flood (47°)

Ink system_SP | Spot encastré

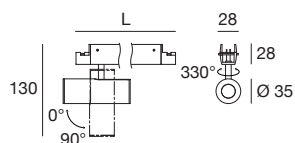

CRI 92 - 6W DC - L 141 mm		Cct	lm S - D	Optic
Black	83956	W 3000	709 - 440	10 Spot (21°) 30 Flood (31°) 45 Flood (41°)



CRI 92 - 6W DC - L 262 mm		Cct	lm S - D	Optic
Black	83997	W 3000	709 - 440	10 Spot (21°) 30 Flood (31°) 45 Flood (41°)

Ink system_SP | Spot encastré

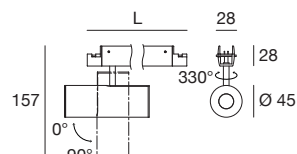

CRI 92 - 12W DC - L 141 mm		Cct	lm S - D	Optic
Black	83957	W 3000	1068 - 675	10 Spot (18°) 30 Flood (32°) 45 Flood (48°)



CRI 92 - 12W DC - L 262 mm		Cct	lm S - D	Optic
Black	83998	W 3000	1068 - 675	15 Spot (18°) 30 Flood (32°) 45 Flood (48°)

Ink system_SP Focus | Spot encastré

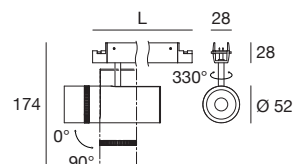

CRI 92 - 12W DC - L 141 mm		Cct	lm S - D	Optic
Black	83958	W 3000	1234 - 1034	85 Spot (16°-33°)



CRI 92 - 12W DC - L 262 mm		Cct	lm S - D	Optic
Black	83999	W 3000	1234 - 1034	85 Spot (16°-33°)

Ink system_SP | Spot encastré

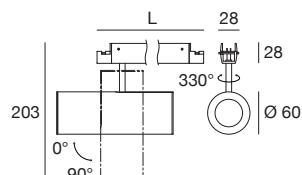

CRI 92 - 22W DC - L 151 mm		Cct	lm S - D	Optic
Black	83959	W 3000	2534 - 1976	20 Spot (20°) 35 Flood (35°) 60 Flood (62°)



CRI 92 - 22W DC - L 262 mm		Cct	lm S - D	Optic
Black	84000	W 3000	2534 - 1976	20 Spot (20°) 35 Flood (35°) 60 Flood (62°)

Ink system | ON/OFF driver avec couvercle

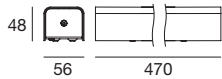

Black	81413	120 W
Black	81414	180 W

RTG 81413 / 81414

Ink system | 220-250 V | AC Remote ON/OFF driver



White	81416	120 W	300 mm
White	81417	180 W	345 mm

RTG 81416 / 81417

Ink system | DALI PUSH converter

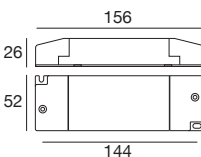

White	83042	180 W
-------	--------------	-------

RTG 83042

Ink system | Boîte de dérivation

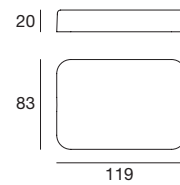
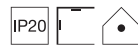

Black	81424
-------	--------------

RTG 81424

Ink system | DALI PUSH converter

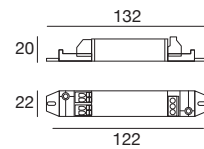

White	83041	120 W
-------	--------------	-------

RTG 83041

Ink system | Remote MASTER DALI driver

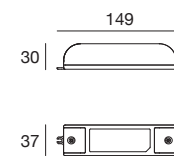
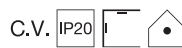

White	84018	150 W
-------	--------------	-------



Ink system | Raccord en croix

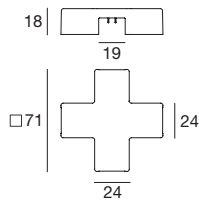

Black **81418**

Ink system | Raccord en L

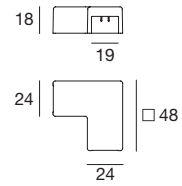

Black **81419**

Ink system | Raccord en T

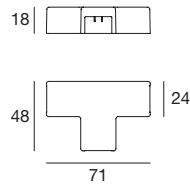

Black **81420**

Ink system | Bouchon de fermeture mur/plafond



Black **81421**

Ink system | Étrier de montage 60 x 60

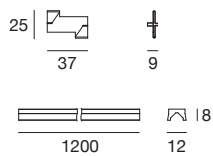

Kit

84010 3 étriers et 2 profilés

84011 3 étriers et 2 profilés



Ink system | Clip pour courbes

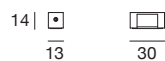

2 x

Black **84017**



Ink system | Fixation sur plaque de plâtre

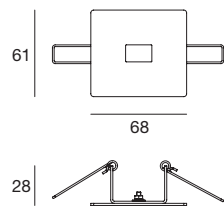

Black **81422** 2 x kit

RTG **81422**

Ink system | Support et câble en acier

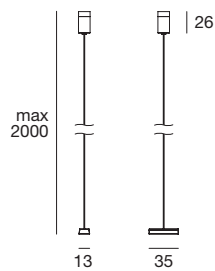
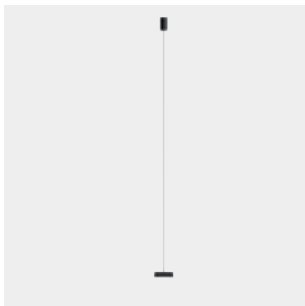

Black **81425**

Ink system | Cisaillement du câble



81427

Ink system | Fixation murale articulée

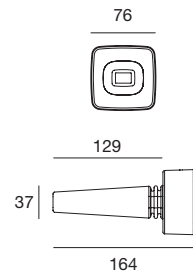
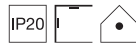

Black **81423** 2 x kit

RTG **81423**

Ink system | Gabarit

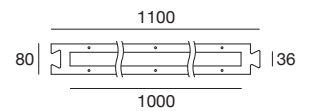

Black **83186**



fylo+

Matériaux

Profilé en aluminium

Résines en poudre de quartz et matériau
de construction mélangé

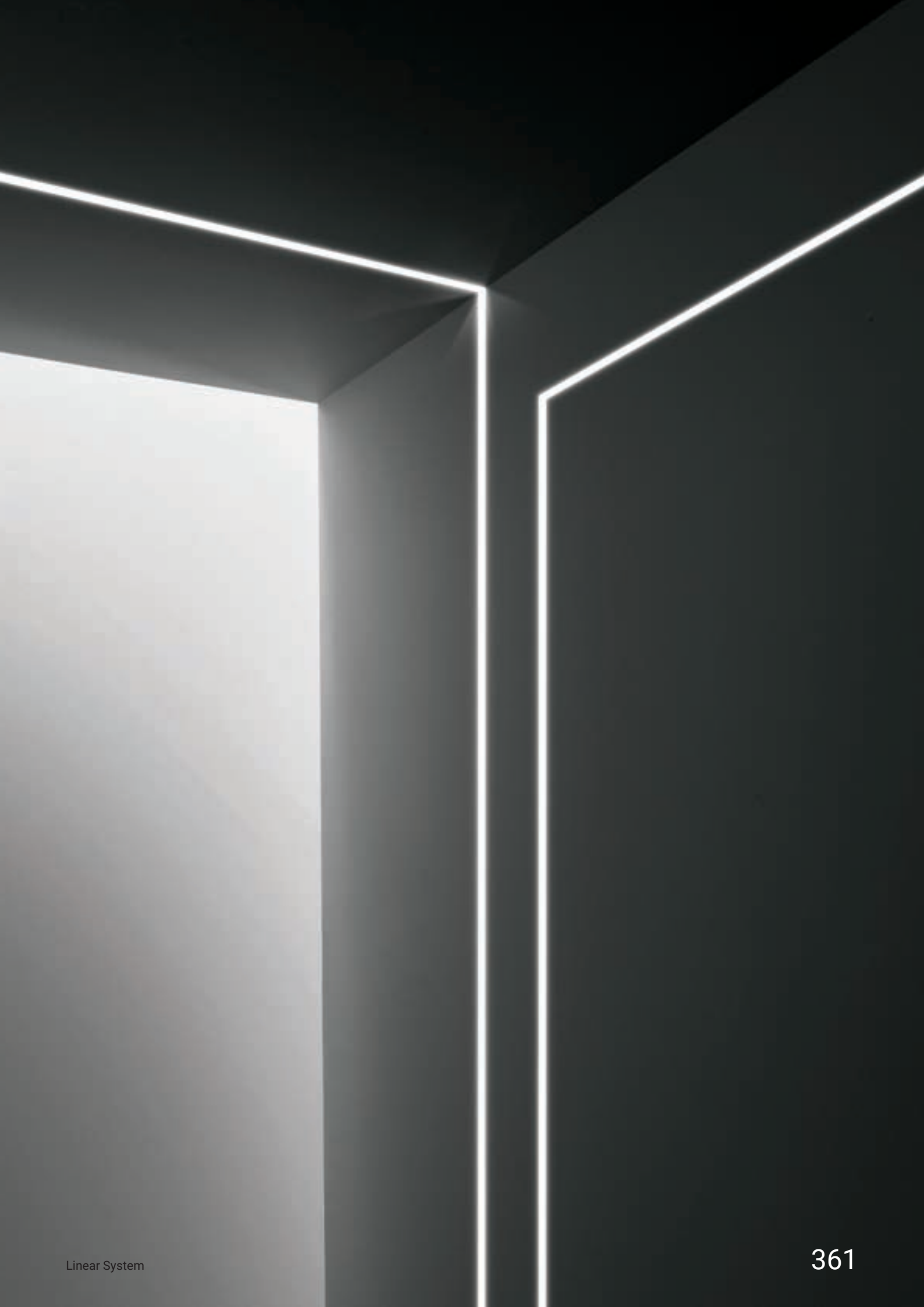

fylo+ range

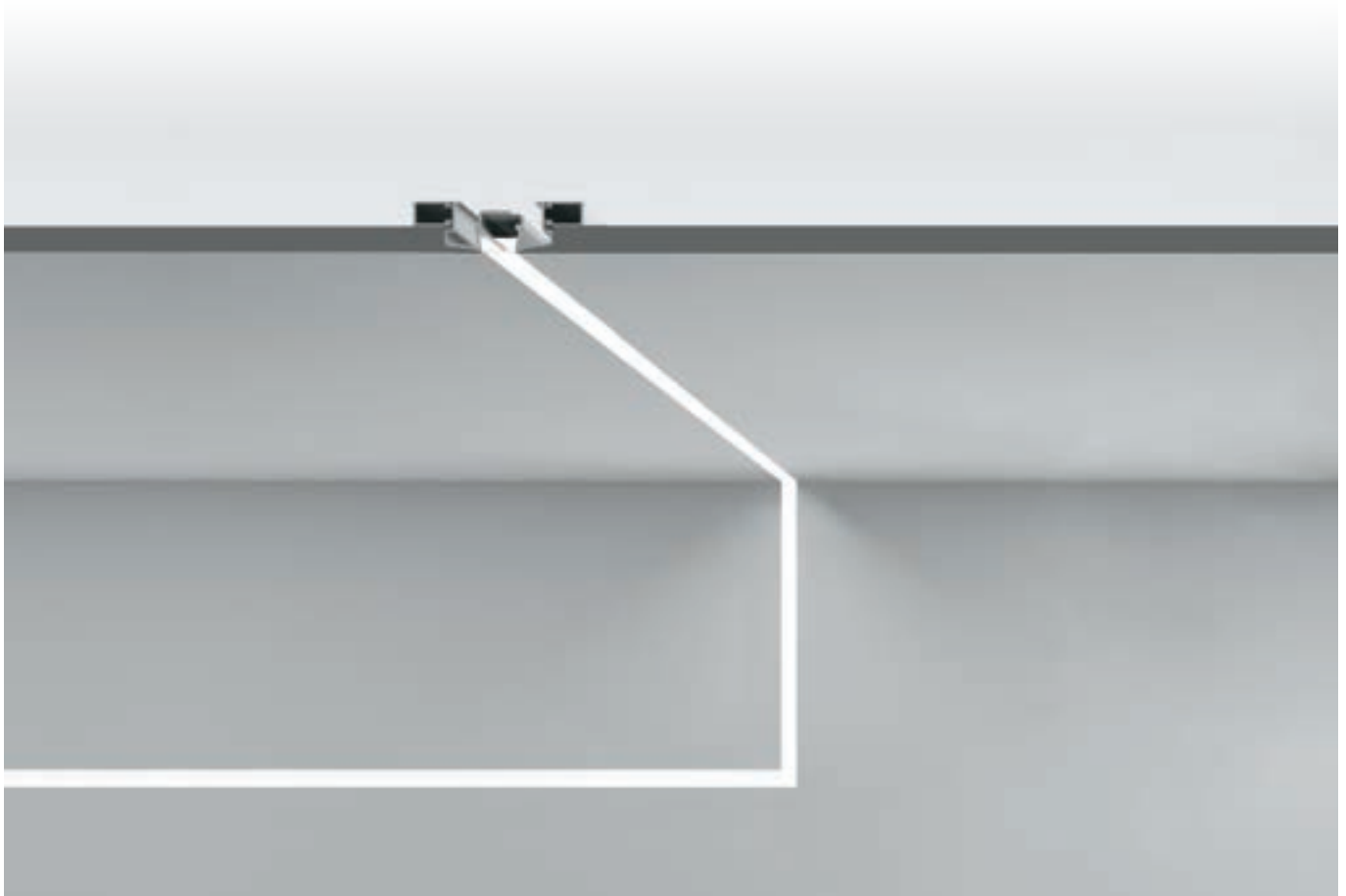

Direct

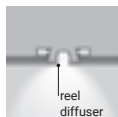

Recessed

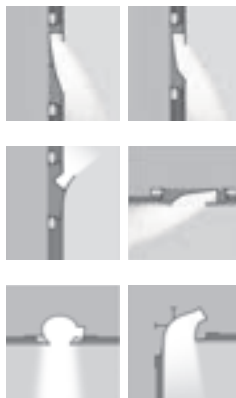

Surface

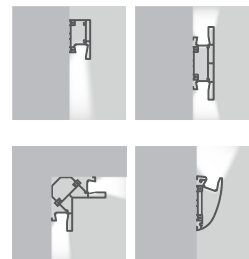

Lenght	1000 mm 2000 mm Custom 1100 - 1900 mm (min. 100 mm)	1000 mm 2000 mm Custom 1100 - 1900 mm (min. 100 mm)	1000 mm 2000 mm Custom 1100 - 1900 mm (min. 100 mm)
LED source	Inflex LED Strip	Inflex LED Strip	Inflex LED Strip
Control	On/Off DALI 0/1-10 V	On/Off DALI 0/1-10 V	On/Off DALI 0/1-10 V

Plus de lumière, plus d'efficacité.

Le choix de l'aluminium, allégé grâce à un design spécifique développé pour la section des profilés, permet d'utiliser la surface du module comme dissipateur, améliorant ainsi les performances lumineuses disponibles de la gamme.

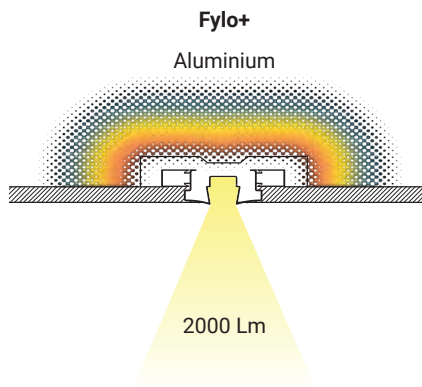

Ligne continue sans interruption

Le nouveau DIFFUSEUR À ROULEAU a été conçu pour créer des lignes lumineuses continues. Une fois fixée à l'extrémité, la bobine spéciale en polycarbonate se déroule sur toute la longueur du profilé : cette solution permet d'éviter des opérations d'installation complexes qui sont alors remplacées par une opération simple et unique de montage avec des temps considérablement réduits. Lorsque l'appareil est allumé, le diffuseur masque et uniformise la lumière émise par la source, réduisant ainsi considérablement l'éblouissement, même en cas d'observation directe.

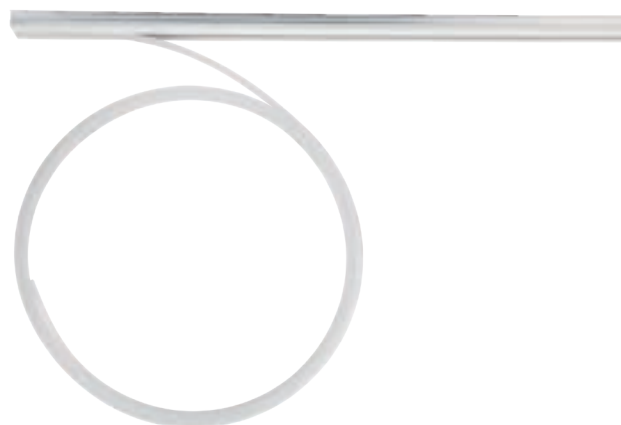

Installation rapide

L'installation des profilés s'effectue par encliquetage sur un support dédié. Des éléments spéciaux en plastique ont été introduits sur l'arrière des profilés, entre des guides linéaires servant à les faire coulisser. La fixation n'est pas liée à un point prédéfini mais peut s'effectuer selon les nécessités de l'installateur.

Fylo+ Surface

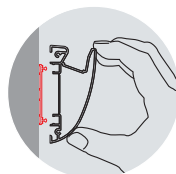

Rapprocher le profilé du support

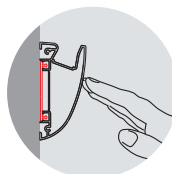

Poussez le produit fermement contre le support

Fylo+ Recessed

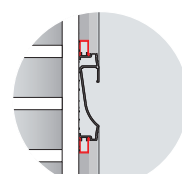
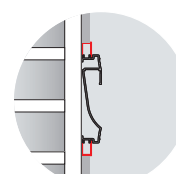

Fylo+ Recessed est conçu pour être installé dans les murs en plaques de plâtre. Pour l'installation sur des murs existants, il suffit de retirer les ailes latérales incluses dans le profilé.

Procédure d'installation

Fylo+ conserve la même esthétique que les versions précédentes. Une fois installés, les profilés disparaissent en fusionnant entièrement avec l'architecture qui les entoure ; le concept de luminaire intégré permet de personnaliser les espaces avec des détails de lumière inédits et précieux.

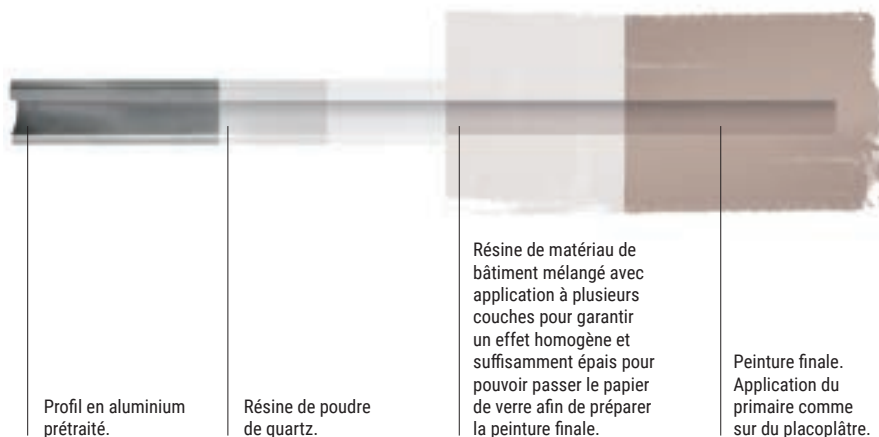

Fylo_Direct



65180 - 65181

Fylo_Recessed



65006 - 65007



65003 - 65004



65027 - 65028



65009 - 65010



65012 - 65013

Fylo_Surface



65015 - 65016



65018 - 65019



65021 - 65022



65024 - 65025

Fylo+ Direct_1 | Reel diffuser | Recessed linear light



57xL

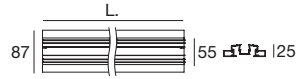

		L mm
White	65180	1000
White	65181	2000
White	65187*	custom

Accessoires Pag. 369

- 65184** Diffuseur opalin L rouleau 5 m
- 65183** Diffuseur opalin L rouleau 10 m
- 65182** Diffuseur opalin L rouleau 20 m
- 62900** Boîtier d'encastrement pour faux plafonds

Les modules doivent être complétés par une source de lumière et une alimentation.

*En sélectionnant le code « Custom », il est possible de commander la longueur de profilé souhaitée, d'un minimum de 1,1 m à un maximum de 1,9 m. Par exemple : pour obtenir 1,3 m de Fylo+, il suffit de commander 1,3 x 65187.

RTG 65180 / 65181

Fylo+ | Light units - LED Strips



type

- Ribbon **Pag. 900**
- Dropper **Pag. 908**

Électronique

99374	99331	99332	83062	99787
ON/OFF 75 W p 210 x l 48 x h 25	ON/OFF 150 W p 150 x l 60 x h 35	0/1-10V 150 W p 150 x l 60 x h 35	DALI 120 W p 191 x l 63 x h 38	DALI 120 W p 244 x l 71 x h 38

Fylo+ Recessed_1 | Recessed linear light body

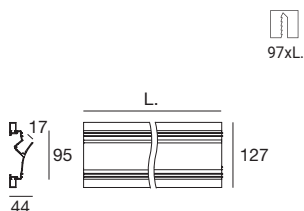

		L mm
White	65027	1000
White	65028	2000
White	65032*	custom

Accessoires Pag. 369

- 65054** Diffuseur opalin 1pcs L 1 m
- 65055** Diffuseur opalin 5pcs L 1 m
- 62900** Boîtier d'encastrement pour faux plafonds

Les modules doivent être complétés par une source de lumière et une alimentation.

*En sélectionnant le code « Custom », il est possible de commander la longueur de profilé souhaitée, d'un minimum de 1,1 m à un maximum de 1,9 m.
Par exemple : pour obtenir 1,3 m de Fylo+, il suffit de commander 1,3 x 65032.

Fylo+ Recessed_2 | Recessed linear light body

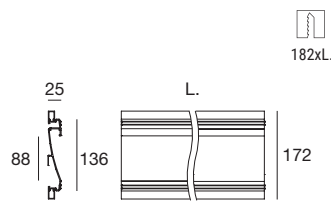

		L mm
White	65006	1000
White	65007	2000
White	65045*	custom

Accessoires Pag. 369

- 65054** Diffuseur opalin 1pcs L 1 m
- 65055** Diffuseur opalin 5pcs L 1 m
- 62900** Boîtier d'encastrement pour faux plafonds

Les modules doivent être complétés par une source de lumière et une alimentation.

*En sélectionnant le code « Custom », il est possible de commander la longueur de profilé souhaitée, d'un minimum de 1,1 m à un maximum de 1,9 m.
Par exemple : pour obtenir 1,3 m de Fylo+, il suffit de commander 1,3 x 65045.

Fylo+ Recessed_3 | Recessed linear light body

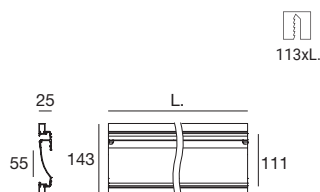

		L mm
White	65003	1000
White	65004	2000
White	65046*	custom

Accessoires Pag. 369

- 65054** Diffuseur opalin 1pcs L 1 m
- 65055** Diffuseur opalin 5pcs L 1 m
- 62900** Boîtier d'encastrement pour faux plafonds

Les modules doivent être complétés par une source de lumière et une alimentation.

*En sélectionnant le code « Custom », il est possible de commander la longueur de profilé souhaitée, d'un minimum de 1,1 m à un maximum de 1,9 m.
Par exemple : pour obtenir 1,3 m de Fylo+, il suffit de commander 1,3 x 65046.

RTG **65004**

Fylo+ Recessed_4 | Recessed linear light body

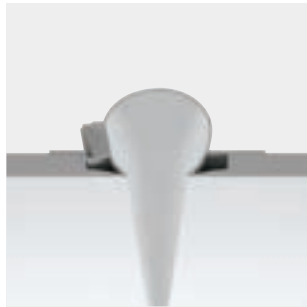

94xL.

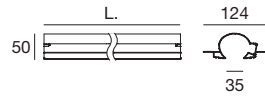

		L mm
White	65009	1000
White	65010	2000
White	65047*	custom

Accessoires Pag. 369

65054 Diffuseur opalin 1pcs L 1 m

65055 Diffuseur opalin 5pcs L 1 m

62900 Boîtier d'encastrement pour faux plafonds

Les modules doivent être complétés par une source de lumière et une alimentation.

*En sélectionnant le code « Custom », il est possible de commander la longueur de profilé souhaitée, d'un minimum de 1,1 m à un maximum de 1,9 m.

Par exemple : pour obtenir 1,3 m de Fylo+, il suffit de commander 1,3 x 65047.

RTG 65009 / 65010

Fylo+ Recessed_5 | Recessed linear light body

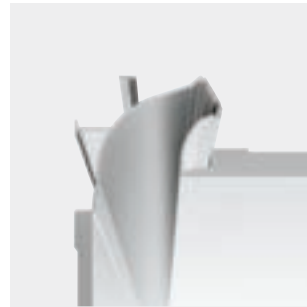

65xL.

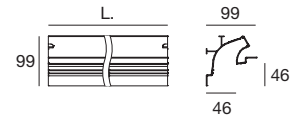

		L mm
White	65012	1000
White	65013	2000
White	65048*	custom

Accessoires Pag. 369

65054 Diffuseur opalin 1pcs L 1 m

65055 Diffuseur opalin 5pcs L 1 m

62900 Boîtier d'encastrement pour faux plafonds

Les modules doivent être complétés par une source de lumière et une alimentation.

*En sélectionnant le code « Custom », il est possible de commander la longueur de profilé souhaitée, d'un minimum de 1,1 m à un maximum de 1,9 m.

Par exemple : pour obtenir 1,3 m de Fylo+, il suffit de commander 1,3 x 65048.

Fylo+ Surface_1 | Surface light body

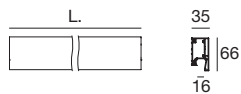

		L mm
White	65015	1000
White	65016	2000
White	65049*	custom

Accessoires Pag. 369

- 65054** Diffuseur opalin 1pcs L 1 m
- 65055** Diffuseur opalin 5pcs L 1 m
- 62900** Boîtier d'encastrement pour faux plafonds
- 65008** Bouchons de fermeture 2 pcs

Les modules doivent être complétés par une source de lumière et une alimentation.

*En sélectionnant le code « Custom », il est possible de commander la longueur de profilé souhaitée, d'un minimum de 1,1 m à un maximum de 1,9 m.
Par exemple : pour obtenir 1,3 m de Fylo+, il suffit de commander 1,3 x 65049.

RTG 65015 / 65016

Fylo+ Surface_3 | Surface light body

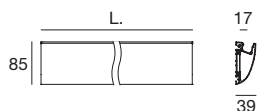

		L mm
White	65021	1000
White	65022	2000
White	65058*	custom

Accessoires Pag. 369

- 65054** Diffuseur opalin 1pcs L 1 m
- 65055** Diffuseur opalin 5pcs L 1 m
- 62900** Boîtier d'encastrement pour faux plafonds
- 65014** Bouchons de fermeture 2 pcs

Les modules doivent être complétés par une source de lumière et une alimentation.

*En sélectionnant le code « Custom », il est possible de commander la longueur de profilé souhaitée, d'un minimum de 1,1 m à un maximum de 1,9 m.
Par exemple : pour obtenir 1,3 m de Fylo+, il suffit de commander 1,3 x 65058.

Fylo+ Surface_2 | Surface light body

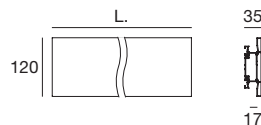
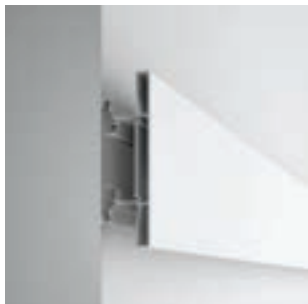

		L mm
White	65018	1000
White	65019	2000
White	65053*	custom

Accessoires Pag. 369

- 65054** Diffuseur opalin 1pcs L 1 m
- 65055** Diffuseur opalin 5pcs L 1 m
- 62900** Boîtier d'encastrement pour faux plafonds
- 65011** Bouchons de fermeture 2 pcs

Les modules doivent être complétés par une source de lumière et une alimentation.

*En sélectionnant le code « Custom », il est possible de commander la longueur de profilé souhaitée, d'un minimum de 1,1 m à un maximum de 1,9 m.
Par exemple : pour obtenir 1,3 m de Fylo+, il suffit de commander 1,3 x 65053.

RTG 65018 / 65019

Fylo+ Surface_4 | Angolare light body



		L mm
White	65024	1000
White	65025	2000
White	65059*	custom

Accessoires Pag. 369

- 65054** Diffuseur opalin 1pcs L 1 m
- 65055** Diffuseur opalin 5pcs L 1 m
- 62900** Boîtier d'encastrement pour faux plafonds
- 65097** Bouchons de fermeture 2 pcs

Les modules doivent être complétés par une source de lumière et une alimentation.

*En sélectionnant le code « Custom », il est possible de commander la longueur de profilé souhaitée, d'un minimum de 1,1 m à un maximum de 1,9 m.
Par exemple : pour obtenir 1,3 m de Fylo+, il suffit de commander 1,3 x 65059.

RTG 65025



type

Ribbon **Pag. 900**

Dropper **Pag. 908**

Électronique

99374	99331	99332	83062	99787
ON/OFF 75 W p 210 x l 48 x h 25	ON/OFF 150 W p 150 x l 60 x h 35	0/1-10V 150 W p 150 x l 60 x h 35	DALI 120 W p 191 x l 63 x h 38	DALI 120 W p 244 x l 71 x h 38

Section barre LED

Dans le cas d'une longueur totale inférieure à un multiple de 500 mm, il est possible de couper, avec une scie manuelle, la barre de LED afin d'obtenir des mesures multiples de 100 mm, en prenant soin de positionner la lame sur point indiqué sur la figure. Un sectionnement incorrect risque de compromettre le fonctionnement de la barre.

Accessoires



description
65184 Diffuseur opalin 5 m
suitable for: Fylo+ Direct_1 / Fylo+ Recessed_Y



description
65183 Diffuseur opalin 10 m
suitable for: Fylo+ Direct_1 / Fylo+ Recessed_Y



description
65182 Diffuseur opalin 20 m
suitable for: Fylo+ Direct_1 / Fylo+ Recessed_Y

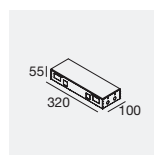

description
62900 Boîtier d'encastrement
suitable for: Fylo+ Direct_1 / Fylo+ Recessed_1
Fylo+ Recessed_2 / Fylo+ Recessed_3
Fylo+ Recessed_4 / Fylo+ Recessed_5
Fylo+ Recessed_Y / Fylo+ Surface_1 / Fylo+ Surface_2
Fylo+ Surface_3 / Fylo+ Surface_4

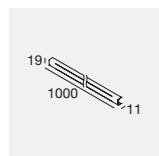

description
65054 Diffuseur opalin 1 m
suitable for: Fylo+ Recessed_1 / Fylo+ Recessed_2
Fylo+ Recessed_3 / Fylo+ Recessed_4
Fylo+ Recessed_5 / Fylo+ Surface_1 / Fylo+ Surface_2
Fylo+ Surface_3 / Fylo+ Surface_4

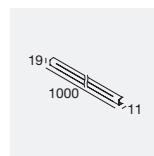

description
65055 Diffuseur opalin 1 m x 5pcs
suitable for: Fylo+ Recessed_1 / Fylo+ Recessed_2
Fylo+ Recessed_3 / Fylo+ Recessed_4
Fylo+ Recessed_5 / Fylo+ Surface_1 / Fylo+ Surface_2
Fylo+ Surface_3 / Fylo+ Surface_4

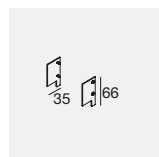

description
65008 Bouchons de fermeture
suitable for: Fylo+ Surface_1

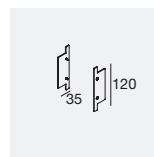

description
65011 Bouchons de fermeture
suitable for: Fylo+ Surface_2

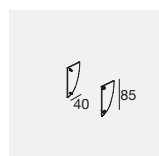

description
65014 Bouchons de fermeture
suitable for: Fylo+ Surface_3

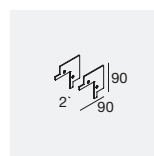

description
65097 Bouchons de fermeture
suitable for: Fylo+ Surface_4





archicove

Matériaux

Corps en aluminium

Diffuseur en polycarbonate opalin





Archicove | Linear profiles | 24 V DC | topLED



CRI 80 - 10W DC		Cct	lm S - D	Optic
Black	94110	M 2700	979 - 620	30 Flood (34°)
		W 3000	1044 - 662	60 W.Flood (60°)
		N 4000	1092 - 692	00 General (128°)
				07 Asymm. -

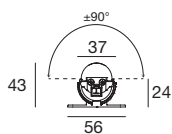
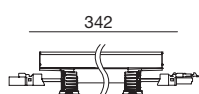

CRI 80 - 30W DC		Cct	lm S - D	Optic
Black	94115	M 2700	2925 - 1855	30 Flood (34°)
		W 3000	3132 - 1986	60 W.Flood (60°)
		N 4000	3276 - 2077	00 General (128°)
				07 Asymm. -

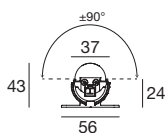
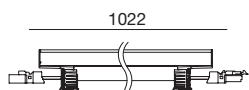

Électronique

99374	99331	99332	83062	99787
ON/OFF 75 W	ON/OFF 150 W	0/1-10V 150 W	DALI 120 W	DALI 120 W
p 210 x 148 x h 25	p 150 x 160 x h 35	p 150 x 160 x h 35	p 191 x 163 x h 38	p 244 x 171 x h 38

Accessoires et câbles Pag. 375



Luminaires équipés de connecteurs mâle et femelle, conçus pour installer rapidement une ligne continue.

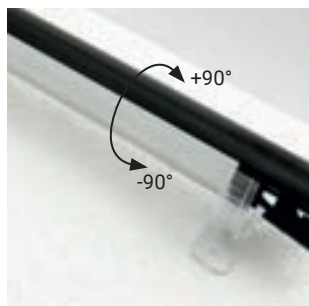

Possibilité d'ajuster le faisceau avec précision en jouant sur l'angle de rotation du profilé LED.

Archicove On/Off | Linear profiles | 190-240 V AC | topLED



CRI 80 - 9W DC - 10W AC		Cct	lm S - D	Optic
Black	92023	M 2700	979 - 620	30 Flood (34°)
		W 3000	1044 - 662	60 W.Flood (60°)
		N 4000	1092 - 690	00 General (128°)
				07 Asymm. -

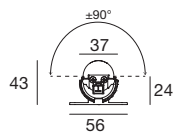

CRI 80 - 27W DC - 30W AC		Cct	lm S - D	Optic
Black	92025	M 2700	2925 - 1855	30 Flood (34°)
		W 3000	3132 - 1986	60 W.Flood (60°)
		N 4000	3276 - 2077	00 General (128°)
				07 Asymm. -

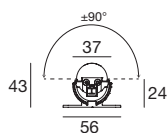
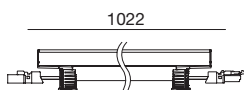

Accessoires et câbles Pag. 375

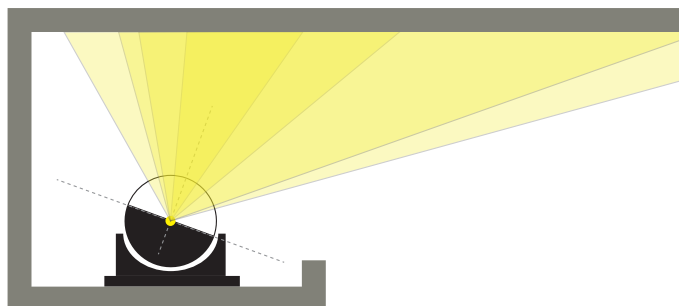

La grande variété d'optiques permet de choisir parmi une large gamme de solutions. Plus particulièrement, cette variété permet de réinterpréter le concept d'éclairage en niche: non seulement ce dernier se caractérise par une lumière indirecte, douce et diffuse, mais il constitue également un outil permettant de valoriser l'architecture avec des lignes plus ou moins étroites.

Accessoires



description

98699 Plaque de support

98781 Plaque de support

suitable for: Archicove / Archicove On/Off

Câbles



description

98879 Alimentation 24V

suitable for: Archicove



description

98878 Rallonge 24V

suitable for: Archicove

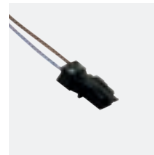

description

98713 Alimentation 190~250V

suitable for: Archicove On/Off



description

98716 Rallonge 190~250V

suitable for: Archicove On/Off

Kaplica | Hockberg, Poland

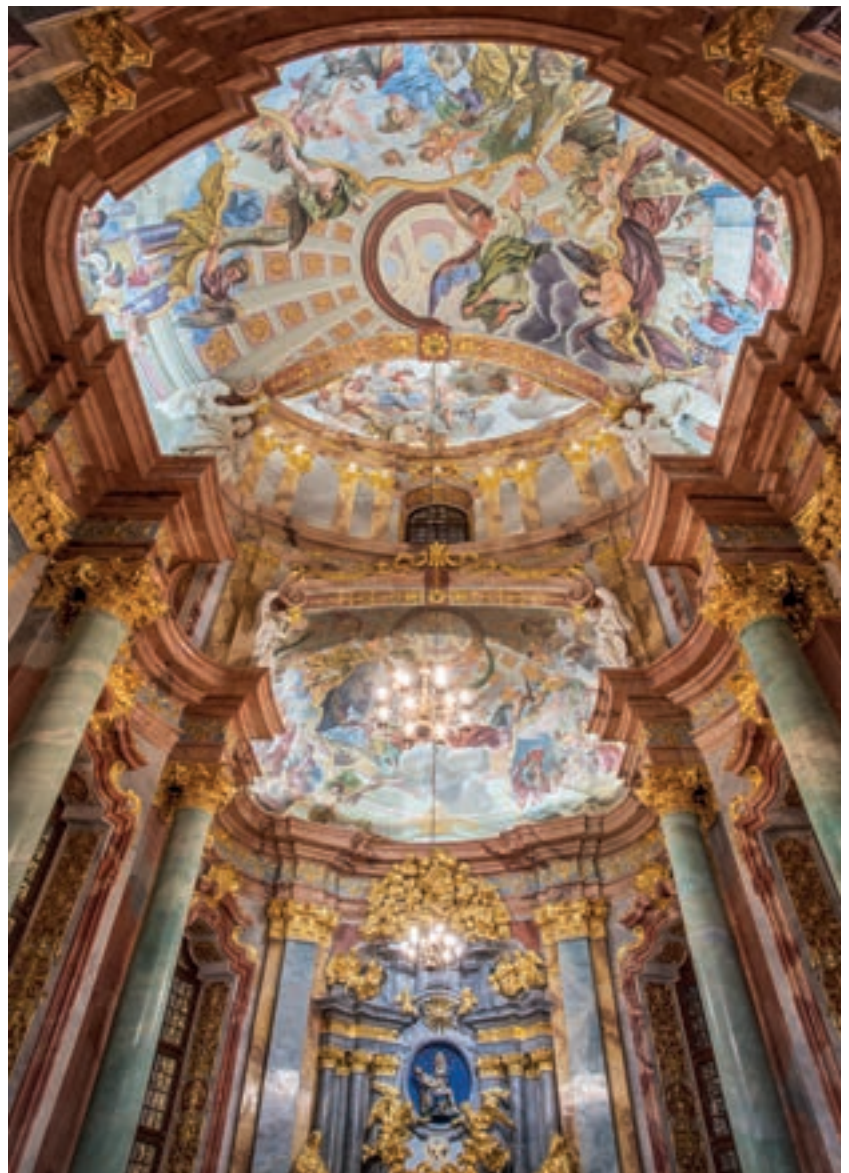



ice-cut

Matériaux

Corps en polycarbonate translucide



Ice-Cut | Linear profiles | 24 V DC | topLED

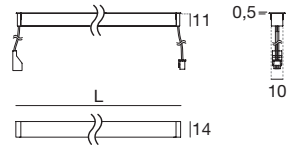

L 512 mm CRI 80 - 6W DC	Cct	lm S - D	Optic
Opaline 81247	M 2700	420 - 244	00 General (113°)
	W 3000	438 - 265	
	N 4000	478 - 289	



Électronique

99374	83018	99332	99722
ON/OFF 1 - 12 art. p 210 x 148 x h 25	PUSH 1 - 12 art. p 210 x 149 x h 30	0/1-10V 1 - 25 art. p 150 x 160 x h 35	DALI 1 - 20 art. p 191 x 163 x h 38

L 1012 mm CRI 80 - 12W DC	Cct	lm S - D	Optic
Opaline 81249	M 2700	840 - 488	00 General (113°)
	W 3000	875 - 530	
	N 4000	956 - 579	



Électronique

99374	83018	99332	99722
ON/OFF 1 - 6 art. p 210 x 148 x h 25	PUSH 1 - 6 art. p 210 x 149 x h 30	0/1-10V 1 - 12 art. p 150 x 160 x h 35	DALI 1 - 10 art. p 191 x 163 x h 38

L 1512 mm CRI 80 - 18W DC	Cct	lm S - D	Optic
Opaline 81251	M 2700	1260 - 731	00 General (149°)
	W 3000	1313 - 794	
	N 4000	1434 - 868	



Électronique

99374	83018	99332	99722
ON/OFF 1 - 4 art. p 210 x 148 x h 25	PUSH 1 - 8 art. p 210 x 149 x h 30	0/1-10V 1 - 8 art. p 150 x 160 x h 35	DALI 1 - 6 art. p 191 x 163 x h 38

L 2012 mm CRI 80 - 24W DC	Cct	lm S - D	Optic
Opaline 81253	M 2700	1680 - 975	00 General (149°)
	W 3000	1750 - 1060	
	N 4000	1912 - 1157	



Électronique

99374	83018	99332	99722
ON/OFF 1 - 3 art. p 210 x 148 x h 25	PUSH 1 - 3 art. p 210 x 149 x h 30	0/1-10V 1 - 6 art. p 150 x 160 x h 35	DALI 1 - 5 art. p 191 x 163 x h 38

Accessoires Pag. 379

Ice-Cut | Linear profiles | 24 V DC | topLED

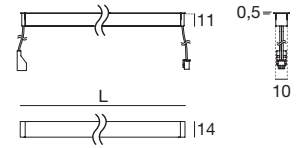

L 512 mm CRI 92 - 6W DC	Cct	lm S - D	Optic
Opaline 81248	W 3000	373 - 225	00 General (113°)
	N 4000	409 - 248	



Électronique

99374	83018	99332	99722
ON/OFF 1 - 12 art. p 210 x 148 x h 25	PUSH 1 - 12 art. p 210 x 149 x h 30	0/1-10V 1 - 25 art. p 150 x 160 x h 35	DALI 1 - 20 art. p 191 x 163 x h 38

L 1012 mm CRI 92 - 12W DC	Cct	lm S - D	Optic
Opaline 81250	W 3000	745 - 451	00 General (113°)
	N 4000	818 - 496	



Électronique

99374	83018	99332	99722
ON/OFF 1 - 6 art. p 210 x 148 x h 25	PUSH 1 - 6 art. p 210 x 149 x h 30	0/1-10V 1 - 12 art. p 150 x 160 x h 35	DALI 1 - 10 art. p 191 x 163 x h 38

L 1512 mm CRI 92 - 18W DC	Cct	lm S - D	Optic
Opaline 81252	W 3000	1118 - 676	00 General (149°)
	N 4000	1227 - 743	



Électronique

99374	83018	99332	99722
ON/OFF 1 - 4 art. p 210 x 148 x h 25	PUSH 1 - 8 art. p 210 x 149 x h 30	0/1-10V 1 - 8 art. p 150 x 160 x h 35	DALI 1 - 6 art. p 191 x 163 x h 38

L 2012 mm CRI 92 - 24W DC	Cct	lm S - D	Optic
Opaline 81254	W 3000	1490 - 903	00 General (149°)
	N 4000	1636 - 991	



Électronique

99374	83018	99332	99722
ON/OFF 1 - 3 art. p 210 x 148 x h 25	PUSH 1 - 3 art. p 210 x 149 x h 30	0/1-10V 1 - 6 art. p 150 x 160 x h 35	DALI 1 - 5 art. p 191 x 163 x h 38

Accessoires Pag. 379

Pag. 379

RTG 95437W00

Ice-Cut_F | Linear profiles | 24 V DC | topLED

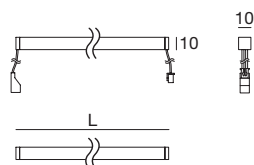

L 510 mm CRI 80 - 6W DC	Cct	lm S - D	Optic
Opaline 95436	M 2700	420 - 244	00 General (113°)
	W 3000	438 - 265	
	N 4000	478 - 289	

Électronique

99374	83018	99332	99722
ON/OFF 1 - 12 art. p 210 x 148 x h 25	PUSH 1 - 12 art. p 210 x 149 x h 30	0/1-10V 1 - 25 art. p 150 x 160 x h 35	DALI 1 - 20 art. p 191 x 163 x h 38

L 1010 mm CRI 80 - 12 W DC	Cct	lm S - D	Optic
Opaline 95437	M 2700	840 - 488	00 General (113°)
	W 3000	875 - 530	
	N 4000	956 - 579	

Électronique

99374	83018	99332	99722
ON/OFF 1 - 6 art. p 210 x 148 x h 25	PUSH 1 - 6 art. p 210 x 149 x h 30	0/1-10V 1 - 12 art. p 150 x 160 x h 35	DALI 1 - 10 art. p 191 x 163 x h 38

L 1510 mm CRI 80 - 18W DC	Cct	lm S - D	Optic
Opaline 95438	M 2700	1260 - 731	00 General (149°)
	W 3000	1313 - 794	
	N 4000	1434 - 868	

Électronique

99374	83018	99332	99722
ON/OFF 1 - 4 art. p 210 x 148 x h 25	PUSH 1 - 8 art. p 210 x 149 x h 30	0/1-10V 1 - 8 art. p 150 x 160 x h 35	DALI 1 - 6 art. p 191 x 163 x h 38

L 2010 mm CRI 80 - 24W DC	Cct	lm S - D	Optic
Opaline 95822	M 2700	1680 - 975	00 General (149°)
	W 3000	1750 - 1060	
	N 4000	1912 - 1157	

Électronique

99374	83018	99332	99722
ON/OFF 1 - 3 art. p 210 x 148 x h 25	PUSH 1 - 3 art. p 210 x 149 x h 30	0/1-10V 1 - 6 art. p 150 x 160 x h 35	DALI 1 - 5 art. p 191 x 163 x h 38

Accessoires Pag. 379

Ice-Cut_F | Linear profiles | 24 V DC | topLED

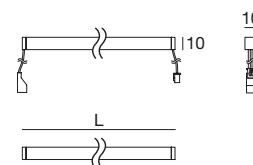

L 510 mm CRI 92 - 6 W DC	Cct	lm S - D	Optic
Opaline 97846	W 3000	373 - 225	00 General (113°)
	N 4000	409 - 248	

Électronique

99374	83018	99332	99722
ON/OFF 1 - 12 art. p 210 x 148 x h 25	PUSH 1 - 12 art. p 210 x 149 x h 30	0/1-10V 1 - 25 art. p 150 x 160 x h 35	DALI 1 - 20 art. p 191 x 163 x h 38

L 1010 mm CRI 92 - 12 W DC	Cct	lm S - D	Optic
Opaline 97847	W 3000	745 - 451	00 General (113°)
	N 4000	818 - 496	

Électronique

99374	83018	99332	99722
ON/OFF 1 - 6 art. p 210 x 148 x h 25	PUSH 1 - 6 art. p 210 x 149 x h 30	0/1-10V 1 - 12 art. p 150 x 160 x h 35	DALI 1 - 10 art. p 191 x 163 x h 38

L 1510 mm CRI 92 - 18W DC	Cct	lm S - D	Optic
Opaline 97848	W 3000	1118 - 676	00 General (149°)
	N 4000	1227 - 1078	

Électronique

99374	83018	99332	99722
ON/OFF 1 - 4 art. p 210 x 148 x h 25	PUSH 1 - 8 art. p 210 x 149 x h 30	0/1-10V 1 - 8 art. p 150 x 160 x h 35	DALI 1 - 6 art. p 191 x 163 x h 38

L 2010 mm CRI 92 - 24W DC	Cct	lm S - D	Optic
Opaline 97849	W 3000	1492 - 903	00 General (149°)
	N 4000	1636 - 991	

Électronique

99374	83018	99332	99722
ON/OFF 1 - 3 art. p 210 x 148 x h 25	PUSH 1 - 3 art. p 210 x 149 x h 30	0/1-10V 1 - 6 art. p 150 x 160 x h 35	DALI 1 - 5 art. p 191 x 163 x h 38

Accessoires Pag. 379

Accessoires



Câble à prises multiples

89121	Conn. F - 3 m
suitable for: Ice-Cut / Ice-Cut_F	



Rallonge pour prises multiples

89123	Conn. M + F - 1 m
89125	Conn. M + F - 3 m
suitable for: Ice-Cut / Ice-Cut_F	

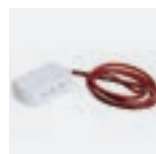

Câble à prises multiples

89119	Conn. 6 M - 1 m
suitable for: Ice-Cut / Ice-Cut_F	



Description

98398	Clips de fixation
suitable for: Ice-Cut_F	

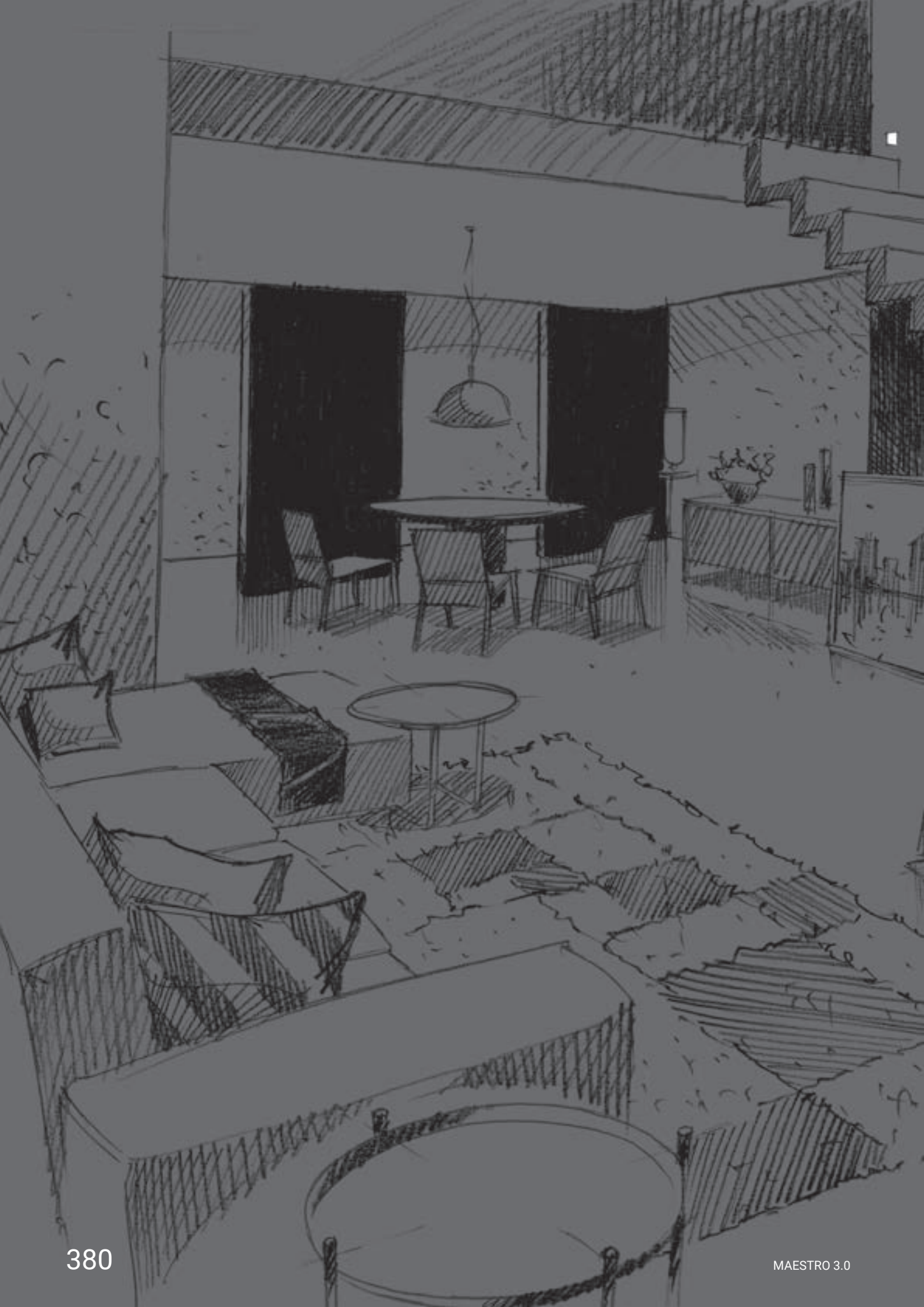

Path markers

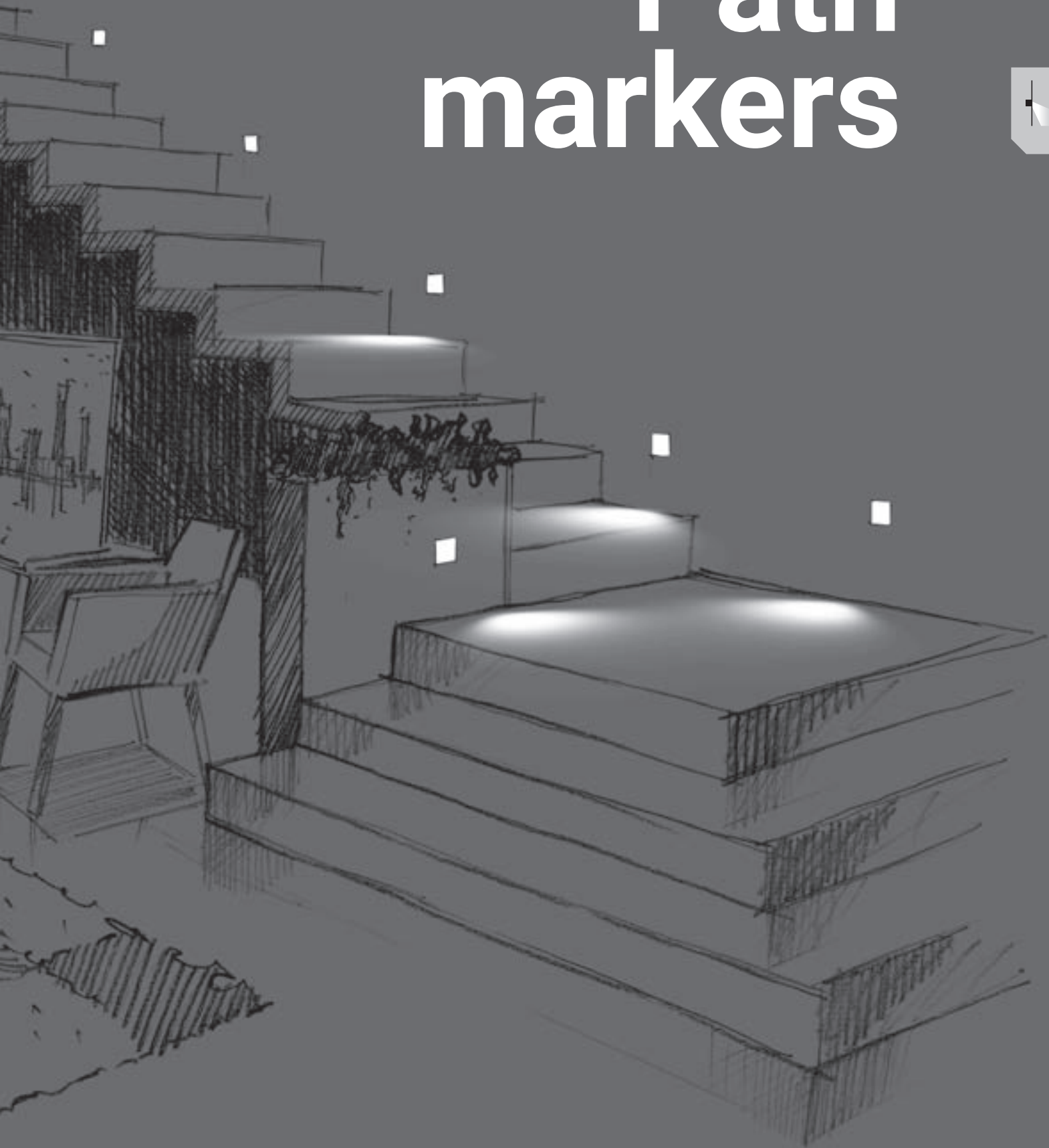

path markers range index

Step



Envelope

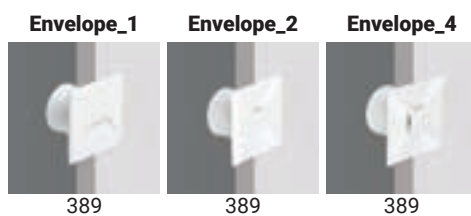

Petit

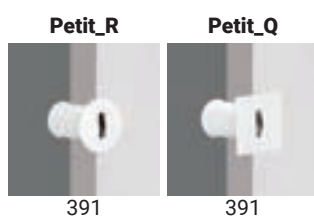

Quara

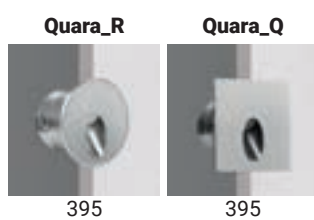

Dot

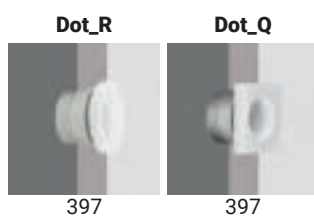

Vissa

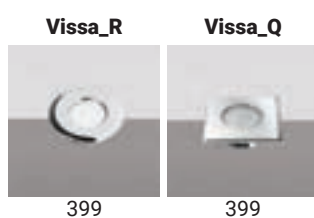

Ilamt









PARIS (13)



step

Matériaux
Corps en aluminium

Step | Path-marker | powerLED 1 W DC 350 mA

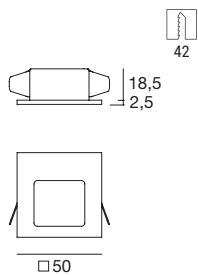

Efficiency - CRI 80	Cct	lm S - D	Optic
Chrome 81323	M 2700	136 - On req	07 Asymm. -
Nickel 81324	W 3000	145 - 68	
Brass 81325	N 4000	159 - 73	
White 81326			
Black 81327			

Électronique

89144	89145	99375	99708	99711	+ driver 24V DC
ON/OFF 1 - 2 art. p 138 x 122 x h 21	ON/OFF 3 - 6 art. p 138 x 122 x h 21	ON/OFF 6 - 12 art. p 138 x 122 x h 21	24V DC converter 0/1-10V 1 - 4 art. p 138 x 122 x h 21	24V DC converter DALI 1 - 4 art. p 138 x 122 x h 21	99374 75W 99331 150W

RTG 81323W07 / 81326W07

Boîtier d'encastrement Pag. 387

Boîtier d'encastrement

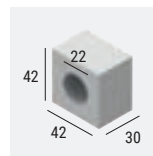

description

99850 Template

suitable for: Step



envelope

Matériaux
Corps en aluminium

Envelope_1 | Path-marker | powerLED 1 W DC 350 mA

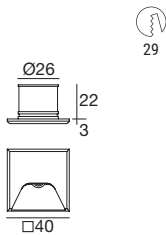

Efficiency - CRI 80	Cct	lm S - D	Optic
White 96976	M 2700	136 - 26	07 Asymm -
Grey 96978	W 3000	145 - 28	
DarkBrown 96979	N 4000	155 - 30	

Électronique

89144	89145	99375	99708	99711	+ driver 24V DC 99374 75W 99331 150W
ON/OFF 1 - 2 art. p 138 x l 22 x h 21	ON/OFF 3 - 6 art. p 138 x l 22 x h 21	ON/OFF 6 - 12 art. p 138 x l 22 x h 21	24V DC converter 0/1-10V 1 - 4 art. p 138 x l 22 x h 21	24V DC converter DALI 1 - 4 art. p 138 x l 22 x h 21	

Boîtier d'encastrement Pag. 389

Envelope_2 | Path-marker | powerLED 1 W DC 350 mA

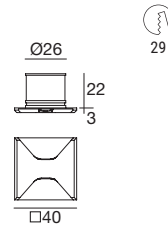

Efficiency - CRI 80	Cct	lm S - D	Optic
White 96971	M 2700	136 - On req	18 General (151°)
Grey 96973	W 3000	145 - 113	
DarkBrown 96974	N 4000	155 - 120	

Électronique

89144	89145	99375	99708	99711	+ driver 24V DC 99374 75W 99331 150W
ON/OFF 1 - 2 art. p 138 x l 22 x h 21	ON/OFF 3 - 6 art. p 138 x l 22 x h 21	ON/OFF 6 - 12 art. p 138 x l 22 x h 21	24V DC converter 0/1-10V 1 - 4 art. p 138 x l 22 x h 21	24V DC converter DALI 1 - 4 art. p 138 x l 22 x h 21	

Boîtier d'encastrement Pag. 389

Envelope_4 | Path-marker | powerLED 1 W DC 350 mA

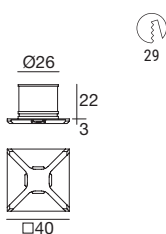

Efficiency - CRI 80	Cct	lm S - D	Optic
White 96966	M 2700	136 - On req	18 General (179°)
Grey 96968	W 3000	145 - 115	
DarkBrown 96969	N 4000	155 - 123	

Électronique

89144	89145	99375	99708	99711	+ driver 24V DC 99374 75W 99331 150W
ON/OFF 1 - 2 art. p 138 x l 22 x h 21	ON/OFF 3 - 6 art. p 138 x l 22 x h 21	ON/OFF 6 - 12 art. p 138 x l 22 x h 21	24V DC converter 0/1-10V 1 - 4 art. p 138 x l 22 x h 21	24V DC converter DALI 1 - 4 art. p 138 x l 22 x h 21	

Boîtier d'encastrement Pag. 389

Boîtier d'encastrement

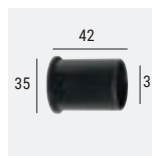

description	type
84336 Boîtier d'encastrement	PVC

suitable for: Envelope_1 / Envelope_2 / Envelope_4



petit

Matériaux

Corps en laiton ou aluminium

Petit_R | Path-marker | powerLED 1 W DC 350 mA



15

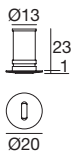

Efficiency - CRI 80		Cct	lm S - D	Optic
White	92316	M 2700	98 - On req	05 N.Spot (6°)
Nickel	92318	W 3000	107 - 98	
		N 4000	114 - 105	

Électronique

89144	89145	99375	99708	99711	+ driver 24V DC 99374 75W 99331 150W
ON/OFF 1 - 2 art. p 138 x l 22 x h 21	ON/OFF 3 - 6 art. p 138 x l 22 x h 21	ON/OFF 6 - 12 art. p 138 x l 22 x h 21	24V DC converter 0/1-10V 1 - 4 art. p 138 x l 22 x h 21	24V DC converter DALI 1 - 4 art. p 138 x l 22 x h 21	

Boîtier d'encastrement Pag. 393

RTG 92316W05

Petit_Q | Path-marker | powerLED 1 W DC 350 mA



15

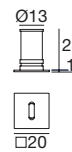

Efficiency - CRI 80		Cct	lm S - D	Optic
White	92324	M 2700	98 - On req	05 N.Spot (6°)
Nickel	92326	W 3000	107 - 98	
		N 4000	114 - 105	

Électronique

89144	89145	99375	99708	99711	+ driver 24V DC 99374 75W 99331 150W
ON/OFF 1 - 2 art. p 138 x l 22 x h 21	ON/OFF 3 - 6 art. p 138 x l 22 x h 21	ON/OFF 6 - 12 art. p 138 x l 22 x h 21	24V DC converter 0/1-10V 1 - 4 art. p 138 x l 22 x h 21	24V DC converter DALI 1 - 4 art. p 138 x l 22 x h 21	

Boîtier d'encastrement Pag. 393

RTG 92324W05

Petit_R | Path-marker | powerLED 1,5 W DC 500 mA



15

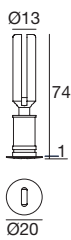

Efficiency - CRI 80		Cct	lm S - D	Optic
White	92320	M 2700	130 - On req	05 N.Spot (6°)
Nickel	92322	W 3000	143 - 131	
		N 4000	152 - 140	

Électronique

99195	89146	99377	99709	99712	+ driver 24V DC 99374 75W 99331 150W
ON/OFF 1 - 2 art. p 138 x l 22 x h 21	ON/OFF 2 - 3 art. p 138 x l 22 x h 21	ON/OFF 3 - 6 art. p 138 x l 22 x h 21	24V DC converter 0/1-10V 1 art. p 138 x l 22 x h 21	24V DC converter DALI 1 art. p 138 x l 22 x h 21	

Boîtier d'encastrement Pag. 393

Petit_Q | Path-marker | powerLED 1,5 W DC 500 mA



15

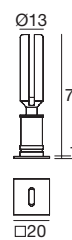

Efficiency - CRI 80		Cct	lm S - D	Optic
White	92328	M 2700	130 - On req	05 N.Spot (6°)
Nickel	92330	W 3000	143 - 131	
		N 4000	152 - 140	

Électronique

99195	89146	99377	99709	99712	+ driver 24V DC 99374 75W 99331 150W
ON/OFF 1 - 2 art. p 138 x l 22 x h 21	ON/OFF 2 - 3 art. p 138 x l 22 x h 21	ON/OFF 3 - 6 art. p 138 x l 22 x h 21	24V DC converter 0/1-10V 1 art. p 138 x l 22 x h 21	24V DC converter DALI 1 art. p 138 x l 22 x h 21	

Boîtier d'encastrement Pag. 393

Petit_R | Path-marker | powerLED 1 W DC 350 mA

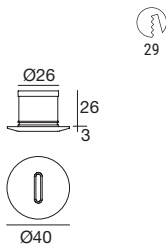

Efficiency - CRI 80		Cct	lm S - D	Optic
White	92405	M 2700	136 - On req	05 N.Spot (6°)
Nickel	92407	W 3000	145 - 119	
		N 4000	155 - 127	

Électronique

89144	89145	99375	99708	99711	+ driver 24V DC 99374 75W 99331 150W
ON/OFF 1 - 2 art. p 138 x l 22 x h 21	ON/OFF 3 - 6 art. p 138 x l 22 x h 21	ON/OFF 6 - 12 art. p 138 x l 22 x h 21	24V DC converter 0/1-10V 1 - 4 art. p 138 x l 22 x h 21	24V DC converter DALI 1 - 4 art. p 138 x l 22 x h 21	

Boîtier d'encastrement Pag. 393

RTG 92405W05

Petit_R | Path-marker | powerLED 2 W DC 630 mA

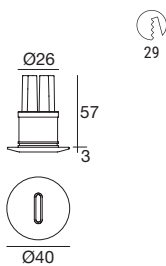

Efficiency - CRI 80		Cct	lm S - D	Optic
White	92409	M 2700	219 - On req	05 N.Spot (6°)
Nickel	92411	W 3000	233 - 191	
		N 4000	249 - 204	

Électronique

89147	99376	99105	99710	99713	+ driver 24V DC 99374 75W 99331 150W
ON/OFF 1 - 2 art. p 138 x l 22 x h 21	ON/OFF 3 - 6 art. p 138 x l 22 x h 21	ON/OFF 6 - 12 art. p 103 x l 58 x h 27	24V DC converter 0/1-10V 1 art. p 138 x l 22 x h 21	24V DC converter DALI 1 art. p 138 x l 22 x h 21	

Boîtier d'encastrement Pag. 393

RTG 92409W05

Petit_Q | Path-marker | powerLED 1 W DC 350 mA

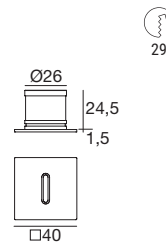

Efficiency - CRI 80		Cct	lm S - D	Optic
White	92413	M 2700	136 - On req	05 N.Spot (6°)
Nickel	92415	W 3000	145 - 119	
		N 4000	155 - 127	

Électronique

89144	89145	99375	99708	99711	+ driver 24V DC 99374 75W 99331 150W
ON/OFF 1 - 2 art. p 138 x l 22 x h 21	ON/OFF 3 - 6 art. p 138 x l 22 x h 21	ON/OFF 6 - 12 art. p 138 x l 22 x h 21	24V DC converter 0/1-10V 1 - 4 art. p 138 x l 22 x h 21	24V DC converter DALI 1 - 4 art. p 138 x l 22 x h 21	

Boîtier d'encastrement Pag. 393

RTG 92413W05

Petit_Q | Path-marker | powerLED 2 W DC 630 mA

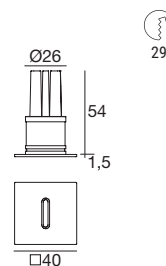

Efficiency - CRI 80		Cct	lm S - D	Optic
White	92417	M 2700	219 - On req	05 N.Spot 6°
Nickel	92419	W 3000	233 - 191	
		N 4000	249 - 204	

Électronique

89147	99376	99105	99710	99713	+ driver 24V DC 99374 75W 99331 150W
ON/OFF 1 - 2 art. p 138 x l 22 x h 21	ON/OFF 3 - 6 art. p 138 x l 22 x h 21	ON/OFF 6 - 12 art. p 103 x l 58 x h 27	24V DC converter 0/1-10V 1 art. p 138 x l 22 x h 21	24V DC converter DALI 1 art. p 138 x l 22 x h 21	

Boîtier d'encastrement Pag. 393

RTG 92417W05

Boîtier d'encastement

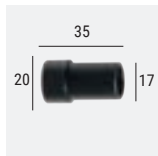

	description	type
84335	Boîtier d'encastement	PVC
suitable for: Petit_R 1W 20 mm / Petit_Q 1W 20 mm		

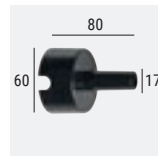

	description	type
84917	Boîtier d'encastement	PVC
suitable for: Petit_R 1,5W / Petit_Q 1,5W		

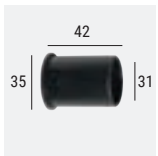

	description	type
84336	Boîtier d'encastement	PVC
suitable for: Petit_R 1W 40mm / Petit_Q 1W 40mm		

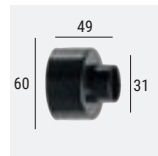

	description	type
84915	Boîtier d'encastement	PVC
suitable for: Petit_R 1W 40mm / Petit_Q 1W 40mm		

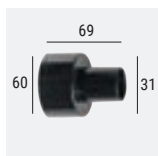

	description	type
84901	Boîtier d'encastement	PVC
suitable for: Petit_R 2W / Petit_Q 2W		





quara

Matériaux
Corps en aluminium

Quara_R | Path-marker | powerLED 1 W DC 350 mA



20

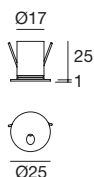

Efficiency - CRI 80	Cct	lm S - D	Optic
White 93508	M 2700	100 - 7	07 Asym. -
Grey 93513	W 3000	107 - 8	
DarkBrown 93515	N 4000	114 - 8	
Steel 93516			

Électronique

89144	89145	99375	99708	99711	+ driver 24V DC 99374 75W 99331 150W
ON/OFF 1 - 2 art. p 138 x l 22 x h 21	ON/OFF 3 - 6 art. p 138 x l 22 x h 21	ON/OFF 6 - 12 art. p 138 x l 22 x h 21	24V DC converter 0/1-10V 1 - 4 art. p 138 x l 22 x h 21	24V DC converter DALI 1 - 4 art. p 138 x l 22 x h 21	

RTG 93508W07 / 93513W07 / 93515W07

Quara_R | Path-marker | powerLED 2 W DC 630 mA



52

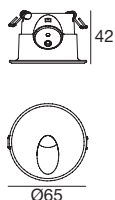

Efficiency - CRI 80	Cct	lm S - D	Optic
Nickel 86402	M 2700	219 - On req	70 W.Flood -
	W 3000	233 - 167	
	N 4000	249 - 178	

Électronique

89147	99376	99105	99710	99713	+ driver 24V DC 99374 75W 99331 150W
ON/OFF 1 - 2 art. p 138 x l 22 x h 21	ON/OFF 3 - 6 art. p 138 x l 22 x h 21	ON/OFF 6 - 12 art. p 103 x l 58 x h 27	24V DC converter 0/1-10V 1 art. p 138 x l 22 x h 21	24V DC converter DALI 1 art. p 138 x l 22 x h 21	



Efficiency - CRI 80	Cct	lm S - D	Optic
Nickel 83582	M 2700	219 - On req	70 W.Flood -
	W 3000	233 - 167	
	N 4000	249 - 178	

RTG 86402W70 / 86402N70

Quara_Q | Path-marker | powerLED 1 W DC 350 mA



20

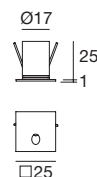

Efficiency - CRI 80	Cct	lm S - D	Optic
White 93517	M 2700	100 - 7	07 Asym. -
Grey 93518	W 3000	107 - 8	
DarkBrown 93519	N 4000	114 - 8	
Steel 93520			

Électronique

89144	89145	99375	99708	99711	+ driver 24V DC 99374 75W 99331 150W
ON/OFF 1 - 2 art. p 138 x l 22 x h 21	ON/OFF 3 - 6 art. p 138 x l 22 x h 21	ON/OFF 6 - 12 art. p 138 x l 22 x h 21	24V DC converter 0/1-10V 1 - 4 art. p 138 x l 22 x h 21	24V DC converter DALI 1 - 4 art. p 138 x l 22 x h 21	

RTG 93517W07 / 93518W07 / 93519W07

Quara_Q | Path-marker | powerLED 2 W DC 630 mA



52

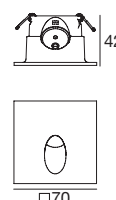

Efficiency - CRI 80	Cct	lm S - D	Optic
Nickel 86564	M 2700	219 - On req	70 W.Flood -
	W 3000	233 - 167	
	N 4000	249 - 178	

Électronique

89147	99376	99105	99710	99713	+ driver 24V DC 99374 75W 99331 150W
ON/OFF 1 - 2 art. p 138 x l 22 x h 21	ON/OFF 3 - 6 art. p 138 x l 22 x h 21	ON/OFF 6 - 12 art. p 103 x l 58 x h 27	24V DC converter 0/1-10V 1 art. p 138 x l 22 x h 21	24V DC converter DALI 1 art. p 138 x l 22 x h 21	



Efficiency - CRI 80	Cct	lm S - D	Optic
Nickel 83586	M 2700	219 - On req	70 W.Flood -
	W 3000	233 - 167	
	N 4000	249 - 178	

RTG 86564W70 / 86564N70

Boîtier d'encastrement



description	type
98950 Boîtier d'encastrement	PVC
suitable for: Quara_R 1W/ Quara_Q 1W	

31

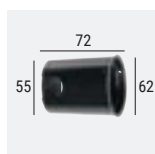

description	type
84338 Boîtier d'encastrement	PVC
suitable for: Quara_R 2W / Quara_Q 2W	

55

72

62

dot

Matériaux

Corps en aluminium anodisé

Diffuseur en polycarbonate opalin



Dot_R | Path-marker | powerLED 1 W DC 350 mA



25



Efficiency - CRI 80	Cct	lm S - D	Optic
Opaline 93521	M 2700	136 - 53	00 General (79°)
	W 3000	145 - 56	
	N 4000	155 - 60	

Électronique

89144	89145	99375	99708	99711	+ driver 24V DC 99374 75W 99331 150W
ON/OFF 1 - 2 art. p 138 x l 22 x h 21	ON/OFF 3 - 6 art. p 138 x l 22 x h 21	ON/OFF 6 - 12 art. p 138 x l 22 x h 21	24V DC converter 0/1-10V 1 - 4 art. p 138 x l 22 x h 21	24V DC converter DALI 1 - 4 art. p 138 x l 22 x h 21	

Boîtier d'encastrement Pag. 397

Dot_Q | Path-marker | powerLED 1 W DC 350 mA



25



Efficiency - CRI 80	Cct	lm S - D	Optic
Opaline 93522	M 2700	136 - 53	00 General (79°)
	W 3000	145 - 56	
	N 4000	155 - 60	

Électronique

89144	89145	99375	99708	99711	+ driver 24V DC 99374 75W 99331 150W
ON/OFF 1 - 2 art. p 138 x l 22 x h 21	ON/OFF 3 - 6 art. p 138 x l 22 x h 21	ON/OFF 6 - 12 art. p 138 x l 22 x h 21	24V DC converter 0/1-10V 1 - 4 art. p 138 x l 22 x h 21	24V DC converter DALI 1 - 4 art. p 138 x l 22 x h 21	

Boîtier d'encastrement Pag. 397

Boîtier d'encastrement



description	type
98992 Boîtier d'encastrement	PVC

suitable for: Dot_R 1W / Dot_Q 1W



vissa

Matériaux
Corps en laiton

Vissa_R | Path-marker | powerLED 0,7 W DC 220 mA



7,5|6|



Efficiency - CRI 80	Cct	lm S - D	Optic
Chrome 86717	M 2700	60 - 46	00 General (91°)
Nickel 86718	W 3000	66 - 51	
	C 5000	75 - 58	

Électronique

99307	83007	99198	99249	99151
ON/OFF 1 - 2 art. p 138 x 122 x h 21	ON/OFF 3 - 6 art. p 138 x 122 x h 21	ON/OFF 6 - 12 art. p 149 x 137 x h 30	0/1-10V 1 - 15 art. p 210 x 148 x h 25	DALI 1 - 15 art. p 210 x 148 x h 25

Accessoires Pag. 399

RTG 86717W00 / 86718W00



Vissa_Q | Path-marker | powerLED 0,7 W DC 220 mA



7,5|6|

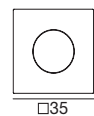

Efficiency - CRI 80	Cct	lm S - D	Optic
Chrome 86719	M 2700	60 - 46	00 General (91°)
Nickel 86720	W 3000	66 - 56	
	C 5000	75 - 63	

Électronique

99307	83007	99198	99249	99151
ON/OFF 1 - 2 art. p 138 x 122 x h 21	ON/OFF 3 - 6 art. p 138 x 122 x h 21	ON/OFF 6 - 12 art. p 149 x 137 x h 30	0/1-10V 1 - 15 art. p 210 x 148 x h 25	DALI 1 - 15 art. p 210 x 148 x h 25

Accessoires Pag. 399

RTG 86720W00

Accessoires



description	type
84952 Laveuse pour l'installation sur parquet	

suitable for: Vissa_R / Vissa_Q



ilamt

Matériaux
Corps en laiton

Ilamt | Wall light | powerLED 1 W DC 350 mA

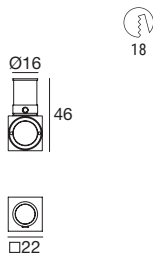

Efficiency - CRI 80	Cct	lm S - D	Optic
White 93986	M 2700	136 - On req	15 Spot (19°)
Nickel 93988	W 3000	145 - 111	30 Flood (25°)
	N 4000	155 - 118	60 W.Flood (50°)

Électronique

89144	89145	99375	99708	99711	+ driver 24V DC 99374 75W 99331 150W
ON/OFF 1 - 2 art. p 138 x l 22 x h 21	ON/OFF 3 - 6 art. p 138 x l 22 x h 21	ON/OFF 6 - 12 art. p 138 x l 22 x h 21	24V DC converter 0/1-10V 1 - 4 art. p 138 x l 22 x h 21	24V DC converter DALI 1 - 4 art. p 138 x l 22 x h 21	

Boîtier d'encastrement Pag. 401

Ilamt | Wall light | powerLED 2 W DC 630 mA

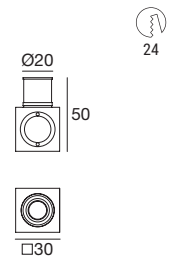

Efficiency - CRI 80	Cct	lm S - D	Optic
White 93566	M 2700	219 - On req	10 Spot (23°)
Nickel 86679	W 3000	233 - 116	30 Flood (45°)
	N 4000	249 - 140	50 W.Flood (69°)

Électronique

89147	99376	99105	99710	99713	+ driver 24V DC 99374 75W 99331 150W
ON/OFF 1 - 2 art. p 138 x l 22 x h 21	ON/OFF 3 - 6 art. p 138 x l 22 x h 21	ON/OFF 6 - 12 art. p 103 x l 58 x h 27	24V DC converter 0/1-10V 1 art. p 138 x l 22 x h 21	24V DC converter DALI 1 art. p 138 x l 22 x h 21	

Boîtier d'encastrement Pag. 401

Ilamt66 | Wall light | powerLED 2 W DC 630 mA

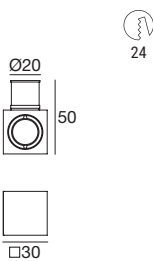

Efficiency - CRI 80	Cct	lm S - D	Optic
White 97086	M 2700	219 - On req	08 N.Spot (9°)
Nickel 97088	W 3000	233 - 200	15 Flood (34°)
	N 4000	249 - 214	30 Flood (45°)
			60 W.Flood (69°)

Électronique

89147	99376	99105	99710	99713	+ driver 24V DC 99374 75W 99331 150W
ON/OFF 1 - 2 art. p 138 x l 22 x h 21	ON/OFF 3 - 6 art. p 138 x l 22 x h 21	ON/OFF 6 - 12 art. p 103 x l 58 x h 27	24V DC converter 0/1-10V 1 art. p 138 x l 22 x h 21	24V DC converter DALI 1 art. p 138 x l 22 x h 21	

Boîtier d'encastrement Pag. 401

Boîtier d'encastrement

	description	type
	84337 Boîtier d'encastrement	PVC
suitable for: Ilmat 1W		
	description	type
	84349 Boîtier d'encastrement	PVC
suitable for: Ilmat 2W / Ilmat66 2W		

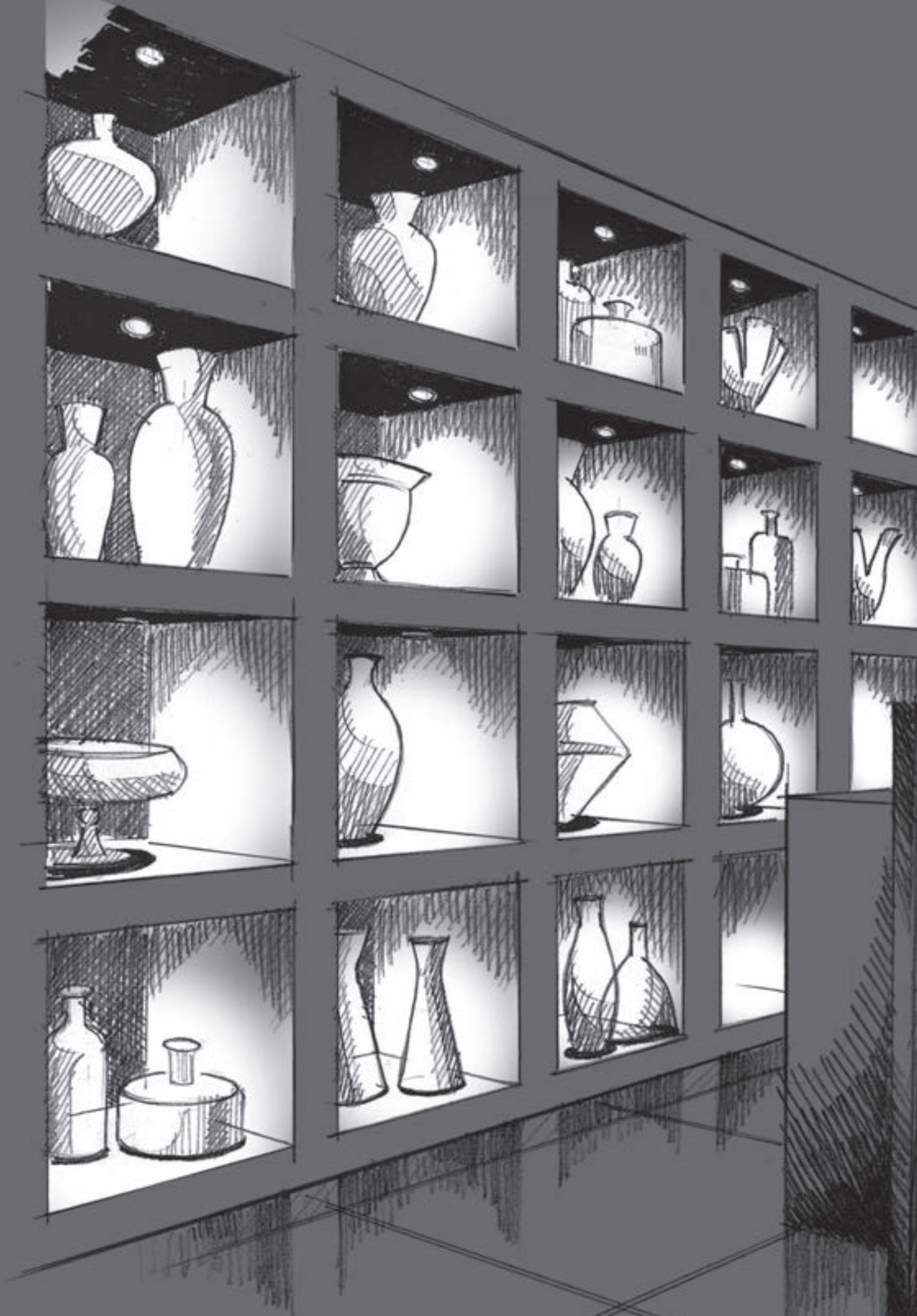

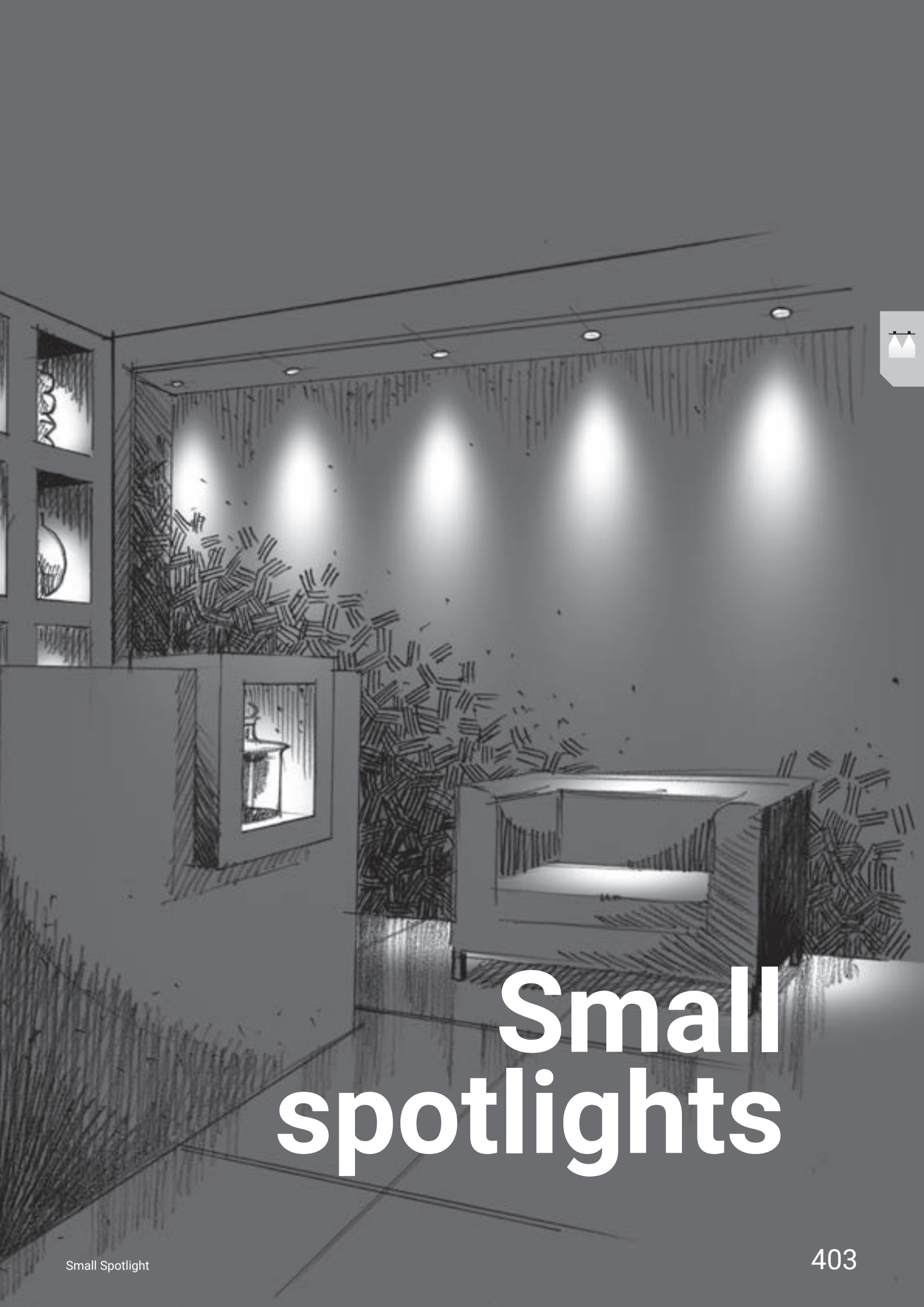

Small spotlights

small spotlights range index

Bibok

Bibok



409

Aspho

Aspho_R



412

Aspho_Q



414

Nitum

Nitum_R



417

Nitum_Q



418

Picrol

Picrol



421

Ghilea

Ghilea



423

Crystals

Beriel



426

Elin



430

Ture



431

Gude



432

Calypto

Calypto



435









bibok

Matériaux
Corps en laiton

Bibok | Decorative spotlight | 24 V DC | 5mmLED 0,5 W DC

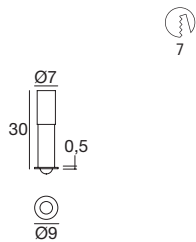

	Cct	Im S - D	Optic
White 91366	W 3000	42 - On req.	30 Flood (45°)
Chrome 85335	C 5000	58 - On req.	

Électronique

89408	99374	83018	99332	99722
ON/OFF 1 - 10 art. p 138 x l 22 x h 21	ON/OFF 1 - 140 art. p 210 x l 48 x h 25	PUSH 1 - 140 art. p 210 x l 48 x h 25	0/1-10V 1 - 280 art. p 150 x l 160 x h 35	ON/OFF 1 - 220 art. p 191 x l 163 x h 38

Boîtier d'encastrement Pag. 409

RTG 91366W30 / 91366C30 / 85335W30 / 85335C30

Bibok | Decorative spotlight | powerLED 1,5 W DC 500 mA

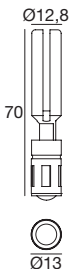

	Cct	Im S - D	Optic
White 91349	W 3000	143 - 122	70 Flood (45°)
Chrome 85979	N 4000	152 - 130	
	C 5000	185 - 158	

Électronique

99195	89146	99377	99709	99712	+ driver 24V DC 99374 75W 99331 150W
ON/OFF 1 - 2 art. p 138 x l 22 x h 21	ON/OFF 2 - 3 art. p 138 x l 22 x h 21	ON/OFF 3 - 6 art. p 138 x l 22 x h 21	24V DC converter 0/1-10V 1 art. p 138 x l 22 x h 21	24V DC converter DALI 1 art. p 138 x l 22 x h 21	

Boîtier d'encastrement Pag. 409

Bibok | Decorative spotlight | powerLED 1 W DC 350 mA



	Cct	Im S - D	Optic
White 91348	W 3000	107 - 91	70 Flood (45°)
Chrome 85976	N 4000	114 - 97	
	C 5000	139 - 119	

	Cct	Im S - D	Optic
White 91350	W 3000	107 - 96	12 W.Flood (53°)
Chrome 85575	N 4000	114 - 102	
	C 5000	139 - 125	

Électronique

89144	89145	99375	99708	99711	+ driver 24V DC 99374 75W 99331 150W
ON/OFF 1 - 2 art. p 138 x l 22 x h 21	ON/OFF 3 - 6 art. p 138 x l 22 x h 21	ON/OFF 6 - 12 art. p 138 x l 22 x h 21	24V DC converter 0/1-10V 1 - 4 art. p 138 x l 22 x h 21	24V DC converter DALI 1 - 4 art. p 138 x l 22 x h 21	

Boîtier d'encastrement Pag. 409

RTG 85575W12 / 91348W70 / 85976W70

Boîtier d'encastrement



description	type
84916 Boîtier d'encastrement	PVC

suitable for: Bibok 1W



description	type
84917 Boîtier d'encastrement	PVC

suitable for: Bibok 1,5W



aspho

Matériaux
Corps en laiton ou en acier



Aspho_R | Decorative spotlight | 24 V DC | 5mmLED 0,5 W DC



15

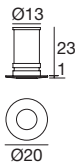

	Cct	lm S - D	Optic
White 88417	W 3000	45 - On req.	30 Flood (45°)
Chrome 85001	C 5000	58 - On req.	
Nickel 85002			

Électronique

89408	99374	83018	99332	99722
ON/OFF 1 - 10 art. p 138 x l 22 x h 21	ON/OFF 1 - 140 art. p 210 x l 48 x h 25	PUSH 1 - 140 art. p 210 x l 48 x h 25	0/1-10V 1 - 280 art. p 150 x l 60 x h 35	ON/OFF 1 - 220 art. p 191 x l 63 x h 38

Boîtier d'encastrement Pag. 414

RTG 88417W30 / 88417C30 / 85001W30 / 85001C30 / 85002W30

Aspho_R | Decorative spotlight | powerLED 1,5 W DC 500 mA



15

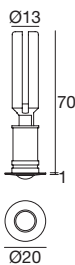

	Cct	lm S - D	Optic
White 91344	M 2700	130 - On req.	70 Flood (42°)
Chrome 85959	W 3000	143 - 122	
Nickel 85960	N 4000	152 - 130	
	C 5000	185 - 158	

	Cct	lm S - D	Optic
White 91346	M 2700	130 - On req.	12 W.Flood (50°)
Chrome 85947	W 3000	143 - 128	
Nickel 85948	N 4000	152 - 136	
	C 5000	185 - 166	

Électronique

99195	89146	99377	99709	99712	+ driver 24V DC 99374 75W 99331 150W
ON/OFF 1 - 2 art. p 138 x l 22 x h 21	ON/OFF 2 - 3 art. p 138 x l 22 x h 21	ON/OFF 3 - 6 art. p 138 x l 22 x h 21	24V DC converter 0/1-10V 1 art. p 138 x l 22 x h 21	24V DC converter DALI 1 art. p 138 x l 22 x h 21	

Boîtier d'encastrement Pag. 414

RTG 91344W70 / 85959W70 / 85960W70

Aspho_R | Decorative spotlight | powerLED 1 W DC 350 mA



15

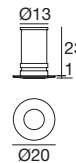

	Cct	lm S - D	Optic
White 91340	M 2700	98 - On req.	70 Flood (42°)
Chrome 85025	W 3000	107 - 91	
Nickel 85026	N 4000	114 - 97	
	C 5000	139 - 119	

	Cct	lm S - D	Optic
White 88418	M 2700	98 - On req.	12 W.Flood (50°)
Chrome 85013	W 3000	107 - 96	
Nickel 85014	N 4000	114 - 102	
	C 5000	139 - 125	

Électronique

89144	89145	99375	99708	99711	+ driver 24V DC 99374 75W 99331 150W
ON/OFF 1 - 2 art. p 138 x l 22 x h 21	ON/OFF 3 - 6 art. p 138 x l 22 x h 21	ON/OFF 6 - 12 art. p 138 x l 22 x h 21	24V DC converter 0/1-10V 1 - 4 art. p 138 x l 22 x h 21	24V DC converter DALI 1 - 4 art. p 138 x l 22 x h 21	

Boîtier d'encastrement Pag. 414

RTG 91340W70 / 91340N70 / 85025W70 / 85025N70 / 85025C70
85026W70 / 85026N70 / 85027W70 / 86875W70 / 88418W12
85013W12 / 85014W12

Aspho_R | Decorative spotlight | 24 V DC | 5mmLED 1,5 W DC

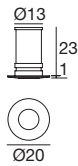

		Cct	Im S - D	Optic
White	91352	Z RGB		30 Flood (45°)
Chrome	86707			
Nickel	86708			

Électronique

99696 + 99702	99331	99278	DMX	99331
Dimmer RF 1-140 art.	CV 24V 150 W p 150 x l 60 x h 35	Dimmer DMX 1-140 art.	DMX Controllers Pag. 952 - 953	CV 24V 150 W p 150 x l 60 x h 35

Boîtier d'encastrement Pag. 414

RTG 91352Z30 / 86708Z30

Aspho_R | Decorative spotlight | powerLED 2,1 W DC 220 mA

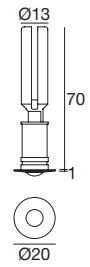

		Cct	Im S - D	Optic
White	91354	Z RGB		70 W.Flood (42°)
Chrome	86730			
Nickel	86731			

		Cct	Im S - D	Optic
White	91362	Z RGB		12 E.W.Flood-
Chrome	87214			
Nickel	87215			

Électronique

99703 + 99702	99333	DMX	Driver	Switching
Dimmer RF 1 - 12 art.	Dimmer DMX 2 - 12 art.	DMX Controllers Pag. 952 - 953	Driver CV 48V Pag. 941	Switching CV 48V Pag. 932

Boîtier d'encastrement Pag. 414

Aspho_Q | Decorative spotlight | 24 V DC | 5mmLED 0,5 W DC

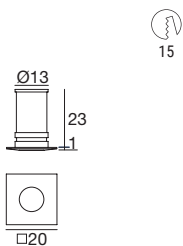

15

	Cct	Im S - D	Optic
White 91339	W 3000	45 - On req.	30 Flood (45°)
Chrome 85004	C 5000	58 - On req.	
Nickel 85005			

Électronique

89408	99374	83018	99332	99722
ON/OFF 1 - 10 art. p 138 x 122 x h 21	ON/OFF 1 - 140 art. p 210 x 148 x h 25	PUSH 1 - 140 art. p 210 x 148 x h 25	0/1-10V 1 - 280 art. p 150 x 160 x h 35	ON/OFF 1 - 220 art. p 191 x 163 x h 38



Boîtier d'encastrement Pag. 414

Aspho_Q | Decorative spotlight | powerLED 1,5 W DC 500 mA

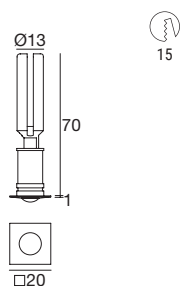

15

CRI 80	Cct	Im S - D	Optic
White 91345	M 2700	130 - On req.	70 Flood (45°)
Chrome 85962	W 3000	143 - 122	
Nickel 85963	N 4000	152 - 130	
	C 5000	185 - 158	

CRI 80	Cct	Im S - D	Optic
White 91347	M 2700	130 - On req.	12 W.Flood (50°)
Chrome 85950	W 3000	143 - 128	
Nickel 85951	N 4000	152 - 136	
	C 5000	185 - 166	

Électronique

99195	89146	99377	99709	99712	+ driver 24V DC 99374 75W 99331 150W
ON/OFF 1 - 2 art. p 138 x 122 x h 21	ON/OFF 2 - 3 art. p 138 x 122 x h 21	ON/OFF 3 - 6 art. p 138 x 122 x h 21	24V DC converter 0/1-10V 1 art. p 138 x 122 x h 21	24V DC converter DALI 1 art. p 138 x 122 x h 21	



Boîtier d'encastrement Pag. 414

414

Aspho_Q | Decorative spotlight | powerLED 1 W DC 350 mA

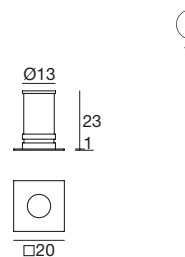

15

CRI 80	Cct	Im S - D	Optic
White 91341	M 2700	98 - On req.	70 Flood (42°)
Chrome 85028	W 3000	107 - 91	
Nickel 85029	N 4000	114 - 97	
	C 5000	139 - 119	

CRI 80	Cct	Im S - D	Optic
White 91343	M 2700	98 - 96	12 W.Flood (50°)
Chrome 85016	W 3000	107 - 91	
Nickel 85017	N 4000	114 - 102	
	C 5000	139 - 125	

Électronique

89144	89145	99375	99708	99711	+ driver 24V DC 99374 75W 99331 150W
ON/OFF 1 - 2 art. p 138 x 122 x h 21	ON/OFF 3 - 6 art. p 138 x 122 x h 21	ON/OFF 6 - 12 art. p 138 x 122 x h 21	24V DC converter 0/1-10V 1 - 4 art. p 138 x 122 x h 21	24V DC converter DALI 1 - 4 art. p 138 x 122 x h 21	



Boîtier d'encastrement Pag. 414

RTG 91341W70

Boîtier d'encastrement

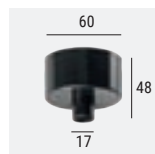

description	type
84916 Boîtier d'encastrement	PVC
suitable for: Aspho_R 0,5W / Aspho_R 1W / Aspho_R 1,5W(RGB) / Aspho_Q 0,5W / Aspho_Q 1W	



description	type
84335 Boîtier d'encastrement	PVC
suitable for: Aspho_R 0,5W / Aspho_R 1W / Aspho_Q 0,5W / Aspho_Q 1W	

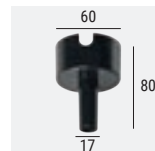

description	type
84917 Boîtier d'encastrement	PVC
suitable for: Aspho_R 1,5W / Aspho_R 2,1W / Aspho_Q 1,5W	





nitum

Matériaux
Corps en laiton ou en acier

Nitum_R | Decorative spotlight | powerLED 1 W DC 350 mA

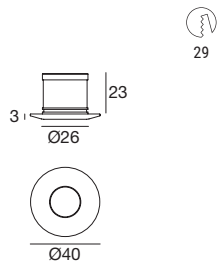

Efficiency - CRI 80	Cct	Im S - D	Optic
White 88421	M 2700	136 - 105	10 Flood (34°)
Chrome 85043	W 3000	145 - 113	30 Flood (45°)
Nickel 85044	N 4000	155 - 120	50 W.Flood (69°)
Steel 86881	C 5000	165 - 137	70 E.W.Flood(77°) 12 E.W.Flood(112°) 00 General (116°)

Électronique

89144	89145	99375	99708	99711	+ driver 24V DC 99374 75W 99331 150W
ON/OFF 1 - 2 art. p 138 x l 22 x h 21	ON/OFF 3 - 6 art. p 138 x l 22 x h 21	ON/OFF 6 - 12 art. p 138 x l 22 x h 21	24V DC converter 0/1-10V 1 - 4 art. p 138 x l 22 x h 21	24V DC converter DALI 1 - 4 art. p 138 x l 22 x h 21	



Boîtier d'encastrement Pag. 419

RTG 88421W30 / 85043W30 / 85044W10
85044W30 / 85044W00 / 85044W50

Nitum_R | Decorative spotlight | powerLED 2 W DC 630 mA

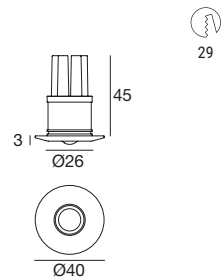

Efficiency - CRI 80	Cct	Im S - D	Optic
White 88423	M 2700	219 - 169	10 Flood (34°)
Chrome 85059	W 3000	233 - 180	30 Flood (45°)
Nickel 85060	N 4000	249 - 193	50 W.Flood (69°)
Steel 86883	C 5000	266 - 220	70 E.W.Flood(77°) 12 E.W.Flood(112°) 00 General (116°)

Électronique

89147	99376	99105	99710	99713	+ driver 24V DC 99374 75W 99331 150W
ON/OFF 1 - 2 art. p 138 x l 22 x h 21	ON/OFF 3 - 6 art. p 138 x l 22 x h 21	ON/OFF 6 - 12 art. p 103 x l 158 x h 27	24V DC converter 0/1-10V 1 art. p 138 x l 22 x h 21	24V DC converter DALI 1 art. p 138 x l 22 x h 21	



Boîtier d'encastrement Pag. 419

RTG 88423M30 / 88423W10 / 88423W30 / 88423W50
88423W00 / 88423N30 / 85059W30 / 85059W50
85060W10 / 85060W30 / 85060W50

Nitum_R | Decorative spotlight | powerLED 2,1 W DC 220 mA

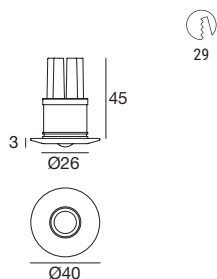

Efficiency - CRI 80	Cct	Im S - D	Optic
White 88568	Z RGB		15 Spot (19°)
Chrome 86612			30 Flood (25°)
Nickel 86613			60 W.Flood (50°)
Steel 86674			00 General (112°)

Électronique

99703 + 99702	99333	DMX	Driver	Switching
Dimmer RF 1 - 12 art.	Dimmer DMX 2 - 12 art.	DMX Controllers Pag. 952 - 953	Driver CV 48V Pag. 941	Switching CV 48V Pag. 932



Boîtier d'encastrement Pag. 419

RTG 88568Z30 / 88568Z60 / 86612Z60

Nitum_Q | Decorative spotlight | powerLED 1 W DC 350 mA

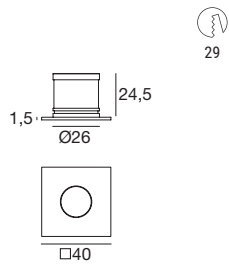

Efficiency - CRI 80	Cct	Im S - D	Optic
White 88422	M 2700	136 - 105	10 Flood (34°)
Chrome 85045	W 3000	145 - 113	30 Flood (45°)
Nickel 85046	N 4000	155 - 120	50 W.Flood (69°)
Steel 86882	C 5000	165 - 137	70 E.W.Flood(77°) 12 E.W.Flood(112°) 00 General (116°)

Électronique

89144	89145	99375	99708	99711	+ driver 24V DC 99374 75W 99331 150W
ON/OFF 1 - 2 art. p 138 x l 22 x h 21	ON/OFF 3 - 6 art. p 138 x l 22 x h 21	ON/OFF 6 - 12 art. p 138 x l 22 x h 21	24V DC converter 0/1-10V 1 - 4 art. p 138 x l 22 x h 21	24V DC converter DALI 1 - 4 art. p 138 x l 22 x h 21	



Boîtier d'encastrement Pag. 419

RTG 88422W30

Nitum_Q | Decorative spotlight | powerLED 2 W DC 630 mA

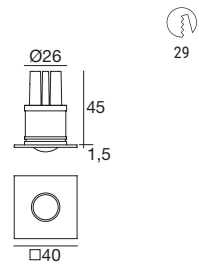

Efficiency - CRI 80	Cct	Im S - D	Optic
White 88424	M 2700	219 - 169	10 Flood (34°)
Chrome 85061	W 3000	233 - 180	30 Flood (45°)
Nickel 85062	N 4000	249 - 193	50 W.Flood (69°)
Steel 86884	C 5000	266 - 220	70 E.W.Flood(77°) 12 E.W.Flood(112°) 00 General (116°)

Électronique

89147	99376	99105	99710	99713	+ driver 24V DC 99374 75W 99331 150W
ON/OFF 1 - 2 art. p 138 x l 22 x h 21	ON/OFF 3 - 6 art. p 138 x l 22 x h 21	ON/OFF 6 - 12 art. p 103 x l 58 x h 27	24V DC converter 0/1-10V 1 art. p 138 x l 22 x h 21	24V DC converter DALI 1 art. p 138 x l 22 x h 21	



Boîtier d'encastrement Pag. 419

RTG 88424W30 / 88424W50 / 85061W30 / 85062W30

Nitum_Q | Decorative spotlight | powerLED 2,1 W DC 220 mA

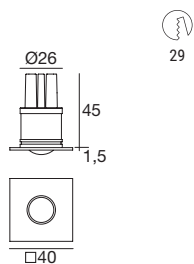

Efficiency - CRI 80	Cct	Im S - D	Optic
White 88569	Z RGB		15 Spot -
Chrome 86614			30 Flood (25°)
Nickel 86615			60 W.Flood (50°)
Steel 86675			00 General (112°)

Électronique

99703 + 99702	99333	DMX	Driver	Switching
Dimmer RF 1 - 12 art.	Dimmer DMX 2 - 12 art.	DMX Controllers Pag. 952 - 953	Driver CV 48V Pag. 941	Switching CV 48V Pag. 932



Boîtier d'encastrement Pag. 419

Boîtier d'encastrement



	description	type
84915	Boîtier d'encastrement	PVC
suitable for: Nitum_R 1W / Nitum_Q 1W		



	description	type
84901	Boîtier d'encastrement	PVC
suitable for: Nitum_R 2W / Nitum_R 2,1W Nitum_Q 2W / Nitum_Q 2,1W		



	description	type
84336	Boîtier d'encastrement	PVC
suitable for: Nitum_R 1W / Nitum_Q 1W		

Watergate hotel | Washington, USA





picrol

Matériaux

Corps laiton ou en polyamide

Picrol | Decorative spotlight | powerLED 1 W DC 350 mA

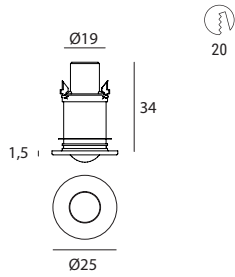

Efficiency - CRI 80		Cct	Im S - D	Optic
White	92256	M 2700	136 - On req	30 Flood (44°)
Black	92258	W 3000	145 - 100	50 W.Flood (51°)
Chrome	92259	N 4000	155 - 106	70 E.W.Flood(75°)
		C 5000	165 - 121	

Électronique

89144	89145	99375	99708	99711	+ driver 24V DC
ON/OFF 1 - 2 art. p 138 x l 22 x h 21	ON/OFF 3 - 6 art. p 138 x l 22 x h 21	ON/OFF 6 - 12 art. p 138 x l 22 x h 21	24V DC converter 0/1-10V 1 - 4 art. p 138 x l 22 x h 21	24V DC converter DALI 1 - 4 art. p 138 x l 22 x h 21	99374 75W 99331 150W



Boîtier d'encastrement Pag. 421

RTG 92256W30 / 92256W70 / 92258W30 / 92259W30

Picrol | Decorative spotlight | powerLED 1,5 W DC 500 mA

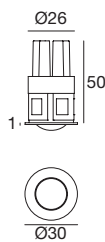

Efficiency - CRI 80		Cct	Im S - D	Optic
White	91365	M 2700	187 - On req	10 Spot -
Chrome	86408	W 3000	199 - On req	30 Flood -
		N 4000	213 - On req	50 W.Flood -
				70 E.W.Flood-
				12 E.W.Flood-
				00 General (117°)

Électronique

99195	89146	99377	99709	99712	+ driver 24V DC
ON/OFF 1 - 2 art. p 138 x l 22 x h 21	ON/OFF 2 - 3 art. p 138 x l 22 x h 21	ON/OFF 3 - 6 art. p 138 x l 22 x h 21	24V DC converter 0/1-10V 1 art. p 138 x l 22 x h 21	24V DC converter DALI 1 art. p 138 x l 22 x h 21	99374 75W 99331 150W



Boîtier d'encastrement Pag. 421

Small Spotlight

Picrol | Decorative spotlight | powerLED 1 W DC 350 mA

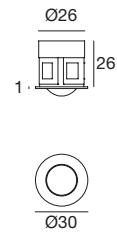

Efficiency - CRI 80		Cct	Im S - D	Optic
White	91364	M 2700	136 - On req	10 Spot -
Chrome	86407	W 3000	145 - On req	30 Flood -
		N 4000	155 - On req	50 W.Flood -
				70 E.W.Flood-
				12 E.W.Flood-
				00 General -

Électronique

89144	89145	99375	99708	99711	+ driver 24V DC
ON/OFF 1 - 2 art. p 138 x l 22 x h 21	ON/OFF 3 - 6 art. p 138 x l 22 x h 21	ON/OFF 6 - 12 art. p 138 x l 22 x h 21	24V DC converter 0/1-10V 1 - 4 art. p 138 x l 22 x h 21	24V DC converter DALI 1 - 4 art. p 138 x l 22 x h 21	99374 75W 99331 150W



Boîtier d'encastrement Pag. 421

Boîtier d'encastrement



description	type
98049 Boîtier d'encastrement	PVC
suitable for: Picrol 1W Ø25	



description	type
84901 Boîtier d'encastrement	PVC
suitable for: Picrol 1,5W	

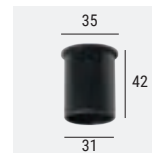

description	type
84336 Boîtier d'encastrement	PVC
suitable for: Picrol 1W Ø30	



description	type
84955 Boîtier d'encastrement	PVC
suitable for: Picrol 1W Ø30	

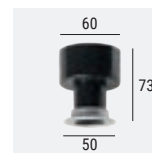

description	type
84956 Boîtier d'encastrement	PVC
suitable for: Picrol 1,5W	



ghilea

Matériaux
Corps en aluminium

Ghilea | Decorative spotlight | powerLED 2 W DC 630 mA

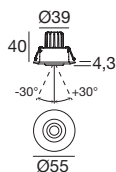

Efficiency - CRI 80	Cct	lm S - D	Optic
White 97044	M 2700	219 - 146	15 Spot (21°)
Black 97045	W 3000	233 - 155	30 Flood (32°)
Nickel 97189	N 4000	249 - 166	
Chrome 97047			

Électronique

89147	99376	99105	99710	99713	+ driver 24V DC
ON/OFF 1 - 2 art. p 138 x l 22 x h 21	ON/OFF 3 - 6 art. p 138 x l 22 x h 21	ON/OFF 6 - 12 art. p 103 x l 58 x h 27	24V DC converter 0/1-10V 1 art. p 138 x l 22 x h 21	24V DC converter DALI 1 art. p 138 x l 22 x h 21	99374 75W 99331 150W



Boîtier d'encastrement Pag. 423

RTG 97044W30

Eos Hotel | Lecce, Italy



Small Spotlight

Boîtier d'encastrement

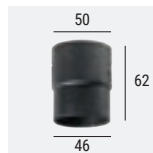

	description	type
84902	Boîtier d'encastrement	PVC

suitable for: Ghilea



crystals

Matériaux

Corps en laiton

Diffuseur en cristal prismatique transparent



Beriel | Crystal spotlight | powerLED 1 W DC 350 mA

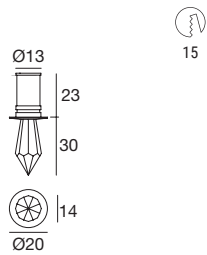

Efficiency - CRI 80	Cct	lm S - D	Optic
Chrome 92285	M 2700	107 - On req	00 General -
	W 3000	114 - On req	
	N 4000	139 - On req	

Électronique

89144	89145	99375	99708	99711	+ driver 24V DC 99374 75W 99331 150W
ON/OFF 1 - 2 art. p 138 x l 22 x h 21	ON/OFF 3 - 6 art. p 138 x l 22 x h 21	ON/OFF 6 - 12 art. p 138 x l 22 x h 21	24V DC converter 0/1-10V 1 - 4 art. p 138 x l 22 x h 21	24V DC converter DALI 1 - 4 art. p 138 x l 22 x h 21	



Boîtier d'encastrement Pag. 433

RTG 92285W00

Beriel | Crystal spotlight | powerLED 1,5 W DC 500 mA

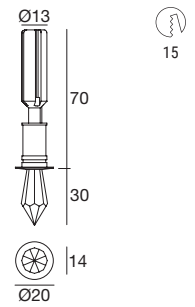

Efficiency - CRI 80	Cct	lm S - D	Optic
Chrome 87324	M 2700	143 - On req	00 General -
	W 3000	152 - On req	
	N 4000	185 - On req	

Électronique

99195	89146	99377	99709	99712	+ driver 24V DC 99374 75W 99331 150W
ON/OFF 1 - 2 art. p 138 x l 22 x h 21	ON/OFF 2 - 3 art. p 138 x l 22 x h 21	ON/OFF 3 - 6 art. p 138 x l 22 x h 21	24V DC converter 0/1-10V 1 art. p 138 x l 22 x h 21	24V DC converter DALI 1 art. p 138 x l 22 x h 21	



Boîtier d'encastrement Pag. 433

RTG 87324W00

Beriel | Crystal spotlight | powerLED 2,1 W DC 220 mA

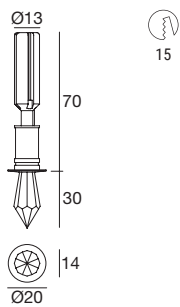

Cct	lm S - D	Optic
Chrome 87325	Z RGB	00 General -

Électronique

99703 + 99702	99333	DMX	Driver	Switching
Dimmer RF 1 - 12 art.	Dimmer DMX 2 - 12 art.	DMX Controllers Pag. 952 - 953	Driver CV 48V Pag. 941	Switching CV 48V Pag. 932



Boîtier d'encastrement Pag. 433

Beriel | Crystal spotlight | powerLED 1 W DC 350 mA

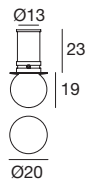

Efficiency - CRI 80	Cct	lm S - D	Optic
Chrome 83681	M 2700	107 - On req	00 General -
	W 3000	114 - On req	
	N 4000	139 - On req	

Électronique

89144	89145	99375	99708	99711	+ driver 24V DC 99374 75W 99331 150W
ON/OFF 1 - 2 art. p 138 x 122 x h 21	ON/OFF 3 - 6 art. p 138 x 122 x h 21	ON/OFF 6 - 12 art. p 138 x 122 x h 21	24V DC converter 0/1-10V 1 - 4 art. p 138 x 122 x h 21	24V DC converter DALI 1 - 4 art. p 138 x 122 x h 21	



Boîtier d'encastrement Pag. 433

Beriel | Crystal spotlight | powerLED 1,5 W DC 500 mA

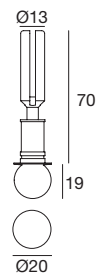

Efficiency - CRI 80	Cct	lm S - D	Optic
Chrome 83682	M 2700	143 - On req	00 General -
	W 3000	152 - On req	
	N 4000	185 - On req	

Électronique

99195	89146	99377	99709	99712	+ driver 24V DC 99374 75W 99331 150W
ON/OFF 1 - 2 art. p 138 x 122 x h 21	ON/OFF 2 - 3 art. p 138 x 122 x h 21	ON/OFF 3 - 6 art. p 138 x 122 x h 21	24V DC converter 0/1-10V 1 art. p 138 x 122 x h 21	24V DC converter DALI 1 art. p 138 x 122 x h 21	



Boîtier d'encastrement Pag. 433

Beriel | Crystal spotlight | powerLED 2,1 W DC 220 mA

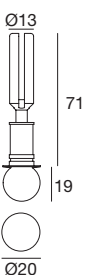

Efficiency - CRI 80	Cct	lm S - D	Optic
Chrome 83683	Z RGB		00 General -

Électronique

99703 + 99702	99333	DMX	Driver	Switching
Dimmer RF 1 - 12 art.	Dimmer DMX 2 - 12 art.	DMX Controllers Pag. 952 - 953	Driver CV 48V Pag. 941	Switching CV 48V Pag. 932



Boîtier d'encastrement Pag. 433

Beriel | Crystal spotlight | powerLED 1 W DC 350 mA

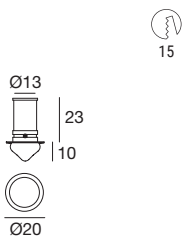

Efficiency - CRI 80		Cct	lm S - D	Optic
Chrome	83678	M 2700	107 - On req	00 General -
		W 3000	114 - On req	
		N 4000	139 - On req	

Électronique

89144	89145	99375	99708	99711	+ driver 24V DC 99374 75W 99331 150W
ON/OFF 1 - 2 art. p 138 x l 22 x h 21	ON/OFF 3 - 6 art. p 138 x l 22 x h 21	ON/OFF 6 - 12 art. p 138 x l 22 x h 21	24V DC converter 0/1-10V 1 - 4 art. p 138 x l 22 x h 21	24V DC converter DALI 1 - 4 art. p 138 x l 22 x h 21	



Boîtier d'encastrement Pag. 433

Beriel | Crystal spotlight | powerLED 1,5 W DC 500 mA

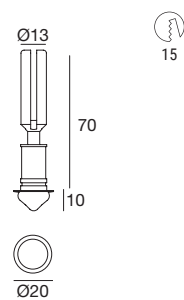

Efficiency - CRI 80		Cct	lm S - D	Optic
Chrome	83679	M 2700	143 - On req	00 General -
		W 3000	152 - On req	
		N 4000	185 - On req	

Électronique

99195	89146	99377	99709	99712	+ driver 24V DC 99374 75W 99331 150W
ON/OFF 1 - 2 art. p 138 x l 22 x h 21	ON/OFF 2 - 3 art. p 138 x l 22 x h 21	ON/OFF 3 - 6 art. p 138 x l 22 x h 21	24V DC converter 0/1-10V 1 art. p 138 x l 22 x h 21	24V DC converter DALI 1 art. p 138 x l 22 x h 21	



Boîtier d'encastrement Pag. 433

Beriel | Crystal spotlight | powerLED 2,1 W DC 220 mA

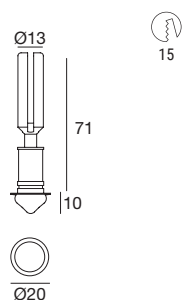

Efficiency - CRI 80		Cct	lm S - D	Optic
Chrome	83680	Z RGB		00 General -

Électronique

99703 + 99702	99333	DMX	Driver	Switching
Dimmer RF 1 - 12 art.	Dimmer DMX 2 - 12 art.	DMX Controllers Pag. 952 - 953	Driver CV 48V Pag. 941	Switching CV 48V Pag. 932



Boîtier d'encastrement Pag. 433

Beriel | Crystal spotlight | powerLED 1 W DC 350 mA

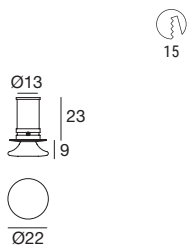

15

Efficiency - CRI 80	Cct	lm S - D	Optic
Chrome 83675	M 2700	107 - On req	00 General -
	W 3000	114 - On req	
	N 4000	139 - On req	

Électronique

89144	89145	99375	99708	99711	+ driver 24V DC 99374 75W 99331 150W
ON/OFF 1 - 2 art. p 138 x 122 x h 21	ON/OFF 3 - 6 art. p 138 x 122 x h 21	ON/OFF 6 - 12 art. p 138 x 122 x h 21	24V DC converter 0/1-10V 1 - 4 art. p 138 x 122 x h 21	24V DC converter DALI 1 - 4 art. p 138 x 122 x h 21	



Boîtier d'encastrement Pag. 433

Beriel | Crystal spotlight | powerLED 1,5 W DC 500 mA

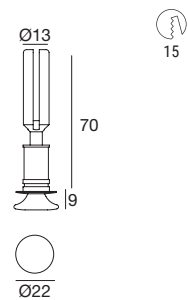

15

Efficiency - CRI 80	Cct	lm S - D	Optic
Chrome 83676	M 2700	143 - On req	00 General -
	W 3000	152 - On req	
	N 4000	185 - On req	

Électronique

99195	89146	99377	99709	99712	+ driver 24V DC 99374 75W 99331 150W
ON/OFF 1 - 2 art. p 138 x 122 x h 21	ON/OFF 2 - 3 art. p 138 x 122 x h 21	ON/OFF 3 - 6 art. p 138 x 122 x h 21	24V DC converter 0/1-10V 1 art. p 138 x 122 x h 21	24V DC converter DALI 1 art. p 138 x 122 x h 21	



Boîtier d'encastrement Pag. 433

Beriel | Crystal spotlight | powerLED 2,1 W DC 220 mA

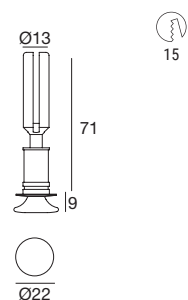

15

Efficiency - CRI 80	Cct	lm S - D	Optic
Chrome 83677	Z RGB		00 General -

Électronique

99703 + 99702	99333	DMX	Driver	Switching
Dimmer RF 1 - 12 art.	Dimmer DMX 2 - 12 art.	DMX Controllers Pag. 952 - 953	Driver CV 48V Pag. 941	Switching CV 48V Pag. 932



Boîtier d'encastrement Pag. 433

Elin | Crystal spotlight | 24 V DC | 5mmLED 0,5 W DC

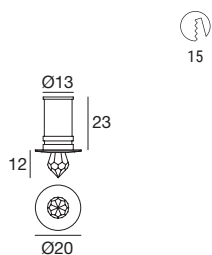

	Cct	Im S - D	Optic
Chrome 87337	W 3000 C 5000 R - G - B - Y On request	On request On request	00 General -

Électronique

89408	99374	83018	99332	99722
ON/OFF 1 - 10 art. p 138 x l 22 x h 21	ON/OFF 1 - 140 art. p 210 x l 48 x h 25	PUSH 1 - 140 art. p 210 x l 48 x h 25	0/1-10V 1 - 280 art. p 150 x l 60 x h 35	ON/OFF 1 - 220 art. p 191 x l 63 x h 38



Boîtier d'encastrement Pag. 433

RTG 87337W00

Elin | Crystal spotlight | powerLED 1 W DC 350 mA

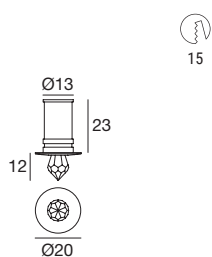

	Cct	Im S - D	Optic
Chrome 91200	W 3000 N 4000 C 5000	107 - On req 114 - On req 139 - On req	00 General -

Électronique

89144	89145	99375	99708	99711	+ driver 24V DC 99374 75W 99331 150W
ON/OFF 1 - 2 art. p 138 x l 22 x h 21	ON/OFF 3 - 6 art. p 138 x l 22 x h 21	ON/OFF 6 - 12 art. p 138 x l 22 x h 21	24V DC converter 0/1-10V 1 - 4 art. p 138 x l 22 x h 21	24V DC converter DALI 1 - 4 art. p 138 x l 22 x h 21	



Boîtier d'encastrement Pag. 433

RTG 91200W00

Elin | Crystal spotlight | 24 V DC | 5mmLED 0,5 W DC

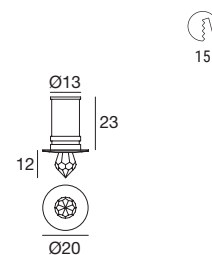

	Cct	Im S - D	Optic
Chrome 87340	Z RGB		00 General -

Électronique

99696 + 99702	99331	99278	DMX	99331
Dimmer RF 1-140 art.	CV 24V 150 W p 150 x l 60 x h 35	Dimmer DMX 1-140 art.	DMX Controllers Pag. 952 - 953	CV 24V 150 W p 150 x l 60 x h 35



Boîtier d'encastrement Pag. 433

RTG 87340Z00

Elin | Crystal spotlight | powerLED 1,5 W DC 500 mA

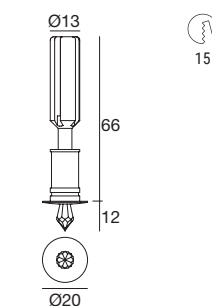

	Cct	Im S - D	Optic
Chrome 87323	W 3000 N 4000 C 5000	143 - 45 152 - 47 185 - On req	00 W.Flood (48°)

Électronique

99195	89146	99377	99709	99712	+ driver 24V DC 99374 75W 99331 150W
ON/OFF 1 - 2 art. p 138 x l 22 x h 21	ON/OFF 2 - 3 art. p 138 x l 22 x h 21	ON/OFF 3 - 6 art. p 138 x l 22 x h 21	24V DC converter 0/1-10V 1 art. p 138 x l 22 x h 21	24V DC converter DALI 1 art. p 138 x l 22 x h 21	



Boîtier d'encastrement Pag. 433

Ture | Crystal spotlight | powerLED 1,5 W DC 500 mA

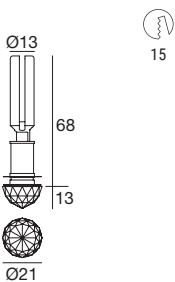

Efficiency - CRI 80	Cct	lm S - D	Optic
Chrome 87350	M 2700	143 - On req	00 General -
	W 3000	152 - On req	
	N 4000	185 - On req	

Électronique

99195	89146	99377	99709	99712	+ driver 24V DC 99374 75W 99331 150W
ON/OFF 1 - 2 art. p 138 x l 22 x h 21	ON/OFF 2 - 3 art. p 138 x l 22 x h 21	ON/OFF 3 - 6 art. p 138 x l 22 x h 21	24V DC converter 0/1-10V 1 art. p 138 x l 22 x h 21	24V DC converter DALI 1 art. p 138 x l 22 x h 21	



Boîtier d'encastrement Pag. 433

Ture | Crystal spotlight | powerLED 1,5 W DC 500 mA

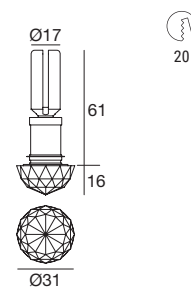

Efficiency - CRI 80	Cct	lm S - D	Optic
Chrome 87353	M 2700	199 - On req	00 General -
	W 3000	213 - On req	
	N 4000	227 - On req	

Électronique

99195	89146	99377	99709	99712	+ driver 24V DC 99374 75W 99331 150W
ON/OFF 1 - 2 art. p 138 x l 22 x h 21	ON/OFF 2 - 3 art. p 138 x l 22 x h 21	ON/OFF 3 - 6 art. p 138 x l 22 x h 21	24V DC converter 0/1-10V 1 art. p 138 x l 22 x h 21	24V DC converter DALI 1 art. p 138 x l 22 x h 21	



Boîtier d'encastrement Pag. 433

Ture | Crystal spotlight | powerLED 1,5 W DC 500 mA

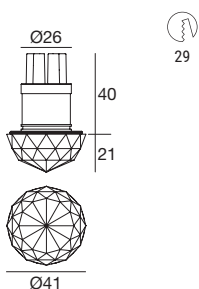

Efficiency - CRI 80	Cct	lm S - D	Optic
Chrome 87356	M 2700	199 - On req	00 General -
	W 3000	213 - On req	
	N 4000	227 - On req	

Électronique

99195	89146	99377	99709	99712	+ driver 24V DC 99374 75W 99331 150W
ON/OFF 1 - 2 art. p 138 x l 22 x h 21	ON/OFF 2 - 3 art. p 138 x l 22 x h 21	ON/OFF 3 - 6 art. p 138 x l 22 x h 21	24V DC converter 0/1-10V 1 art. p 138 x l 22 x h 21	24V DC converter DALI 1 art. p 138 x l 22 x h 21	



Boîtier d'encastrement Pag. 433

Gude | Crystal spotlight | powerLED 1,5 W DC 500 mA

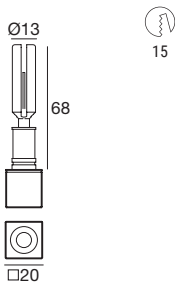

15

Efficiency - CRI 80	Cct	lm S - D	Optic
Chrome 87330	M 2700	143 - 92	00 E.W.Flood(93°)
	W 3000	152 - 98	
	N 4000	185 - 119	

Électronique

99195	89146	99377	99709	99712	+ driver 24V DC 99374 75W 99331 150W
ON/OFF 1 - 2 art. p 138 x l 22 x h 21	ON/OFF 2 - 3 art. p 138 x l 22 x h 21	ON/OFF 3 - 6 art. p 138 x l 22 x h 21	24V DC converter 0/1-10V 1 art. p 138 x l 22 x h 21	24V DC converter DALI 1 art. p 138 x l 22 x h 21	

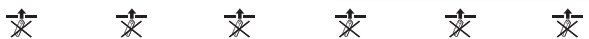

Boîtier d'encastrement Pag. 433

Gude | Crystal spotlight | powerLED 1,5 W DC 500 mA

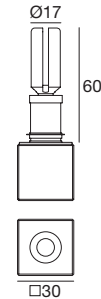

20

Efficiency - CRI 80	Cct	lm S - D	Optic
Chrome 87332	M 2700	199 - 115	00 E.W.Flood(93°)
	W 3000	213 - 123	
	N 4000	227 - 139	

Électronique

99195	89146	99377	99709	99712	+ driver 24V DC 99374 75W 99331 150W
ON/OFF 1 - 2 art. p 138 x l 22 x h 21	ON/OFF 2 - 3 art. p 138 x l 22 x h 21	ON/OFF 3 - 6 art. p 138 x l 22 x h 21	24V DC converter 0/1-10V 1 art. p 138 x l 22 x h 21	24V DC converter DALI 1 art. p 138 x l 22 x h 21	



Boîtier d'encastrement Pag. 433

Gude | Crystal spotlight | powerLED 1,5 W DC 500 mA

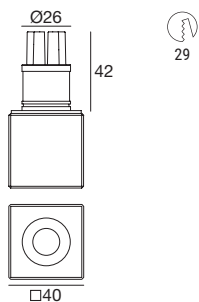

29

Efficiency - CRI 80	Cct	lm S - D	Optic
Chrome 87335	M 2700	199 - 115	00 E.W.Flood(93°)
	W 3000	213 - 123	
	N 4000	227 - 139	

Électronique

99195	89146	99377	99709	99712	+ driver 24V DC 99374 75W 99331 150W
ON/OFF 1 - 2 art. p 138 x l 22 x h 21	ON/OFF 2 - 3 art. p 138 x l 22 x h 21	ON/OFF 3 - 6 art. p 138 x l 22 x h 21	24V DC converter 0/1-10V 1 art. p 138 x l 22 x h 21	24V DC converter DALI 1 art. p 138 x l 22 x h 21	

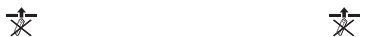

Boîtier d'encastrement Pag. 433

Boîtier d'encastrement



	description	type
84335	Boîtier d'encastrement	PVC
suitable for: Beriel 1W / Elin 0,5W / Elin 1W		

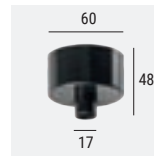

	description	type
84916	Boîtier d'encastrement	PVC
suitable for: Elin 0,5W / Elin 1W		

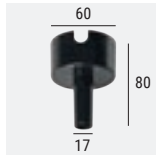

	description	type
84917	Boîtier d'encastrement	PVC
suitable for: Beriel 1,5W / Beriel 2,1W Elin 1,5W / Ture 1,5W Ø13 / Gude 1,5W 20mm		

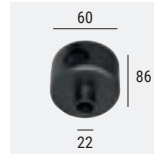

	description	type
84954	Boîtier d'encastrement	PVC
suitable for: Ture 1,5W Ø31 / Gude 1,5W 30mm		



	description	type
84901	Boîtier d'encastrement	PVC
suitable for: Ture 1,5W Ø41 / Gude 1,5W 40mm		



calypto

Matériaux
Corps en laiton

Calypto | Movable spotlight | powerLED 1,5 W DC 500 mA

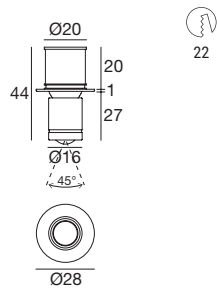

Efficiency - CRI 80	Cct	lm S - D	Optic
Chrome 87067	W 3000	199 - 154	30 Flood (45°)
Nickel 87068	N 4000	213 - 165	50 W.Flood (69°)
			70 E.W.Flood(77°)

Électronique

99195	89146	99377	99709	99712	+ driver 24V DC 99374 75W 99331 150W
ON/OFF 1 - 2 art. p 138 x l 22 x h 21	ON/OFF 2 - 3 art. p 138 x l 22 x h 21	ON/OFF 3 - 6 art. p 138 x l 22 x h 21	24V DC converter 0/1-10V 1 art. p 138 x l 22 x h 21	24V DC converter DALI 1 art. p 138 x l 22 x h 21	



Boîtier d'encastrement Pag. 435

Boîtier d'encastrement



description	type
84349 Boîtier d'encastrement	PVC

suitable for: Calypto

Small Spotlight

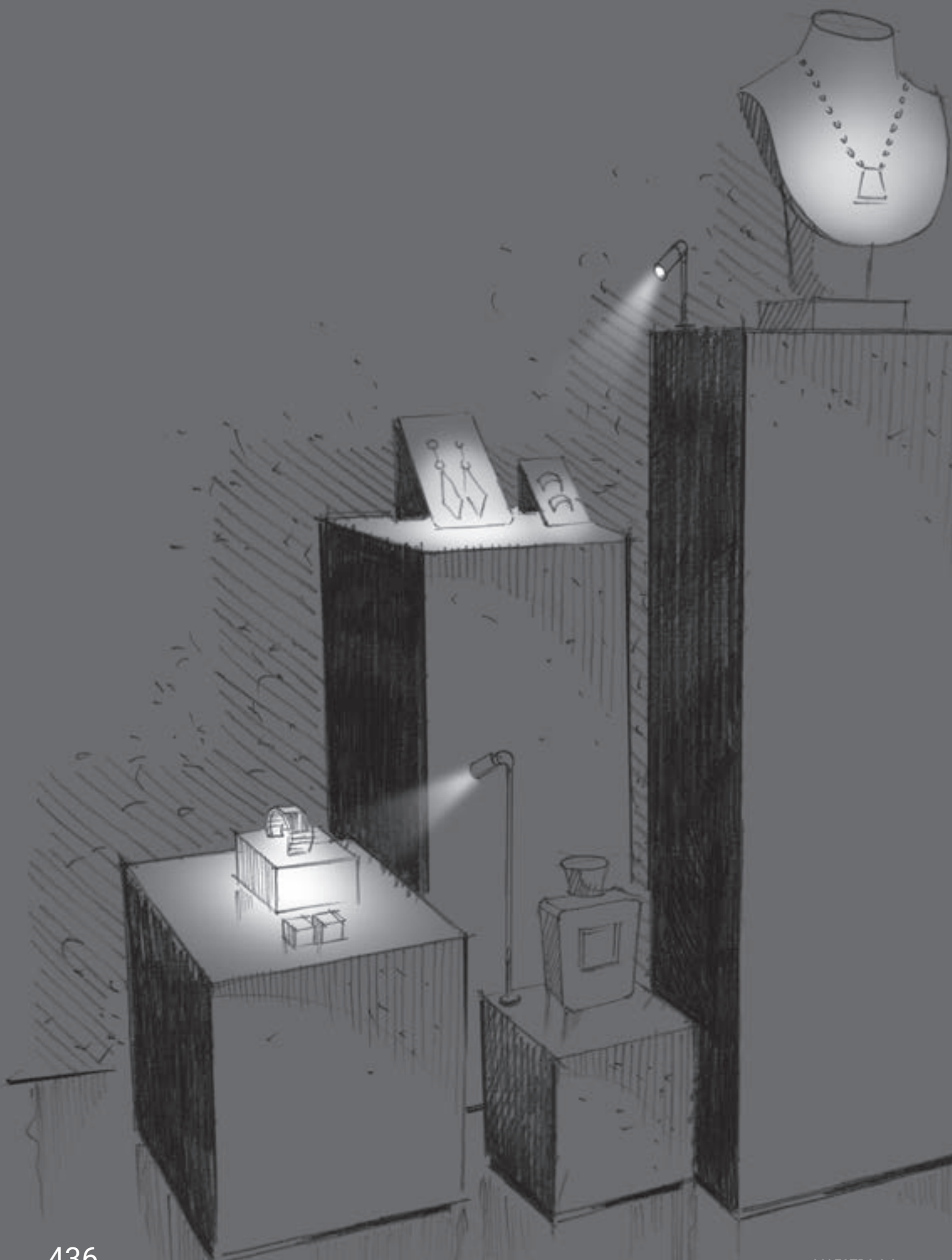

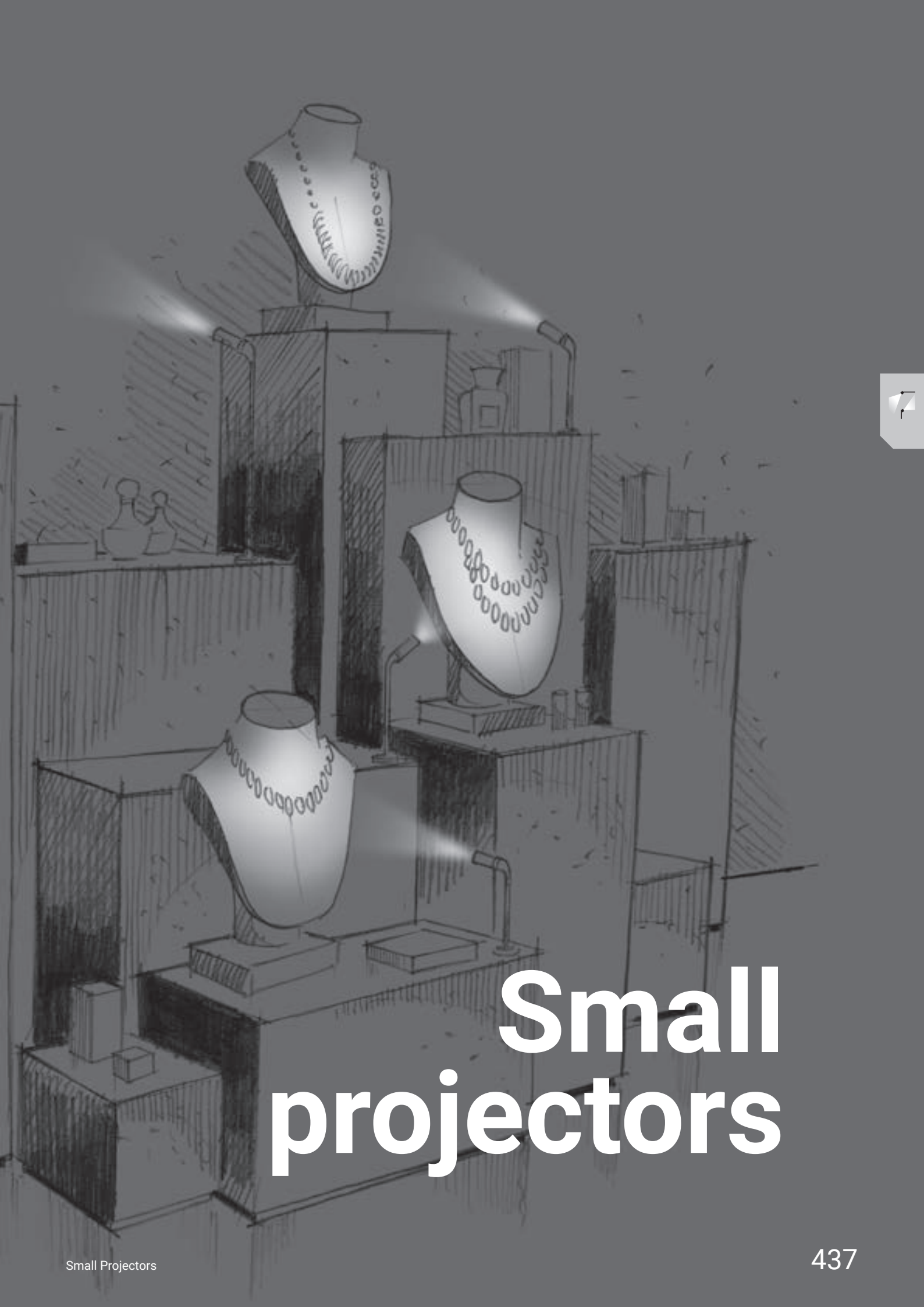

Small projectors

small projectors range index

Eyelet

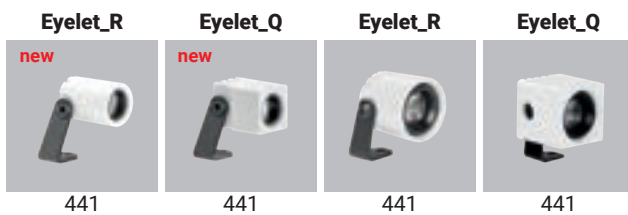

Tee

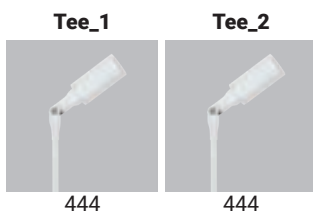





eyelet

Matériaux
Corps en aluminium

Eyelet_R | Movable spotlight | powerLED 1 W DC 350 mA

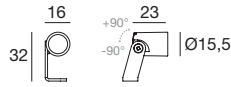

Efficiency - CRI 80		Cct	lm S - D	Optic	
White	82619	M 2700	145 - On req	20 Spot	-
Black	82620	W 3000	145 - On req	35 Flood	-
Grey	82621	N 4000	155 - On req		

Électronique

89144	89145	99375	99708	99711	+ driver 24V DC
ON/OFF 1 - 2 art. p 138 x 1 22 x h 21	ON/OFF 3 - 6 art. p 138 x 1 22 x h 21	ON/OFF 6 - 12 art. p 138 x 1 22 x h 21	24V DC converter 0/1-10V 1 - 4 art. p 138 x 1 22 x h 21	24V DC converter DALI 1 - 4 art. p 138 x 1 22 x h 21	99374 75W 99331 150W

RTG 82619W20

Eyelet_Q | Movable spotlight | powerLED 1 W DC 350 mA

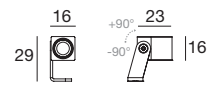

Efficiency - CRI 80		Cct	lm S - D	Optic	
White	82622	M 2700	145 - On req	20 Spot	-
Black	82623	W 3000	145 - On req	35 Flood	-
Grey	82624	N 4000	155 - On req		

Électronique

89144	89145	99375	99708	99711	+ driver 24V DC
ON/OFF 1 - 2 art. p 138 x 1 22 x h 21	ON/OFF 3 - 6 art. p 138 x 1 22 x h 21	ON/OFF 6 - 12 art. p 138 x 1 22 x h 21	24V DC converter 0/1-10V 1 - 4 art. p 138 x 1 22 x h 21	24V DC converter DALI 1 - 4 art. p 138 x 1 22 x h 21	99374 75W 99331 150W

RTG 82622W20

Eyelet_R | Movable spotlight | powerLED 2 W DC 630 mA

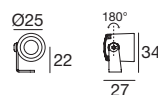

Efficiency - CRI 80		Cct	lm S - D	Optic	
White	96984	M 2700	219 - 172	15 Spot	(18°)
Black	96985	W 3000	233 - 154	30 Flood	(27°)
Grey	96986	N 4000	249 - 165	60 W.Flood	(63°)

Électronique

89147	99376	99105	99710	99713	+ driver 24V DC
ON/OFF 1 - 2 art. p 138 x 1 22 x h 21	ON/OFF 3 - 6 art. p 138 x 1 22 x h 21	ON/OFF 6 - 12 art. p 103 x 1 58 x h 27	24V DC converter 0/1-10V 1 art. p 138 x 1 22 x h 21	24V DC converter DALI 1 art. p 138 x 1 22 x h 21	99374 75W 99331 150W

Eyelet_Q | Movable spotlight | powerLED 2 W DC 630 mA

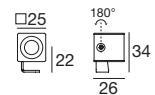

Efficiency - CRI 80		Cct	lm S - D	Optic	
White	97336	M 2700	219 - 172	15 Spot	(18°)
Black	97337	W 3000	233 - 154	30 Flood	(27°)
Grey	97338	N 4000	249 - 165	60 W.Flood	(63°)

Électronique

89147	99376	99105	99710	99713	+ driver 24V DC
ON/OFF 1 - 2 art. p 138 x 1 22 x h 21	ON/OFF 3 - 6 art. p 138 x 1 22 x h 21	ON/OFF 6 - 12 art. p 103 x 1 58 x h 27	24V DC converter 0/1-10V 1 art. p 138 x 1 22 x h 21	24V DC converter DALI 1 art. p 138 x 1 22 x h 21	99374 75W 99331 150W

tee

Matériaux
Corps en aluminium



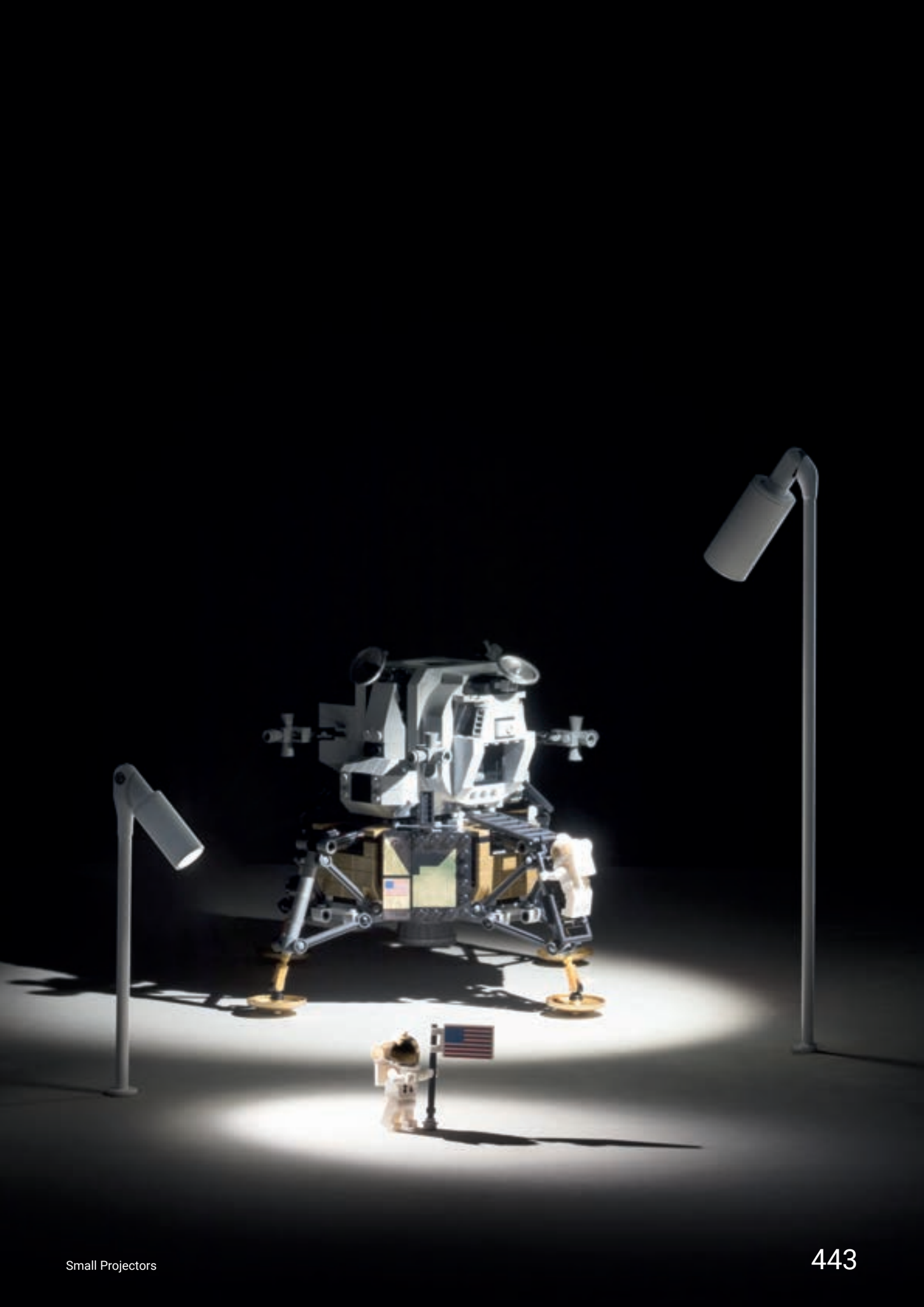

Tee_1 | Movable Spotlight | powerLED 1 W DC 350 mA



H. 23 mm - CRI 80	Cct	lm S - D	Optic
White 90503	W 3000	146 - 56	85 Adjust. 13° - 43°
Black 90504	N 4000	156 - 60	
Chrome 90505	C 5000	166 - 63	
Nickel 90506			

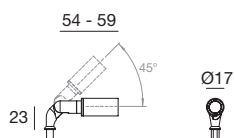

H. 100 mm - CRI 80	Cct	lm S - D	Optic
White 90499	W 3000	146 - 56	85 Adjust. 13° - 43°
Black 90500	N 4000	156 - 60	
Chrome 90501	C 5000	166 - 63	
Nickel 90502			

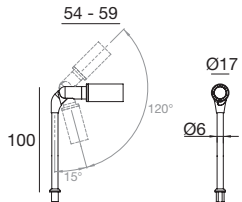

H. 300 mm - CRI 80	Cct	lm S - D	Optic
White 90495	W 3000	146 - 56	85 Adjust. 13° - 43°
Black 90496	N 4000	156 - 60	
Chrome 90497	C 5000	166 - 63	
Nickel 90498			

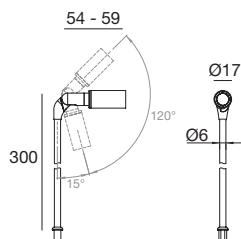

Électronique

89144	89145	99375	99708	99711	+ driver 24V DC 99374 75W 99331 150W
ON/OFF 1 - 2 art. p 138 x l 22 x h 21	ON/OFF 3 - 6 art. p 138 x l 22 x h 21	ON/OFF 6 - 12 art. p 138 x l 22 x h 21	24V DC converter 0/1-10V 1 - 4 art. p 138 x l 22 x h 21	24V DC converter DALI 1 - 4 art. p 138 x l 22 x h 21	

Tee_2 | Movable Spotlight | powerLED 2 W DC 630 mA



H. 23 mm - CRI 80	Cct	lm S - D	Optic
White 90515	W 3000	233 - On req	85 Adjust. 13° - 53°
Black 90516	N 4000	249 - On req	
Chrome 90517	C 5000	266 - On req	
Nickel 90518			

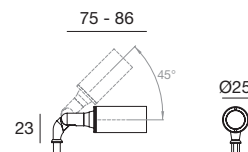

H. 100 mm - CRI 80	Cct	lm S - D	Optic
White 90511	W 3000	233 - On req	85 Adjust. 13° - 53°
Black 90512	N 4000	249 - On req	
Chrome 90513	C 5000	266 - On req	
Nickel 90514			

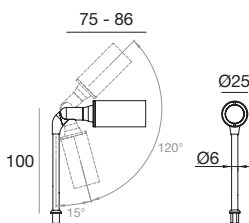

H. 300 mm - CRI 80	Cct	lm S - D	Optic
White 90507	W 3000	233 - On req	85 Adjust. 13° - 53°
Black 90508	N 4000	249 - On req	
Chrome 90509	C 5000	266 - On req	
Nickel 90510			

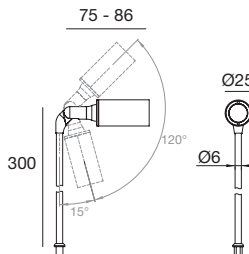

Électronique

89147	99376	99105	99710	99713	+ driver 24V DC 99374 75W 99331 150W
ON/OFF 1 - 2 art. p 138 x l 22 x h 21	ON/OFF 3 - 6 art. p 138 x l 22 x h 21	ON/OFF 6 - 12 art. p 103 x l 58 x h 27	24V DC converter 0/1-10V 1 art. p 138 x l 22 x h 21	24V DC converter DALI 1 art. p 138 x l 22 x h 21	

Tee_1 & Tee_2 | Accessoire de fixation à ressort pour installation encastrée

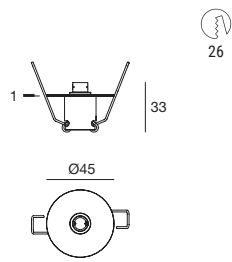

98972	White
98973	Black
98974	Chrome
98975	Nickel

Tee_1 & Tee_2 | Accessoire avec tige filetée pour installation encastrée

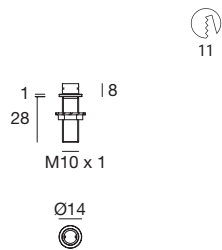

98980	White
98981	Black
98982	Chrome
98983	Nickel

Tee_1 & Tee_2 | Accessoire avec vis de fixation pour installation en surface

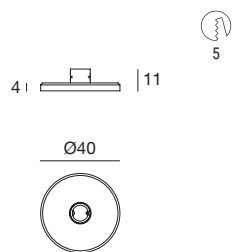

98976	White
98977	Black
98978	Chrome
98979	Nickel

Tee_1 & Tee_2 | Base porte-driver pour installation au plafond (driver non inclus)

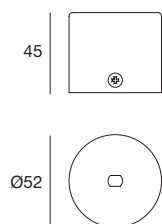

99503	White
99504	Black
99505	Chrome
99506	Nickel

Tee_1 driver



89148
ON/OFF
1 - 2 art.
Pour base

Tee_2 driver



89151
ON/OFF
1 - 2 art.
Pour base

Environment Care Lighting

In collaboration with



Lumière utile,
garantissant santé
et bien-être quotidien,
quels que soient le
moment et l'endroit.

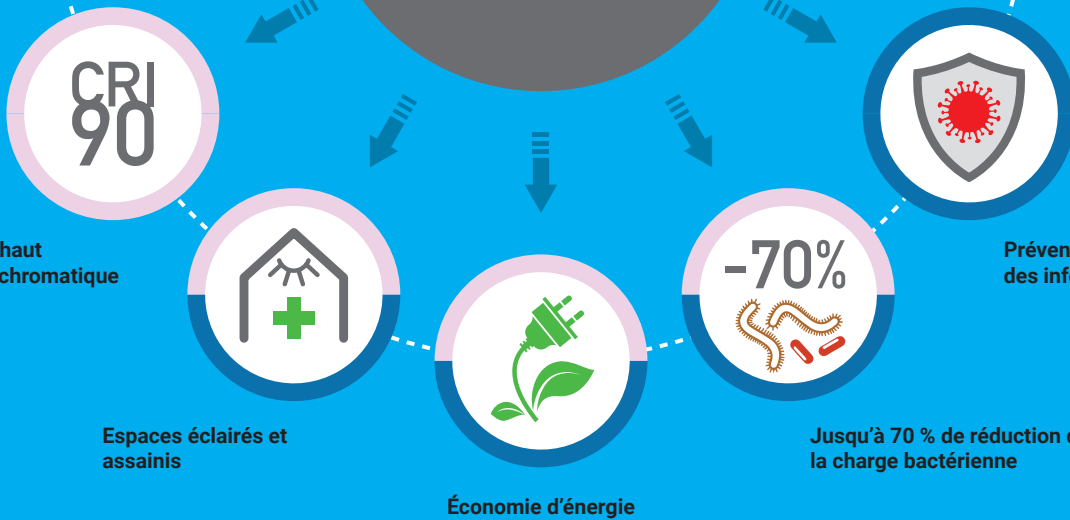

Lieux d'utilisation

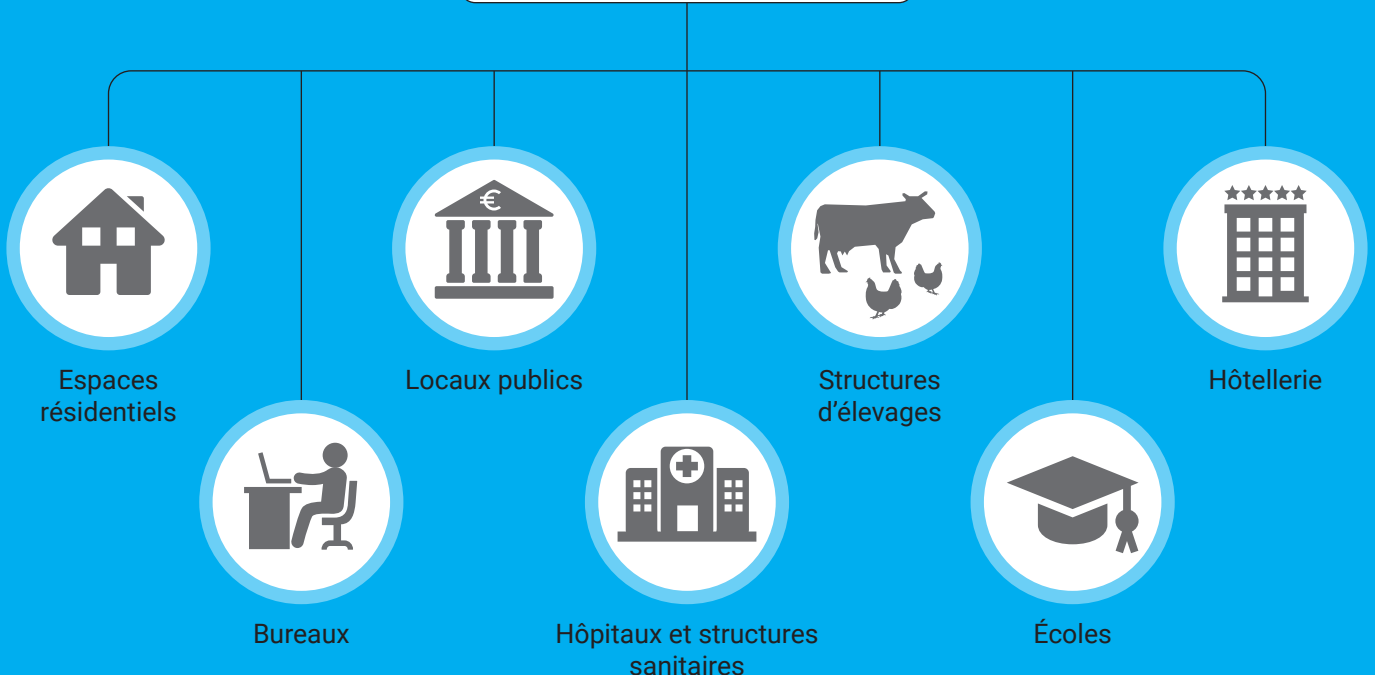



PROBLÈME

Il est de plus en plus important d'assurer l'hygiène dans les espaces communs de la vie quotidienne. Les méthodes actuellement utilisées pour assainir les espaces sont non seulement coûteuses et invasives, mais contraignent en plus les usagers à changer leurs habitudes.



SOLUTION

Linea Light Group présente Environment Care Lighting, une technologie mise au point et brevetée par l'Université de Glasgow qui, grâce à une longueur d'onde lumineuse de 405 nm, assainit les surfaces afin de prévenir les infections, garantissant ainsi le bien-être dans les espaces où elle est utilisée et parvenant à éliminer jusqu'à 70 % de la charge bactérienne. En effet, il a été constaté après un test de 10h que la réduction de la charge bactérienne était déjà de 35 %.

Environment Care Lighting utilise une LED à dominante bleue associée à une powerLED blanche, d'où une double fonctionnalité : l'éclairage en même temps que la désinfection des espaces. L'utilisation de LED à haut rendement chromatique permet d'éclairer les espaces en mettant en valeur leurs couleurs et leurs surfaces.



ÉCLAIRAGES VIVABLES

La technologie à 405 nm permet d'éviter l'utilisation coûteuse de technologies à UV, dont la fréquence comprise entre 240 et 260 nm ne permet pas un rayonnement permanent et qui altèrent significativement les propriétés organoleptiques des aliments, pouvant même leur nuire. Environment Care Lighting garantit le bien-être des personnes dans tous les espaces opérationnels où celles-ci passent la majeure partie de la journée.



OÙ ?

Les appareils de la gamme i-LèD utilisant la technologie Environment Care Lighting sont le Woofer et le Rollip, tous deux dotés d'un double système d'allumage qui permet de maintenir la fonction antibactérienne active même quand la lumière blanche est éteinte.

Ces systèmes d'éclairage, dont les matériaux ont été spécialement étudiés pour maximiser leur efficacité technologique, sont parfaits pour éclairer des espaces multifonctionnels, des zones de travail, des espaces de grande distribution, de locaux publics, des zones résidentielles et des structures d'élevage contrôlées.

WoofeR_R

Exemple d'utilisation sur volumes de 3 m x 2 m x h 2,7 m.
Surface d'efficacité 6 m².

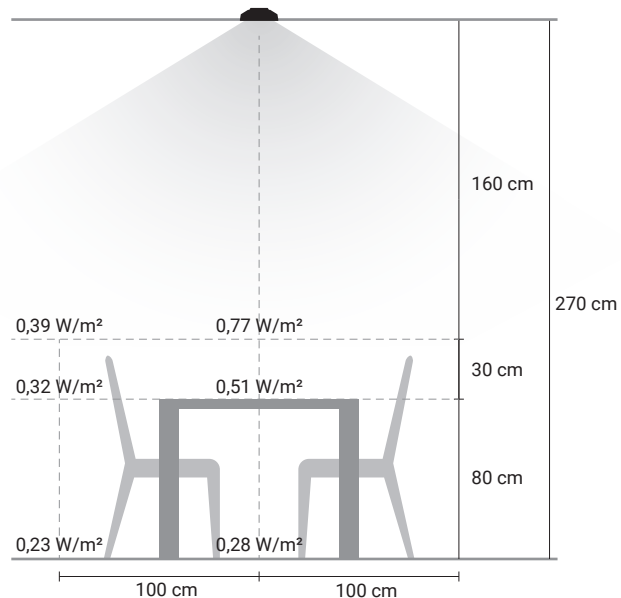
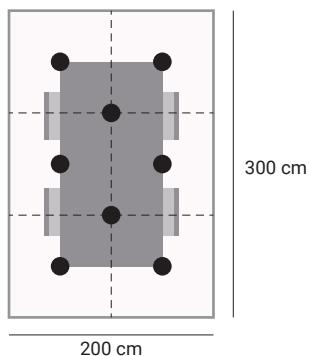

WoofeR_RX

Exemple d'utilisation sur volumes de 3 m x 3 m x h 2,7 m.
Surface d'efficacité 9 m².

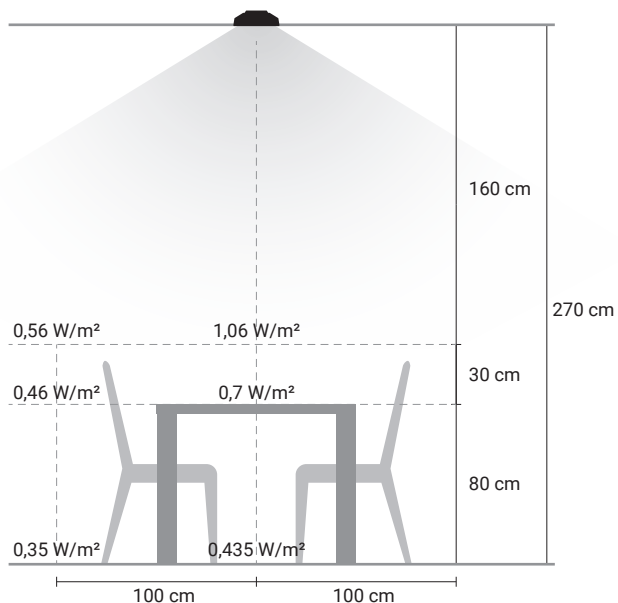
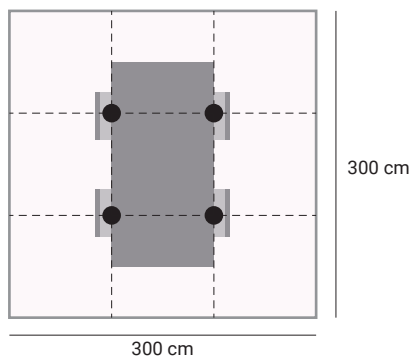

Rollip60_PC

Exemple d'utilisation sur volumes de 4 m x 3 m x h 2,7 m.
Surface d'efficacité 12 m².

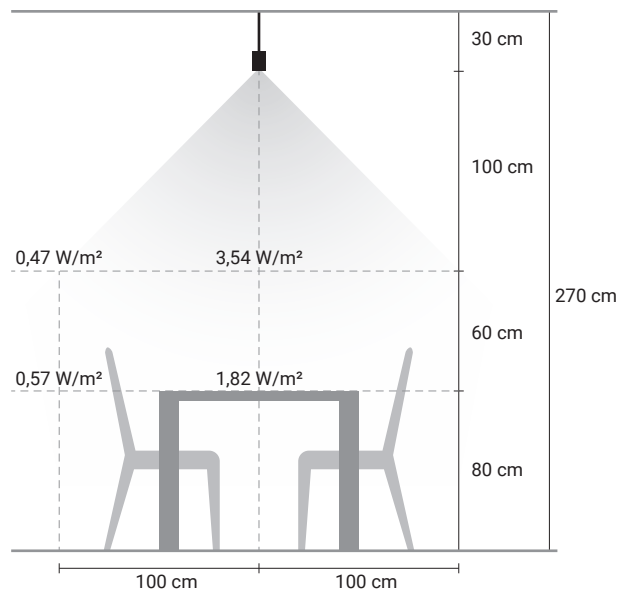
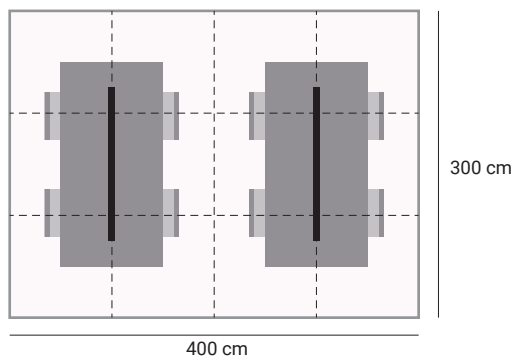

Woofler_R | Downlight | 100-240 V AC | topLED 18W DC - 20W AC | 405nm

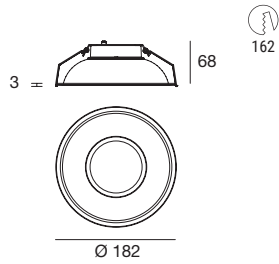

Efficiency - CRI 90	Cct	lm S - D	Optic
White 84023	T 3500	1387 - On req.	00 General

Woofler_RX | Downlight | 100-240 V AC | topLED 28W DC - 34W AC | 405 nm

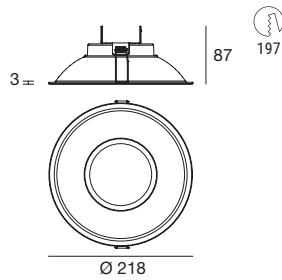

Efficiency - CRI 90	Cct	lm S - D	Optic
White 84024	T 3500	2100 - On req.	00 General

Rollip60_PC | Lines | 220-240 V | topLED | 405nm



1211 mm - 68 W - CRI 90	Cct	lm S - D	Optic
White 84079	T 3500	5385 - On Req	00 General
Black 84080			

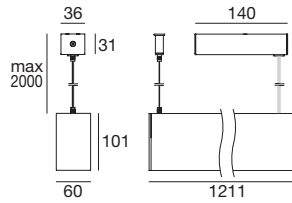

1511 mm - 85 W - CRI 90	Cct	lm S - D	Optic
White 84081	T 3500	7217 - On Req	00 General
Black 84082			

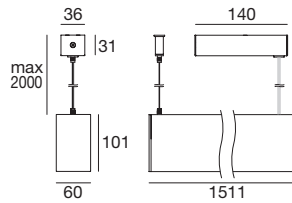

Emergency



emergency range index

Fled

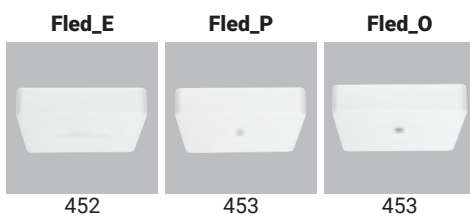

Onsight



Fled_E | Escape route | 220-240 V AC | powerLED 1,5 W DC - 1,7 W AC

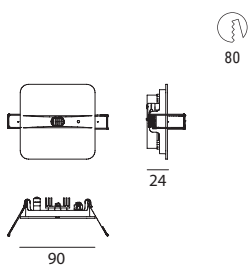

Standard	Cct	Im S - D	Optic
White 62504	6500	227 - On req.	Elliptic

UPS	Cct	Im S - D	Optic
White 64804	6500	227 - On req.	Elliptic

Boîtier d'encastrement Pag. 455

Fled_E | Escape route | 220-240 V AC | powerLED 1,5 W DC - 1,7 W AC

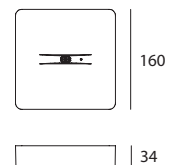

Standard	Cct	Im S - D	Optic
White 62514	6500	227 - On req.	Elliptic

UPS	Cct	Im S - D	Optic
White 64814	6500	227 - On req.	Elliptic

Fled_P | Escape route | 220-240 V AC | powerLED 1,5 W DC - 1,7 W AC

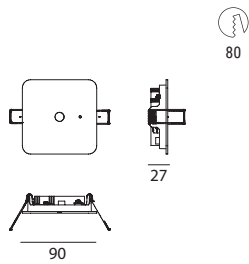

Standard	Cct	Im S - D	Optic
White 62524	6500	227 - On req.	General

UPS	Cct	Im S - D	Optic
White 64824	6500	227 - On req.	General

Boîtier d'encastrement Pag. 455

Fled_P | Escape route | 220-240 V AC | powerLED 1,5 W DC - 1,7 W AC

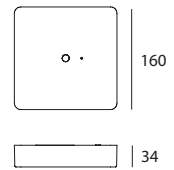

Standard	Cct	Im S - D	Optic
White 62534	6500	227 - On req.	General

UPS	Cct	Im S - D	Optic
White 64834	6500	227 - On req.	General

Fled_O | Escape route | 220-240 V AC | powerLED 1,5 W DC - 1,7 W AC

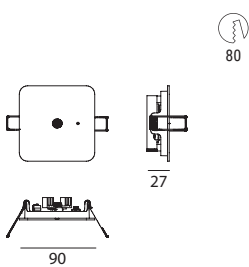

Standard	Cct	Im S - D	Optic
White 62544	6500	227 - On req.	General

UPS	Cct	Im S - D	Optic
White 64844	6500	227 - On req.	General

Boîtier d'encastrement Pag. 455

Fled_O | Escape route | 220-240 V AC | powerLED 1,5 W DC - 1,7 W AC

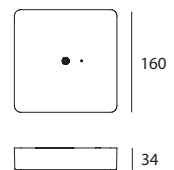

Standard	Cct	Im S - D	Optic
White 62554	6500	227 - On req.	General

UPS	Cct	Im S - D	Optic
White 64854	6500	227 - On req.	General

Onsight_W | Escape signal | 220-240 V AC | powerLED 1,5 W DC - 1,7 W AC

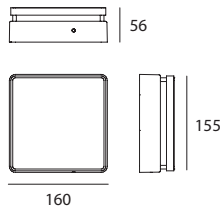

Standard	Cct	lm S - D	Optic
White 62500.L	6500	227 - On req.	General



UPS	Cct	lm S - D	Optic
White 62501.L	6500	227 - On req.	General

Standard	Cct	lm S - D	Optic
White 62500.R	6500	227 - On req.	General



UPS	Cct	lm S - D	Optic
White 62501.R	6500	227 - On req.	General

Standard	Cct	lm S - D	Optic
White 62500.U	6500	227 - On req.	General



UPS	Cct	lm S - D	Optic
White 62501.U	6500	227 - On req.	General

Onsight_SF | Escape signal | 220-240 V AC | powerLED 1,5 W DC - 1,7 W AC

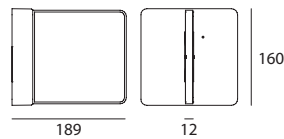

Standard	Cct	lm S - D	Optic
White 62520.L	6500	227 - On req.	General



UPS	Cct	lm S - D	Optic
White 62521.L	6500	227 - On req.	General

Standard	Cct	lm S - D	Optic
White 62520.R	6500	227 - On req.	General



UPS	Cct	lm S - D	Optic
White 62521.R	6500	227 - On req.	General

Standard	Cct	lm S - D	Optic
White 62520.U	6500	227 - On req.	General



UPS	Cct	lm S - D	Optic
White 62521.U	6500	227 - On req.	General

Onsight_W | Escape signal | 220-240 V AC | powerLED 4 W DC - 4,5 W AC

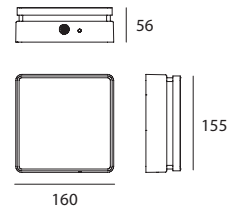

Standard	Cct	lm S - D	Optic
White 62510.L	6500	330 - On req.	General - 60°



UPS	Cct	lm S - D	Optic
White 62511.L	6500	330 - On req.	General - 60°

Standard	Cct	lm S - D	Optic
White 62510.R	6500	330 - On req.	General - 60°



UPS	Cct	lm S - D	Optic
White 62511.R	6500	330 - On req.	General - 60°

Standard	Cct	lm S - D	Optic
White 62510.U	6500	330 - On req.	General - 60°



UPS	Cct	lm S - D	Optic
White 62511.U	6500	330 - On req.	General - 60°

Onsight_SF | Escape signal | 220-240 V AC | powerLED 1,5 W DC - 1,7 W AC

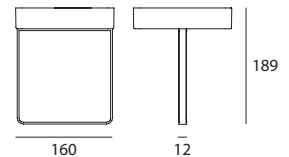

Standard	Cct	lm S - D	Optic
White 62530.U	6500	227 - On req.	General - 60°



UPS	Cct	lm S - D	Optic
White 62531.U	6500	227 - On req.	General - 60°

Standard	Cct	lm S - D	Optic
White 62530.S	6500	227 - On req.	General - 60°



UPS	Cct	lm S - D	Optic
White 62531.S	6500	227 - On req.	General - 60°

Onsight_RF | Escape signal | 220-240 V | powerLED 1,5 W DC - 1,7 W AC

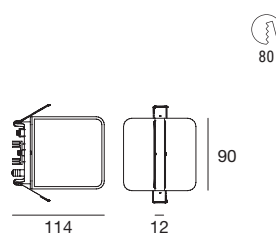

Standard	Cct	Im S - D	Optic
White 62540.L	6500	227 - On req.	General

UPS	Cct	Im S - D	Optic
White 62541.L	6500	227 - On req.	General

Standard	Cct	Im S - D	Optic
White 62540.R	6500	227 - On req.	General

UPS	Cct	Im S - D	Optic
White 62541.R	6500	227 - On req.	General

Standard	Cct	Im S - D	Optic
White 62540.U	6500	227 - On req.	General

UPS	Cct	Im S - D	Optic
White 62541.U	6500	227 - On req.	General

Onsight_RF | Escape signal | 220-240 V | powerLED 1,5 W DC - 1,7 W AC

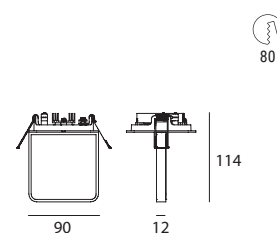

Standard	Cct	Im S - D	Optic
White 62550.U	6500	227 - On req.	General - 60°

UPS	Cct	Im S - D	Optic
White 62551.U	6500	227 - On req.	General - 60°

Standard	Cct	Im S - D	Optic
White 62550.S	6500	227 - On req.	General - 60°

UPS	Cct	Im S - D	Optic
White 62551.S	6500	227 - On req.	General - 60°

Boîtier d'encastrement Pag. 455

Onsight | Features

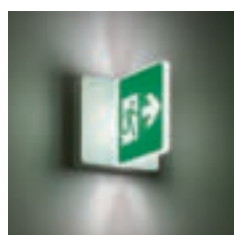
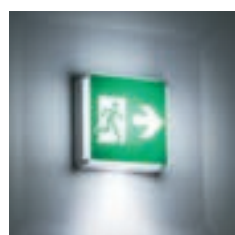

CORPS DE LA LAMPE	aluminium moulé sous pression
DIFFUSEUR	PMMA
SEGALE	image sérigraphiée UNI EN ISO 7010:2012
COULEUR DU SIGNAL	blanc/vert
ALIMENTATION (62500)	kit driver + batteries Ni-Cd, 7,2 V 1600 mAh
ALIMENTATION (62510)	kit driver + batteries Ni-Cd, 4,8 V, 1600 mAh
AUTONOMIE DE	1 h (temps de recharge 12 h)
FONCTIONNEMENT	jusqu'à 3 h (temps de recharge 24 h)
AUTOTEST	oui, avec LED de signalisation intégrée
IP	40
CONSOMMATION	1,7 W / 4,5 W

Boîtier d'encastrement



description	
89373	Boîtier d'encastrement
suitable for: Fled_E 1,5W / Fled_P 1,5W / Fled_O 1,5W Onsight_RF 1,5W	

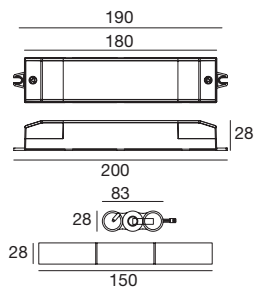

Commutable (on/off) en présence de tension de secteur via interrupteur sur l'entrée SL (ligne commutée). Réinitialisation automatique après remplacement de la batterie et/ou de la lampe LED. Système électronique de charge multi-niveau.
Fourni avec batterie 3000 mAh.

	range	output	input	eff.	PF	surge
99355	Universal	6-60V 40-400mA	220~240V AC	86%	0.5	4 kV

Frequency	50-60 Hz
Nominal input current	40 mA (30 A inrush current with cold start)
Outout voltage (without load)	6-60V
TA Operating temperature	-25 +50 °C
Max casing temperature TC	70 °C
Control interface	Switch Line, Rest mode
Protections	Overtemperature, overload, overvoltage, short-circuit, open circus
Charge current	200 mA
Emergency output current	400-40 mA
Emergency power	2,4W
Emergency output current	20 h

Reference norms	IEC 61347-2-7:2011, IEC 61347-2-7:2011/AMD1:2017, IEC 61347-1:2015, IEC 61347-1:2015/AMD1:2017, EN 61347-1:2015, EN 61347-2-7:2012+A1:2019, EN 55015:2013/A1:2015, EN61547:2009, EN 61000-3-2: 2014, EN 61000-3-3: 2013
------------------------	---

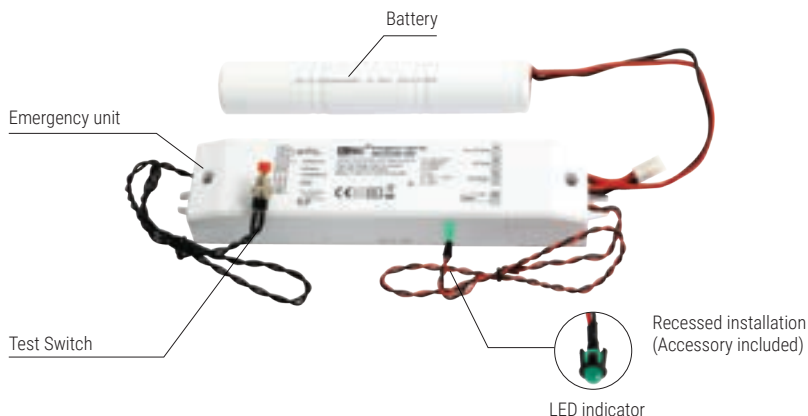

Unswitch Switch

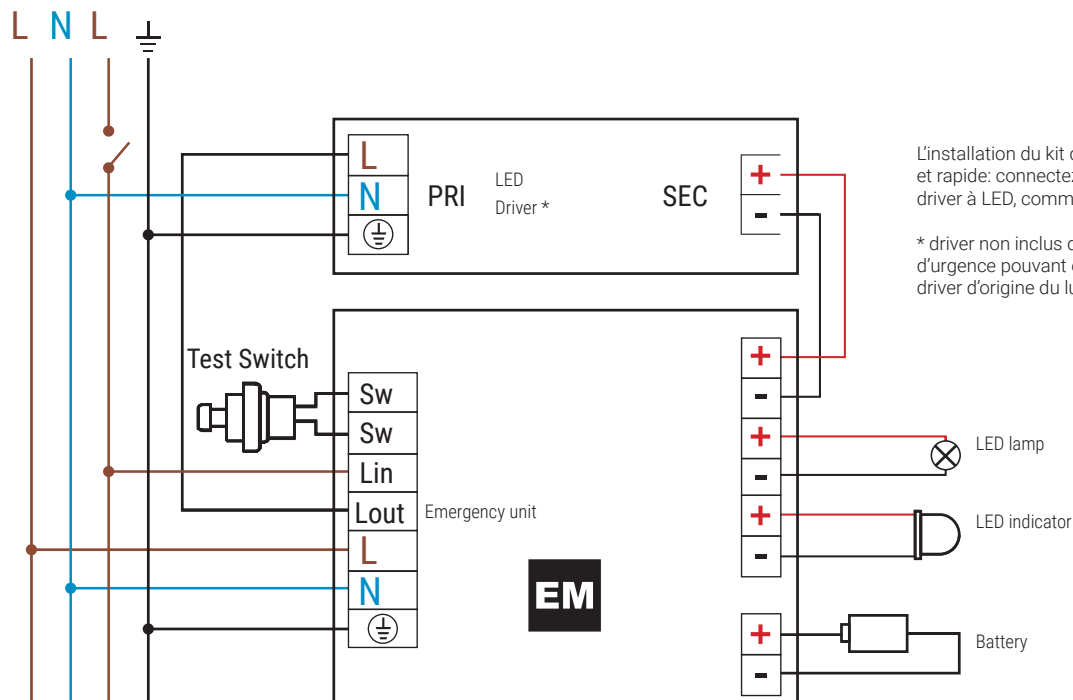

L'installation du kit d'urgence est simple et rapide: connectez l'unité de secours au driver à LED, comme indiqué sur le schéma.

* driver non inclus dans le kit d'urgence / kit d'urgence pouvant être connecté à tous les driver d'origine du luminaire à LED.

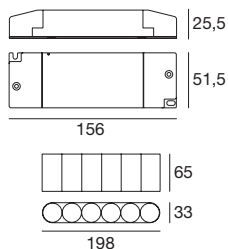

- Fonctionne uniquement en cas d'urgence
- Fonctionne en éclairage continu avec des alimentations électroniques, et électroniques avec gradateur.
- Version réglable avec commutateur DIP, pour alimentation à LED à courant constant ou pour modules LED à tension constante.
- Raccordables à des alimentations avec tension et courant maximaux en sortie de 90 V et 2 A
- Relais instantané en cas de coupure de réseau
- Batterie au NiCd haute température
- Indicateur de charge à LED avec câble FROR
- Dispositif de protection contre les décharges prolongées.
- Possibilités d'autodiagnostic avec le module externe MAT4 DALI.
- Dispositif de recharge avec isolation principale en mesure de recharger la batterie en mode normal, après l'épreuve mentionnée au point 22.3 de la norme CEI EN 61347-2-7:2007
- Fourni avec batterie 3000 mAh.

	range	output	input	PF
KIT0014	Universal C.C.	9-57V 350-60mA	220~240V AC	0.5
	Universal C.V.	24V 2000mA		

Frequency	50-60 Hz
Nominal input current	20 mA
Outout voltage (without load)	9-57V C.C. / 24V C.V.
TA Operating temperature	0 +50 °C
Max casing temperature TC	70 °C
Control interface	Switch Line, Rest mode

Protections	Overtemperature, overload, overvoltage, short-circuit, open circus
Emergency output current	350-60 mA C.C. / 2000mA C.V.
Emergency power	3,4W
Recharging time	24 h

Reference norms	EN61347-2-13, EN61347-2-7, EN61547, EN55015, EN60598-2-22, EN61000-3-2
-----------------	--

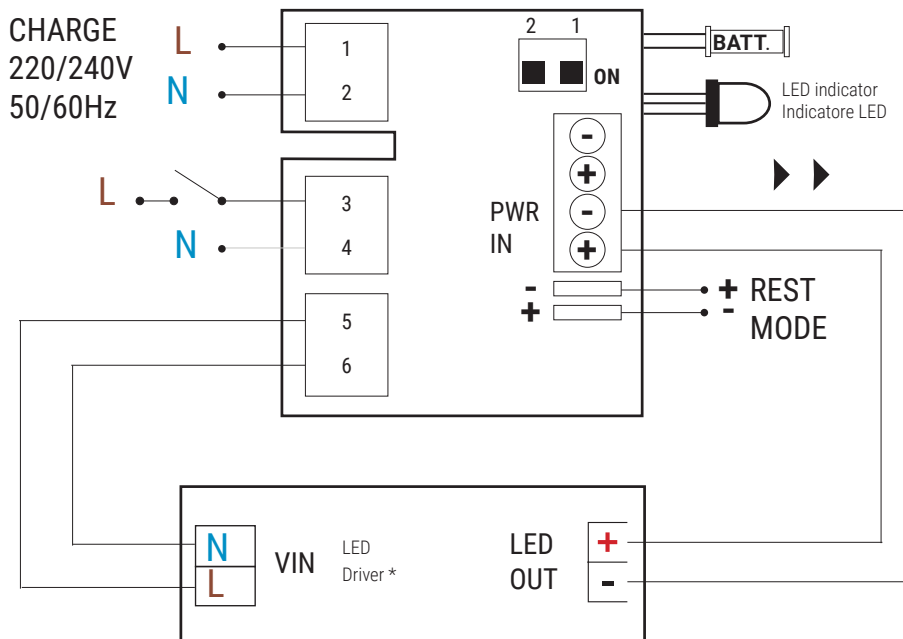

LED SOURCE

L'installation du kit d'urgence est simple et rapide: connectez l'unité de secours au driver à LED, comme indiqué sur le schéma.

* driver non inclus dans le kit d'urgence / kit d'urgence pouvant être connecté à tous les driver d'origine du luminaire à LED.



Ceiling lamps

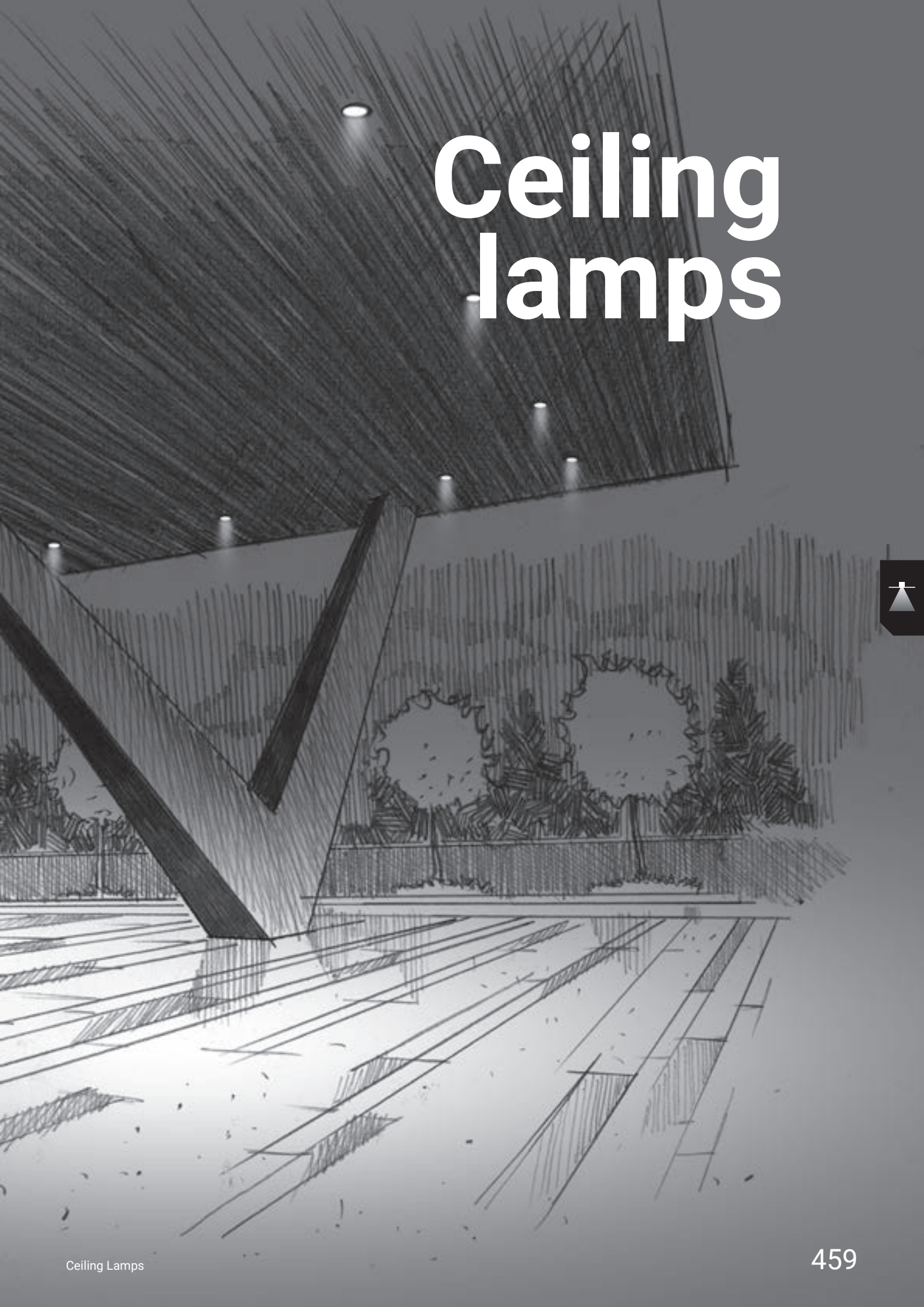

ceiling lamps range index

Guardian

Guardian



465

Guardian_J



465

Orma

Orma_C



472

Orma_CJ



472

Portik

Portik_R



478

Portik_Q



479









guardian

Matériaux

Corps en aluminium

Bride en aluminium anodisé

Guardian | Downlight | 198-264 V AC | powerLED 7,2 W DC - 8,5 W AC

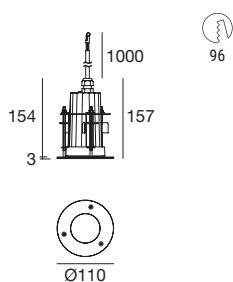

		Cct	lm S - D	Optic
White	81893	M 2700	709 - 568	15 Spot (17°)
Black	81916	W 3000	760 - 568	30 Flood (26°)
Grey	81838	N 4000	821 - 613	60 W.Flood (51°)
				07 Asymm. -

		Cct	lm S - D	Optic
White	81894	M 2700	709 - 453	15 Spot (14°)
Black	81917	W 3000	760 - 453	30 Flood (24°)
Grey	81839	N 4000	821 - 489	60 Flood (42°)

Boîtier d'encastrement Pag. 467

Guardian_J | Downlight | 198-264 V AC | powerLED 7,2 W DC - 8,5 W AC

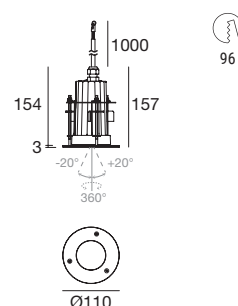

		Cct	lm S - D	Optic
White	81895	M 2700	709 - 558	20 Spot -
Black	81918	W 3000	760 - 558	30 Flood (30°)
Grey	81840	N 4000	821 - 603	60 W.Flood (60°)

Boîtier d'encastrement Pag. 467

81909W07

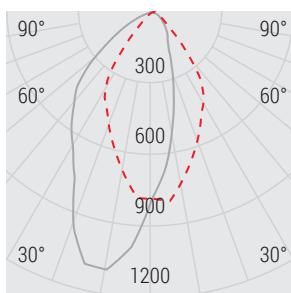

Courbe photométrique

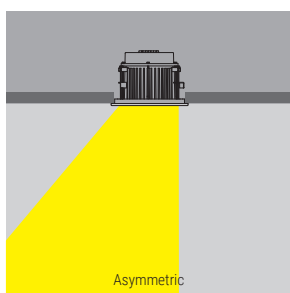

Faisceau lumineux

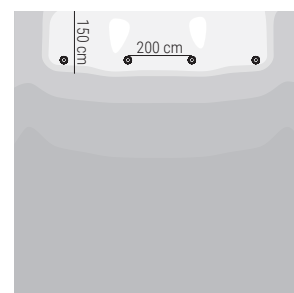

Planimétrie

Guardian | Downlight | 198-264 V AC | arrayLED 12,6 W DC - 14,1 W AC

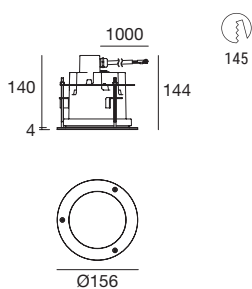

	Cct	Im S - D	Optic
White 81896	M 2700	1724 - 1098	15 Spot (14°)
Black 81919	W 3000	1724 - 1144	30 Flood (33°)
Grey 81841	N 4000	1854 - 1208	60 W.Flood (64°)

	Cct	Im S - D	Optic
White 81899	M 2700	1683 - 769	07 Asymm. -
Black 81922	W 3000	1808 - 800	
Grey 81844	N 4000	1949 - 846	

	HC	Cct	Im S - D	Optic
White 81897	M 2700	1724 - 668	15 Spot (14°)	
Black 81920	W 3000	1724 - 696	30 Flood (29°)	
Grey 81842	N 4000	1854 - 735	60 W.Flood (49°)	

Boîtier d'encastrement Pag. 467

Guardian_J | Downlight | 198-264 V AC | arrayLED 12,6 W DC - 14,1 W AC

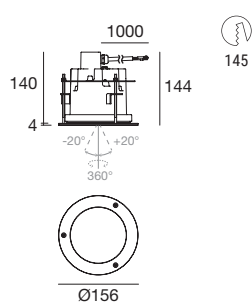

	Cct	Im S - D	Optic
White 81904	M 2700	1724 - 978	15 Spot (16°)
Black 81927	W 3000	1724 - 1020	35 Flood (30°)
Grey 81849	N 4000	1854 - 1077	45 W.Flood (46°)

Boîtier d'encastrement Pag. 467

Guardian | Downlight | 198-264 V AC | arrayLED 12,6 W DC - 14,1 W AC

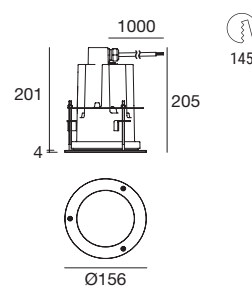

DALI	Cct	Im S - D	Optic
White 81900	M 2700	1724 - 1098	15 Spot (14°)
Black 81923	W 3000	1724 - 1144	30 Flood (33°)
Grey 81845	N 4000	1854 - 1208	60 W.Flood (64°)

DALI	Cct	Im S - D	Optic
White 81903	M 2700	1683 - 769	07 Asymm. -
Black 81926	W 3000	1808 - 800	
Grey 81848	N 4000	1949 - 846	

DALI	HC	Cct	Im S - D	Optic
White 81901	M 2700	1724 - 668	15 Spot (14°)	
Black 81924	W 3000	1724 - 696	30 Flood (29°)	
Grey 81846	N 4000	1854 - 735	60 W.Flood (49°)	

Boîtier d'encastrement Pag. 467

Guardian_J | Downlight | 198-264 V AC | arrayLED 12,6 W DC - 14,1 W AC

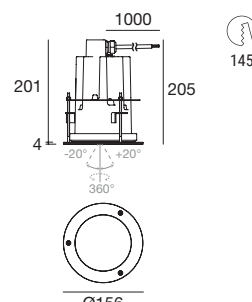
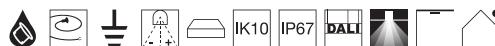

DALI	Cct	Im S - D	Optic
White 81905	M 2700	1724 - 978	15 Spot (16°)
Black 81928	W 3000	1724 - 1020	35 Flood (30°)
Grey 81850	N 4000	1854 - 1077	45 W.Flood (46°)

Boîtier d'encastrement Pag. 467

Guardian | Downlight | 198-264 V AC | arrayLED 30 W DC - 33,6 W AC

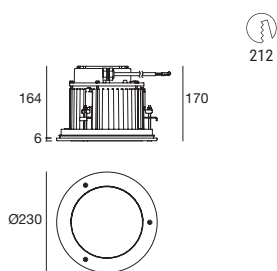

	Cct	Im S - D	Optic
White 81906	M 2700	4088 - 3159	15 Spot (18°)
Black 81929	W 3000	4372 - 3293	30 Flood (31°)
Grey 81867	N 4000	4702 - 3475	60 W.Flood (57°)

	Cct	Im S - D	Optic
White 81909	M 2700	3167 - 1408	07 Asymm. -
Black 81932	W 3000	3401 - 1467	
Grey 81870	N 4000	3667 - 1548	

	HC	Cct	Im S - D	Optic
White 81907	M 2700	4088 - 1743	15 Spot (18°)	
Black 81930	W 3000	4372 - 1816	30 Flood (28°)	
Grey 81868	N 4000	4702 - 1918	60 W.Flood (40°)	

Boîtier d'encastrement Pag. 467

Guardian_J | Downlight | 198-264 V AC | arrayLED 30 W DC - 33,6 W AC

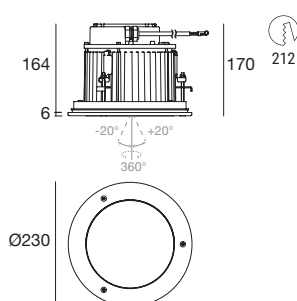

	Cct	Im S - D	Optic
White 81914	M 2700	4088 - 2945	15 Spot (18°)
Black 81937	W 3000	4372 - 3068	35 Flood (34°)
Grey 81875	N 4000	4702 - 3240	45 W.Flood (58°)

Boîtier d'encastrement Pag. 467

Boîtier encastrable pour installation sur brique ou béton

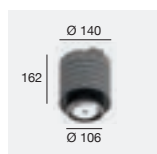

description	
99673	Boîtier d'encastrement
suitable for: Guardian 7,2W / Guardian_J 7,2W	



description	
83048	Boîtier d'encastrement
suitable for: Guardian DALI 12,6W / Guardian_J DALI 12,6W	

Guardian | Downlight | 198-264 V AC | arrayLED 30 W DC - 33,6 W AC

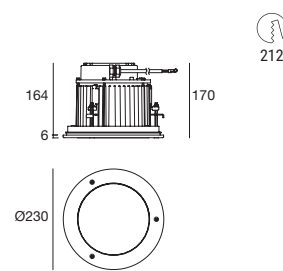

DALI	Cct	Im S - D	Optic
White 81910	M 2700	4088 - 3159	15 Spot (18°)
Black 81933	W 3000	4372 - 3293	30 Flood (31°)
Grey 81871	N 4000	4702 - On req	60 W.Flood (57°)

DALI	Cct	Im S - D	Optic
White 81913	M 2700	3167 - 1408	07 Asymm. -
Black 81936	W 3000	3401 - 1467	
Grey 81874	N 4000	3667 - 1548	

DALI	HC	Cct	Im S - D	Optic
White 81911	M 2700	4088 - 1743	15 Spot (18°)	
Black 81934	W 3000	4372 - 1816	30 Flood (28°)	
Grey 81872	N 4000	4702 - 1918	60 W.Flood (40°)	

Boîtier d'encastrement Pag. 467

Guardian_J | Downlight | 198-264 V AC | arrayLED 30 W DC - 33,6 W AC

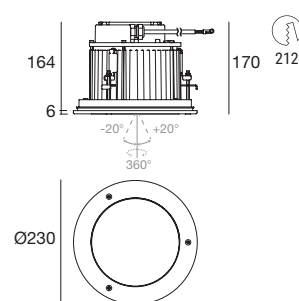
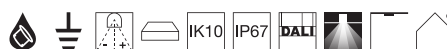

DALI	Cct	Im S - D	Optic
White 81915	M 2700	4088 - 2945	15 Spot (18°)
Black 81938	W 3000	4372 - 3068	35 Flood (34°)
Grey 81876	N 4000	4702 - 3240	45 W.Flood (58°)

Boîtier d'encastrement Pag. 467



description	
99674	Boîtier d'encastrement
suitable for: Guardian 12,6W / Guardian_J 12,6W	

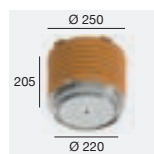

description	
99675	Boîtier d'encastrement
suitable for: Guardian 30W / Guardian DALI 30W / Guardian_J 30W / Guardian_J DALI 30W	



orma

Matériaux

Corps en aluminium

Bride en inox AISI 316L



orma_c range



	_C Ceiling	_CJ Ceiling Adjustable
4W/5W	64 mm	64 mm
8W/9W	97 mm	97 mm
12W/13W	138 mm	138 mm
Accessories	HC DL	HC
Finish	Steel Alu	Steel Alu
CRI 80	2700K - 3000K - 4000K	2700K - 3000K - 4000K
Optics	Spot - Flood - Wide Flood Elliptic	Spot - Flood Wide Flood
Driver	On/Off - 1/10 V - DALI	On/Off - 1/10 V - DALI
Current	C.C. C.V.	C.C. C.V.
	55 mm 86 mm 127 mm	55 mm 86 mm 127 mm

Faible encombrement

Un downlight peu encombrant, de 46 à 50 mm seulement, avec une bride réduite et des optiques conçus pour loger, à l'intérieur du corps, une solution intelligente qui facilite l'installation du produit.

10
9
8
7
6
5
4
3
2
1
0



Confort visuel

En fonction de la position d'installation, il est possible d'optimiser l'émission lumineuse à l'aide de l'accessoire dédié. Le filtre en nid d'abeilles masque la lumière secondaire et réduit l'éblouissement direct, tout en maintenant une émission diffuse de qualité inaltérée. Dans le cas d'un éclairage rasant, le filtre darklight permet de couper le faisceau pour ne conserver que la partie utile de celui-ci, à savoir celle qui est uniquement dirigée vers la portion de mur à éclairer, limitant ainsi l'éblouissement direct y compris à proximité de la source.



Orma



Orma
+ honeycomb



Orma
+ darklight

Largeur de gamme

Une famille complète, avec différentes solutions d'éclairage au choix : trois optiques, spot, medium flood et flood. Disponible en trois tailles, avec versions à courant continu ou alternatif. D'autre part, la gamme de downlights Orma_C comprend les versions orientables C.J, s'orientant simplement en agissant sur la vis dédiée à l'aide d'un tournevis plat, sans avoir à ouvrir le corps de la lampe.



± 25° (8 W - 13 W)
± 20° (4 W)

Orma_C | Downlight | powerLED

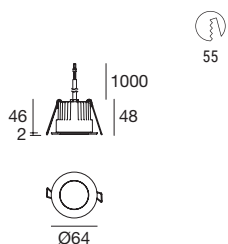

C.C. - 4W DC 350 mA	Cct	Im S - D	Optic
Steel Alu 81223	M 2700	490 - 270	15 Spot (22°)
	W 3000	490 - 270	30 Flood (29°)
	N 4000	529 - 292	60 W.Flood (48°)
			25 Elliptic -

HC 4W 350 DC mA	Cct	Im S - D	Optic
Steel Alu 81224	M 2700	490 - 186	15 Spot (20°)
	W 3000	490 - 186	30 Flood (25°)
	N 4000	529 - 201	60 Flood (37°)

DL 4W DC 350 mA	Cct	Im S - D	Optic
Steel Alu 81225	M 2700	490 - 193	15 Spot (22°)
	W 3000	490 - 193	30 Flood (30°)
	N 4000	529 - 208	60 W.Flood (55°)

Électronique

89421	99183	83100
ON/OFF 1 art. p 65 x l 74 x h 27	ON/OFF 1 - 2 art. p 80 x l 100 x h 31	DALI 1 - 4 art. p 54 x l 121 x h 26

C.V. - 5W DC 24 V DC	Cct	Im S - D	Optic
Steel Alu 81226	M 2700	490 - 270	15 Spot (22°)
	W 3000	490 - 270	30 Flood (29°)
	N 4000	529 - 292	60 W.Flood (48°)
			25 Elliptic (39°)

HC C.V. - 5W DC 24 V DC	Cct	Im S - D	Optic
Steel Alu 81227	M 2700	490 - 186	15 Spot (20°)
	W 3000	490 - 186	30 Flood (25°)
	N 4000	529 - 201	60 Flood (37°)

DL C.V. - 5W DC 24 V DC	Cct	Im S - D	Optic
Steel Alu 81228	M 2700	490 - 193	15 Spot (22°)
	W 3000	490 - 193	30 Flood (30°)
	N 4000	529 - 208	60 W.Flood (55°)

Électronique

89488	89179	89359	99332	99722
ON/OFF 1 - 2 art. p 80 x l 100 x h 31	ON/OFF 1 - 4 art. p 92 x l 117 x h 38	ON/OFF 1 - 9 art. p 115 x l 140 x h 50	0/1-10V 1 - 29 art. p 150 x l 160 x h 35	DALI 1 - 23 art. p 191 x l 63 x h 38

Version C.V. avec convertisseur intégré dans le câble



RTG 81223W30 / 81223W60

Orma_CJ | Downlight | powerLED

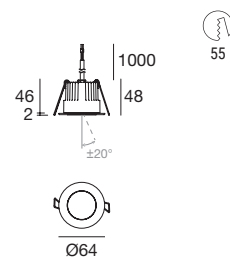

C.C. - 4W DC 350 mA	Cct	Im S - D	Optic
Steel Alu 81241	M 2700	490 - 270	15 Spot (22°)
	W 3000	490 - 270	30 Flood (29°)
	N 4000	529 - 292	60 W.Flood (48°)

Électronique

89421	99183	83100
ON/OFF 1 art. p 65 x l 74 x h 27	ON/OFF 1 - 2 art. p 80 x l 100 x h 31	DALI 1 - 4 art. p 54 x l 121 x h 26

C.V. - 5W DC 24 V DC	Cct	Im S - D	Optic
Steel Alu 81242	M 2700	490 - 270	15 Spot (22°)
	W 3000	490 - 270	30 Flood (29°)
	N 4000	529 - 292	60 W.Flood (48°)

Électronique

89488	89179	89359	99332	99722
ON/OFF 1 - 2 art. p 80 x l 100 x h 31	ON/OFF 1 - 4 art. p 92 x l 117 x h 38	ON/OFF 1 - 9 art. p 115 x l 140 x h 50	0/1-10V 1 - 29 art. p 150 x l 160 x h 35	DALI 1 - 23 art. p 191 x l 63 x h 38

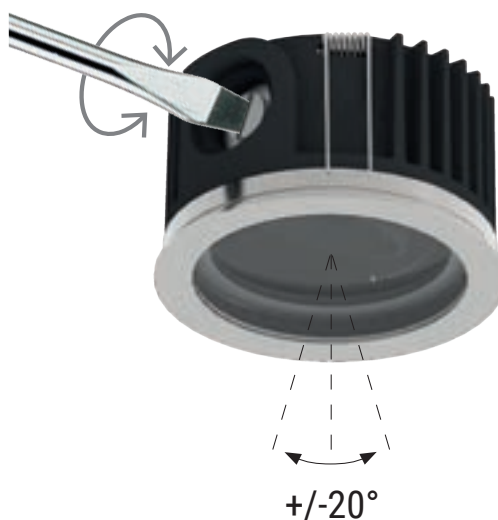

Version C.V. avec convertisseur intégré dans le câble



Orma_C | Downlight | arrayLED

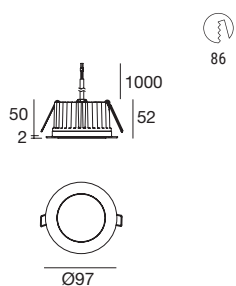

C.C. - 8W DC 220 mA	Cct	lm S - D	Optic
Steel Alu 81229	M 2700	1088 - 858	15 Spot (15°)
	W 3000	1088 - 894	30 Flood (31°)
	N 4000	1173 - 944	60 W.Flood (61°)

HC C.C. - 8W DC 220 mA	Cct	lm S - D	Optic
Steel Alu 81230	M 2700	1088 - 619	15 Spot (15°)
	W 3000	1088 - 645	30 Flood (27°)
	N 4000	1173 - 681	60 W.Flood (49°)

DL C.C. - 8W DC 220 mA	Cct	lm S - D	Optic
Steel Alu 81231	M 2700	1088 - 575	15 Spot (16°)
	W 3000	1088 - 599	30 Flood (29°)
	N 4000	1173 - 633	60 W.Flood (53°)

Électronique

99342 83154

ON/OFF DALI
1 art. 1 art.
p 80 x l 100 x h 31 p 54 x l 121 x h 26

C.V. - 9W DC 24 V DC	Cct	lm S - D	Optic
Steel Alu 81232	M 2700	1209 - 954	15 Spot (15°)
	W 3000	1209 - 996	30 Flood (31°)
	N 4000	1303 - 1052	60 W.Flood (61°)

HC C.V. - 9W DC 24 V DC	Cct	lm S - D	Optic
Steel Alu 81233	M 2700	1209 - 687	15 Spot (15°)
	W 3000	1209 - 716	30 Flood (27°)
	N 4000	1303 - 756	60 W.Flood (49°)

DL C.V. - 9W DC 24 V DC	Cct	lm S - D	Optic
Steel Alu 81234	M 2700	1209 - 639	15 Spot (16°)
	W 3000	1209 - 666	30 Flood (29°)
	N 4000	1303 - 703	60 W.Flood (53°)

Électronique

89179 89359 99331 99332 99722

ON/OFF ON/OFF ON/OFF 0/1-10V DALI
1-2 art. 1-5 art. 1-15 art. 1-15 art. 1-12 art.
p 92 x l 117 x h 38 p 115 x l 140 x h 50 p 150 x l 60 x h 35 p 150 x l 60 x h 35 p 191 x l 63 x h 38

Version C.V. avec convertisseur intégré dans le corps de la lampe

RTG 81229W30 / 81229W60

Orma_CJ | Downlight | arrayLED

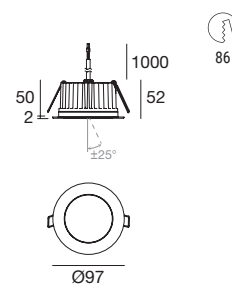
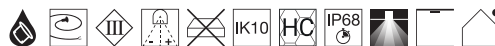

C.C. - 8W DC 220 mA	Cct	lm S - D	Optic
Steel Alu 81243	M 2700	1088 - 858	15 Spot (15°)
	W 3000	1088 - 894	30 Flood (31°)
	N 4000	1173 - 944	60 W.Flood (61°)

HC C.C. - 8W DC 220 mA	Cct	lm S - D	Optic
Steel Alu 82452	M 2700	1088 - 858	15 Spot -
	W 3000	1088 - 894	30 Flood -
	N 4000	1173 - 944	60 W.Flood -

Électronique

99342 83154

ON/OFF DALI
1 art. 1 art.
p 80 x l 100 x h 31 p 54 x l 121 x h 26

C.V. - 9W DC 24 V DC	Cct	lm S - D	Optic
Steel Alu 81244	M 2700	1209 - 954	15 Spot (15°)
	W 3000	1209 - 996	30 Flood (31°)
	N 4000	1303 - 1052	60 W.Flood (61°)

HC C.V. - 9W DC 24 V DC	Cct	lm S - D	Optic
Steel Alu 82453	M 2700	1209 - 954	15 Spot -
	W 3000	1209 - 996	30 Flood -
	N 4000	1303 - 1052	60 W.Flood -

Électronique

89179 89359 99331 99332 99722

ON/OFF ON/OFF ON/OFF 0/1-10V DALI
1-2 art. 1-5 art. 1-15 art. 1-15 art. 1-12 art.
p 92 x l 117 x h 38 p 115 x l 140 x h 50 p 150 x l 60 x h 35 p 150 x l 60 x h 35 p 191 x l 63 x h 38

Version C.V. avec convertisseur intégré dans le corps de la lampe

Orma_C | Downlight | arrayLED

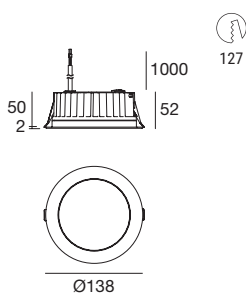

C.C. - 12W DC 350 mA		Cct	lm S - D	Optic
Steel/Alu	81235	M 2700	1724 - 1379	15 Spot (12°)
		W 3000	1724 - 1379	30 Flood (26°)
		N 4000	1854 - 1485	60 W.Flood (51°)

HC C.C. - 12W DC 350 mA		Cct	lm S - D	Optic
Steel/Alu	81236	M 2700	1724 - 981	15 Spot (12°)
		W 3000	1724 - 981	30 Flood (26°)
		N 4000	1854 - 1055	60 W.Flood (51°)

DL C.C. - 12W DC 350 mA		Cct	lm S - D	Optic
Steel/Alu	81237	M 2700	1724 - 1094	15 Spot (12°)
		W 3000	1724 - 1094	30 Flood (26°)
		N 4000	1854 - 1178	60 W.Flood (51°)

Électronique

99183 **83100**

ON/OFF DALI
1 art. 1 art.
p 80 x l 100 x h 31 p 54 x l 121 x h 26

C.V. - 13 W DC 24 V DC		Cct	lm S - D	Optic
Steel/Alu	81238	M 2700	1724 - 1379	15 Spot (12°)
		W 3000	1724 - 1379	30 Flood (26°)
		N 4000	1854 - 1485	60 W.Flood (51°)

HC C.V. - 13 W DC 24 V DC		Cct	lm S - D	Optic
Steel/Alu	81239	M 2700	1724 - 981	15 Spot (12°)
		W 3000	1724 - 981	30 Flood (26°)
		N 4000	1854 - 1055	60 W.Flood (51°)

DL C.V. - 13 W DC 24 V DC		Cct	lm S - D	Optic
Steel/Alu	81240	M 2700	1724 - 1094	15 Spot (12°)
		W 3000	1724 - 1094	30 Flood (26°)
		N 4000	1854 - 1178	60 W.Flood (51°)

Électronique

89179 **89359** **99331** **99332** **99722**

ON/OFF ON/OFF ON/OFF 0/1-10V DALI
1 art. 1-3 art. 1-10 art. 1-10 art. 1-8 art.
p 92 x l 117 x h 38 p 115 x l 140 x h 50 p 150 x l 60 x h 35 p 150 x l 60 x h 35 p 191 x l 63 x h 38

Version C.V. avec convertisseur intégré dans le corps de la lampe

Orma_CJ | Downlight | arrayLED

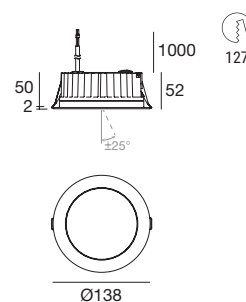
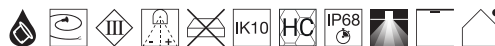

C.C. - 12W DC 350 mA		Cct	lm S - D	Optic
Steel/Alu	81245	M 2700	1724 - 1317	15 Spot (12°)
		W 3000	1724 - 1317	30 Flood (26°)
		N 4000	1854 - 1417	60 W.Flood (51°)

HC C.C. - 12W DC 350 mA		Cct	lm S - D	Optic
Steel/Alu	82454	M 2700	1724 - 1317	15 Spot -
		W 3000	1724 - 1317	30 Flood -
		N 4000	1854 - 1417	60 W.Flood -

Électronique

99183 **83100**

ON/OFF DALI
1 art. 1 art.
p 80 x l 100 x h 31 p 54 x l 121 x h 26

C.V. - 13 W DC 24 V DC		Cct	lm S - D	Optic
Steel/Alu	81246	M 2700	1724 - 1317	15 Spot (12°)
		W 3000	1724 - 1317	30 Flood (26°)
		N 4000	1854v1417	60 W.Flood (51°)

HC C.V. - 13 W DC 24 V DC		Cct	lm S - D	Optic
Steel/Alu	82455	M 2700	1724 - 1317	15 Spot -
		W 3000	1724 - 1317	30 Flood -
		N 4000	1854 - 1417	60 W.Flood -

Électronique

89179 **89359** **99331** **99332** **99722**

ON/OFF ON/OFF ON/OFF 0/1-10V DALI
1 art. 1-3 art. 1-10 art. 1-10 art. 1-8 art.
p 92 x l 117 x h 38 p 115 x l 140 x h 50 p 150 x l 60 x h 35 p 150 x l 60 x h 35 p 191 x l 63 x h 38

Version C.V. avec convertisseur intégré dans le corps de la lampe





portik

Matériaux
Corps en aluminium



Portik_R | Ceiling luminaires | 198-264 V AC | arrayLED 6,5 W DC - 7,5 W AC

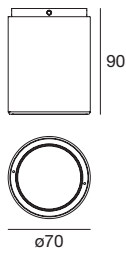

		Cct	lm S - D	Optic
White	81851	M 2700	770 - 646	15 Spot (14°)
Black	81852	W 3000	770 - 646	30 Flood (39°)
Grey	81853	N 4000	831 - 697	60 W.Flood (67°)
DarkBrown	81854			

Portik_R | Ceiling luminaires | arrayLED 6,5 W DC 700mA



		Cct	lm S - D	Optic
White	83685	M 2700	770 - On req.	15 Spot -
Black	83686	W 3000	770 - On req.	30 Flood -
Grey	83687	N 4000	831 - On req.	60 W.Flood -
DarkBrown	83688			

Électronique

89420	99179	99186	83102
ON/OFF 1 art. p 66 x l 74 x h 27	ON/OFF 2 - 3 art. p 80 x l 100 x h 31	ON/OFF 3 - 6 art. p 92 x l 117 x h 38	DALI 1 - 7 art. p 54 x l 122 x h 26

RTG 81851W60 / 83685M30 / 83686M30

Portik_R | Ceiling luminaires | 198-264 V AC | arrayLED

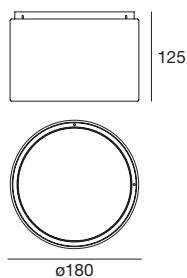

25 W DC - 28 W AC		Cct	lm S - D	Optic
White	81877	M 2700	3606 - 2578	15 Spot (18°)
Black	81878	W 3000	3758 - 2687	30 Flood (26°)
Grey	81879	N 4000	3967 - 2837	60 W.Flood (54°)
DarkBrown	81880			

34 W DC - 39 W AC

		Cct	lm S - D	Optic
White	81371	M 2700	5232 - 3342	15 Spot (18°)
Black	81372	W 3000	5453 - 3484	30 Flood (26°)
Grey	81373	N 4000	5756 - 3677	60 W.Flood (54°)
DarkBrown	81374			

Portik_R | Ceiling luminaires | 198-264 V AC | arrayLED 12,5 W DC - 14 W AC

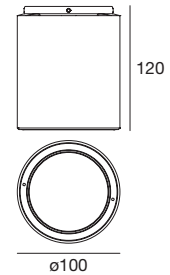

		Cct	lm S - D	Optic
White	81855	M 2700	1724 - 1231	15 Spot (12°)
Black	81856	W 3000	1724 - 1231	30 Flood (31°)
Grey	81857	N 4000	1854 - 1324	60 W.Flood (62°)
DarkBrown	81858			

Portik_R | Ceiling luminaires | arrayLED 12,5 W DC 350mA



		Cct	lm S - D	Optic
White	83693	M 2700	1724 - On req.	15 Spot -
Black	83694	W 3000	1724 - On req.	30 Flood -
Grey	83695	N 4000	1854 - On req.	60 W.Flood -
DarkBrown	83696			

Électronique

99183	83100
ON/OFF 1 art. p 80 x l 100 x h 31	DALI 1 art. p 54 x l 121 x h 26

RTG 81855W60

Portik_R | Ceiling luminaires | 198-264 V AC | arrayLED 33 W DC - 36 W AC

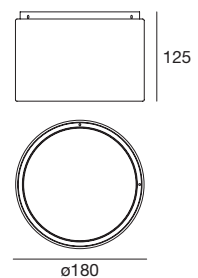

DALI		Cct	lm S - D	Optic
White	81885	M 2700	4469 - 3197	15 Spot (18°)
Black	81886	W 3000	4656 - 3333	30 Flood (26°)
Grey	81887	N 4000	4915 - 3518	60 W.Flood (54°)
DarkBrown	81888			

Portik_Q | Up-Light | 198-264 V AC | arrayLED 6,5 W DC - 7,5 W AC

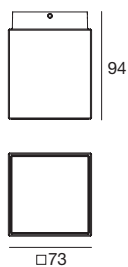

	Cct	lm S - D	Optic
White 80618	M 2700	770 - 557	15 Spot (15°)
Black 80619	W 3000	770 - 597	30 Flood (37°)
Grey 80620	N 4000	831 - 645	60 W.Flood (62°)
DarkBrown 80621			

Portik_Q | Ceiling luminaires | arrayLED 6,5 W DC 700mA



	Cct	lm S - D	Optic
White 83689	M 2700	770 - On req.	15 Spot -
Black 83690	W 3000	770 - On req.	30 Flood -
Grey 83691	N 4000	831 - On req.	60 W.Flood -
DarkBrown 83692			

Électronique

89420	99179	99186	83102
ON/OFF 1 art. p 66 x l 74 x h 27	ON/OFF 2 - 3 art. p 80 x l 100 x h 31	ON/OFF 3 - 6 art. p 92 x l 117 x h 38	DALI 1 - 7 art. p 54 x l 122 x h 26

Portik_Q | Ceiling luminaires | 198-264 V AC | arrayLED 12,5 W DC - 14 W AC

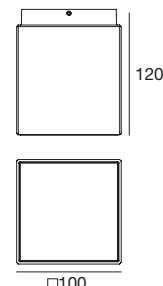

	Cct	lm S - D	Optic
White 80622	M 2700	1724 - 1231	15 Spot (12°)
Black 80623	W 3000	1724 - 1231	30 Flood (31°)
Grey 80624	N 4000	1854 - 1324	60 W.Flood (62°)
DarkBrown 80625			

Portik_Q | Ceiling luminaires | arrayLED 12,5 W DC 350mA



	Cct	lm S - D	Optic
White 83697	M 2700	1724 - On req.	15 Spot -
Black 83698	W 3000	1724 - On req.	30 Flood -
Grey 83699	N 4000	1854 - On req.	60 W.Flood -
DarkBrown 83700			

Électronique

99183	83100
ON/OFF 1 art. p 80 x l 100 x h 31	DALI 1 art. p 54 x l 121 x h 26

Portik_Q | Ceiling luminaires | 198-264 V AC | arrayLED

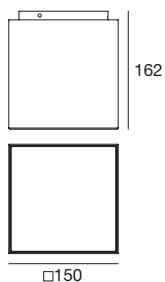
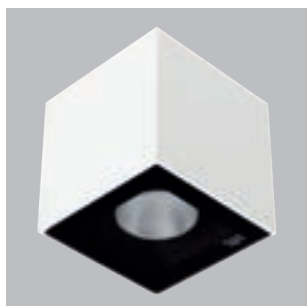

25 W DC - 28 W AC	Cct	lm S - D	Optic
White 81881	M 2700	3606 - 2580	15 Spot (17°)
Black 81882	W 3000	3758 - 2689	30 Flood (26°)
Grey 81883	N 4000	3967 - 2839	60 W.Flood (46°)
DarkBrown 81884			

34 W DC - 39 W AC	Cct	lm S - D	Optic
White 81375	M 2700	5232 - 3343	15 Spot (17°)
Black 81376	W 3000	5453 - 3485	30 Flood (26°)
Grey 81377	N 4000	5756 - 3678	60 W.Flood (46°)
DarkBrown 81378			

Portik_Q | Ceiling luminaires | 198-264 V AC | arrayLED 33 W DC - 36 W AC

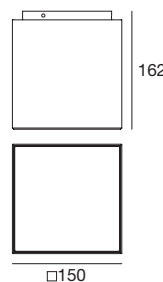
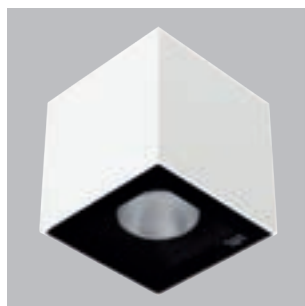

DALI	Cct	lm S - D	Optic
White 81889	M 2700	4469 - 3199	15 Spot (17°)
Black 81890	W 3000	4656 - 3334	30 Flood (26°)
Grey 81891	N 4000	4915 - 3519	60 W.Flood (46°)
DarkBrown 81892			

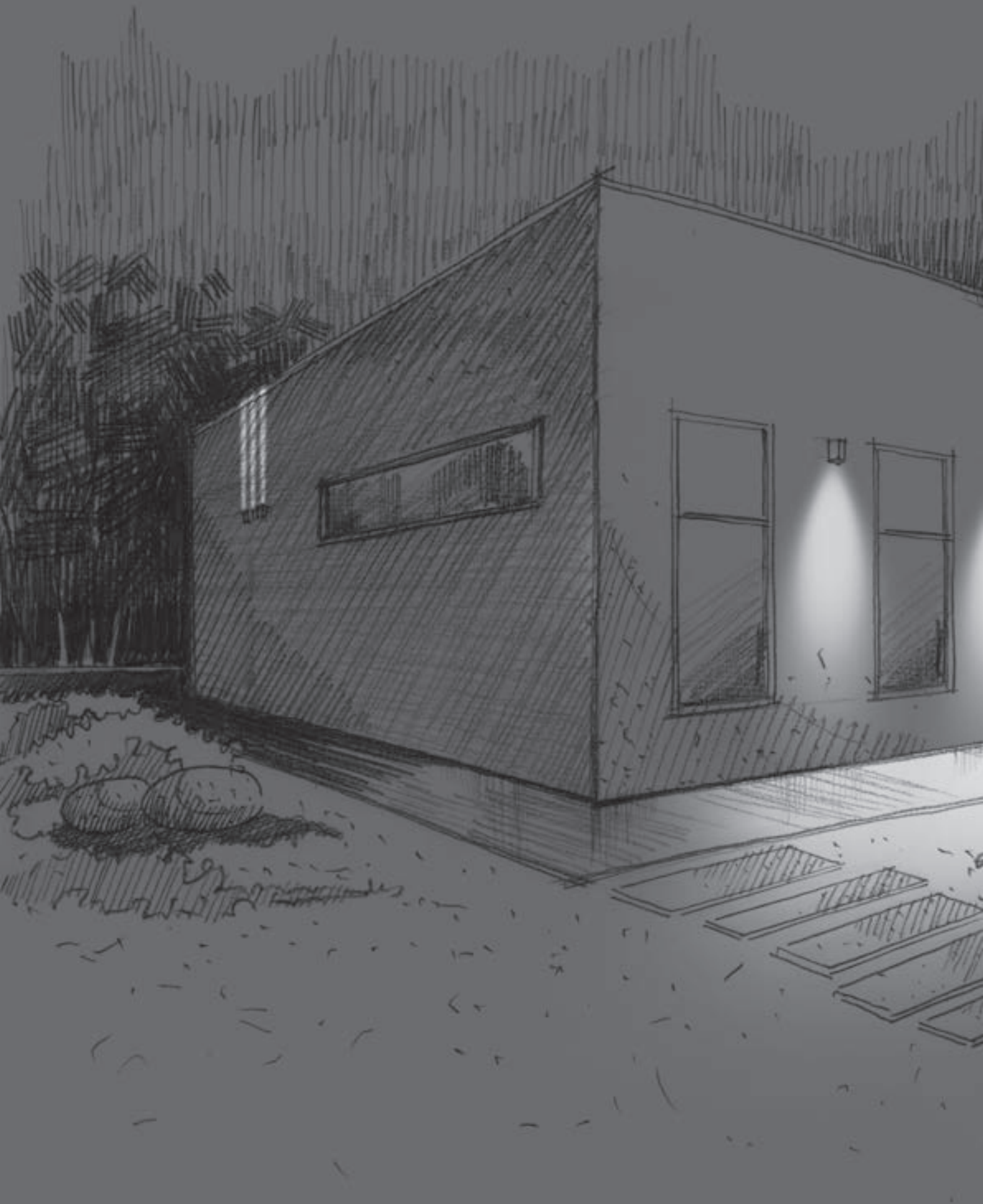

Wall lamps

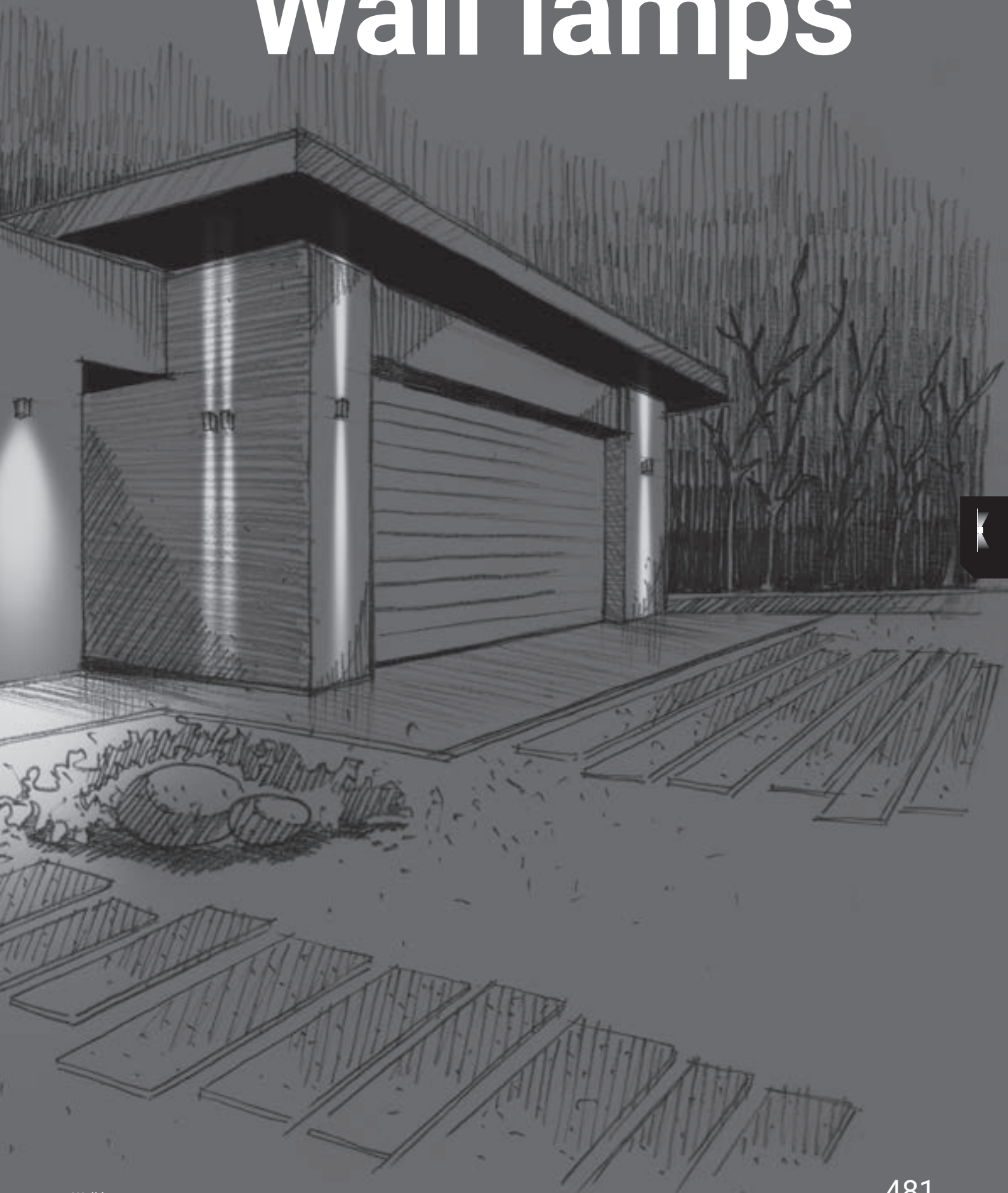

wall lamps range index

Vedette



Nail

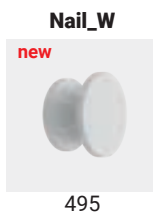

Cicada



Cem

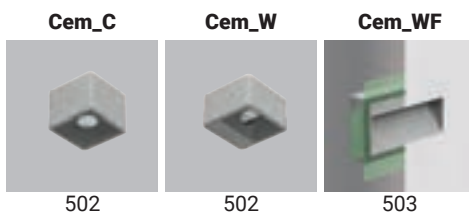

Ardilla66



Per











vedette

Matériaux
Corps en aluminium



Vedette_R Single emission | Wall light | 198-264 V AC | powerLED 4 W DC - 4,5 W AC

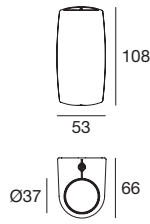

		Cct	lm S - D	Optic
White	82773	M 2700	490 - On req	15 Spot -
Black	82774	W 3000	490 - On req	30 Flood -
Grey	82775	N 4000	529 - On req	45 Flood -
DarkBrown	82776			00 General -
Sand	82777			

Vedette_R Single emission | Wall light | 198-264 V AC | arrayLED 8 W DC - 9 W AC

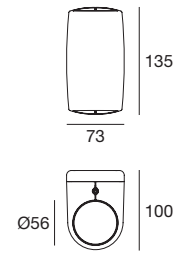

		Cct	lm S - D	Optic
White	82793	M 2700	1072 - On req	15 Spot -
Black	82794	W 3000	1117 - On req	30 Flood -
Grey	82795	N 4000	1180 - On req	60 W.Flood -
DarkBrown	82796			00 General -
Sand	82797			

Vedette_R Single emission | Wall light | 198-264 V AC | arrayLED 14 W DC - 15,5 W AC

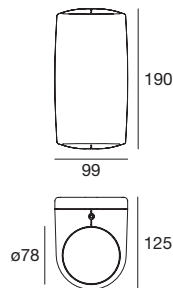

		Cct	lm S - D	Optic
White	82813	M 2700	1735 - On req	15 Spot -
Black	82814	W 3000	1808 - On req	30 Flood -
Grey	82815	N 4000	1909 - On req	60 W.Flood -
DarkBrown	82816			00 General -
Sand	82817			

Vedette_R Double emission | Wall light | 198-264 V AC | powerLED 8 W DC - 9 W AC

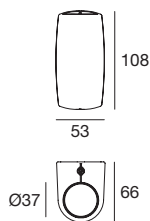

		Cct	lm S - D	Optic
White	82778	M 2700	980 - On req	15 Spot -
Black	82779	W 3000	980 - On req	30 Flood -
Grey	82780	N 4000	1058 - On req	45 Flood -
DarkBrown	82781			00 General -
Sand	82782			

Vedette_R Double emission | Wall light | 198-264 V AC | arrayLED 16 W DC - 18 W AC

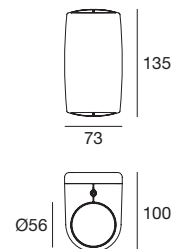

		Cct	lm S - D	Optic
White	82798	M 2700	2144 - On req	15 Spot -
Black	82799	W 3000	2234 - On req	30 Flood -
Grey	82800	N 4000	2360 - On req	60 W.Flood -
DarkBrown	82801			00 General -
Sand	82802			

Vedette_R Double emission | Wall light | 198-264 V AC | arrayLED 28 W DC - 30 W AC

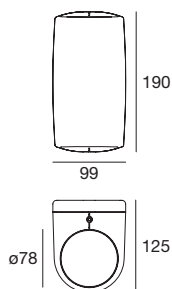

		Cct	lm S - D	Optic
White	82818	M 2700	3470 - On req	15 Spot -
Black	82819	W 3000	3616 - On req	30 Flood -
Grey	82820	N 4000	3818 - On req	60 W.Flood -
DarkBrown	82821			00 General -
Sand	82822			

Vedette_Q Single emission | Wall light | 198-264 V AC | powerLED 4 W DC - 4,5 W AC

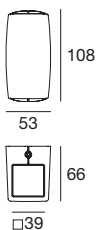

		Cct	lm S - D	Optic
White	82763	M 2700	490 - On req	15 Spot -
Black	82764	W 3000	490 - On req	30 Flood -
Grey	82765	N 4000	529 - On req	45 Flood -
DarkBrown	82766			00 General -
Sand	82767			

Vedette_Q Single emission | Wall light | 198-264 V AC | arrayLED 8 W DC - 9 W AC

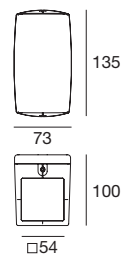

		Cct	lm S - D	Optic
White	82783	M 2700	1072 - On req	15 Spot -
Black	82784	W 3000	1117 - On req	30 Flood -
Grey	82785	N 4000	1180 - On req	60 W.Flood -
DarkBrown	82786			00 General -
Sand	82787			

Vedette_Q Single emission | Wall light | 198-264 V AC | arrayLED 14 W DC - 15,5 W AC

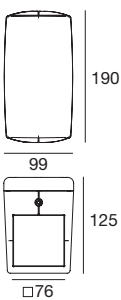
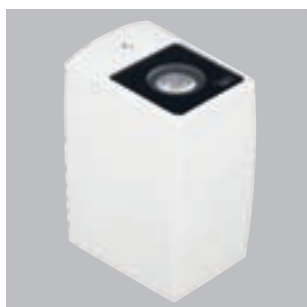

		Cct	lm S - D	Optic
White	82803	M 2700	1735 - On req	15 Spot -
Black	82804	W 3000	1808 - On req	30 Flood -
Grey	82805	N 4000	1909 - On req	60 W.Flood -
DarkBrown	82806			00 General -
Sand	82807			

Vedette_Q Double emission | Wall light | 198-164 V AC | powerLED 8 W DC - 9 W AC

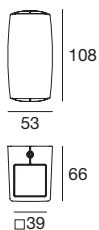

		Cct	lm S - D	Optic
White	82768	M 2700	980 - On req	15 Spot -
Black	82769	W 3000	980 - On req	30 Flood -
Grey	82770	N 4000	1058 - On req	45 Flood -
DarkBrown	82771			00 General -
Sand	82772			

Vedette_Q Double emission | Wall light | 198-264 V AC | arrayLED 16 W DC - 18 W AC

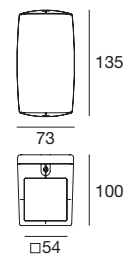

		Cct	lm S - D	Optic
White	82788	M 2700	2144 - On req	15 Spot -
Black	82789	W 3000	2234 - On req	30 Flood -
Grey	82790	N 4000	2360 - On req	60 W.Flood -
DarkBrown	82791			00 General -
Sand	82792			

Vedette_Q Double emission | Wall light | 198-264 V AC | arrayLED 28 W DC - 30 W AC

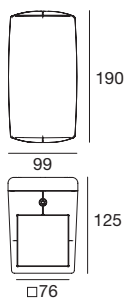
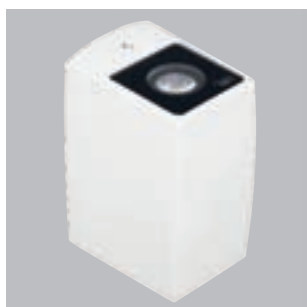

		Cct	lm S - D	Optic
White	82808	M 2700	3470 - On req	15 Spot -
Black	82809	W 3000	3616 - On req	30 Flood -
Grey	82810	N 4000	3818 - On req	60 W.Flood -
DarkBrown	82811			00 General -
Sand	82812			

Vedette_Q blade Single emission | Wall light | 198-264 V AC | powerLED 6 W DC - 7,2 W AC

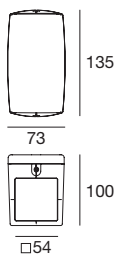

		Cct	lm S - D	Optic
White	97048	M 2700	657 - 585	05 N.Spot -
Black	97049	W 3000	699 - 624	
Grey	97050	N 4000	747 - 666	
DarkBrown	97051			
Sand	82515			

Vedette_Q blade Double emission | Wall light | 198-264 V AC | powerLED 12 W DC - 13 W AC

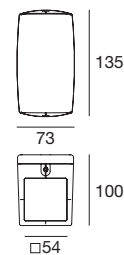

		Cct	lm S - D	Optic
White	97185	M 2700	1314 - 1170	05 N.Spot -
Black	97186	W 3000	1398 - 1248	
Grey	97187	N 4000	1494 - 1332	
DarkBrown	97188			
Sand	82516			

Vedette_Q blade Double emission | Wall light | 198-264 V AC | arrayLED 12 W DC - 13,5 W AC

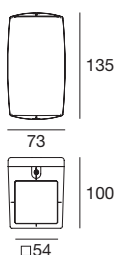

		Cct	lm S - D	Optic
White	97052	M 2700	1342 - 1219	56 5°+ 60° -
Black	97053	W 3000	1486 - On req	
Grey	97054	N 4000	1684 - On req	
DarkBrown	97055			
Sand	82517			

Optic 5° powerLED

Vedette_Q blade Single emission | Wall light | 198-264 V AC | powerLED 24 W DC - 28,8 W AC

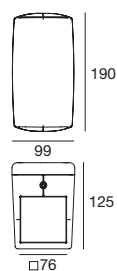

		Cct	lm S - D	Optic
White	91599	M 2700	2288 - On req	05 N.Spot (4°)
Black	91600	W 3000	2288 - On req	
Grey	91601	N 4000	2463 - On req	
DarkBrown	91602			
Sand	82518			

Vedette_Q Asymm. Single emission | Wall light | 198-264 V AC | powerLED 6 W DC - 7,2 W AC

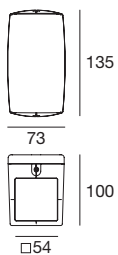

		Cct	lm S - D	Optic
White	81574	M 2700	685 - On req	07 Asymm. -
Black	81575	W 3000	739 - On req	
Grey	81576	N 4000	985 - On req	
DarkBrown	81577			
Sand	82519			

Vedette_Q Asymm Double emission | Wall light | 198-264 V AC | powerLED 13,5 W DC - 15 W AC

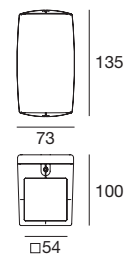

		Cct	lm S - D	Optic
White	81578	M 2700	1324 - On req	62 Asymm. +5° -
Black	81579	W 3000	1413 - On req	63 Asymm. +30° -
Grey	81580	N 4000	1730 - On req	64 Asymm. +60° -
DarkBrown	81581			
Sand	82520			

Vedette_Q asymmetric | Wall light | 198-264 V AC | arrayLED 14 W DC - 15 W AC

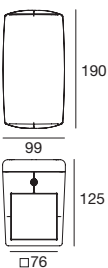

		Cct	lm S - D	Optic
White	81582	M 2700	2077 - On req	07 Asymm.
Black	81583	W 3000	2165 - On req	
Grey	81584	N 4000	2285 - On req	
DarkBrown	81585			

Vedette_Q Double_asymmetric | Wall light | 198-264 V AC | arrayLED 28 W DC - 30 W AC

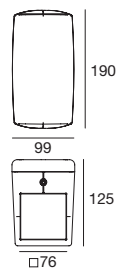

		Cct	lm S - D	Optic
White	81586	M 2700	3812 - On req	07 Asymm. -
Black	81587	W 3000	3973 - On req	62 Asymm. +5° -
Grey	81588	N 4000	4194 - On req	63 Asymm. +30° -
DarkBrown	81589			64 Asymm. +60° -

Optic 5° powerLED

nail

Matériaux

Corps en aluminium

Diffuseur en polycarbonate



Nail_W | Wall light | 180-264 V AC | arrayLED 6,5 W DC - 7 W AC

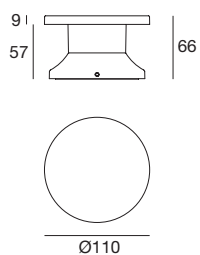

		Cct	Im S - D	Optic
White	84184	M 2700	552 - On req	00 General -
BK Grey	84185	W 3000	591 - On req	
DarkBrown	84186	N 4000	638 - On req	
Grey	84187			
Primer	84188			

Available from April 2021

Optique radiale

Appareil à LED pour l'extérieur avec alimentation intégrée, doté d'une source lumineuse cachée avec une optique conçue par le bureau d'études de Linealight, logée dans un monobloc de méthacrylate, qui crée une émission à très faible luminance avec un faisceau lumineux radial à 360°.



Finition pouvant être peinte

En complément de quatre finitions différentes, Nail peut être vendu en finition "primer", ce qui permet de le peindre dans les tons de l'architecture dans laquelle il est installé.



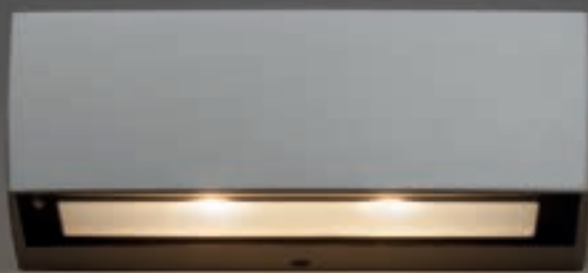

cicada

Matériaux

Corps en aluminium

Cicada Single emission | Wall light | 198-264 V AC | arrayLED 6,5 W DC - 8 W AC

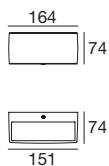

		Cct	lm S - D	Optic
White	83614	M 2700	1072 - On req	00 General -
Black	83615	W 3000	1117 - On req	12 E.W.Flood-
Grey	83616	N 4000	1180 - On req	
DarkBrown	83617			

Cicada Double emission | Wall light | 198-264 V AC | arrayLED 13 W DC - 16 W AC

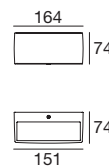

		Cct	lm S - D	Optic
White	83618	M 2700	2144 - On req	00 General -
Black	83619	W 3000	2234 - On req	12 E.W.Flood-
Grey	83620	N 4000	2360 - On req	
DarkBrown	83621			

Cicada Single emission | Wall light | 198-264 V AC | arrayLEDs 13 W DC - 16 W AC

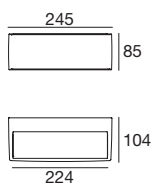

		Cct	lm S - D	Optic
White	83622	M 2700	2144 - On req	00 General -
Black	83623	W 3000	2234 - On req	12 E.W.Flood-
Grey	83624	N 4000	2360 - On req	
DarkBrown	83625			

Cicada Double emission | Wall light | 198-264 V AC | arrayLEDs 26 W DC - 30 W AC

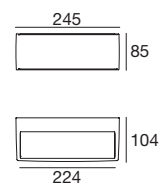
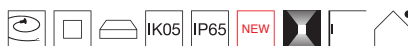

		Cct	lm S - D	Optic
White	83626	M 2700	4288 - On req	00 General -
Black	83627	W 3000	4468 - On req	12 E.W.Flood-
Grey	83628	N 4000	4720 - On req	
DarkBrown	83629			





cem

Matériaux
Corps en béton



cem lighting concept

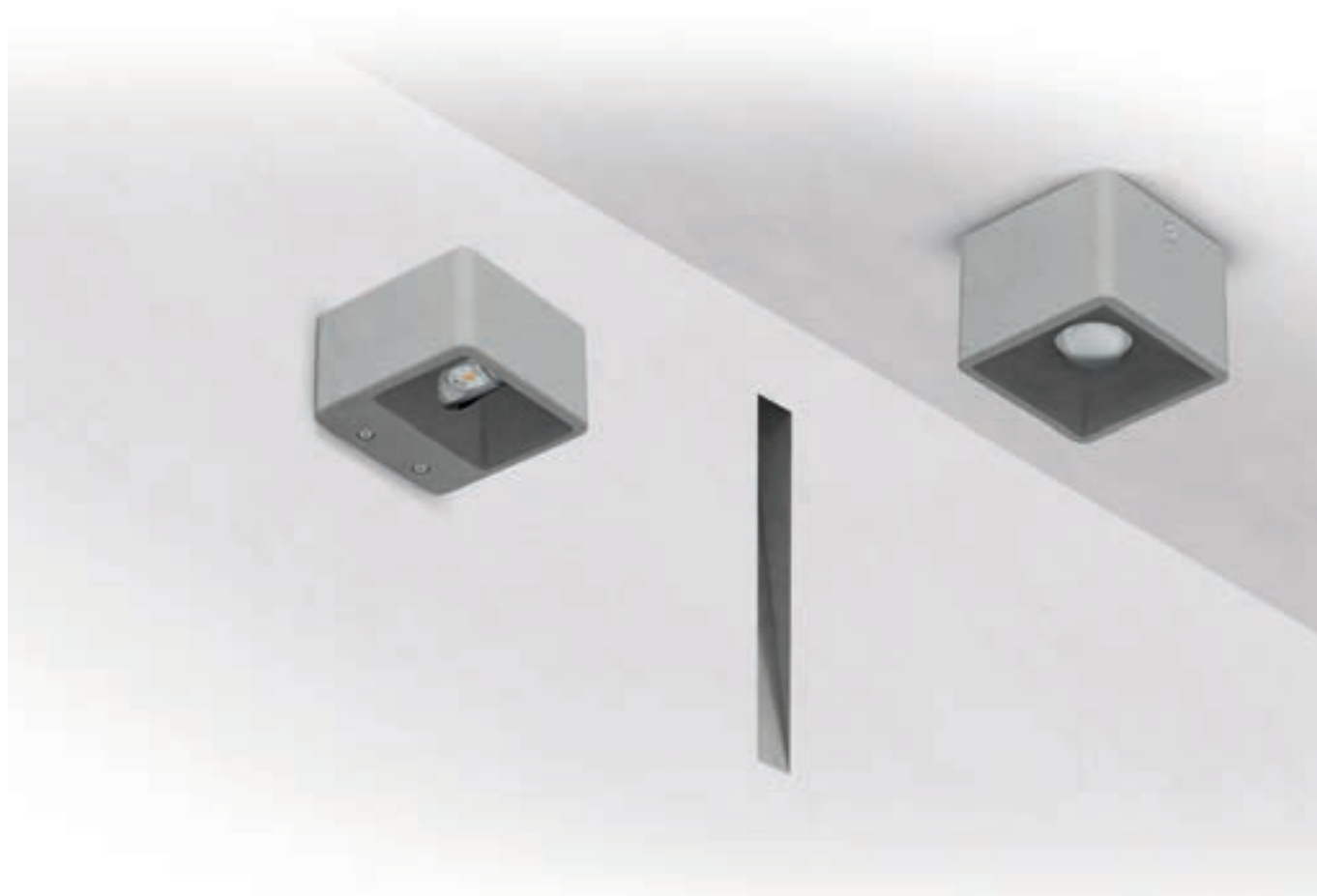

	_W Wall	_WF Wall Frameless	_C Ceiling
1,5W	159 x 59 mm	450 x 130 mm	-
6,5W	72 x 120 mm	-	90 x 120 mm
7,5W	-	210 x 370 mm	-
14W	72 x 350 mm	-	-
Finish	Cement	Cement	Cement
CRI 80	3000K - 4000K	3000K	3000K - 4000K
Optics	General Extra Wide Flood (1,5 W)	General	Flood
Control	On/Off	On/Off - DALI	On/Off

Cem_C | Ceiling Lights | 220-240 V | arrayLED 6,5 W DC - 8 W AC

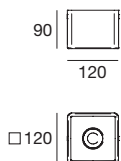
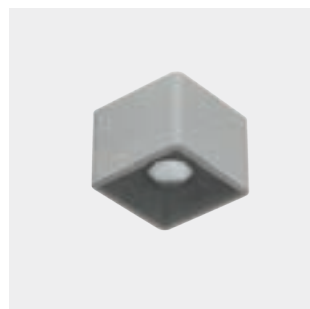

		Cct	lm S - D	Optic
Cement	64564	W 3000	770 - 491	70 Flood (68°)
		N 4000	831 - 491	

Cem_W | Wall Lights | 100-240 V | arrayLED 6,5 W DC - 9 W AC

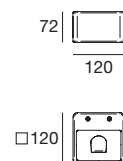

		Cct	lm S - D	Optic
Cement	64561	W 3000	876 - 595	00 General
		N 4000	946 - 595	

Cem_W | Wall Lights | 100-240 V | arrayLED 6,5 W DC - 9 W AC

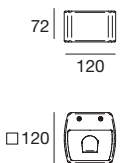

		Cct	lm S - D	Optic
Cement	64560	W 3000	876 - 595	00 General
		N 4000	946 - 595	

Cem_W | Wall Lights | 180-264 V | topLED 14 W DC - 16,8 W AC

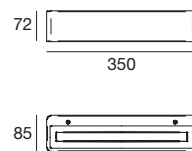

		Cct	lm S - D	Optic
Cement	64562	W 3000	2218 - 1230	00 General
		N 4000	2321 - 1345	

64562W00

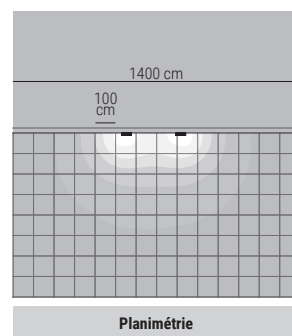
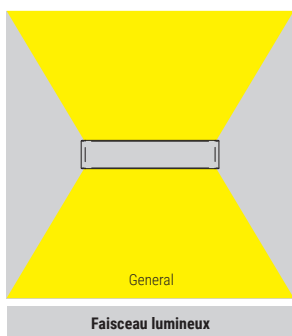
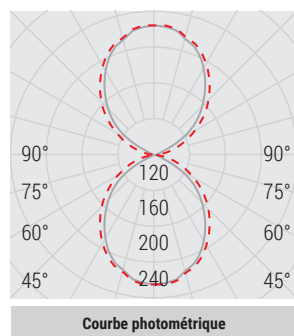

Cem_W | Wall Lights | 100-240 V | powerLED 1,5 W DC - 2,5 W AC

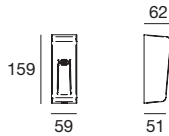

	Cct	Im S - D	Optic
Cement 64563	W 3000	199 - 73	60 E.W.Flood(120°)
	N 4000	213 - 73	

Cem_WF | Wall Lights | powerLED 1,5 W DC 500 mA

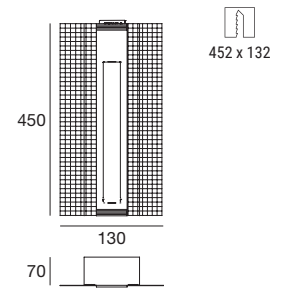

	Cct	Im S - D	Optic
Cement 64506	W 3000	199 - On req	00 General -

Électronique

89422	89423	99181	99185	83101
ON/OFF 1 - 2 art. p 65 x l 74 x h 27	ON/OFF 2 - 3 art. p 65 x l 74 x h 27	ON/OFF 3 - 6 art. p 80 x l 100 x h 31	ON/OFF 6 - 12 art. p 92 x l 117 x h 38	DALI 1 - 12 art. p 54 x l 121 x h 26

Boîtier d'encastrement Pag. 503

Cem_WF | Wall Lights | topLED 7,5 W DC 180 mA

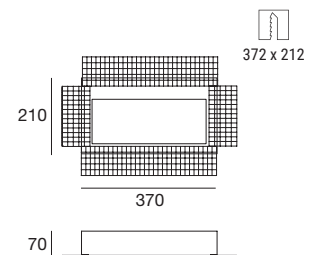

	Cct	Im S - D	Optic
Cement 64505	W 3000	1110 - 370	00 General -

Électronique

99716
ON/OFF 1 art. p 65 x l 74 x h 27

Boîtier d'encastrement Pag. 503

Boîtier d'encastrement

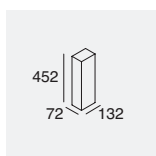

description	
65002	Boîtier d'encastrement
suitable for: Cem_WF 1,5W	

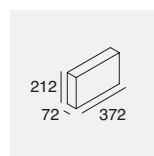

description	
65005	Boîtier d'encastrement
suitable for: Cem_WF 7,5W	



ardilla66

Matériaux
Corps en aluminium

Ardilla66 Single emission | Wall light | 198-264 V AC | powerLED 4,1 W DC - 5,7 W AC

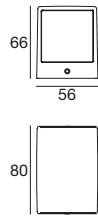

		Cct	lm S - D	Optic
White	94167	M 2700	490 - 267	00 General -
Black	94168	W 3000	490 - 267	
Grey	94169	N 4000	529 - 289	
DarkBrown	94170			

RTG 94167W00

Ardilla66 Double emission | Wall light | 198-264 V AC | powerLED 7,6 DC - 10 W AC

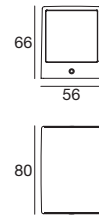

		Cct	lm S - D	Optic
White	94204	M 2700	980 - 562	00 General -
Black	94208	W 3000	980 - 562	
Grey	94209	N 4000	1058 - 607	
DarkBrown	94214			

RTG 94204W00

Ardilla66 Double emission | Wall light | 198-264 V AC | powerLED 7,6 DC - 10 W AC

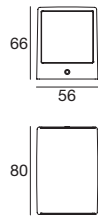

		Cct	lm S - D	Optic
White	94215	M 2700	980 - 373	61 General +6° -
Black	94223	W 3000	980 - 373	
Grey	94224	N 4000	1058 - 403	
DarkBrown	94411			



per

Matériaux
Corps en aluminium

Per | Wall light | powerLED 4 W DC 630 mA

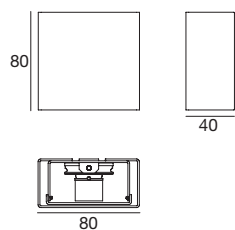

		Cct	Im S - D	Optic
White	92619	M 2700	438 - On req	12 E.W.Flood
Steel	92622	W 3000	466 - 316	
Grey	92620	N 4000	498 - 337	
DarkBrown	92621	R - G - B - Y on request		

Électronique

89420	99179	99186	83102
ON/OFF 1 art. p 66 x l 74 x h 27	ON/OFF 2 - 3 art. p 80 x l 100 x h 31	ON/OFF 3 - 6 art. p 92 x l 117 x h 38	DALI 1 - 7 art. p 54 x l 122 x h 26

RTG 92619W12

Installation facile

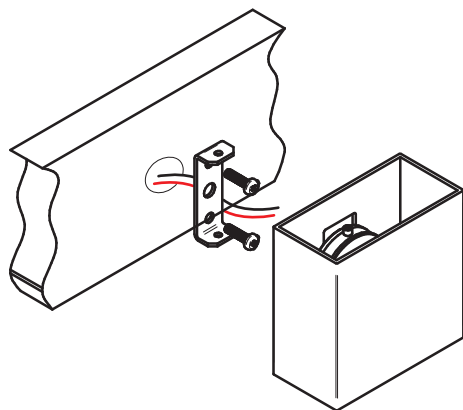

H-Farm | Treviso, Italy



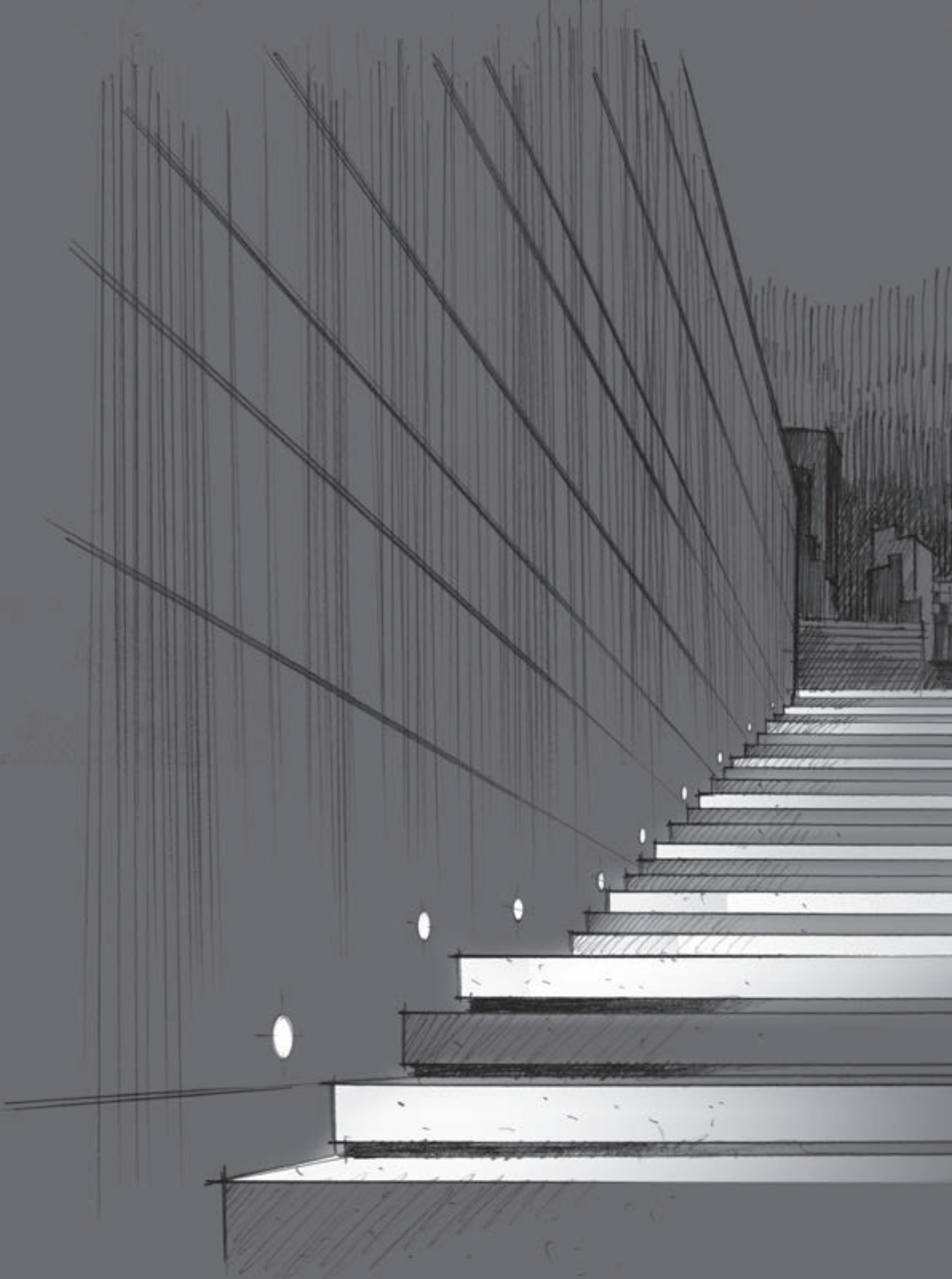

Wall path markers



wall path-markers range index

OptiWall



Envelope

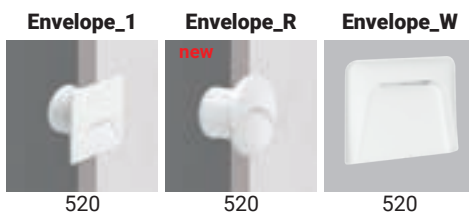

Intake

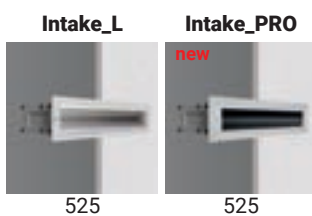

Orma

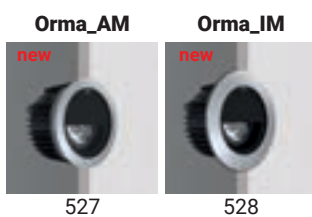

Step66



Chim



Quara

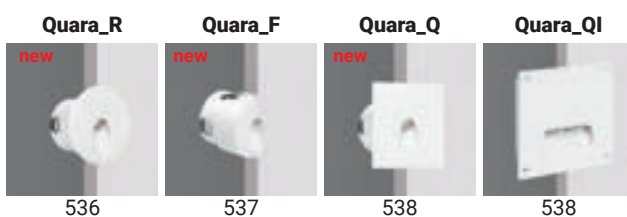

Cut

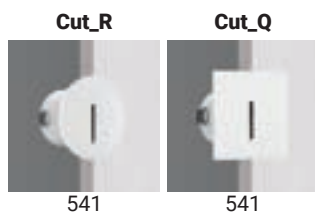

Clip

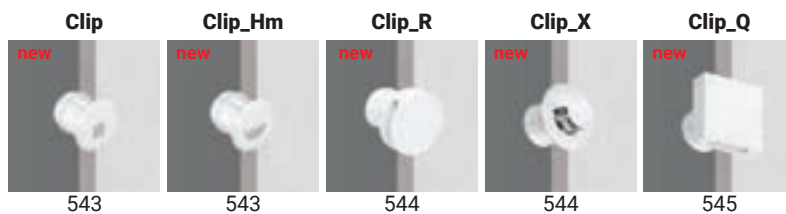

Sand

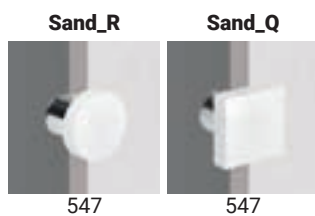



optiwall

Matériaux

Corps en aluminium

Diffuseur PMMA transparent



Chemin lumineux révolutionnaire

Optiwall révolutionne le concept de chemin lumineux : plus qu'une applique, il s'agit d'une véritable fenêtre de lumière qui, grâce aux microgravures de la technologie OptiLight™, ne produit aucun éblouissement. Situé à la hauteur d'un chemin lumineux, ce luminaire éclaire non seulement le sol de manière asymétrique, mais également l'ensemble de l'environnement, avec une lumière douce et une grande profondeur, en valorisant tous les éléments.



IP65

optilight

Épaisseur réduite

Le design Optiwall est unique : le luminaire mesure seulement 18 mm d'épaisseur, un encombrement minimal obtenu grâce notamment à des caractéristiques particulières telles des vis dissimulées et placées intelligemment et un support entièrement encastré dans le corps de la lampe.



Support de fixation



81296W0

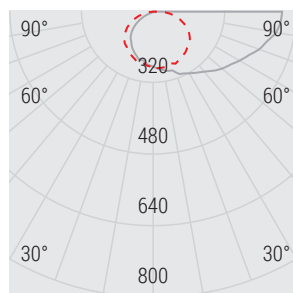

Courbe photométrique

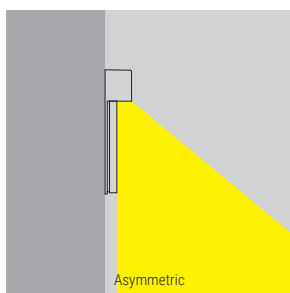

Faisceau lumineux

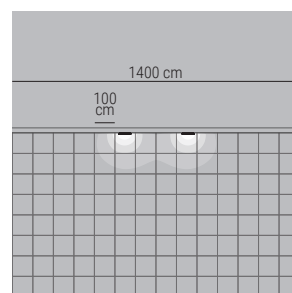
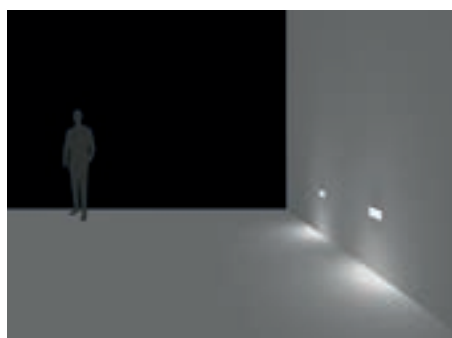

Planimétrie

Optiwall | Path-marker | 24 V DC | topLED 3,5 W DC

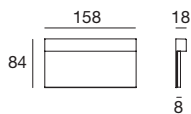

		Cct	Im S - D	Optic
White	81296	M 2700	366 - On req	07 Asymm. -
Grey	81297	W 3000	384 - On req	
DarkBrown	81298	N 4000	401 - On req	
BK Grey	81299			

Électronique

89488	89179	89359	99332	99722
ON/OFF 1 - 4 art.	ON/OFF 1 - 6 art.	ON/OFF 1 - 13 art.	0/1-10V 1 - 42 art.	DALI 1 - 26 art.
p 80 x l 100 x h 31	p 92 x l 117 x h 38	p 115 x l 140 x h 50	p 150 x l 60 x h 35	p 191 x l 63 x h 38

Optiwall | Path-marker | 24 V DC | topLED 3,5 W DC

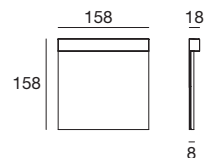

		Cct	Im S - D	Optic
White	81300	M 2700	366 - On req	07 Asymm. -
Grey	81301	W 3000	384 - On req	
DarkBrown	81302	N 4000	401 - On req	
BK Grey	81303			

Électronique

89488	89179	89359	99332	99722
ON/OFF 1 - 4 art.	ON/OFF 1 - 6 art.	ON/OFF 1 - 13 art.	0/1-10V 1 - 42 art.	DALI 1 - 26 art.
p 80 x l 100 x h 31	p 92 x l 117 x h 38	p 115 x l 140 x h 50	p 150 x l 60 x h 35	p 191 x l 63 x h 38

Optiwall | Path-marker | 24 V DC | topLED 7 W DC

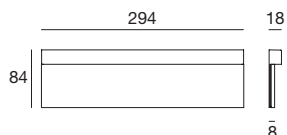

		Cct	Im S - D	Optic
White	81304	M 2700	732 - On req	07 Asymm. -
Grey	81305	W 3000	767 - On req	
DarkBrown	81306	N 4000	803 - On req	
BK Grey	81307			

Électronique

89179	89359	99331	99332	99722
ON/OFF 1 - 3 art.	ON/OFF 1 - 6 art.	ON/OFF 1 - 21 art.	0/1-10V 1 - 21 art.	DALI 1 - 17 art.
p 92 x l 117 x h 38	p 115 x l 140 x h 50	p 150 x l 60 x h 35	p 150 x l 60 x h 35	p 191 x l 63 x h 38





envelope

Matériaux
Corps en aluminium



envelope range



	Envelope_1 Square	Envelope_R Round	Envelope_W Wall
1 W	40 x 40 mm	∅ 40 mm	120 x 88 mm
6 W			170 x 168 mm
9,5 W / 16 W			270 x 125 mm
Finish	<div style="display: flex; flex-wrap: wrap; gap: 2px;"> <div style="border: 1px solid black; padding: 2px;">White</div> <div style="border: 1px solid black; padding: 2px;">Grey</div> <div style="border: 1px solid black; padding: 2px;">BK Grey</div> <div style="border: 1px solid black; padding: 2px;">DarkBrown</div> <div style="border: 1px solid black; padding: 2px;">Black</div> <div style="border: 1px solid black; padding: 2px;">Brass</div> </div>	<div style="display: flex; flex-wrap: wrap; gap: 2px;"> <div style="border: 1px solid black; padding: 2px;">White</div> <div style="border: 1px solid black; padding: 2px;">Grey</div> <div style="border: 1px solid black; padding: 2px;">BK Grey</div> <div style="border: 1px solid black; padding: 2px;">DarkBrown</div> <div style="border: 1px solid black; padding: 2px;">Black</div> <div style="border: 1px solid black; padding: 2px;">Brass</div> </div>	<div style="display: flex; flex-wrap: wrap; gap: 2px;"> <div style="border: 1px solid black; padding: 2px;">White</div> <div style="border: 1px solid black; padding: 2px;">Grey</div> <div style="border: 1px solid black; padding: 2px;">BK Grey</div> <div style="border: 1px solid black; padding: 2px;">DarkBrown</div> </div>
topLED	2700K - 3000K - 4000K	2700K - 3000K - 4000K	2700K - 3000K - 4000K
Optics	Asymmetric	Asymmetric	Asymmetric
 Driver	On/Off - DALI	On/Off - DALI	On/Off - 0/1-10 V - DALI
 Driver	-	-	On/Off

Élégant et essentiel

Envelope se présente sous la forme d'un seul élément compact à l'aspect épuré et minimaliste. Les vis sont en effet dissimulées. Le système d'attache rapide avec raccord à baïonnette facilite l'installation. Le boîtier d'encastrement dissimulé préserve l'esthétique du produit. Il peut également être installé à l'aide d'un support de fixation dédié.



Finitions

- blanc RAL9003
- gris classique RAL9006
- gris anthracite RAL7021
- dark brown
- noir
- laiton

Only for
Envelope_1
Envelope_R

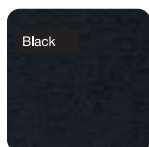

Only for
Envelope_1
Envelope_R

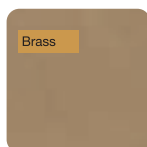

Optique en retrait, design asymétrique

La source en retrait est dissimulée. Le luminaire est par conséquent entièrement masqué (full cut-off) : l'œil ne voit que l'émission, appréciant son aspect propre et confortable. Le design légèrement asymétrique dirige le faisceau vers le sol.

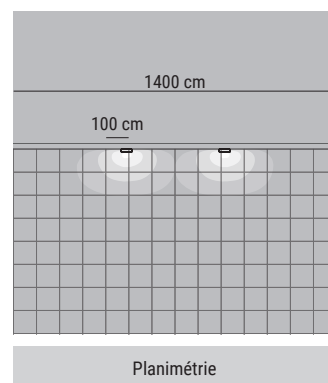

Envelope_1 | Path-marker | powerLED 1 W DC 350 mA

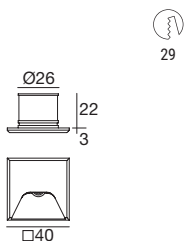

		Cct	Im S - D	Optic
White	96976	M 2700	136 - On req	07 Asymm. -
Grey	96978	W 3000	145 - 113	
BK Grey	80605	N 4000	155 - 120	
DarkBrown	96979			
Black	96977			
Brass	83613			

Électronique

89419	89421	99183	83100
ON/OFF 1 - 2 art. p 65 x 174 x h 27	ON/OFF 3 - 6 art. p 65 x 174 x h 27	ON/OFF 6 - 12 art. p 80 x 1100 x h 31	DALI 1 - 14 art. p 54 x 1121 x h 26

Boîtier d'encastrement Pag. 521

RTG 96976W07 / 96976N07 / 96978W07 / 96979W07 / 80605W07

Envelope_W | Path-marker | 24 V DC | topLED 1 W DC

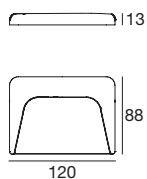

		Cct	Im S - D	Optic
White	97167	W 3000	136 - On req.	07 Asymm. -
Grey	97169	N 4000	136 - On req.	
BK Grey	81339			
DarkBrown	81340			

Électronique

89488	89179	89359	99332	99722
ON/OFF 1 - 14 art. p 80 x 1100 x h 31	ON/OFF 1 - 24 art. p 92 x 1117 x h 38	ON/OFF 1 - 48 art. p 115 x 1140 x h 50	0/1-10V 1 - 150 art. p 150 x 160 x h 35	DALI 1 - 120 art. p 191 x 163 x h 38

RTG 97167W07

Envelope_R | Path-marker | powerLED 1 W DC 350 mA

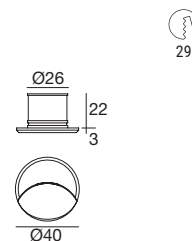

		Cct	Im S - D	Optic
White	83601	M 2700	136 - On req	07 Asymm. -
Grey	83603	W 3000	145 - 113	
BK Grey	84071	N 4000	155 - 120	
DarkBrown	83604			
Black	83602			
Brass	84072			

Électronique

89419	89421	99183	83100
ON/OFF 1 - 2 art. p 65 x 174 x h 27	ON/OFF 3 - 6 art. p 65 x 174 x h 27	ON/OFF 6 - 12 art. p 80 x 1100 x h 31	DALI 1 - 14 art. p 54 x 1121 x h 26

Boîtier d'encastrement Pag. 521

Envelope_W | Path-marker | 24 V DC | topLED 1 W DC

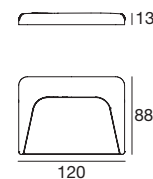

		Cct	Im S - D	Optic
White	97170	W 3000	136 - On req.	07 Asymm. -
Grey	97172	N 4000	136 - On req.	
BK Grey	81341			
DarkBrown	81342			

Électronique

89488	89179	89359	99332	99722
ON/OFF 1 - 14 art. p 80 x 1100 x h 31	ON/OFF 1 - 24 art. p 92 x 1117 x h 38	ON/OFF 1 - 48 art. p 115 x 1140 x h 50	0/1-10V 1 - 150 art. p 150 x 160 x h 35	DALI 1 - 120 art. p 191 x 163 x h 38

 **Boîtier d'encastrement Pag. 521**

RTG 97170W07

Envelope_W | Path-marker | 198-264 V AC | topLED 6 W DC - 8 W AC

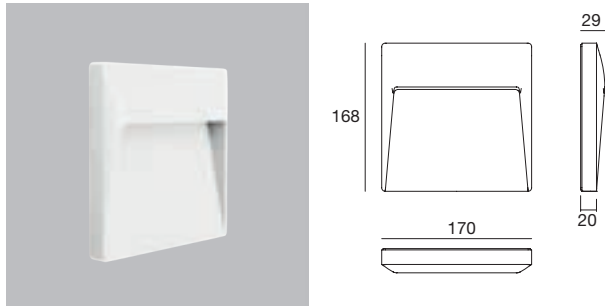

		Cct	lm S - D	Optic
White	81343	M 2700	669 - On req	07 Asymm. -
Grey	81291	W 3000	699 - On req	
BK Grey	81290	N 4000	724 - On req	
DarkBrown	81292			

RTG 81343W07

Boîtier d'encastrement Pag. 521

Envelope_W | Path-marker | 198-264 V AC | topLED

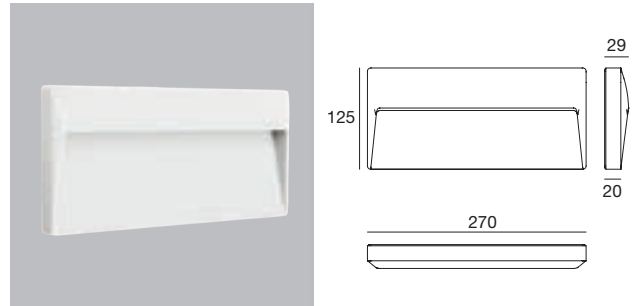
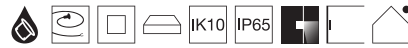

		Cct	lm S - D	Optic
White	81344	M 2700	1115 - On req	07 Asymm. -
Grey	81294	W 3000	1166 - On req	
BK Grey	81293	N 4000	1207 - On req	
DarkBrown	81295			

		Cct	lm S - D	Optic
White	81512	M 2700	1705 - On req	07 Asymm. -
Grey	81510	W 3000	1782 - On req	
BK Grey	81509	N 4000	1846 - On req	
DarkBrown	81511			

Boîtier d'encastrement Pag. 521

Solution avec boîtier encastrable (Envelope_W 6W - 9,5W - 16W)

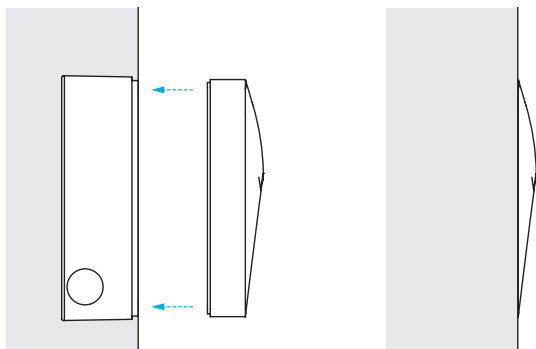

Boîtier d'encastrement

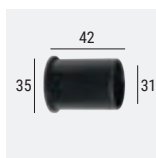

description	type
84336 Boîtier d'encastrement	PVC
suitable for: Envelope_1 - Envelope_R	

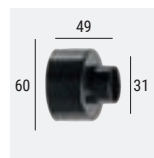

description	type
84915 Boîtier d'encastrement	PVC
suitable for: Envelope_1 - Envelope_R	



description
98111 Boîtier d'encastrement (standard box mod. 503)
suitable for: Envelope_W 1 W

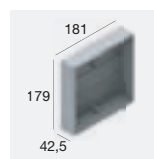

description
99744 Boîtier d'encastrement
suitable for: Envelope_W 6 W

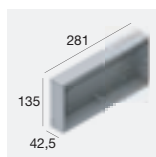

description
99745 Boîtier d'encastrement
suitable for: Envelope_W 9,5-16 W







intake

Matériaux

Corps en aluminium

Bride en inox AISI 316

Intake_L | Path-marker | 100-240 V AC | topLED 6 W DC - 7 W AC

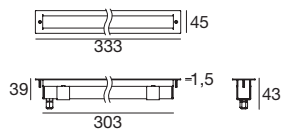

		Cct	Im S - D	Optic
Steel	97714	W 3000	672 - 672	07 Asymm. -
		N 4000	714 - 714	

RTG 97714W07

Boîtier d'encastrement Pag. 525

Intake_L | Path-marker | 100-240 V AC | topLED 13 W DC - 18 W AC

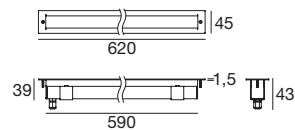

		Cct	Im S - D	Optic
Steel	97715	W 3000	1344 - 1344	07 Asymm. -
		N 4000	1428 - 1428	

Boîtier d'encastrement Pag. 525

IntakePRO | Linear profiles | 100-240V AC | topLED | 15 W DC - 17 W AC

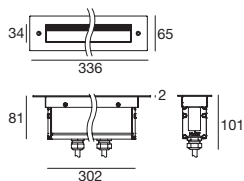

		Cct	Im S - D	Optic
Steel	83874	W 3000	895 - 508	07 Asymm. -
		N 4000	937 - 532	

Boîtier d'encastrement Pag. 525

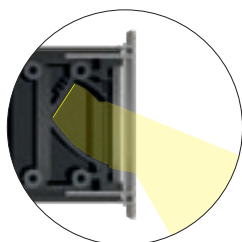

Boîtier d'encastrement

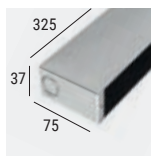

	description
98496	Boîtier d'encastrement
suitable for: Intake_L 6W	

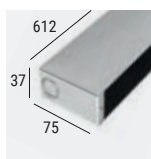

	description
98497	Boîtier d'encastrement
suitable for: Intake_L 12W	

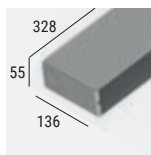

	description
98577	Boîtier d'encastrement
suitable for: IntakePRO	



orma

Matériaux

Corps en aluminium

Bride en inox AISI 316L

Orma_AM | Up-Light | powerLED

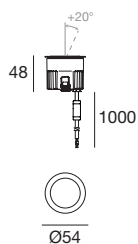

C.C. 4W DC 350 mA	Cct	Im S - D	Optic
Steel Alu 83631	M 2700	490 - On req.	07 Asymm. -
	W 3000	490 - On req.	
	N 4000	529 - On req.	

Électronique

89421	99183	83100
ON/OFF 1 art. p 65 x l 74 x h 27	ON/OFF 1 - 2 art. p 80 x l 100 x h 31	DALI 1 - 4 art. p 54 x l 121 x h 26

C.V. 24 V - 5W DC	Cct	Im S - D	Optic
Steel Alu 83633	M 2700	490 - On req.	07 Asymm. -
	W 3000	490 - On req.	
	N 4000	529 - On req.	

Électronique

89488	89179	89359	99332	99722
ON/OFF 1 - 2 art. p 80 x l 100 x h 31	ON/OFF 1 - 4 art. p 92 x l 117 x h 38	ON/OFF 1 - 9 art. p 115 x l 140 x h 50	0/1-10V 1 - 29 art. p 150 x l 60 x h 35	DALI 1 - 23 art. p 191 x l 63 x h 38

Boîtier d'encastrement Pag. 529

Orma_AM | Up-Light | arrayLED

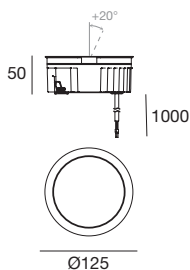

C.C. - 12W DC 350 mA	Cct	Im S - D	Optic
Steel Alu 83639	M 2700	1724 - On req.	07 Asymm. -
	W 3000	1724 - On req.	
	N 4000	1854 - On req.	

Électronique

99183	83100
ON/OFF 1 art. p 80 x l 100 x h 31	DALI 1 art. p 54 x l 121 x h 26

C.V. 24 V - 13W DC	Cct	Im S - D	Optic
Steel Alu 83641	M 2700	1724 - On req.	07 Asymm. -
	W 3000	1724 - On req.	
	N 4000	1854 - On req.	

Électronique

89179	89359	99331	99332	99722
ON/OFF 1 art. p 92 x l 117 x h 38	ON/OFF 1 - 3 art. p 115 x l 140 x h 50	ON/OFF 1 - 10 art. p 150 x l 60 x h 35	0/1-10V 1 - 10 art. p 150 x l 60 x h 35	DALI 1 - 8 art. p 191 x l 63 x h 38

Boîtier d'encastrement Pag. 529

Orma_AM | Up-Light | arrayLED

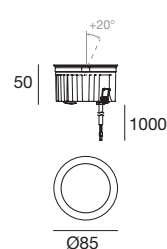

C.C. - 8W DC 220 mA	Cct	Im S - D	Optic
Steel Alu 83635	M 2700	1088 - On req.	07 Asymm. -
	W 3000	1088 - On req.	
	N 4000	1173 - On req.	

Électronique

99342	83154
ON/OFF 1 art. p 80 x l 100 x h 31	DALI 1 art. p 54 x l 121 x h 26

C.V. 24 V - 9W DC	Cct	Im S - D	Optic
Steel Alu 83637	M 2700	1209 - On req.	07 Asymm. -
	W 3000	1209 - On req.	
	N 4000	1303 - On req.	

Électronique

89179	89359	99331	99332	99722
ON/OFF 1 - 2 art. p 92 x l 117 x h 38	ON/OFF 1 - 5 art. p 115 x l 140 x h 50	ON/OFF 1 - 15 art. p 150 x l 60 x h 35	0/1-10V 1 - 15 art. p 150 x l 60 x h 35	DALI 1 - 12 art. p 191 x l 63 x h 38

Boîtier d'encastrement Pag. 529

Orma_IM | Up-Light | powerLED

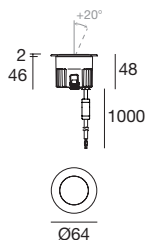

C.C. 4W DC 350 mA	Cct	Im S - D	Optic
Steel Alu 83630	M 2700	490 - On req.	07 Asymm. -
	W 3000	490 - On req.	
	N 4000	529 - On req.	

Électronique

89421	99183	83100
ON/OFF 1 art. p 65 x l 74 x h 27	ON/OFF 1 - 2 art. p 80 x l 100 x h 31	DALI 1 - 4 art. p 54 x l 121 x h 26

C.V. 24 V - 5W DC	Cct	Im S - D	Optic
Steel Alu 83632	M 2700	490 - On req.	07 Asymm. -
	W 3000	490 - On req.	
	N 4000	529 - On req.	

Électronique

89488	89179	89359	99332	99722
ON/OFF 1 - 2 art. p 80 x l 100 x h 31	ON/OFF 1 - 4 art. p 92 x l 117 x h 38	ON/OFF 1 - 9 art. p 115 x l 140 x h 50	0/1-10V 1 - 29 art. p 150 x l 60 x h 35	DALI 1 - 23 art. p 191 x l 63 x h 38

Boîtier d'encastrement Pag. 529

Orma_IM | Up-Light | arrayLED

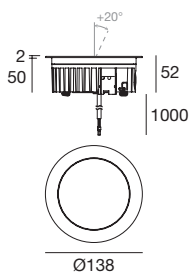

C.C. - 12W DC 350 mA	Cct	Im S - D	Optic
Steel Alu 83638	M 2700	1724 - On req.	07 Asymm. -
	W 3000	1724 - On req.	
	N 4000	1854 - On req.	

Électronique

99183	83100
ON/OFF 1 art. p 80 x l 100 x h 31	DALI 1 art. p 54 x l 121 x h 26

C.V. 24 V - 13W DC	Cct	Im S - D	Optic
Steel Alu 83640	M 2700	1724 - On req.	07 Asymm. -
	W 3000	1724 - On req.	
	N 4000	1854 - On req.	

Électronique

89179	89359	99331	99332	99722
ON/OFF 1 art. p 92 x l 117 x h 38	ON/OFF 1 - 3 art. p 115 x l 140 x h 50	ON/OFF 1 - 10 art. p 150 x l 60 x h 35	0/1-10V 1 - 10 art. p 150 x l 60 x h 35	DALI 1 - 8 art. p 191 x l 63 x h 38

Boîtier d'encastrement Pag. 529

Orma_IM | Up-Light | arrayLED

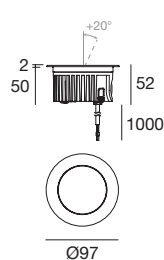

C.C. - 8W DC 220 mA	Cct	Im S - D	Optic
Steel Alu 83634	M 2700	1088 - On req.	07 Asymm. -
	W 3000	1088 - On req.	
	N 4000	1173 - On req.	

Électronique

99342	83154
ON/OFF 1 art. p 80 x l 100 x h 31	DALI 1 art. p 54 x l 121 x h 26

C.V. 24 V - 9W DC	Cct	Im S - D	Optic
Steel Alu 83636	M 2700	1209 - On req.	07 Asymm. -
	W 3000	1209 - On req.	
	N 4000	1303 - On req.	

Électronique

89179	89359	99331	99332	99722
ON/OFF 1 - 2 art. p 92 x l 117 x h 38	ON/OFF 1 - 5 art. p 115 x l 140 x h 50	ON/OFF 1 - 15 art. p 150 x l 60 x h 35	0/1-10V 1 - 15 art. p 150 x l 60 x h 35	DALI 1 - 12 art. p 191 x l 63 x h 38

Boîtier d'encastrement Pag. 529

Boîtier d'encastrement

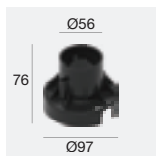

description	type
99650 Boîtiers d'encastrement	PVC
suitable for: Orma_AM 4W / Orma_AM 5W / Orma_IM 4W / Orma_IM 5W	



description	type
99651 Boîtiers d'encastrement	PVC
suitable for: Orma_AM 8W / Orma_AM 9W / Orma_IM 8W / Orma_IM 9W	



description	type
99652 Boîtiers d'encastrement	PVC
suitable for: Orma_AM 12W / Orma_AM 13W / Orma_IM 12W / Orma_IM 13W	

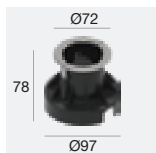

description	type
99560 Boîtiers d'encastrement	PVC
suitable for: Orma_AM 4W / Orma_AM 5W	

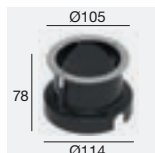

description	type
99563 Boîtiers d'encastrement	PVC
suitable for: Orma_AM 8W / Orma_AM 9W	



description	type
99564 Boîtiers d'encastrement	PVC
suitable for: Orma_AM 12W / Orma_AM 13W	



description	type
99855 Boîtiers d'encastrement	PVC
suitable for: Orma_AM 4W / Orma_AM 5W	



description	type
99856 Boîtiers d'encastrement	PVC
suitable for: Orma_AM 8W / Orma_AM 9W	



description	type
99857 Boîtiers d'encastrement	PVC
suitable for: Orma_AM 12W / Orma_AM 13W	

Optique Half Moon

Optique conçu pour une installation encastrée au mur et au sol. Ce système vous permet de créer des chemins de lumière parfaitement signalés et visibles. L'optique Moon vous permet de définir parfaitement le cône de lumière au profit d'un confort visuel élevé et en plus d'être facilement réglable pour vous permettre de l'installer où vous voulez.

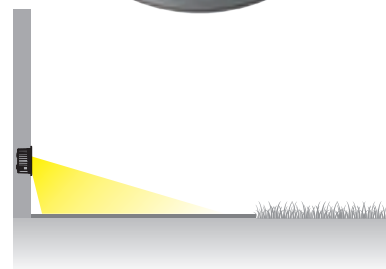
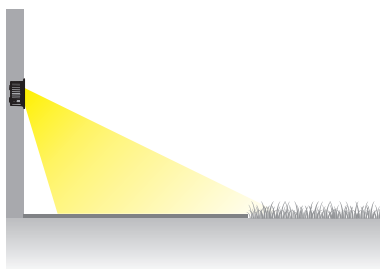
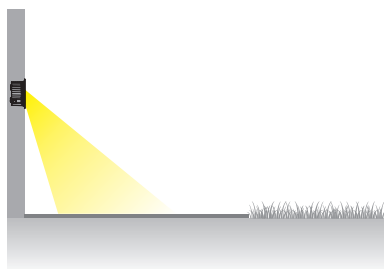

Grâce au système à basculement intégré dans la cage optique, Orma Half Moon s'adapte à différentes hauteurs d'installation et diffuse la lumière jusqu'à 3 mètres de la source.



step

Matériaux
Corps en aluminium

Step66 | Path-marker | powerLED 1 W DC 350 mA

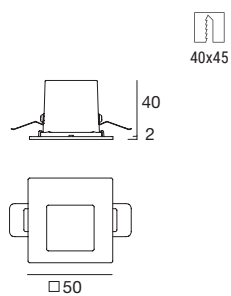

Efficiency	Cct	lm S - D	Optic
Chrome 82741	M 2700	136 - On req	07 Asymm. -
White 82742	W 3000	145 - On req	
Grey 82743	N 4000	159 - On req	
DarkBrown 82744			

Électronique

89419	89421	99183	83100
ON/OFF 1 - 2 art. p 65 x l 74 x h 27	ON/OFF 3 - 6 art. p 65 x l 74 x h 27	ON/OFF 6 - 12 art. p 80 x l 100 x h 31	DALI 1 - 14 art. p 54 x l 121 x h 26

Boîtier d'encastrement Pag. 531

Step66 | Path-marker | 190-250 V AC | powerLED 1 W DC - 1,2 W AC

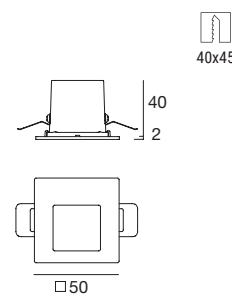

Efficiency	Cct	lm S - D	Optic
Chrome 82745	M 2700	136 - On req	07 Asymm. -
White 82746	W 3000	145 - On req	
Grey 82747	N 4000	159 - On req	
DarkBrown 82748			

RTG 82746W07 / 82748W07

Boîtier d'encastrement Pag. 531

Boîtier d'encastrement

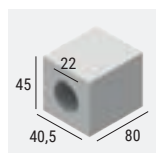

description

83181	Template
suitable for: Step66 1W / Step66 1,2W	

Wall path markers



chim

Matériaux

Corps en nylon

Bride en inox AISI 316L

Chim | Path-marker | 190-250 V AC | powerLED 4 W DC - 4,8 W AC

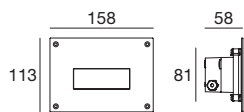

		Cct	Im S - D	Optic
Steel	92681	M 2700	438 - On req	12 E.W.Flood(107°)
		W 3000	466 - 316	
		N 4000	498 - 337	

Boîtier d'encastrement Pag. 533

RTG 92681W12

Boîtier d'encastrement

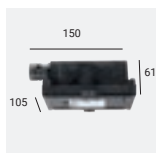

	description
98009	Boîtier d'encastrement
suitable for: Chim 4W	

Private apartments | Jesolo, Italy

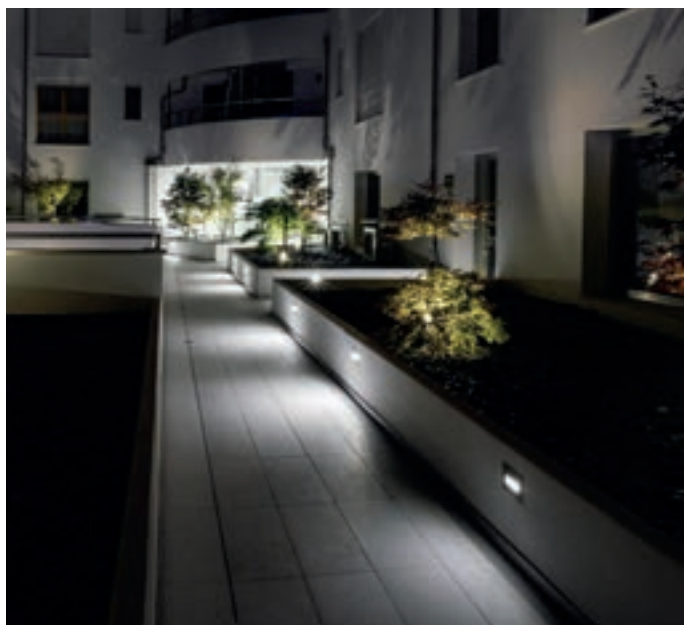



quara

Matériaux

Corps en aluminium
ou inox AISI 316L



Quara_R | Path-marker | powerLED 2 W DC 630 mA



52

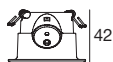

		Cct	lm S - D	Optic
White	85543	M 2700	219 - 109	70 E.W.Flood(104°)
Grey	85542	W 3000	233 - 133	
DarkBrown	87988	N 4000	249 - 142	
Sand	82512			

Électronique

89420	99179	99186	83102
ON/OFF 1 - 2 art. p 65 x l 74 x h 27	ON/OFF 3 - 6 art. p 80 x l 100 x h 31	ON/OFF 6 - 12 art. p 92 x l 117 x h 38	DALI 1 - 14 art. p 54 x l 121 x h 26

Boîtier d'encastrement Pag. 539

RTG 85543W70 / 85543N70 / 85542W70 / 87988W70

Quara_R | Path-marker | 190-250 V AC | powerLED 2 W DC



52



		Cct	lm S - D	Optic
White	83579	M 2700	219 - 109	70 E.W.Flood(104°)
Grey	83580	W 3000	233 - 133	
DarkBrown	83581	N 4000	249 - 142	

Boîtier d'encastrement Pag. 539

RTG 83579W70 / 83580W70 / 83581W70

Quara_R | Path-marker | 24 V DC | powerLED 1,5 W DC



29

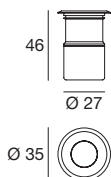

		Cct	lm S - D	Optic
Steel	84075	M 2700	219 - 109	70 E.W.Flood-
DarkBrown	84076	W 3000	233 - 133	
Brass	84077	N 4000	249 - 142	

Électronique

89488	89179	89359	99332	99722
ON/OFF 1 - 9 art. p 80 x l 100 x h 31	ON/OFF 1 - 15 art. p 92 x l 117 x h 38	ON/OFF 1 - 30 art. p 115 x l 140 x h 50	0/1-10V 1 - 98 art. p 150 x l 160 x h 35	DALI 1 - 78 art. p 191 x l 63 x h 38

Boîtier d'encastrement Pag. 539

Quara_RI | Path-marker | powerLED 2 W DC 630 mA



52

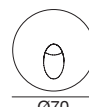

		Cct	lm S - D	Optic
Steel	92671	M 2700	219 - On req	70 W.Flood (74°)
		W 3000	233 - 133	
		N 4000	249 - 142	

Électronique

89420	99179	99186	83102
ON/OFF 1 - 2 art. p 65 x l 74 x h 27	ON/OFF 3 - 6 art. p 80 x l 100 x h 31	ON/OFF 6 - 12 art. p 92 x l 117 x h 38	DALI 1 - 14 art. p 54 x l 121 x h 26

Boîtier d'encastrement Pag. 539

RTG 92671W70

Quara_F | Path-marker | powerLED 1 W DC 350 mA

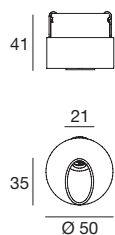

		Cct	Im S - D	Optic
White	86460	M 2700	136 - 77	70 Flood (74°)
		W 3000	145 - 83	
		N 4000	155 - 88	

Électronique

89419	89421	99183	83100
ON/OFF 1 - 2 art. p 65 x l 74 x h 27	ON/OFF 3 - 6 art. p 65 x l 74 x h 27	ON/OFF 6 - 12 art. p 80 x l 100 x h 31	DALI 1 - 14 art. p 54 x l 121 x h 26

Boîtier d'encastrement Pag. 539

RTG 86460M70 / 86460W70 / 86460N70

Quara_F | Path-marker | powerLED 0,7 W DC 220 mA



		Cct	Im S - D	Optic
White	84078	M 2700	66 - On req.	70 Flood -
		W 3000	71 - On req.	
		N 4000	76 - On req.	

Électronique

99328	99329	99342	83154
ON/OFF 1 - 2 art. p 65 x l 74 x h 27	ON/OFF 3 - 6 art. p 65 x l 74 x h 27	ON/OFF 6 - 12 art. p 80 x l 100 x h 31	DALI 5 - 14 art. p 54 x l 121 x h 26

Boîtier d'encastrement Pag. 539

Quara_Q | Path-marker | powerLED 2 W DC 630 mA

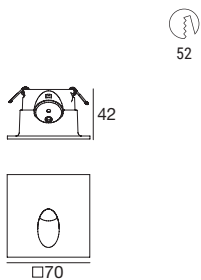

52

		Cct	Im S - D	Optic
White	86563	M 2700	219 - On req	70 E.W.Flood(104°)
Grey	86562	W 3000	233 - 104	
DarkBrown	87989	N 4000	249 - 112	
Sand	82513			

Électronique

89420	99179	99186	83102
ON/OFF 1 - 2 art. p 65 x l 74 x h 27	ON/OFF 3 - 6 art. p 80 x l 100 x h 31	ON/OFF 6 - 12 art. p 92 x l 117 x h 38	DALI 1 - 14 art. p 54 x l 121 x h 26

Boîtier d'encastrement Pag. 539

RTG 86563W70 / 86563N70 / 86562W70 / 87989W70

Quara_Q | Path-marker | 190-250 V AC | powerLED 2 W DC

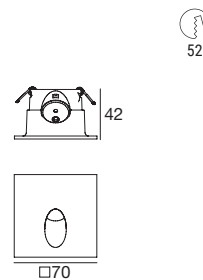

52

		Cct	Im S - D	Optic
White	83583	M 2700	219 - On req	70 E.W.Flood(104°)
Grey	83584	W 3000	233 - 104	
DarkBrown	83585	N 4000	249 - 112	

Boîtier d'encastrement Pag. 539

RTG 83583W70 / 83584W70 / 83585W70

Quara_QI | Path-marker | powerLED 2 W DC 630 mA

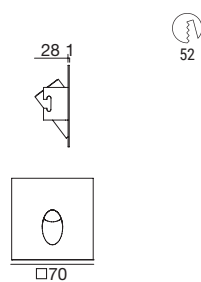

52

		Cct	Im S - D	Optic
Steel	92672	M 2700	219 - On req	70 W.Flood (74°)
		W 3000	233 - 84	
		N 4000	249 - 90	

Électronique

89420	99179	99186	83102
ON/OFF 1 - 2 art. p 65 x l 74 x h 27	ON/OFF 3 - 6 art. p 80 x l 100 x h 31	ON/OFF 6 - 12 art. p 92 x l 117 x h 38	DALI 1 - 14 art. p 54 x l 121 x h 26

Boîtier d'encastrement Pag. 539

RTG 92672W70

Quara_QI | Path-marker | 198-264 V AC | powerLED 4 W DC - 4,8 W AC

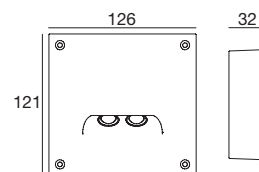

		Cct	Im S - D	Optic
White	92238	M 2700	438 - On req	70 W.Flood (75°)
Grey	92239	W 3000	466 - 267	
DarkBrown	92240	N 4000	498 - 285	
Sand	82514			

Boîtier d'encastrement Pag. 539

RTG 92238W70 / 92239W70 / 92240W70

Boîtier d'encastrement

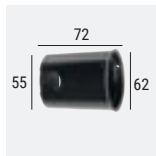

	description	type
84338	Boîtier d'encastrement	PVC
suitable for: Quara_R 2W / Quara_RI 2W Quara_F 1W / Quara_Q 2W / Quara_QI 2W		



	description	type
98050	Boîtier d'encastrement	PVC
suitable for: Quara_QI 4W		



	description	type
83155	Boîtier d'encastrement	PVC
suitable for: Quara_F 0,7W		



cut

Matériaux
Corps en aluminium

Cut_R | Path-marker | powerLED 2 W DC 630 mA



52

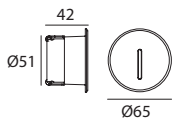

		Cct	lm S - D	Optic
White	92513	M 2700	219 - On req	05 Flood (35°)
Grey	92514	W 3000	233 - 26	
		N 4000	249 - 27	

Électronique

89420	99179	99186	83102
ON/OFF 1 - 2 art. p 65 x l 74 x h 27	ON/OFF 3 - 6 art. p 80 x l 100 x h 31	ON/OFF 6 - 12 art. p 92 x l 117 x h 38	DALI 1 - 14 art. p 54 x l 121 x h 26

Cut_Q | Path-marker | powerLED 2 W DC 630 mA



52

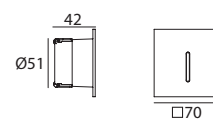

		Cct	lm S - D	Optic
White	92558	M 2700	219 - On req	05 Flood (35°)
Grey	92559	W 3000	233 - 131	
		N 4000	249 - 139	

Électronique

89420	99179	99186	83102
ON/OFF 1 - 2 art. p 65 x l 74 x h 27	ON/OFF 3 - 6 art. p 80 x l 100 x h 31	ON/OFF 6 - 12 art. p 92 x l 117 x h 38	DALI 1 - 14 art. p 54 x l 121 x h 26

RTG 92558W05

Almar Hotel | Jesolo, Italy



Boîtier d'encastrement

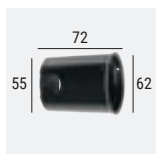

description	type
84338 Boîtier d'encastrement	PVC

suitable for: Cut_R 2W / Cut_Q 2W

Wall path markers

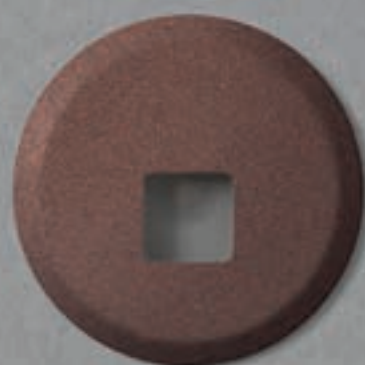

clip

Matériaux
Corps en aluminium

Clip | Wall-path markers | powerLED 1 W DC 350 mA



		Cct	lm S - D	Optic
White	82707	M 2700	136 - On req	07 Asymm. -
Grey	82708	W 3000	145 - On req	
DarkBrown	82709	N 4000	155 - On req	

Électronique

89419	89421	99183	83100
ON/OFF 1 - 2 art. p 65 x l 74 x h 27	ON/OFF 3 - 6 art. p 65 x l 74 x h 27	ON/OFF 6 - 12 art. p 80 x l 100 x h 31	DALI 1 - 14 art. p 54 x l 121 x h 26

Clip | Wall-path markers | powerLED 1 W DC 350 mA



		Cct	lm S - D	Optic
White	82704	M 2700	136 - On req	07 Asymm. -
Grey	82705	W 3000	145 - On req	
DarkBrown	82706	N 4000	155 - On req	

Électronique

89419	89421	99183	83100
ON/OFF 1 - 2 art. p 65 x l 74 x h 27	ON/OFF 3 - 6 art. p 65 x l 74 x h 27	ON/OFF 6 - 12 art. p 80 x l 100 x h 31	DALI 1 - 14 art. p 54 x l 121 x h 26

Clip_Hm | Wall-path markers | powerLED 1 W DC 350 mA



		Cct	lm S - D	Optic
White	82701	M 2700	136 - On req	07 Asymm. -
Grey	82702	W 3000	145 - On req	
DarkBrown	82703	N 4000	155 - On req	

Électronique

89419	89421	99183	83100
ON/OFF 1 - 2 art. p 65 x l 74 x h 27	ON/OFF 3 - 6 art. p 65 x l 74 x h 27	ON/OFF 6 - 12 art. p 80 x l 100 x h 31	DALI 1 - 14 art. p 54 x l 121 x h 26

Clip_Hm | Wall-path markers | powerLED 1 W DC 350 mA



		Cct	lm S - D	Optic
Steel	82710	M 2700 W 3000 N 4000	136 - On req 145 - On req 155 - On req	07 Asymm. -

Électronique

89419	89421	99183	83100
ON/OFF 1 - 2 art. p 65 x l 74 x h 27	ON/OFF 3 - 6 art. p 65 x l 74 x h 27	ON/OFF 6 - 12 art. p 80 x l 100 x h 31	DALI 1 - 14 art. p 54 x l 121 x h 26

Clip_R | Wall light | powerLED 2 W DC 630 mA

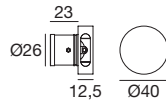

	Cct	Im S - D	Optic
White 92271	W 3000	219 - On req	70 E.W.Flood (92°)
Grey 92272	N 4000	233 - On req	
Steel 92273	C 5000	249 - On req	
R - G - B - Y on request			

Électronique

89420	99179	99186	83102
ON/OFF 1 - 2 art. p 65 x l 74 x h 27	ON/OFF 3 - 6 art. p 80 x l 100 x h 31	ON/OFF 6 - 12 art. p 92 x l 117 x h 38	DALI 1 - 14 art. p 54 x l 121 x h 26

Boîtier d'encastrement Pag. 545

Clip_R | Wall light | powerLED 2 W DC 350 mA

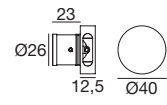

	Cct	Im S - D	Optic
White 92281	W 3000	219 - On req	70 E.W.Flood (92°)
Grey 92282	N 4000	233 - On req	
Steel 92283	C 5000	249 - On req	
R - G - B - Y on request			

Électronique

89419	89421	99183	83100
ON/OFF 1 art. p 66 x l 74 x h 27	ON/OFF 2 - 3 art. p 66 x l 74 x h 27	ON/OFF 3 - 6 art. p 80 x l 100 x h 31	DALI 1 - 7 art. p 54 x l 122 x h 26

Boîtier d'encastrement Pag. 545

Clip_X | Wall light | powerLED 2 W DC 630 mA

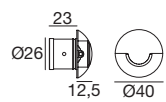

	Cct	Im S - D	Optic
White 92311	W 3000	219 - On req	70 W.Flood (123°)
Grey 92312	N 4000	233 - On req	
Steel 92313	C 5000	249 - On req	
R - G - B - Y on request			

Électronique

89420	99179	99186	83102
ON/OFF 1 - 2 art. p 65 x l 74 x h 27	ON/OFF 3 - 6 art. p 80 x l 100 x h 31	ON/OFF 6 - 12 art. p 92 x l 117 x h 38	DALI 1 - 14 art. p 54 x l 121 x h 26

Boîtier d'encastrement Pag. 545

Clip_Q | Wall light | powerLED 2 W DC 630 mA

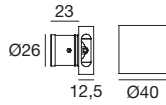

		Cct	Im S - D	Optic
White	92291	W 3000	219 - On req	70 E.W.Flood (92°)
Grey	92292	N 4000	233 - On req	
Steel	92293	C 5000	249 - On req	
R - G - B - Y on request				

Électronique

89420	99179	99186	83102
ON/OFF 1 - 2 art. p 65 x l 74 x h 27	ON/OFF 3 - 6 art. p 80 x l 100 x h 31	ON/OFF 6 - 12 art. p 92 x l 117 x h 38	DALI 1 - 14 art. p 54 x l 121 x h 26

Boîtier d'encastrement Pag. 545

Clip_Q | Wall light | powerLED 2 W DC 350 mA

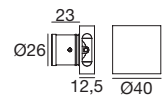

		Cct	Im S - D	Optic
White	92301	W 3000	219 - On req	70 E.W.Flood (123°)
Grey	92302	N 4000	233 - On req	
Steel	92303	C 5000	249 - On req	
R - G - B - Y on request				

Électronique

89419	89421	99183	83100
ON/OFF 1 art. p 66 x l 74 x h 27	ON/OFF 2 - 3 art. p 66 x l 74 x h 27	ON/OFF 3 - 6 art. p 80 x l 100 x h 31	DALI 1 - 7 art. p 54 x l 122 x h 26

Boîtier d'encastrement Pag. 545

Boîtier d'encastrement

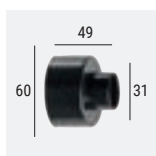

	description	type
84915	Boîtier d'encastrement	PVC
suitable for: Clip / Clip_Hm / Clip_R / Clip_X / Clip_Q		

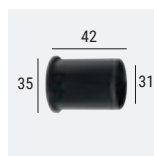

	description	type
84336	Boîtier d'encastrement	PVC
suitable for: Clip / Clip_Hm / Clip_R / Clip_X / Clip_Q		



sand

Matériaux

Corps en laiton

Diffuseur en polycarbonate opalin

Sand_R | Path-marker | powerLED 1 W DC 350 mA

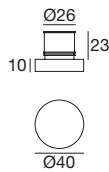

	Cct	lm S - D	Optic
White 92260	W 3000	136 - 85	00 General (180°)
	N 4000	145 - 90	
	C 5000	155 - 103	
	B Blue		
	R - G - Y on request		

Électronique

89419	89421	99183	83100
ON/OFF 1 - 2 art. p 65 x l 74 x h 27	ON/OFF 3 - 6 art. p 65 x l 74 x h 27	ON/OFF 6 - 12 art. p 80 x l 100 x h 31	DALI 1 - 14 art. p 54 x l 121 x h 26

RTG 92260W00

Sand_Q | Path-marker | powerLED 1 W DC 350 mA

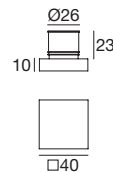

	Cct	lm S - D	Optic
White 92262	W 3000	136 - 85	00 General (180°)
	N 4000	145 - 90	
	C 5000	155 - 103	
	B Blue		
	R - G - Y on request		

Électronique

89419	89421	99183	83100
ON/OFF 1 - 2 art. p 65 x l 74 x h 27	ON/OFF 3 - 6 art. p 65 x l 74 x h 27	ON/OFF 6 - 12 art. p 80 x l 100 x h 31	DALI 1 - 14 art. p 54 x l 121 x h 26

RTG 92262W00

Boîtier d'encastement

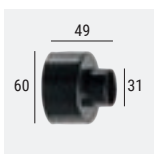

description	type
84915 Boîtier d'encastement	PVC
suitable for: Sand_R / Sand_Q	

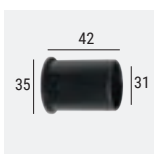

description	type
84336 Boîtier d'encastement	PVC
suitable for: Sand_R / Sand_Q	





Uplights

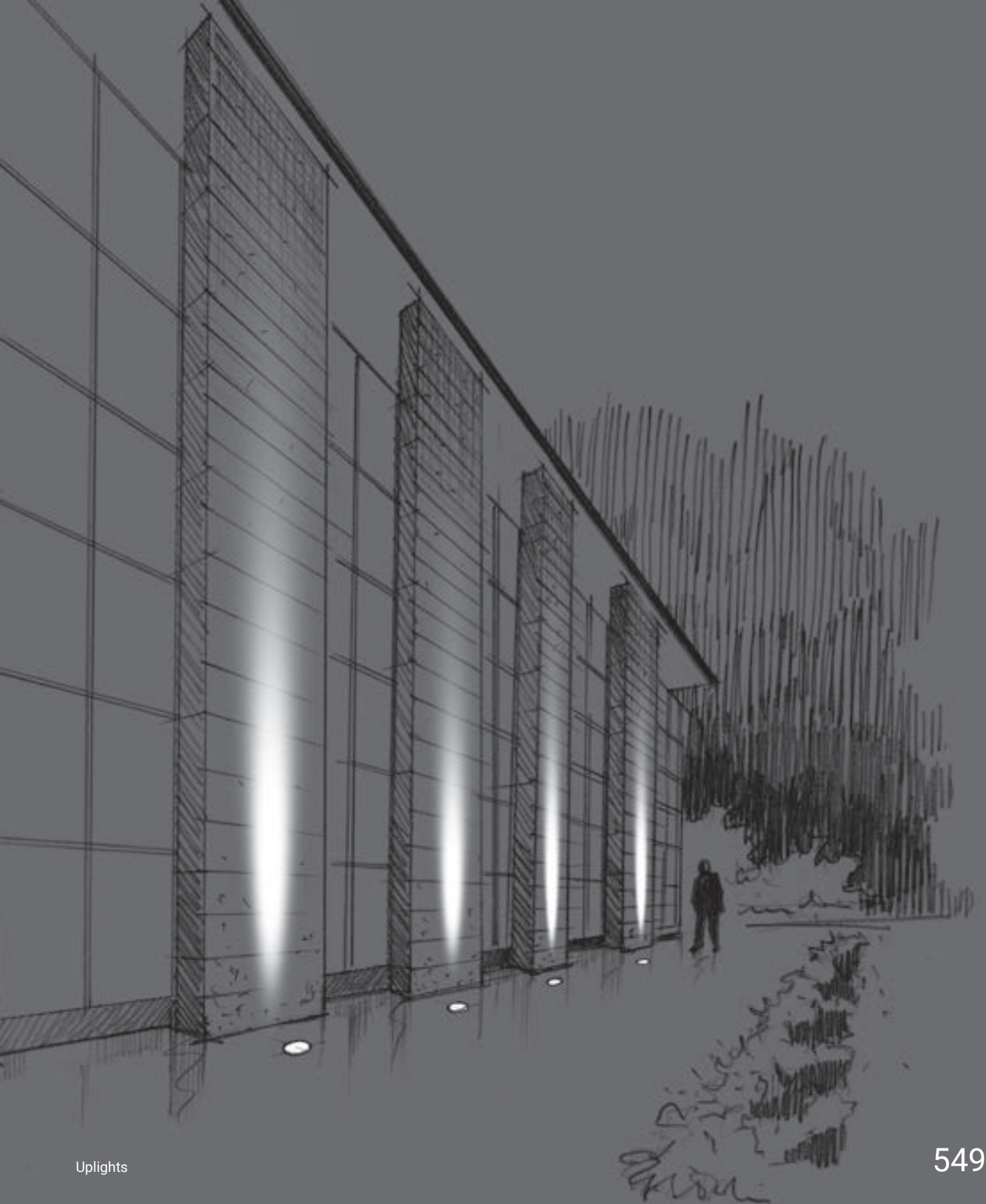

uplights and in-ground lamps range index

Suelo

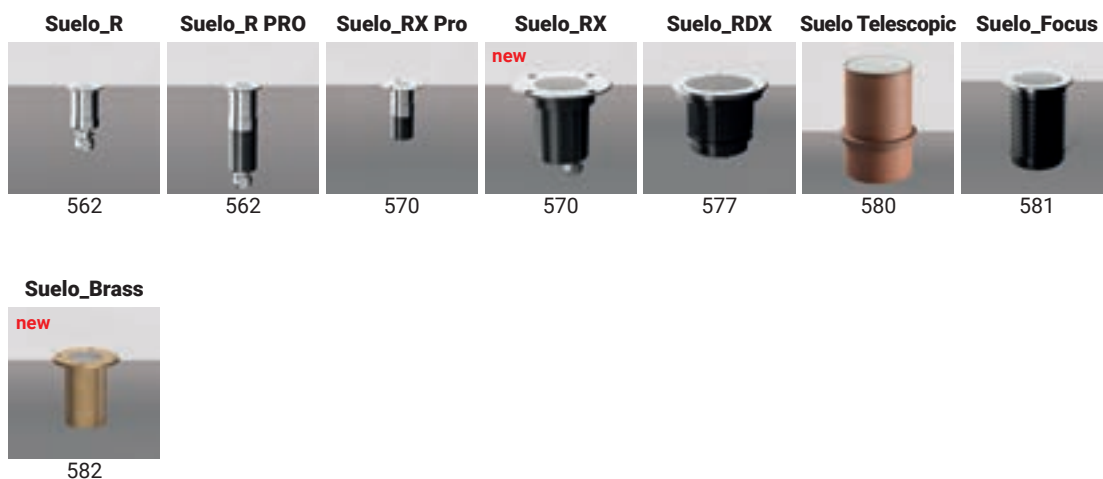

Orma

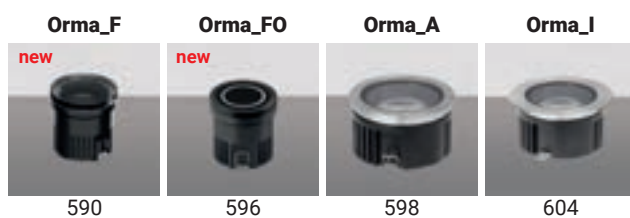

Beret



Zalex



Fasim



Concentrica



Alcor



Astropek



Footpad

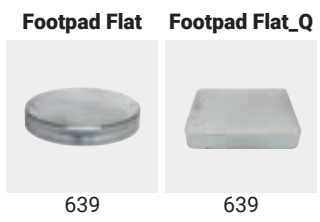





uplights and in-ground lamps

Évolution technique

Les nouvelles familles de luminaires à encastrement au sol ont bénéficié de l'utilisation de matériaux de haute qualité tels que l'aluminium pour le corps, l'inox AISI 316 pour la bride (idéal pour la durabilité dans les environnements à haut degré de salinité) et le verre trempé pour le bloc optique, ainsi que d'une miniaturisation des composants. Ces améliorations ont joué un rôle clé dans le processus de développement technique qui permet, à ce jour, aux uplights de la collection Linea Light Group de satisfaire tous les besoins en matière d'éclairage.



Résistance au passage de véhicules

L'utilisation de matériaux mécaniquement très résistants, ainsi que l'étude du logement du boîtier d'encastrement spécifique à chaque famille garantissent une capacité de charge allant jusqu'à 5 000 kg.



Systèmes de sécurité

Nous avons développé plusieurs systèmes de sécurité spécifiques pour garantir la résistance des uplights à la corrosion et leur durabilité. Systèmes de protection contre les surtensions (OVP) et contre les décharges électrostatiques (ESD). Systèmes de protection de l'intégrité des circuits contre la formation d'humidité (TCS®) et de l'eau de condensation à l'intérieur du corps étanche (AquaStop®).



OVP



TCS system



IP68

L'union du savoir-faire technique, de l'utilisation des matériaux les plus adaptés et l'adoption de systèmes de sécurité avancés garantit un degré réel de protection IP68 : le produit est entièrement protégé contre la pénétration de poussière et de particules solides, contre les jets d'eau et une immersion totale de courte durée.



Qualité durable

Les produits Linea Light Group avec source topLED garantissent une durée de vie de plus de 72 000 heures ! Attention, cela ne signifie pas que, une fois la durée de vie estimée écoulee, les LED s'éteignent, mais seulement qu'elles atteignent 70% du flux lumineux initial avec une fiabilité de 90% du respect du paramètre. Les données estimées relatives aux modules arrayLED et powerLED sont encore plus impressionnantes : la durée de vie garantie par les nombreux tests auxquels ils sont soumis dépasse les 223 000 heures ! Le tout est couronné par un taux de panne nul.



LED i-LED B10
90% de fiabilité
du paramètre L

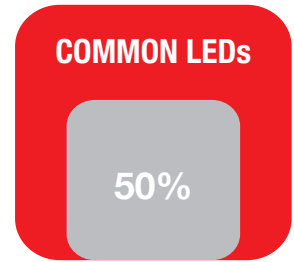

LEDs communes sur le marché B50
50% de fiabilité
du paramètre L

Step MacAdam <2

Afin d'assurer l'uniformité des couleurs non seulement dans le temps, mais également entre différents produits d'un même projet d'éclairage, nous avons sélectionné les meilleurs fabricants de LED pour garantir une sélection constante et répétitive de LED.



i-LED MacAdam < 2

MacAdam <2 est pour nous un standard de qualité : la valeur 2 signifie que la différence est invisible à l'œil nu et que les LED sont considérées comme étant d'excellente qualité.



Inhomogénéité chromatique - competitors

Gamme de couleurs

Avec Linea Light Group, le concepteur dispose d'une large gamme de températures de couleur, allant du blanc chaud (2700 K) aux tons correspondant à une lumière naturelle (5000 K), pour une polyvalence totale lors de la conception. La lumière blanche est accompagnée de l'offre RGB pour des effets de lumière colorés statiques ou

dynamiques. L'introduction du système RGBW (blanc séparé des trois couleurs RGB à l'intérieur de la diode) offre une possibilité supplémentaire au concepteur qui peut compter aussi bien sur un meilleur mélange des couleurs pour ses mises en scène que sur une lumière blanche pure.

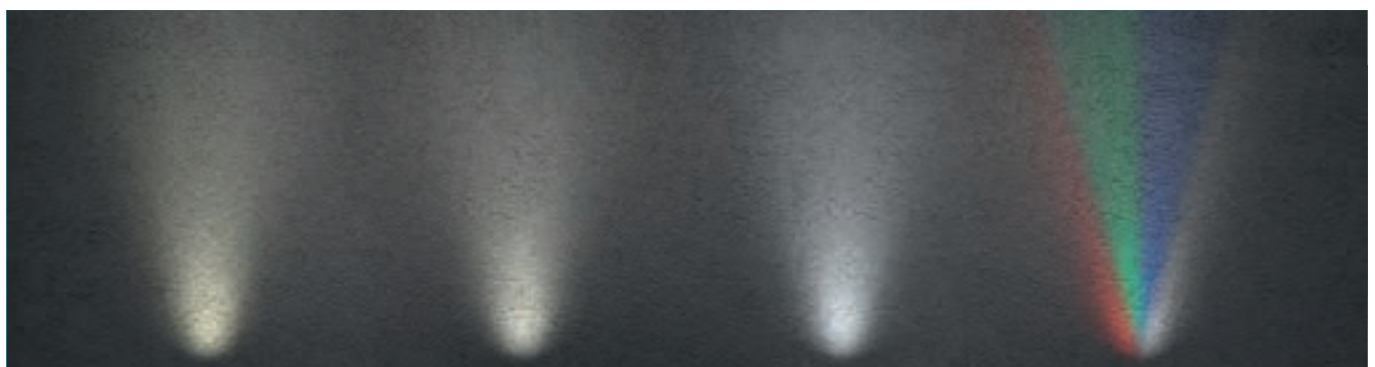

2700° K

3000° K

4000° K

RGBW

uplights and in-ground comfort



Optiques standard et professionnelles

La structure des luminaires à encastrement Linea Light Group est conçue pour offrir l'option d'un positionnement en retrait de la source, en alternative à la solution standard. La plus grande profondeur de la source assure un confort supplémentaire grâce à l'augmentation de l'angle de masquage, entraînant ainsi un meilleur confort visuel.

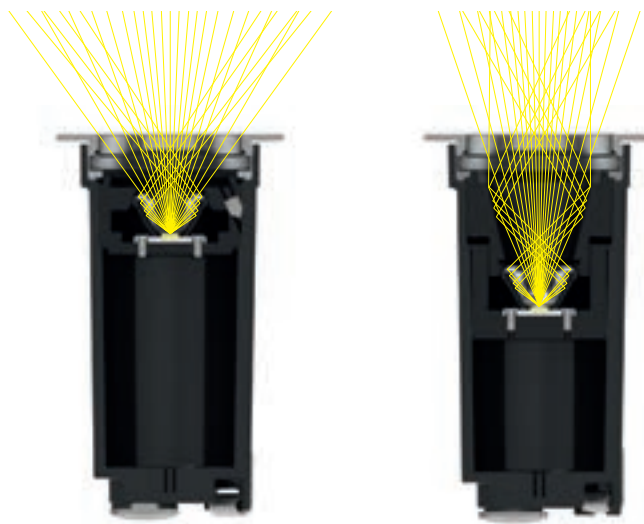

Honeycomb



Les microalvéoles hexagonales qui composent la grille en nid d'abeilles du filtre Honeycomb aident à masquer le faisceau lumineux, permettant ainsi de réduire l'éblouissement direct tout en maintenant une émission diffuse de qualité inaltérée.



Avec Honeycomb

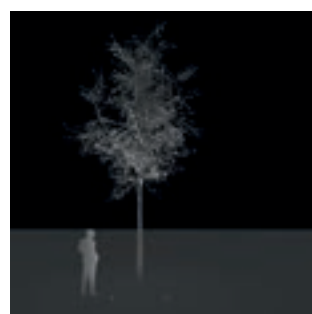
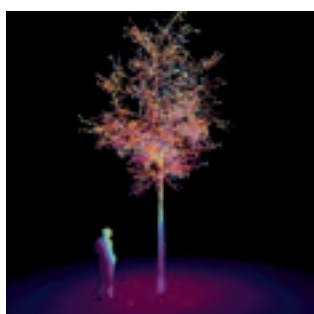

Sans Honeycomb



Darklight



Dans le cas d'un éclairage rasant, le filtre darklight permet de couper le faisceau pour ne conserver que la partie utile de celui-ci, à savoir celle qui est uniquement dirigée vers la surface à éclairer, limitant ainsi l'éblouissement direct y compris à proximité de la source.



Avec Darklight

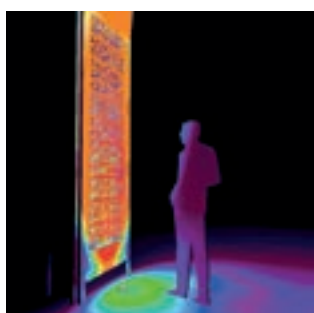

Sans Darklight

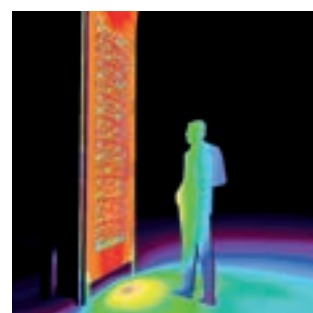

uplights and in-ground optic range

Optiques étroites



Narrow Spot



Spot



Spot

Optiques moyennes



Flood

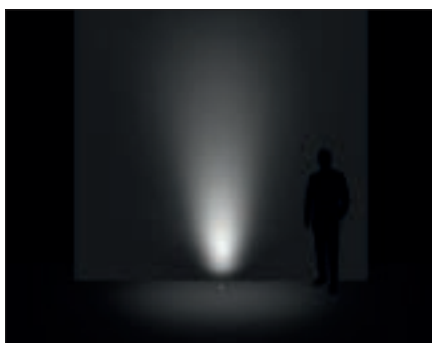

Medium Flood

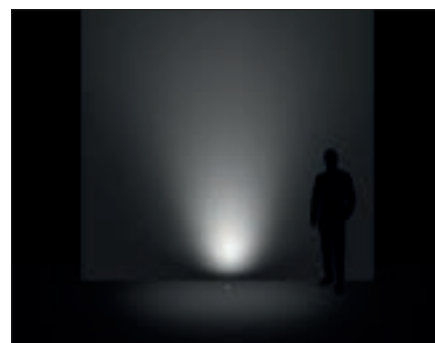

Medium Flood

Optiques diffuses

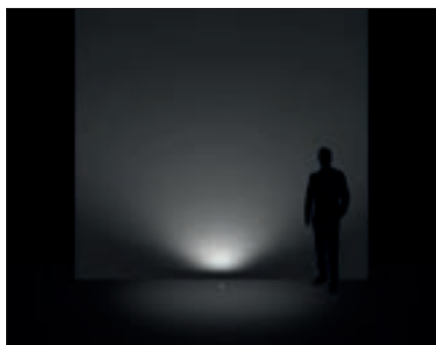

Wide Flood

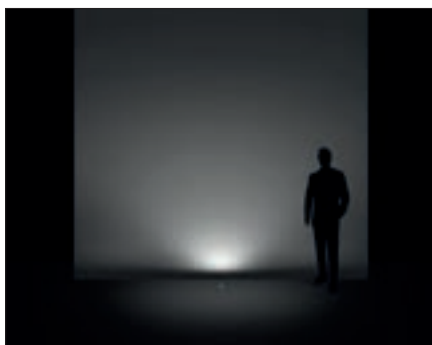

General

Optiques pour éclairage lèche-mur

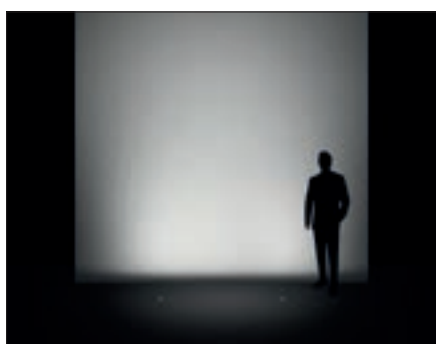

Asymmetric Wall Washer

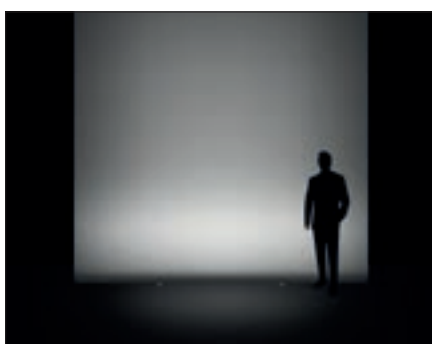

Elliptic

suelo

Matériaux

Corps en aluminium

Corps en laiton

Bride en inox AISI 316L

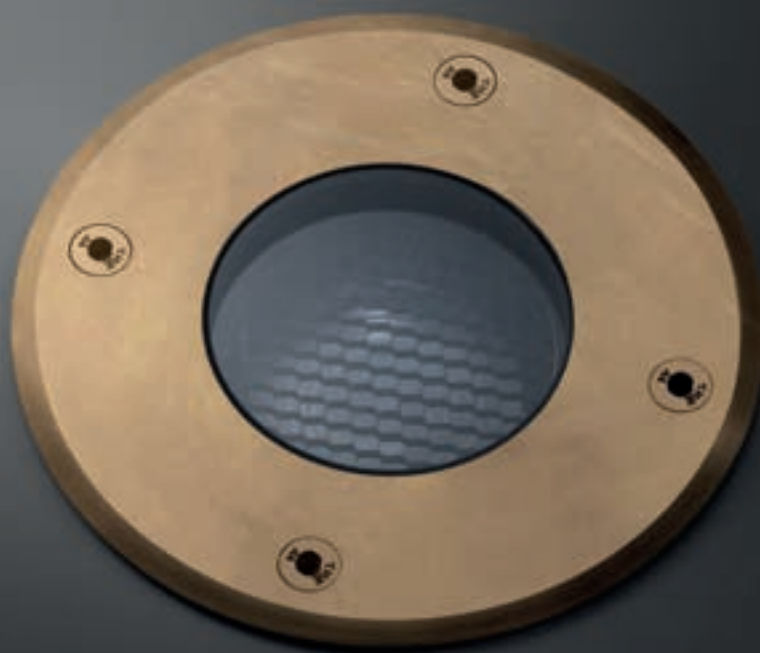

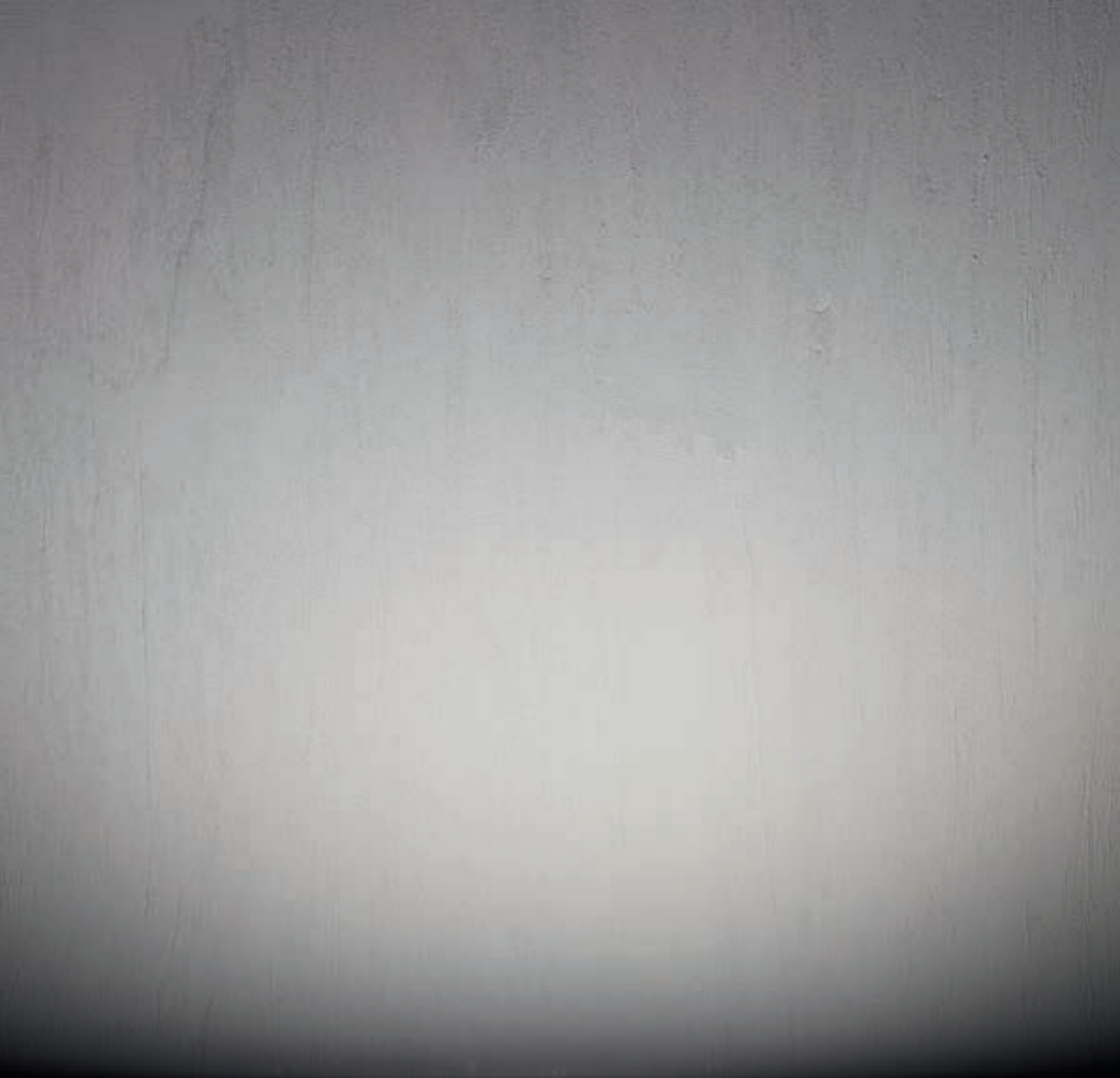

suelo range



	Suelo_R Round Suelo_RJ Round adjustable	Suelo_R PRO Round Suelo_RJ PRO Round adjustable	Suelo Focus Round Suelo_I Focus Round	Suelo_RX PRO Round adjustable with screws	Suelo Brass Round with screws	Suelo_RX Round Suelo_RXJ Round adjustable	Suelo_RDX Double optics adjustable	Suelo_RF Round Suelo_RFJ Round adjustable	Suelo Telescopic
1W - 1,5W	Ø 25 mm	Ø 25 mm	-	-	-	-	-	-	-
2W - 2,5W	Ø 30 mm	Ø 35 mm	-	Ø 50 mm	-	-	-	-	-
4W - 5W	Ø 64 mm (RJ) Ø 64 mm	Ø 64 mm	-	-	-	-	-	-	-
8W - 9W	Ø 92 mm	Ø 92 mm (RJ PRO) Ø 92 mm	Ø 97 mm Ø 85 mm	Ø 120 mm	Ø 120 mm	Ø 120 mm (RXJ) Ø 120 mm	-	-	-
12W	-	-	-	-	-	-	Ø 170 mm	-	Ø 200 mm
13W	-	-	-	Ø 170 mm	-	Ø 170 mm (RXJ) Ø 170 mm	-	-	-
24W - 26W	-	-	-	-	-	Ø 232 mm	Ø 232 mm	-	Ø 200 mm
30W	-	-	-	-	-	Ø 232 mm (RXJ) Ø 232 mm	-	-	-
37W - 44,2W	-	-	-	-	-	Ø 315 mm (RXJ) Ø 315 mm	-	Ø 308 mm (RFJ) Ø 308 mm	-
Finish	Steel Steel/Alu Steel/Br Brass/Alu	Steel Steel/Alu Steel/Br Brass/Alu	Steel/Alu	Steel/Alu Brass/Alu	Brass	Steel/Alu Brass/Alu	Steel/Alu	Steel/Alu	DarkBrown
Accessories	HC	HC DL	-	HC DL	HC	HC DL	-	HC DL	-
Cct	2700K 3000K 4000K RGBW	2700K 3000K 4000K	2700K 3000K 4000K	2700K 3000K 4000K	2700K 3000K 4000K	2700K 3000K 4000K RGBW	2700K 3000K 4000K	2700K 3000K 4000K RGBW	2700K 3000K 4000K
Optics	N.Spot Spot Flood W.Flood Elliptic E.W.Flood General Asymm.	N.Spot Spot Flood W.Flood	Adjustable	N.Spot Spot Flood W.Flood	N.Spot Spot Flood W.Flood	N.Spot Spot Flood W.Flood Elliptic E.W.Flood General Asymm.	Spot Flood W.Flood	Spot Flood W.Flood	Spot Flood W.Flood
Driver 	On/Off 0/1-10V DALI - DMX	On/Off 0/1-10V DALI	-	On/Off 0/1-10V DALI	-	On/Off 0/1-10V DALI - DMX	-	-	-
Driver 	On/Off	On/Off	On/Off	On/Off	On/Off	On/Off DALI	On/Off	On/Off DALI - DMX	On/Off
Current	C.C. C.V.	C.C. C.V.	-	C.C. C.V.	-	C.C. C.V.	-	-	-

Largeur de gamme

La famille Suelo offre une grande variété de solutions pour répondre à toutes les exigences en matière de conception : versions fixes ou orientables ; uplight avec bride réduite pour une installation affleurante ; luminaires à réglage variable via protocole DALI ; modèles PRO avec optiques en retrait et modèles avec source RGBW, et filtres de contrôle de l'émission. Toutes les versions adoptent le système de protection exclusif AquaStop® et présentent une variante avec convertisseur 24 V intégré dans le câble.

Suelo peut être équipé du filtre honeycomb qui permet de masquer la lumière secondaire et de réduire l'éblouissement direct tout en maintenant inaltérée la qualité de l'émission diffuse. Dans le cas d'un éclairage rasant, il peut également être équipé du filtre darklight qui permet de couper le faisceau pour ne conserver que la partie utile de celui-ci, limitant ainsi l'éblouissement direct y compris à proximité de la source. Pour obtenir le plein contrôle de l'émission tout en réduisant notablement le risque d'éblouissement il est conseillé de choisir les versions Suelo PRO : la source en retrait augmente l'angle de masquage, supprimant ainsi en totalité le faisceau secondaire pour favoriser une émission plus concentrée, propre et efficace.



Suelo PRO

Suelo + Honeycomb

Suelo + Dark Light

Nouvelle version de 31,5 cm de diamètre

L'évolution de la famille Suelo inclut la nouvelle version de 44,2 W d'un diamètre de 315 mm, qui augmente les performances. En complément de la gamme d'optiques qui caractérise tous les Suelo, la nouvelle version se distingue parce qu'elle est extrêmement facile à installer, avec le boîtier d'encastrement étudié pour orienter l'inclinaison dans l'axe horizontal, et sans accéder à l'intérieur de la chambre optique dans l'axe vertical (EAS™ pag 579). Suelo a été également conçu dans le but de loger le groupe d'alimentation et de commande dans le corps du produit, qui garantit un indice de protection élevé IP67.



Suelo_RX Standard

Suelo_RX 06°

Suelo_RX Dark light

Suelo_RX Honeycomb

Suelo_RF Standard

Performances et contrôle

Le professionnel peut choisir parmi neuf niveaux de puissance différents (de 1 à 44,2 W), trois températures de couleur comprenant une lumière chaude à 2700 et 3000 K ou une lumière naturelle à 4000 K, et un panorama optique inégalé permettant de nombreuses émissions différentes en fonction de la version choisie, notamment : Elliptic pour une émission ovalisée et un éclairage lèche-mur pour murs hauts et étroits, et Asymmetric pour un faisceau directionnel qui rase le mur de manière homogène.

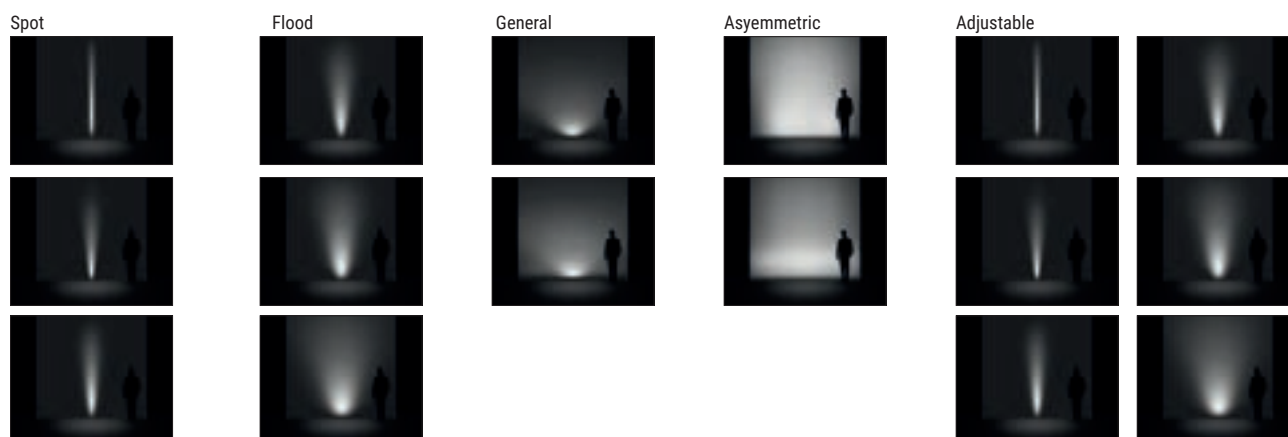

Suelo_R | Up-Light | powerLED

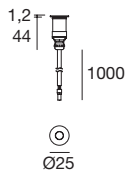

C.C. 1W DC - 350mA		Cct	lm S - D	Optic
Steel	80432	M 2700	136 - 104	20 Flood (26°)
		W 3000	145 - 111	35 Flood (36°)
		N 4000	155 - 119	

Électronique

89419	89421	99183	83100
ON/OFF 1 - 2 art. p 65 x l 74 x h 27	ON/OFF 3 - 6 art. p 65 x l 74 x h 27	ON/OFF 6 - 12 art. p 80 x l 100 x h 31	DALI 1 - 14 art. p 54 x l 121 x h 26

Boîtier d'encastrement Pag. 583

Suelo_R Pro | Up-Light | powerLED

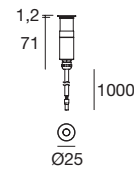

C.C. 1 W DC - 350mA		Cct	lm S - D	Optic
Steel	80433	M 2700	136 - 96	20 Spot (23°)
Steel Br	82527	W 3000	145 - 102	35 Flood (34°)
		N 4000	155 - 110	

Électronique

89419	89421	99183	83100
ON/OFF 1 - 2 art. p 65 x l 74 x h 27	ON/OFF 3 - 6 art. p 65 x l 74 x h 27	ON/OFF 6 - 12 art. p 80 x l 100 x h 31	DALI 1 - 14 art. p 54 x l 121 x h 26

C.V. 1,5W DC - 24 V DC		Cct	lm S - D	Optic
Steel	80434	M 2700	136 - 96	20 Spot (23°)
Steel Br	82528	W 3000	145 - 102	35 Flood (34°)
		N 4000	155 - 110	

Électronique

89488	89179	89359	99332	99722
ON/OFF 1 - 9 art. p 80 x l 100 x h 31	ON/OFF 1 - 15 art. p 92 x l 117 x h 38	ON/OFF 1 - 30 art. p 115 x l 140 x h 50	0/1-10V 1 - 98 art. p 150 x l 60 x h 35	DALI 1 - 78 art. p 191 x l 63 x h 38

Boîtier d'encastrement Pag. 583

Suelo_R | Up-Light | powerLED



C.C. 2W DC - 630mA	Cct	lm S - D	Optic
Chrome 93141	M 2700	219 - On Req	08 N.Spot (10°)
	W 3000	233 - 148	15 Spot (21°)
	N 4000	249 - 159	30 Flood (26°)
			60 W.Flood (56°)
			12 E.W.Flood(89°)
			00 General (104°)

Électronique

89420	99179	99186	83102
ON/OFF 1 - 2 art. p 65 x l 74 x h 27	ON/OFF 3 - 6 art. p 80 x l 100 x h 31	ON/OFF 6 - 12 art. p 92 x l 117 x h 38	DALI 1 - 14 art. p 54 x l 121 x h 26

Boîtier d'encastrement Pag. 583

RTG 93141W30

Suelo_R Pro | Up-Light | powerLED

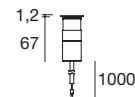

C.C. 2W DC - 630mA	Cct	lm S - D	Optic
Steel Alu 80439	M 2700	219 - 120	15 N.Spot (22°)
Brass Alu 82529	W 3000	233 - 137	30 Spot (27°)
	N 4000	249 - 147	60 Flood (52°)
			88 Elliptic -
			00 General (115°)

C.C. 2W DC - 630mA HC	Cct	lm S - D	Optic
Steel Alu 80440	M 2700	219 - 76	15 Spot (19°)
Brass Alu 82530	W 3000	233 - 85	30 Flood (25°)
	N 4000	249 - 91	60 W.Flood (44°)

Électronique

89420	99179	99186	83102
ON/OFF 1 - 2 art. p 65 x l 74 x h 27	ON/OFF 3 - 6 art. p 80 x l 100 x h 31	ON/OFF 6 - 12 art. p 92 x l 117 x h 38	DALI 1 - 14 art. p 54 x l 121 x h 26

C.V. 2,5W DC - 24 V DC	Cct	lm S - D	Optic
Steel Alu 80441	M 2700	219 - 120	15 N.Spot (22°)
Brass Alu 82531	W 3000	233 - 137	30 Spot (27°)
	N 4000	249 - 147	60 Flood (52°)
			88 Elliptic -
			00 General (115°)

C.V. 2,5 W DC - 24 V DC HC	Cct	lm S - D	Optic
Steel Alu 80442	M 2700	219 - 76	15 Spot (19°)
Brass Alu 82532	W 3000	233 - 86	30 Flood (25°)
	N 4000	249 - 91	60 W.Flood (44°)

Électronique

89488	89179	89359	99332	99722
ON/OFF 1 - 5 art. p 80 x l 100 x h 31	ON/OFF 1 - 9 art. p 92 x l 117 x h 38	ON/OFF 1 - 18 art. p 115 x l 140 x h 50	0/1-10V 1 - 56 art. p 150 x l 60 x h 35	DALI 1 - 45 art. p 191 x l 63 x h 38

Boîtier d'encastrement Pag. 583

Suelo_R | Up-Light | powerLED

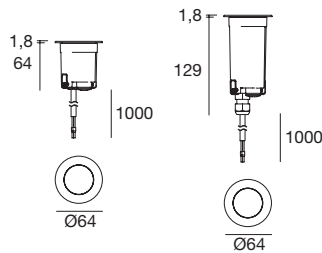
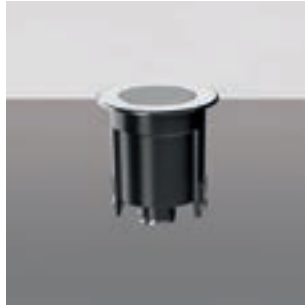

81089/81090

C.C. 4W DC - 350mA	HC	Cct	Im S - D	Optic
Steel/Alu	80443	M 2700	490 - 360	10 N.Spot (11°)
		W 3000	490 - 360	20 Spot (20°)
		N 4000	529 - 389	30 Flood (30°)
				60 W.Flood (60°)
				88 Elliptic -
				12 E.W.Flood(86°)
				00 General (116°)

C.C. 4W DC - 350mA	Cct	Im S - D	Optic
Steel/Alu	81089	M 2700	490 - 259
		W 3000	490 - 259
		N 4000	529 - 280

C.C. 4W DC - 350mA	HC	Cct	Im-S	Im-S	Optic
Steel/Alu	80444	M 2700	490 - 205		20 Spot (15°)
		W 3000	490 - 205		30 Flood (25°)
		N 4000	529 - 221		60 W.Flood (42°)

Électronique

89421	99183	83100
ON/OFF 1 art. p 65 x l 74 x h 27	ON/OFF 1 - 2 art. p 80 x l 100 x h 31	DALI 1 - 4 art. p 54 x l 121 x h 26

C.V. 5W DC - 24 V DC	HC	Cct	Im S - D	Optic
Steel/Alu	80445	M 2700	490 - 360	10 N.Spot (11°)
		W 3000	490 - 360	20 Spot (20°)
		N 4000	529 - 389	30 Flood (30°)
				60 W.Flood (60°)
				88 Elliptic -
				12 E.W.Flood(86°)
				00 General (116°)

C.V. 5W DC - 24 V DC	Cct	Im S - D	Optic
Steel/Alu	81090	M 2700	490 - 259
		W 3000	490 - 259
		N 4000	529 - 280

C.V. 5W DC - 24 V DC	HC	Cct	Im S - D	Optic
Steel/Alu	80446	M 2700	490 - 205	20 Spot (15°)
		W 3000	490 - 205	30 Flood (25°)
		N 4000	529 - 221	60 W.Flood (42°)

Électronique

89488	89179	89359	99332	99722
ON/OFF 1 - 2 art. p 80 x l 100 x h 31	ON/OFF 1 - 4 art. p 92 x l 117 x h 38	ON/OFF 1 - 9 art. p 115 x l 140 x h 50	0/1-10V 1 - 9 art. p 150 x l 60 x h 35	DALI 1 - 23 art. p 191 x l 63 x h 38

Boîtier d'encastrement Pag. 583

RTG 80443W00

564

Suelo_R | Up-Light | 198-264 V AC | powerLED 4 W DC - 5 W AC

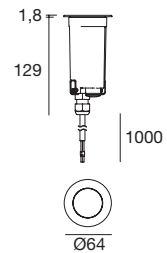

Cct	Im S - D	Optic
M 2700	490 - 360	10 N.Spot (11°)
W 3000	490 - 360	20 Spot (20°)
N 4000	529 - 389	30 Flood (30°)
		60 W.Flood (60°)
		88 Elliptic -
		12 E.W.Flood(86°)
		00 General (116°)

Cct	Im S - D	Optic
M 2700	490 - 205	20 Spot (15°)
W 3000	490 - 205	30 Flood (25°)
N 4000	529 - 221	60 Flood (42°)

Boîtier d'encastrement Pag. 583

Suelo_R Pro | Up-Light | powerLED

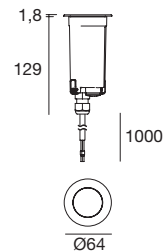

C.C. 4W DC - 350mA	Cct	Im S - D	Optic
Steel/Alu	80449	M 2700	490 - 207
C.C. 4W DC - 350mA	HC	W 3000	490 - 207
Steel/Alu	80450	N 4000	529 - 222
C.C. 4W DC - 350mA	DL	Steel/Alu	80451

Électronique

89421	99183	83100
ON/OFF 1 art. p 65 x l 74 x h 27	ON/OFF 1 - 2 art. p 80 x l 100 x h 31	DALI 1 - 4 art. p 54 x l 121 x h 26

C.V. 5W DC - 24 V DC	Cct	Im S - D	Optic
Steel/Alu	80452	M 2700	490 - 207
C.V. 5W DC - 24 V DC	HC	W 3000	490 - 207
Steel/Alu	80453	N 4000	529 - 222
C.V. 5W DC - 24 V DC	DL	Steel/Alu	80454

Électronique

89488	89179	89359	99332	99722
ON/OFF 1 - 2 art. p 80 x l 100 x h 31	ON/OFF 1 - 4 art. p 92 x l 117 x h 38	ON/OFF 1 - 9 art. p 115 x l 140 x h 50	0/1-10V 1 - 9 art. p 150 x l 60 x h 35	DALI 1 - 23 art. p 191 x l 63 x h 38

Boîtier d'encastrement Pag. 583

Suelo_RJ | Up-Light | powerLED

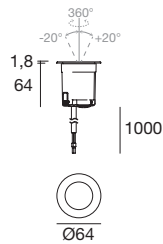

C.C. 4W DC - 350mA		Cct	Im S - D	Optic
Steel/Alu	80455	M 2700	490 - 360	20 Spot (20°)
Brass/Alu	82533	W 3000	490 - 360	30 Flood (30°)
		N 4000	529 - 389	60 W.Flood (60°)

Électronique

89421	99183	83100
ON/OFF 1 art. p 65 x l 74 x h 27	ON/OFF 1 - 2 art. p 80 x l 100 x h 31	DALI 1 - 4 art. p 54 x l 121 x h 26

C.V. 5W DC - 24 V DC		Cct	Im S - D	Optic
Steel/Alu	80456	M 2700	490 - 360	20 Spot (20°)
Brass/Alu	82534	W 3000	490 - 360	30 Flood (30°)
		N 4000	529 - 389	60 W.Flood (60°)

Électronique

89488	89179	89359	99332	99722
ON/OFF 1 - 2 art. p 80 x l 100 x h 31	ON/OFF 1 - 4 art. p 92 x l 117 x h 38	ON/OFF 1 - 9 art. p 115 x l 140 x h 50	0/1-10V 1 - 29 art. p 150 x l 60 x h 35	DALI 1 - 23 art. p 191 x l 63 x h 38

Boîtier d'encastrement Pag. 583

RTG 80455W20 / 80455W30

Suelo_RJ | Up-Light | 198-264 V AC | powerLED 4 W DC - 5 W AC

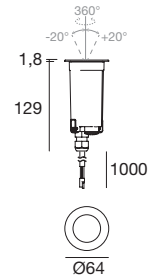

		Cct	Im S - D	Optic
Steel/Alu	80457	M 2700	490 - 360	20 Spot (20°)
		W 3000	490 - 360	30 Flood (30°)
		N 4000	529 - 389	60 W.Flood (60°)

Boîtier d'encastrement Pag. 583

Suelo_R | Up-Light | powerLED

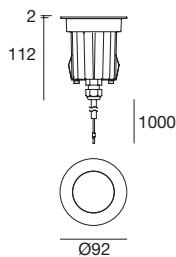

C.C. 8W DC - 630mA **Cct** **Im S - D** **Optic**

Steel/Alu	80546	M 2700	877 - 568	06 S.Spot (9°)
		W 3000	945 - 568	15 Spot (17°)
		N 4000	1013 - 613	30 Flood (26°)
				60 W.Flood (51°)
				88 Elliptic -
				12 E.W.Flood(104°)
				00 General (116°)
				07 Asymm. -

C.C. 8W DC - 630mA **HC** **Cct** **Im S - D** **Optic**

Steel/Alu	80547	M 2700	877 - 453	06 N.Spot (9°)
		W 3000	945 - 453	15 Spot (14°)
		N 4000	1013 - 489	30 Flood (24°)
				60 Flood (42°)

Électronique

99179	99186
ON/OFF	ON/OFF
1 art.	2 - 3 art.
p 80 x l 100 x h 31	p 92 x l 117 x h 38

C.V. 9W DC - 24 V DC **Cct** **Im S - D** **Optic**

Steel/Alu	80550	M 2700	877 - 568	06 S.Spot (9°)
		W 3000	945 - 568	15 Spot (17°)
		N 4000	1013 - 613	30 Flood (26°)
				60 W.Flood (51°)
				88 Elliptic -
				12 E.W.Flood(104°)
				00 General (116°)
				07 Asymm. -

C.V. 9W DC - 24 V DC **HC** **Cct** **Im S - D** **Optic**

Steel/Alu	80551	M 2700	877 - 453	06 N.Spot (9°)
		W 3000	945 - 453	15 Spot (14°)
		N 4000	1013 - 489	30 Flood (24°)
				60 Flood (42°)

Électronique

89179	89359	99331	99332	99722
ON/OFF	ON/OFF	ON/OFF	0/1-10V	DALI
1 - 2 art.	1 - 5 art.	1 - 15 art.	1 - 15 art.	1 - 12 art.
p 92 x l 117 x h 38	p 115 x l 140 x h 50	p 150 x l 60 x h 35	p 150 x l 60 x h 35	p 191 x l 63 x h 38

RGBW - 8W DC - 630 mA **Cct** **Optic**

Steel/Alu	81717	Q RGBW natural white	06 N.Spot -
		V RGBW warm white	15 Spot -
			45 Flood -

Électronique

99743 + 99702	99333	DMX	Driver	Switching
Dimmer RF	Dimmer DMX	DMX Controllers	Driver	Switching
1 - 12 art.	2 - 12 art.	CV 24V/48V	CV 48V	CV 48V
		Pag. 952 - 953	Pag. 941	Pag. 932

Boîtier d'encastrement Pag. 583

Suelo_R | Up-Light | 198-264 V AC | powerLED 8 W DC - 9 W AC

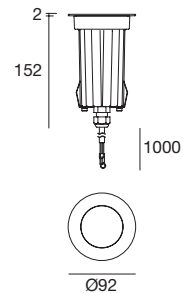
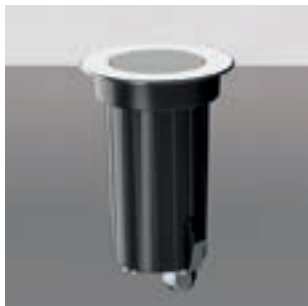

Cct **Im S - D** **Optic**

Steel/Alu	80554	M 2700	877 - 568	06 N.Spot (9°)
		W 3000	945 - 568	15 Spot (17°)
		N 4000	1013 - 613	30 Flood (26°)
				60 W.Flood (51°)
				88 Elliptic -
				12 E.W.Flood(104°)
				00 General (116°)
				07 Asymm. -

Cct **Im S - D** **Optic**

Steel/Alu	80555	M 2700	877 - 453	06 N.Spot (9°)
		W 3000	945 - 453	15 Spot (14°)
		N 4000	1013 - 489	30 Flood (24°)
				60 W.Flood (42°)

Boîtier d'encastrement Pag. 583



Suelo_R Pro | Up-Light | powerLED

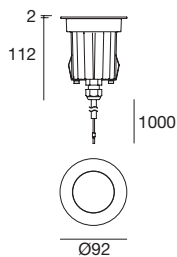

C.C. 8W DC - 630mA	Cct	Im S - D	Optic
Steel Alu 80558	M 2700	877 - 510	06 N.Spot (6°)
C.C. 8W DC - 630mA HC	W 3000	945 - 510	15 Spot (15°)
Steel Alu 80559	N 4000	1013 - 547	30 Flood (25°)
C.C. 8W DC - 630mA DL			60 W.Flood (57°)
Steel Alu 80560			

Électronique

99179	99186
ON/OFF 1 art. p 80 x l 100 x h 31	ON/OFF 2 - 3 art. p 92 x l 117 x h 38

C.V. 9W DC - 24 V DC	Cct	Im S - D	Optic
Steel Alu 80564	M 2700	877 - 510	06 N.Spot (9°)
C.V. 9W DC - 24 V DC HC	W 3000	945 - 510	15 Spot (14°)
Steel Alu 80565	N 4000	1013 - 547	30 Flood (24°)
C.V. 9W DC - 24 V DC DL			60 Flood (42°)
Steel Alu 80566			

Électronique

89179	89359	99331	99332	99722
ON/OFF 1 - 2 art. p 92 x l 117 x h 38	ON/OFF 1 - 5 art. p 115 x l 140 x h 50	ON/OFF 1 - 15 art. p 150 x l 60 x h 35	0/1-10V 1 - 15 art. p 150 x l 60 x h 35	DALI 1 - 12 art. p 191 x l 63 x h 38

Boîtier d'encastrement Pag. 583

RTG 80566W06 / 80566W30

Suelo_R Pro | Up-Light | 198-264 V AC | powerLED 8 W DC - 9 W AC

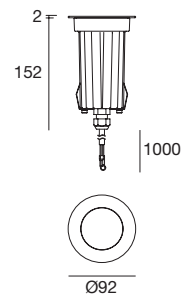

	Cct	Im S - D	Optic
Steel Alu 80570	M 2700	877 - 510	06 N.Spot (6°)
Brass Alu 82535	W 3000	945 - 510	15 Spot (15°)
HC	N 4000	1013 - 547	30 Flood (25°)
Steel Alu 80571			60 W.Flood (57°)
Brass Alu 82536			
DL			
Steel Alu 80572			
Brass Alu 82537			

Boîtier d'encastrement Pag. 583



Suelo_R Pro Brass

Suelo_R Pro Steel

Suelo_RJ Pro | Up-Light | powerLED

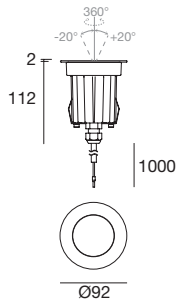
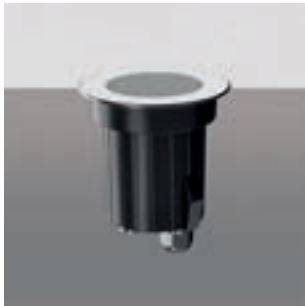

C.C. 8W DC - 630mA	Cct	lm S - D	Optic
Steel Alu 80576	M 2700	760 - 558	20 Spot (20°)
	W 3000	760 - 558	30 Flood (30°)
	N 4000	821 - 603	60 W.Flood (60°)

Électronique

99179	99186
ON/OFF 1 art. p 80 x l 100 x h 31	ON/OFF 2 - 3 art. p 92 x l 117 x h 38

C.V. 9W DC - 24 V DC	Cct	lm S - D	Optic
Steel Alu 80578	M 2700	760 - 558	20 Spot (20°)
	W 3000	760 - 558	30 Flood (30°)
	N 4000	821 - 603	60 W.Flood (60°)

Électronique

89179	89359	99331	99332	99722
ON/OFF 1 - 2 art. p 92 x l 117 x h 38	ON/OFF 1 - 5 art. p 115 x l 140 x h 50	ON/OFF 1 - 15 art. p 150 x l 60 x h 35	0/1-10V 1 - 15 art. p 150 x l 60 x h 35	DALI 1 - 12 art. p 191 x l 63 x h 38

Boîtier d'encastrement Pag. 583

Suelo_RJ Pro | Up-Light | 198-264 V AC | powerLED 8 W DC - 9 W AC

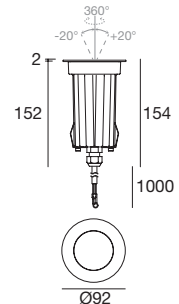

	Cct	lm S - D	Optic
Steel Alu 80580	M 2700	760 - 558	20 Spot (20°)
	W 3000	760 - 558	30 Flood (30°)
	N 4000	821 - 603	60 W.Flood (60°)

Boîtier d'encastrement Pag. 583

Suelo_RX Pro | Up-Light | powerLED

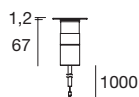

C.C. 2W DC - 630mA		Cct	lm S - D	Optic
Steel/Alu	80435	M 2700	219 - 120	15 Spot (22°)
Brass/Alu	82538	W 3000	233 - 137	30 Flood (27°)
		N 4000	249 - 147	60 W.Flood (52°)
				00 General (115°)

C.C. 2W DC - 630mA HC		Cct	lm S - D	Optic
Steel/Alu	80436	M 2700	219 - 76	15 Spot (19°)
Brass/Alu	82539	W 3000	233 - 85	30 Flood (25°)
		N 4000	249 - 91	60 W.Flood (44°)

Électronique

89420	99179	99186	83102
ON/OFF 1 - 2 art. p 65 x l 74 x h 27	ON/OFF 3 - 6 art. p 80 x l 100 x h 31	ON/OFF 6 - 12 art. p 92 x l 117 x h 38	DALI 1 - 14 art. p 54 x l 121 x h 26

C.V. 2,5W DC - 24 V DC		Cct	lm S - D	Optic
Steel/Alu	80437	M 2700	219 - 120	15 Spot (22°)
Brass/Alu	82540	W 3000	233 - 137	30 Flood (27°)
		N 4000	249 - 147	60 W.Flood (52°)
				00 General (115°)

C.V. 2,5W DC - 24 V DC HC		Cct	lm S - D	Optic
Steel/Alu	80438	M 2700	219 - 76	15 Spot (19°)
Brass/Alu	82541	W 3000	233 - 85	30 Flood (25°)
		N 4000	249 - 91	60 W.Flood (44°)

Électronique

89488	89179	89359	99332	99722
ON/OFF 1 - 7 art. p 80 x l 100 x h 31	ON/OFF 1 - 12 art. p 92 x l 117 x h 38	ON/OFF 1 - 24 art. p 115 x l 140 x h 50	0/1-10V 1 - 75 art. p 150 x l 60 x h 35	DALI 1 - 60 art. p 191 x l 63 x h 38

Boîtier d'encastrement Pag. 583

Suelo_RX | Up-Light | powerLED

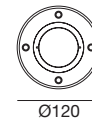
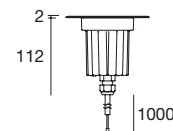

C.C. - 8W DC - 630 mA		Cct	lm S - D	Optic
Steel/Alu	80548	M 2700	877 - 568	06 N.Spot (9°)
		W 3000	945 - 568	15 Spot (17°)
		N 4000	1013 - 613	30 Flood (26°)
				60 W.Flood (51°)
				88 Elliptic -
				12 E.W.Flood(104°)
				00 General (116°)
				07 Asymm. -

C.C. - 8W DC - 630 mA HC		Cct	lm S - D	Optic
Steel/Alu	80549	M 2700	877 - 453	06 N.Spot (9°)
		W 3000	945 - 453	15 Spot (14°)
		N 4000	1013 - 489	30 Flood (24°)
				60 W.Flood (42°)

Électronique

99179	99186
ON/OFF 1 art. p 80 x l 100 x h 31	ON/OFF 2 - 3 art. p 92 x l 117 x h 38

C.V. - 9W DC - 24 V DC		Cct	lm S - D	Optic
Steel/Alu	80552	M 2700	877 - 568	06 N.Spot (9°)
		W 3000	945 - 568	15 Spot (17°)
		N 4000	1013 - 613	30 Flood (26°)
				60 W.Flood (51°)
				88 Elliptic -
				12 E.W.Flood(104°)
				00 General (116°)
				07 Asymm. -

C.V. - 9W DC - 24 V DC HC		Cct	lm S - D	Optic
Steel/Alu	80553	M 2700	877 - 453	06 N.Spot (9°)
		W 3000	945 - 453	15 Spot (14°)
		N 4000	1013 - 489	30 Flood (24°)
				60 W.Flood (42°)

Électronique

89179	89359	99331	99332	99722
ON/OFF 1 - 2 art. p 92 x l 117 x h 38	ON/OFF 1 - 5 art. p 115 x l 140 x h 50	ON/OFF 1 - 15 art. p 150 x l 60 x h 35	0/1-10V 1 - 15 art. p 150 x l 60 x h 35	DALI 1 - 12 art. p 191 x l 63 x h 38

RGBW - 8W - 630mA		Cct	Optic
Steel/Alu	81718	Q RGBW natural white	06 N.Spot -
		V RGBW warm white	15 Spot -
			45 Flood -

Électronique

99743 + 99702	99333	DMX	Driver	Switching
Dimmer RF 1 - 12 art.	Dimmer DMX 2 - 12 art.	DMX Controllers CV 24V/48V Pag. 952 - 953	Driver CV 48V Pag. 941	Switching CV 48V Pag. 932

Boîtier d'encastrement Pag. 583

Suelo_RX Pro | Up-Light | 198-264 V AC | powerLED 8 W DC - 9 W AC

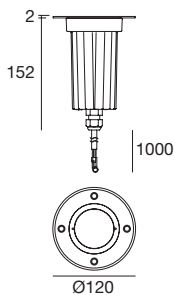

	Cct	lm S - D	Optic
Steel/Alu 80573	M 2700	877 - 510	06 N.Spot (6°)
Brass/Alu 82542	W 3000	945 - 510	15 Spot (15°)
	N 4000	1013 - 547	30 Flood (25°)
			60 W.Flood (57°)
Steel/Alu 80574			
Brass/Alu 82543			
Steel/Alu 80575			
Brass/Alu 82544			

Boîtier d'encastrement Pag. 583

Suelo_RXJ | Up-Light | powerLED

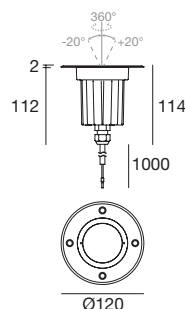
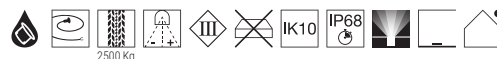

C.C. - 8W DC - 630 mA	Cct	lm S - D	Optic
Steel/Alu 80577	M 2700	760 - 558	20 Spot (20°)
	W 3000	760 - 558	30 Flood (30°)
	N 4000	821 - 603	60 W.Flood (60°)

Électronique

99179	99186
ON/OFF 1 art. p 80 x l 100 x h 31	ON/OFF 2 - 3 art. p 92 x l 117 x h 38

C.V. 9W DC - 24 V DC	Cct	lm S - D	Optic
Steel/Alu 80579	M 2700	760 - 558	20 Spot (20°)
	W 3000	760 - 558	30 Flood (30°)
	N 4000	821 - 603	60 W.Flood (60°)

Électronique

89179	89359	99331	99332	99722
ON/OFF 1 - 2 art. p 92 x l 117 x h 38	ON/OFF 1 - 5 art. p 115 x l 140 x h 50	ON/OFF 1 - 15 art. p 150 x l 60 x h 35	0/1-10V 1 - 15 art. p 150 x l 60 x h 35	DALI 1 - 12 art. p 191 x l 63 x h 38

Boîtier d'encastrement Pag. 583

Suelo_RXJ | Up-Light | 198-264 V AC | powerLED 8 W DC - 9 W AC

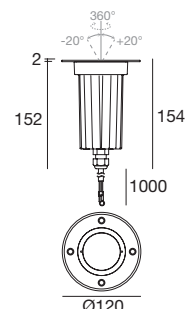

	Cct	lm S - D	Optic
Steel/Alu 80581	M 2700	760 - 558	20 Spot (20°)
Brass/Alu 82545	W 3000	760 - 558	30 Flood (30°)
	N 4000	821 - 603	60 W.Flood (60°)

Boîtier d'encastrement Pag. 583

RTG 80581W30 / 80581W60



Suelo_RX | Up-Light | 198-264 V AC | arrayLED 13W DC - 15W AC

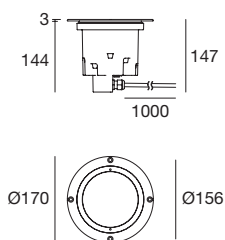

	Cct	Im S - D	Optic
Steel Alu 80607	M 2700	1724 - 1098	15 Spot (14°)
	W 3000	1724 - 1144	35 Flood (33°)
	N 4000	1854 - 1208	60 W.Flood (64°)

	Cct	Im S - D	Optic
Steel Alu 81109	M 2700	1683 - 769	07 Asymm. -
	W 3000	1808 - 800	
	N 4000	1949 - 864	

	Cct	Im S - D	Optic
Steel Alu 80608	M 2700	1470 - 1007	06 N.Spot (7°)
	W 3000	1470 - 1050	
	N 4000	1587 - 1109	

	Cct	Im S - D	Optic
Steel Alu 81740 HC	M 2700	1724 - 668	15 Spot (14°)
	W 3000	1724 - 696	35 Flood (29°)
Steel Alu 81741 DL	N 4000	1854 - 735	60 W.Flood (49°)

	Cct	Optic
RGBW - 13 WDC - 350 mA		
Steel Alu 81719	Q RGBW natural white	15 Spot -
	V RGBW warm white	30 Flood -
		60 W.Flood -

Électronique

99741 + 99702	99333	DMX	Driver	Switching
Dimmer RF 1 - 3 art.	Dimmer DMX 2 - 3 art.	DMX Controllers Pag. 952 - 953	Driver CV 48V Pag. 941	Switching CV 48V Pag. 932

Boîtier d'encastrement Pag. 583

RTG 80607W30

Suelo_RX Pro | Up-Light | 198-264 V AC | arrayLED 13 W DC - 15 W AC

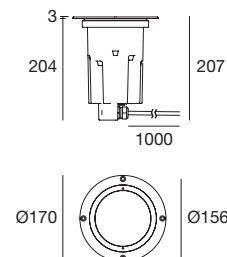

	Cct	Im S - D	Optic
Steel Alu 80611	M 2700	1724 - 1098	15 Spot (14°)
Brass Alu 82546	W 3000	1724 - 1144	35 Flood (33°)
	N 4000	1854 - 1208	60 W.Flood (64°)

	Cct	Im S - D	Optic
Steel Alu 80612	M 2700	1683 - 1184	07 Asymm. -
Brass Alu 82547	W 3000	1808 - 1265	
	N 4000	1949 - 1265	

	Cct	Im S - D	Optic
Steel Alu 81744 HC	M 2700	1724 - 668	15 Spot (14°)
Brass Alu 82548	W 3000	1724 - 696	35 Flood (29°)
	N 4000	1854 - 735	60 W.Flood (49°)
Steel Alu 81745			
Brass Alu 82549			

Boîtier d'encastrement Pag. 583

Suelo_RX | Up-Light | 198-264 V AC | arrayLED 13 W DC - 15 W AC

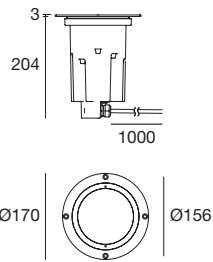
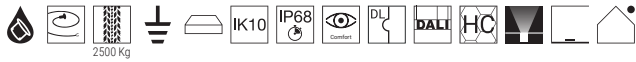

DALI	Cct	lm S - D	Optic
Steel/Alu 80609	M 2700	1470 - 1007	06 N.Spot (7°)
	W 3000	1470 - 1050	
	N 4000	1587 - 1109	

DALI	Cct	lm S - D	Optic
Steel/Alu 80610	M 2700	1724 - 1098	15 Spot (14°)
	W 3000	1724 - 1144	35 Flood (33°)
	N 4000	1854 - 1208	60 W.Flood (64°)

DALI	Cct	lm S - D	Optic
Steel/Alu 81110	M 2700	1470 - 769	07 Asymm. -
	W 3000	1470 - 800	
	N 4000	1587 - 846	

DALI	HC	Cct	lm S - D	Optic
Steel/Alu 81742		M 2700	1724 - 668	15 Spot (14°)
	DL	W 3000	1724 - 735	35 Flood (29°)
Steel/Alu 81743		N 4000	1854 - 735	60 W.Flood (49°)

Boîtier d'encastrement Pag. 583

Suelo_RXJ | Up-Light | 198-264 V AC | arrayLED 13 W DC - 15 W AC

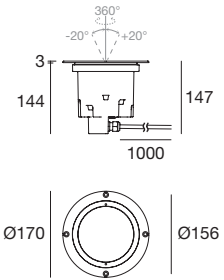

	Cct	lm S - D	Optic
Steel/Alu 80613	M 2700	1724 - 978	15 Spot (16°)
Brass/Alu 82550	W 3000	1724 - 1020	35 Flood (30°)
	N 4000	1854 - 1077	45 W.Flood (46°)

Boîtier d'encastrement Pag. 583

Suelo_RXJ | Up-Light | 198-264 V AC | arrayLED 13 W DC - 15 W AC

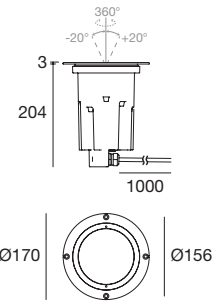
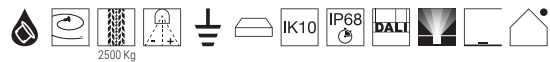

DALI	Cct	lm S - D	Optic
Steel/Alu 81111	M 2700	1724 - 978	15 Spot (16°)
	W 3000	1724 - 1020	35 Flood (30°)
	N 4000	1854 - 1077	45 W.Flood (46°)

Boîtier d'encastrement Pag. 583

Suelo_RX | Up-Light | 198-264 V AC | arrayLED

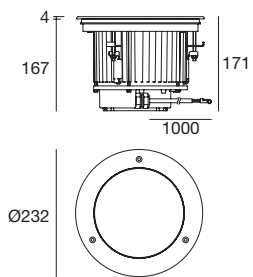
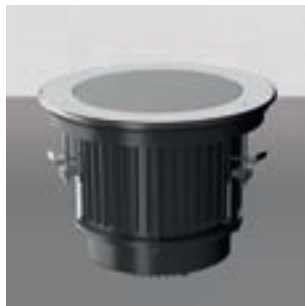
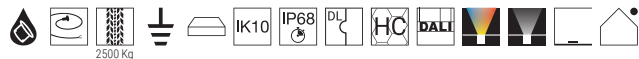

30 W DC - 33,6 W AC	Cct	Im S - D	Optic
Steel/Alu 80614	M 2700	4088 - 3159	15 Spot (18°)
	W 3000	4372 - 3293	35 Flood (31°)
	N 4000	4702 - 3475	60 W.Flood (57°)

30 W DC - 33,6 W AC	Cct	Im S - D	Optic
Steel/Alu 80615	M 2700	3428 - 2032	06 N.Spot (7°)
	W 3000	3428 - 2117	
	N 4000	3700 - 2234	

25 W DC - 27 W AC	Cct	Im S - D	Optic
Steel/Alu 80616	M 2700	3167 - On Req	07 Asymm. -
	W 3000	3401 - On Req	
	N 4000	3667 - On Req	

25 W DC - 27 W AC	HC	Cct	Im S - D	Optic
Steel/Alu 81746		M 2700	4088 - 1743	15 Spot (18°)
25 W DC - 27 W AC	DL	W 3000	4372 - 1816	35 Flood (28°)
Steel/Alu 81747		N 4000	4702 - 1918	60 W.Flood (40°)

30 W DC - 33,6 W AC	DALI	Cct	Im S - D	Optic
Steel/Alu 81732		M 2700	4088 - 3159	15 Spot (18°)
		W 3000	4372 - 3293	30 Flood (31°)
		N 4000	4702 - 3475	60 W.Flood (57°)

30 W DC - 33,6 W AC	Cct	Im S - D	Optic
Steel/Alu 81733	M 2700	3428 - 2032	06 N.Spot (7°)
	W 3000	3428 - 2117	
	N 4000	3700 - 2234	

25 W DC - 27 W AC	Cct	Im S - D	Optic
Steel/Alu 81734	M 2700	3167 - On Req	07 Asymm. -
	W 3000	3401 - On Req	
	N 4000	3667 - On Req	

25 W DC - 27 W AC	HC	Cct	Im S - D	Optic
Steel/Alu 81748		M 2700	4088 - 1743	15 Spot (18°)
25 W DC - 27 W AC	DL	W 3000	4372 - 1816	35 Flood (28°)
Steel/Alu 81749		N 4000	4702 - 1918	60 W.Flood (40°)

RGBW - 23 WDC - 220 mA	Cct	Optic
Steel/Alu 81737	Q RGBW natural white	15 Spot -
	V RGBW warm white	30 Flood -
		60 W.Flood -

Électronique

99703 + 99702	99333	DMX	Driver	Switching
Dimmer RF 1 art.	Dimmer DMX 1 art.	DMX Controllers Pag. 952 - 953	Driver CV 48V Pag. 941	Switching CV 48V Pag. 932

Boîtier d'encastrement Pag. 583

Suelo_RXJ | Up-Light | 198-264 V AC | arrayLED 30 W DC - 33,6 W AC

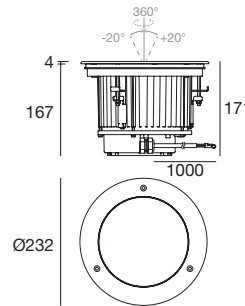

	Cct	Im S - D	Optic
Steel/Alu 80617	M 2700	4088 - 2945	15 Spot (18°)
	W 3000	4372 - 3068	30 Flood (34°)
	N 4000	4702 - 3240	60 W.Flood (58°)

DALI	Cct	Im S - D	Optic
Steel/Alu 81735	M 2700	4088 - 2945	15 Spot (18°)
	W 3000	4372 - 3068	30 Flood (34°)
	N 4000	4702 - 3240	60 W.Flood (58°)

Boîtier d'encastrement Pag. 583

Suelo_RDX | Up-Light | 198-264 V AC | powerLED 12 W DC - 13,5 W AC

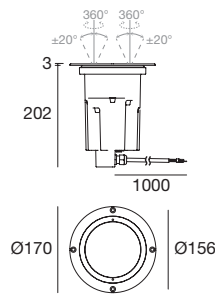

	Cct	lm S - D	Optic
Steel/Alu 81619	M 2700	1114 - On Req	15 Spot (19°)
	W 3000	1176 - On Req	30 Flood (26°)
	N 4000	1300 - On Req	60 W.Flood (64°)

Boîtier d'encastrement Pag. 583

Suelo_RDX | Up-Light | 198-264 V AC | powerLED 24 W DC - 26 W AC

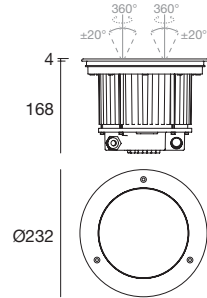

	Cct	lm S - D	Optic
Steel/Alu 81620	M 2700	3122 - On Req	15 Spot -
	W 3000	3254 - On Req	30 Flood -
	N 4000	3463 - On Req	60 W.Flood -

Boîtier d'encastrement Pag. 583

Compartment
optique en retrait

Basculement indépendant

Optiques personnalisables
individuellement sur demande



Suelo_RX | Up-Light | 198-264 V AC | arrayLED

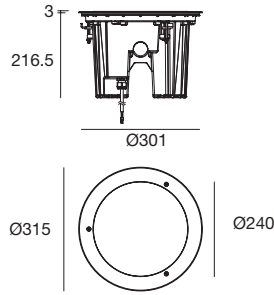

44,2 W DC - 48,2 W AC	Cct	Im S - D	Optic
Steel/Alu 83925	M 2700	6489 -	15 Spot (18°)
DALI 44,2 W DC - 48,2 W AC	W 3000	6762 -	30 Flood (31°)
Steel/Alu 83928	N 4000	7139 -	50 W.Flood (57°)

44,2 W DC - 48,2 W AC ^{HC}	Cct	Im S - D	Optic
Steel/Alu 83926	M 2700	6489 -	15 Spot (18°)
DALI 44,2 W DC - 48,2 W AC	W 3000	6762 -	30 Flood (31°)
Steel/Alu 83929	N 4000	7139 -	50 W.Flood (57°)

44,2 W DC - 48,2 W AC ^{DL}	Cct	Im S - D	Optic
Steel/Alu 83927	M 2700	6489 -	15 Spot (18°)
DALI 44,2 W DC - 48,2 W AC	W 3000	6762 -	30 Flood (31°)
Steel/Alu 83930	N 4000	7139 -	50 W.Flood (57°)

44,2 W DC - 48,2 W AC	Cct	Im S - D	Optic
Steel/Alu 83937	M 2700	4849 -	06 Spot -
DALI 44,2 W DC - 48,2 W AC	W 3000	4849 -	
Steel/Alu 83938	N 4000	5235 -	

RGBW 37W DC - 41W AC	Cct	Optic
Steel/Alu 83941	V RGBW warm white	15 Spot (18°) 30 Flood (31°) 50 W.Flood (57°)

Électronique

99741 + 99702	99333	DMX	Driver	Switching
Dimmer RF 1 art.	Dimmer DMX 2 - 3 art.	DMX Controllers Pag. 952 - 953	Driver CV 48V Pag. 941	Switching CV 48V Pag. 932

Boîtier d'encastrement Pag. 583

Suelo_RXJ | Up-Light | 198-264 V AC | arrayLED

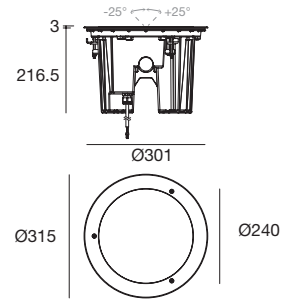

44,2 W DC - 48,2 W AC	Cct	Im S - D	Optic
Steel/Alu 82713	M 2700	6489 -	15 Spot (18°)
DALI 44,2 W DC - 48,2 W AC	W 3000	6762 -	30 Flood (31°)
Steel/Alu 82716	N 4000	7139 -	50 W.Flood (57°)

44,2 W DC - 48,2 W AC ^{HC}	Cct	Im S - D	Optic
Steel/Alu 82714	M 2700	6489 -	15 Spot (18°)
DALI 44,2 W DC - 48,2 W AC	W 3000	6762 -	30 Flood (31°)
Steel/Alu 82717	N 4000	7139 -	50 W.Flood (57°)

44,2 W DC - 48,2 W AC ^{DL}	Cct	Im S - D	Optic
Steel/Alu 82715	M 2700	6489 -	15 Spot (18°)
DALI 44,2 W DC - 48,2 W AC	W 3000	6762 -	30 Flood (31°)
Steel/Alu 82718	N 4000	7139 -	50 W.Flood (57°)

44,2 W DC - 48,2 W AC	Cct	Im S - D	Optic
Steel/Alu 82719	M 2700	4849 -	06 Spot -
DALI 44,2 W DC - 48,2 W AC	W 3000	4849 -	
Steel/Alu 82720	N 4000	5235 -	

RGBW 37W DC - 41W AC	Cct	Optic
Steel/Alu 82723	V RGBW warm white	15 Spot (18°) 30 Flood (31°) 50 W.Flood (57°)

Électronique

99741 + 99702	99333	DMX	Driver	Switching
Dimmer RF 1 art.	Dimmer DMX 2 - 3 art.	DMX Controllers Pag. 952 - 953	Driver CV 48V Pag. 941	Switching CV 48V Pag. 932

Boîtier d'encastrement Pag. 583

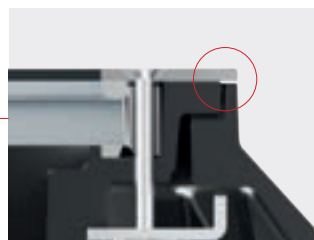
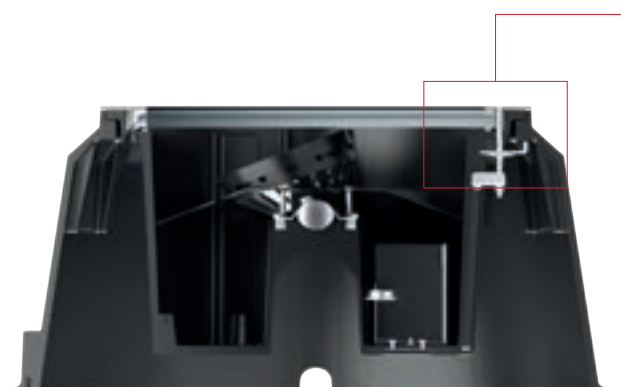

Suitable for RX / RXJ Ø 315

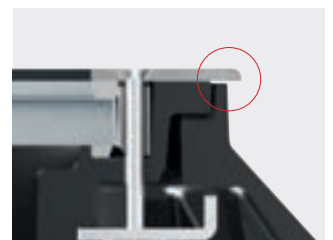

Suitable for RF / RFJ Ø 308

Suelo_RF | Up-Light | 198-264 V AC | arrayLED

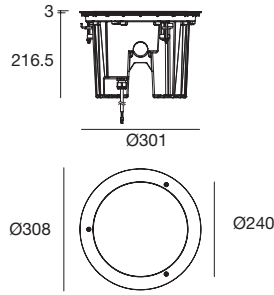

44,2 W DC - 48,2 W AC	Cct	Im S - D	Optic
Steel/Alu 83931	M 2700	6489 -	15 Spot (18°)
DALI 44,2 W DC - 48,2 W AC	W 3000	6762 -	30 Flood (31°)
Steel/Alu 83934	N 4000	7139 -	50 W.Flood (57°)

44,2 W DC - 48,2 W AC ^{HC}	Cct	Im S - D	Optic
Steel/Alu 83932	M 2700	6489 -	15 Spot (18°)
DALI 44,2 W DC - 48,2 W AC	W 3000	6762 -	30 Flood (31°)
Steel/Alu 83935	N 4000	7139 -	50 W.Flood (57°)

44,2 W DC - 48,2 W AC ^{DL}	Cct	Im S - D	Optic
Steel/Alu 83933	M 2700	6489 -	15 Spot (18°)
DALI 44,2 W DC - 48,2 W AC	W 3000	6762 -	30 Flood (31°)
Steel/Alu 83936	N 4000	7139 -	50 W.Flood (57°)

44,2 W DC - 48,2 W AC	Cct	Im S - D	Optic
Steel/Alu 83939	M 2700	4849 -	06 Spot -
DALI 44,2 W DC - 48,2 W AC	W 3000	4849 -	
Steel/Alu 83940	N 4000	5235 -	

RGBW 37W DC - 41W AC	Cct	Optic
Steel/Alu 83942	V RGBW warm white	15 Spot (18°)
		30 Flood (31°)
		50 W.Flood (57°)

Électronique

99741 + 99702	99333	DMX	Driver	Switching
Dimmer RF 1 art.	Dimmer DMX 2 - 3 art.	DMX Controllers Pag. 952 - 953	Driver CV 48V Pag. 941	Switching CV 48V Pag. 932

Boîtier d'encastrement Pag. 583

Suelo_RFJ | Up-Light | 198-264 V AC | arrayLED

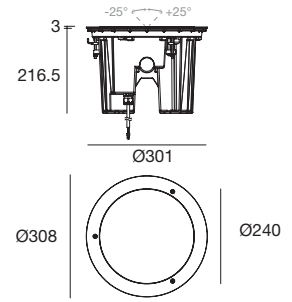

44,2 W DC - 48,2 W AC	Cct	Im S - D	Optic
Steel/Alu 83776	M 2700	6489 -	15 Spot (18°)
DALI 44,2 W DC - 48,2 W AC	W 3000	6762 -	30 Flood (31°)
Steel/Alu 83779	N 4000	7139 -	50 W.Flood (57°)

44,2 W DC - 48,2 W AC ^{HC}	Cct	Im S - D	Optic
Steel/Alu 83777	M 2700	6489 -	15 Spot (18°)
DALI 44,2 W DC - 48,2 W AC	W 3000	6762 -	30 Flood (31°)
Steel/Alu 83780	N 4000	7139 -	50 W.Flood (57°)

44,2 W DC - 48,2 W AC ^{DL}	Cct	Im S - D	Optic
Steel/Alu 83778	M 2700	6489 -	15 Spot (18°)
DALI 44,2 W DC - 48,2 W AC	W 3000	6762 -	30 Flood (31°)
Steel/Alu 83781	N 4000	7139 -	50 W.Flood (57°)

44,2 W DC - 48,2 W AC	Cct	Im S - D	Optic
Steel/Alu 82721	M 2700	4849 -	06 Spot -
DALI 44,2 W DC - 48,2 W AC	W 3000	4849 -	
Steel/Alu 82722	N 4000	5235 -	

RGBW 37W DC - 41W AC	Cct	Optic
Steel/Alu 82724	V RGBW warm white	15 Spot (18°)
		30 Flood (31°)
		50 W.Flood (57°)

Électronique

99741 + 99702	99333	DMX	Driver	Switching
Dimmer RF 1 art.	Dimmer DMX 2 - 3 art.	DMX Controllers Pag. 952 - 953	Driver CV 48V Pag. 941	Switching CV 48V Pag. 932

Boîtier d'encastrement Pag. 583

Easy Adjust. System™



Grâce au système breveté par les bureaux techniques i-Lèd, le nouveau boîtier d'encastrement de Suelo permet de fixer le projecteur à encastrer sans ouvrir le corps avec un système d'entailles, qui empêchent la rotation du produit, ce qui rend l'installation du boîtier d'encastrement facile et sûre.



Suelo Telescopic | Up-Light | 198-264 V AC | arrayLED 12 W DC - 13,5 W AC

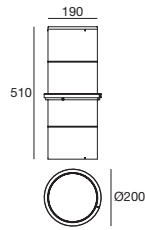

	Cct	lm S - D	Optic
DarkBrown 81475	M 2700	1743 - 900	15 Spot (20°)
	W 3000	1863 - 962	30 Flood (40°)
	N 4000	1863 - 962	60 W.Flood (51°)

Boîtier d'encastrement Pag. 583

Suelo Telescopic | Up-Light | 198-250 V | arrayLED 26 W DC - 29 W AC

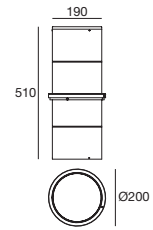
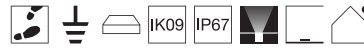

	Cct	lm S - D	Optic
DarkBrown 81476	M 2700	3400 - 1720	15 Spot (27°)
	W 3000	3673 - 1847	30 Flood (39°)
	N 4000	3909 - 1847	60 W.Flood (51°)

Boîtier d'encastrement Pag. 583



Suelo_I Focus | Up-Light | 198-264 V AC | arrayLED 8 W DC - 9,5 W AC

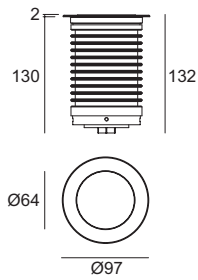

	Cct	lm S - D	Optic
Steel/Alu 81692	M 2700	831 - On Req	85 Adj. (10°-65°)
	W 3000	770 - On Req	
	N 4000	770 - On Req	

Boîtier d'encastrement Pag. 583

Suelo Focus | Up-Light | 198-264 V AC | arrayLED 8 W DC - 9,5 W AC

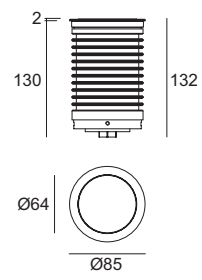

	Cct	lm S - D	Optic
Steel/Alu 81693	M 2700	831 - On Req	85 Adj. (10°-65°)
	W 3000	770 - On Req	
	N 4000	770 - On Req	

Boîtier d'encastrement Pag. 583



Narrow Spot



Spot



Spot



Flood



Medium Flood

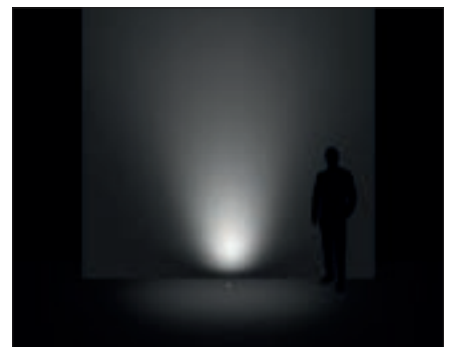

Medium Flood



Suelo_Brass | Up-Light | 190-250 V | powerLED 8 W DC - 9 W AC

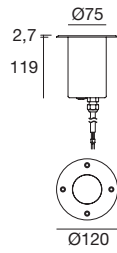
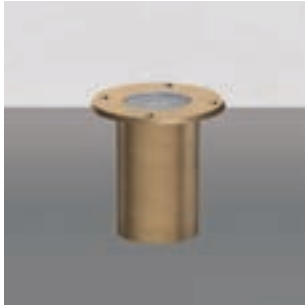

	Cct	Im S - D	Optic
Brass 82266	M 2700	902 - On Req	06 N.Spot -
	W 3000	945 - On Req	-
	N 4000	1016 - On Req	-

	Cct	Im S - D	Optic
Brass 82267	M 2700	902 - On Req	15 Spot -
	W 3000	945 - On Req	35 Flood -
	N 4000	1016 - On Req	60 W.Flood -

	Cct	Im S - D	Optic
Brass 82268 HC	M 2700	902 - On Req	06 N.Spot -
	W 3000	945 - On Req	-
	N 4000	1016 - On Req	-

	Cct	Im S - D	Optic
Brass 82269 HC	M 2700	902 - On Req	15 Spot -
	W 3000	945 - On Req	35 Flood -
	N 4000	1016 - On Req	60 W.Flood -

Boîtier d'encastrement Pag. 583

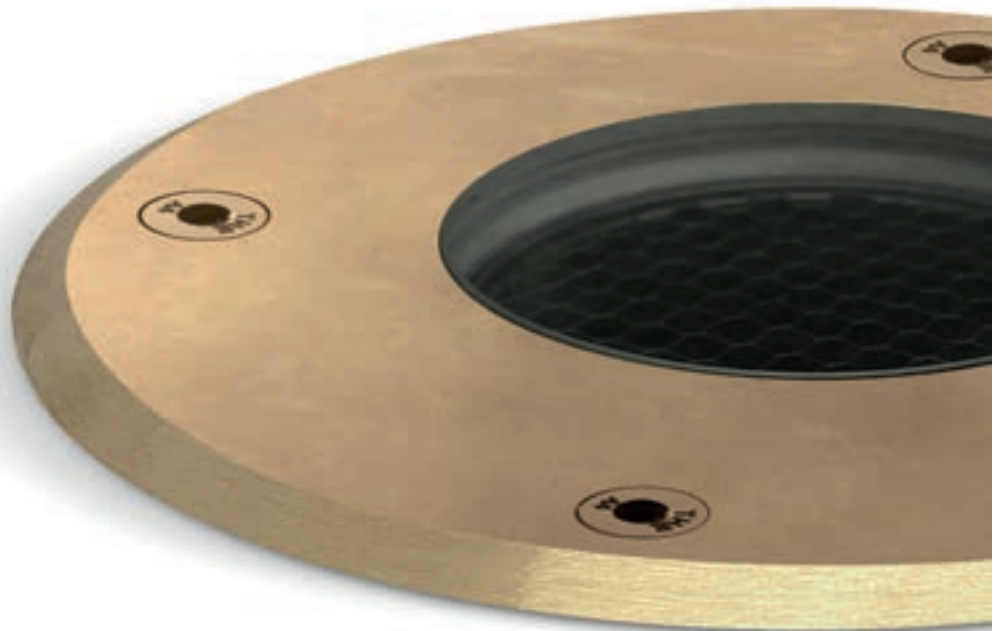

Boîtier d'encastrement

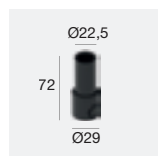

description	type
99676 Boîtiers d'encastrement	PVC
suitable for: Suelo_R 1W	



description	type
84918 Boîtiers d'encastrement	PVC
suitable for: Suelo_R 2W	

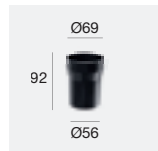

description	type
84936 Boîtiers d'encastrement	PVC
suitable for: Suelo_R 4W - 5W (H64) Suelo_RJ 4W - 5W (H64)	

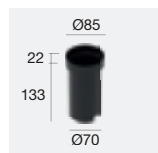

description	type
99680 Boîtiers d'encastrement	PVC
suitable for: Suelo_R 8W - 9W (H112) Suelo_R Pro 8W - 9W (H112) / Suelo_RJ Pro 8W - 9W (H112)	

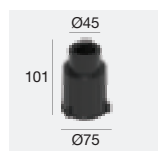

description	type
99685 Boîtiers d'encastrement	PVC
suitable for: Suelo_RX Pro 2W - 2,5W	

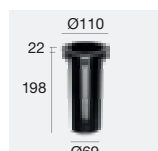

description	type
98122 Boîtiers d'encastrement	PVC
suitable for: Suelo_RX 8W (H152) Suelo_RXJ 8W (H154) / Suelo_RX Pro 8W (H152)	



description	type
84932 Boîtiers d'encastrement	PVC
suitable for: Suelo_RX Pro 13W / Suelo_RX 13W (H204) Suelo_RXJ 13W (H204) / Suelo_RDX 12W	

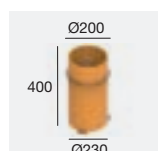

description	type
99747 Boîtiers d'encastrement	PVC
suitable for: Suelo Telescopic 12W Suelo Telescopic 24W	

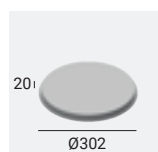

description	type
83097 Gabarit	PVC
suitable for: 83096	

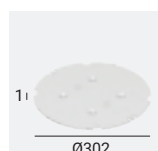

description	type
93099 Fond du boîtier	PVC
suitable for: 83096	



description	type
99804 Boîtiers d'encastrement	PVC
suitable for: Suelo Focus 8W	

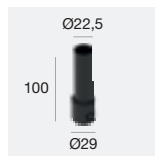

description	type
99677 Boîtiers d'encastrement	PVC
suitable for: Suelo_R Pro 1W - 1,5W	

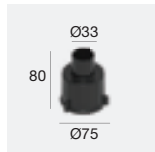

description	type
99684 Boîtiers d'encastrement	PVC
suitable for: Suelo_R Pro 2W - 2,5W	

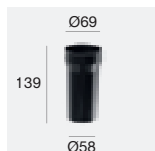

description	type
84935 Boîtiers d'encastrement	PVC
suitable for: Suelo_R 4W (H129) / Suelo_R 5W (H129) Suelo_R Pro 4W - 5W / Suelo_RJ 4W (H129)	

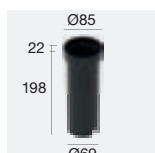

description	type
99681 Boîtiers d'encastrement	PVC
suitable for: Suelo_R 8W (H152) / Suelo_R Pro 8W (H152) Suelo_RJ Pro 8W (H152)	

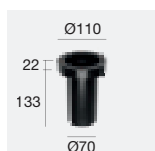

description	type
98121 Boîtiers d'encastrement	PVC
suitable for: Suelo_RX 8W - 9W (H112) Suelo_RX Pro 8W - 9W (H112) / Suelo_RXJ 8W - 9W (H112)	



description	type
84933 Boîtiers d'encastrement	PVC
suitable for: Suelo_RX 13W (H144) Suelo_RXJ 13W (H144)	



description	type
99794 Boîtiers d'encastrement	PVC
suitable for: Suelo_RX 23W - 25W - 30W Suelo_RXJ 30W / Suelo_RDX 24W	



description	type
83096 Boîtiers d'encastrement	PVC
suitable for: Suelo_RX 37W - 44,2W / Suelo_RXJ 37W - 44,2W / Suelo_RF 37W - 44,2W / Suelo_RFJ 37W - 44,2W	

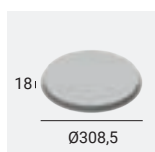

description	type
83098 Gabarit	PVC
suitable for: 83096	



description	type
84900 Boîtiers d'encastrement	PVC
suitable for: Suelo_Brass 8W	



description	type
99803 Boîtiers d'encastrement	PVC
suitable for: Suelo_I Focus 8W / Suelo Focus 8W	

orma

Matériaux

Corps en aluminium

Diffuseur en verre trempé extra-clair





orma range

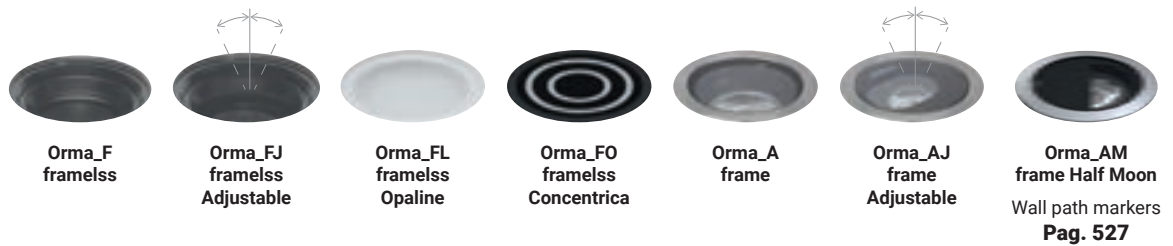

	Orma_F framelss	Orma_FJ framelss Adjustable	Orma_FL framelss Opaline	Orma_FO framelss Concentrica	Orma_A frame	Orma_AJ frame Adjustable	Orma_AM frame Half Moon Wall path markers Pag. 527
Ø22,5	1W CC 1,5W CV	-	1W CC 1,5W CV	-	-	-	-
Ø42	-	-	-	1,5W CV	-	-	-
Ø54 - Ø56	4W CC 5W CV	4W CC 5W CV	1W CC 1,5W CV	1W CC 1,5W CV	4W CC 5W CV	4W CC 5W CV	4W CC 5W CV
Ø64	-	-	-	-	-	-	-
Ø85 - Ø87	8W CC 9W CV	8W CC 9W CV	2W CC 2,5W CV	2W CC 2,5W CV	8W CC - 9W CV 8W RGBW	8W CC 9W CV	8W CC 9W CV
Ø97	-	-	-	-	-	-	-
Ø125 - Ø127	12W CC 13W CV	12W CC 13W CV	4W CC 5W CV	4W CC 5W CV	12W CC 13W CV	12W CC 13W CV	12W CC 13W CV
Ø138	-	-	-	-	-	-	-
Accessories	HC DL	HC	-	-	HC DL	HC	-
Finish	Glass Alu	Glass Alu	Glass Alu	Black White Grey	Steel Alu	Steel Alu	Steel Alu
CRI 80	2700K 3000K 4000K	2700K 3000K 4000K	2700K 3000K 4000K	2700K 3000K 4000K	2700K 3000K 4000K RGBW	2700K 3000K 4000K	2700K 3000K 4000K
Optic	Spot Flood Wide Flood	Spot Flood Wide Flood	General	General	Spot Flood Wide Flood General Elliptic	Spot Flood Wide Flood	Asymm.

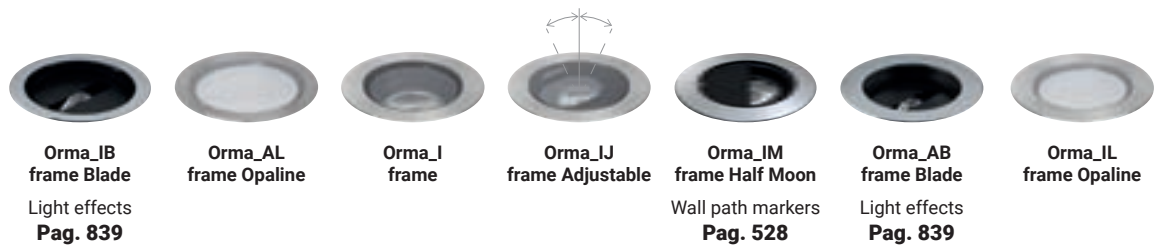
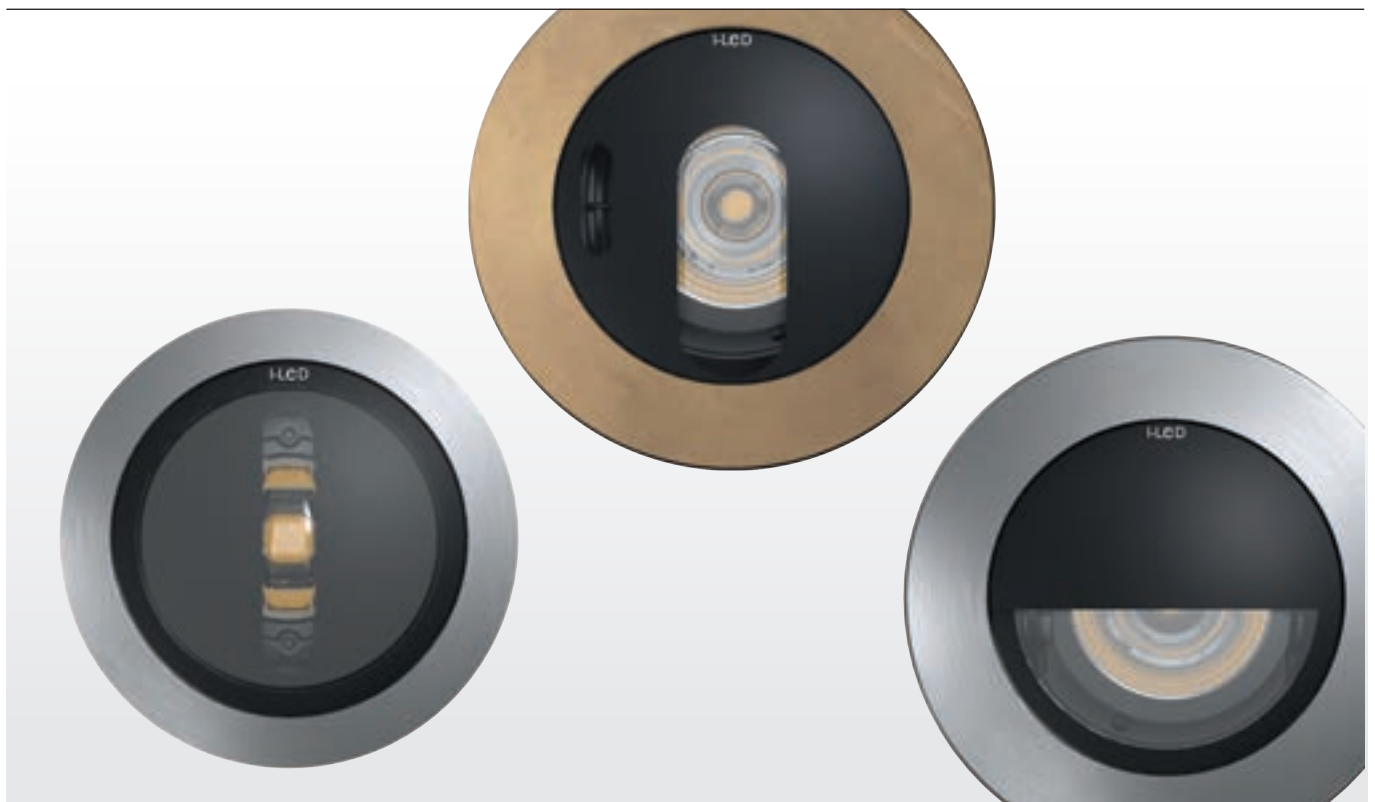

Ø22,5	-	-	-	-	-	-	-
Ø42	-	-	-	-	-	-	-
Ø54 - Ø56	-	1W CC 1,5W CV	-	-	-	-	-
Ø64	-	-	4W CC 5W CV	4W CC 5W CV	4W CC 5W CV	-	1W CC 1,5W CV
Ø85 - Ø87	-	2W CC 2,5W CV	-	-	-	8W CC 9W CV	-
Ø97	8W CC 9W CV	-	8W CC - 9W CV 8W RGBW	8W CC 9W CV	8W CC 9W CV	-	2W CC 2,5W CV
Ø125 - Ø127	-	4W CC 4,5W CV	-	-	-	-	-
Ø138	-	-	12W CC 13W CV	12W CC 13W CV	12W CC 13W CV	-	4W CC 5W CV
Accessories	-	-	HC DL	HC	-	-	-
Finish	Steel Alu	Steel Alu	Steel Alu	Steel Alu Brass Alu	Steel Alu	Steel Alu	Steel Alu
CRI 80	2700K 3000K 4000K	2700K 3000K 4000K	2700K 3000K 4000K RGBW	2700K 3000K 4000K	2700K 3000K 4000K	2700K 3000K 4000K	2700K 3000K 4000K
Optic	E.W.Flood	General	Spot Flood Wide Flood General Elliptic	Spot Flood Wide Flood	Asymm.	E.W.Flood	General

La famille s'agrandit

Orma regroupe au sein de sa famille des systèmes d'éclairage encastrables de tailles compactes, fabriqués avec des matériaux robustes et fiables, garantissant des degrés de protection élevés : IK10 et IP68 (protégé contre l'immersion temporaire). Ainsi, cette gamme se révèle idéale, même lorsque l'espace d'installation est limité. La bride en acier en relief de cette gamme se décline aujourd'hui également dans la finition laiton. La bride encastrée en acier est complétée par la nouvelle version de diffuseur à fleur de sol, entièrement réalisé en verre, et du système d'éclairage de balisage à optique Concentrica. De plus, les versions basculantes peuvent être orientées facilement et rapidement en réglant la vis dédiée à l'aide d'un tournevis plat. Ainsi, nul besoin d'ouvrir le corps de la lampe et de compromettre donc son étanchéité.

Orma est une gamme incroyablement polyvalente, offrant un large champ d'application au concepteur qui pourra combiner ses éléments à souhait, en jouant sur les formes, les finitions et les optiques. À fleur de sol, entièrement en verre ou en métal, Orma s'adapte à tous les contextes, même les plus insolites, grâce à ses 8 diamètres différents parmi lesquels choisir et à sa bride carrée innovante. Au niveau de l'éclairage, de nouveaux optiques ont été introduits: Spot, Flood, Wide Flood, Extra Wide Flood, General, Elliptic, basculant asymétrique avec optique Half Moon.



Optique Blade

L'optique Blade permet d'éclairer les fenêtres, les arcs et les architraves, valorisant ainsi leur forme architecturale et leurs détails. La structure complètement encastrée permet l'ouverture et la fermeture de la fenêtre, sans interférence.

Le faisceau lumineux est très étroit latéralement, puis s'ouvre à presque 180° frontalement, améliorant l'intrados des ouvertures sans éblouissement ni pollution lumineuse.

Pag. 527

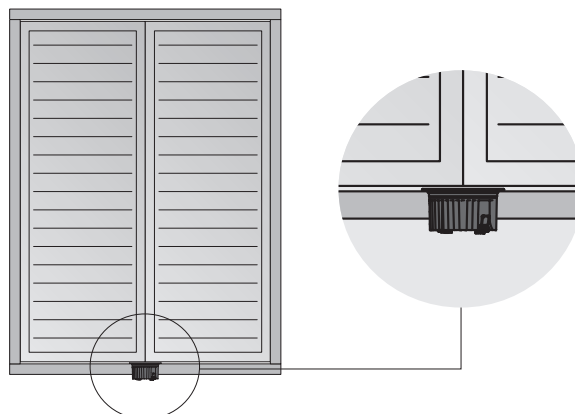
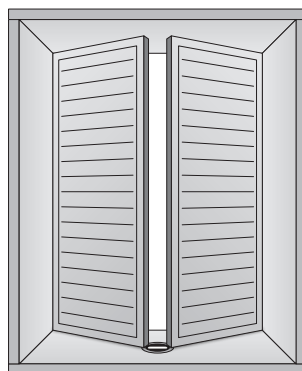
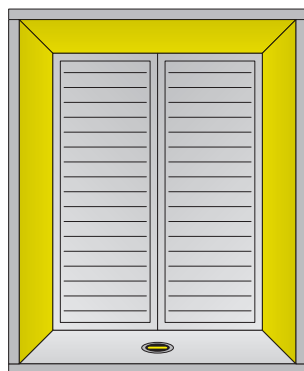

Optique Concentrica

Le système d'éclairage au sol d'allées encastrable et à fleur de sol arbore ce design exclusif. Capable de créer de fascinants effets de lumière et de suivre les allées indiquant ainsi la bonne direction, leur structure se targue d'une capacité de charge jusqu'à 2000 kg, rendant donc ces systèmes carrossables. La famille se compose de quatre diamètres : 42 mm, 56 mm, 87 mm, 127 mm et 5 puissances : 1 W, 1,5 W, 2 W, 2,5 W, 4 W, 5 W. Une gamme étendue et variée à la disposition des professionnels et de leur créativité.

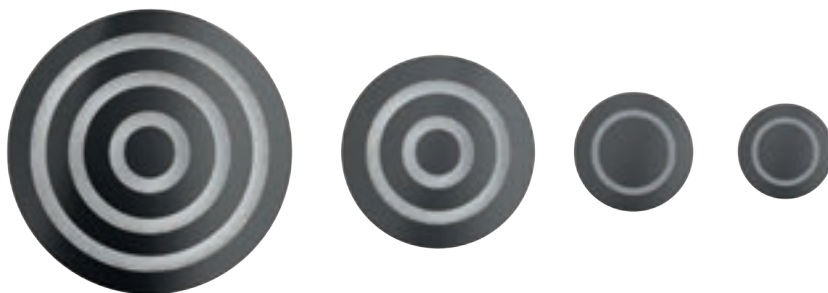

Optique Half Moon

Optique conçu pour une installation encastrée au mur et au sol. Ce système vous permet de créer des chemins de lumière parfaitement signalés et visibles. L'optique Moon vous permet de définir parfaitement le cône de lumière au profit d'un confort visuel élevé et en plus d'être facilement réglable pour vous permettre de l'installer où vous voulez.

Pag. 839

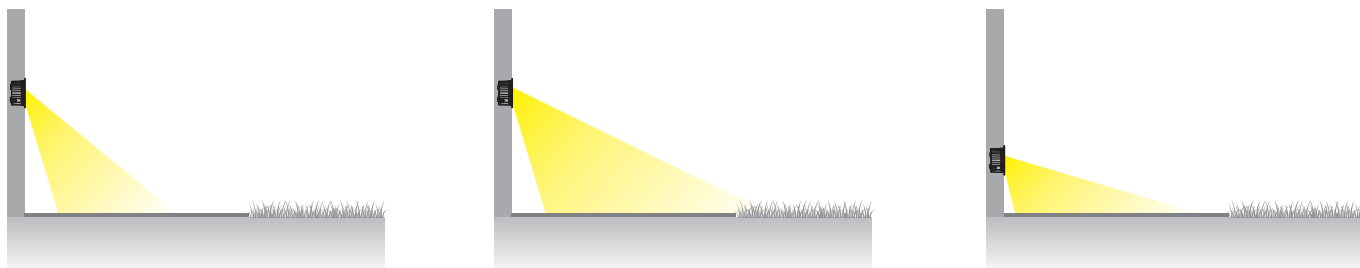

Grâce au système à basculement intégré dans la cage optique, Orma Half Moon s'adapte à différentes hauteurs d'installation et diffuse la lumière jusqu'à 3 mètres de la source.

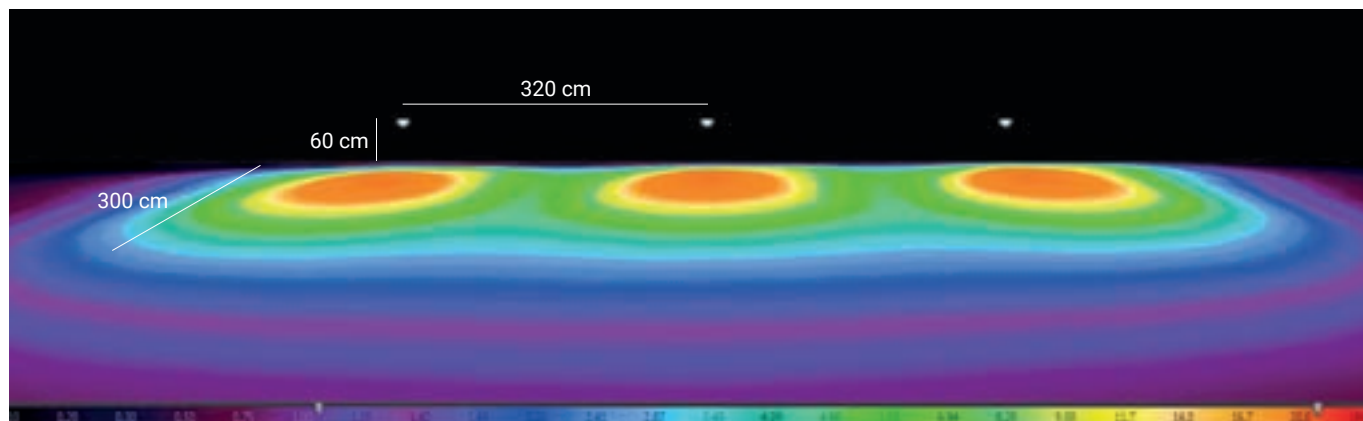

Orma_F | Up-Light | powerLED

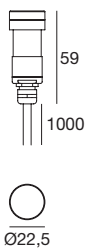

C.C. 1W DC - 350mA	Cct	Im S - D	Optic
Glass Alu 82697	M 2700	136 - On Req	20 Spot -
	W 3000	145 - On Req	35 Flood -
	N 4000	155 - On Req	

Électronique

89419	89421	99183	83100
ON/OFF 1 - 2 art. p 65 x 174 x h 27	ON/OFF 3 - 6 art. p 65 x 174 x h 27	ON/OFF 6 - 12 art. p 80 x 1100 x h 31	DALI 1 - 14 art. p 54 x 1121 x h 26

Boîtier d'encastrement Pag. 610/611

Orma_F | Up-Light | powerLED

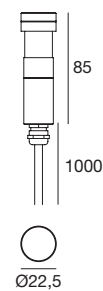

C.V. 1,5W DC - 24 V DC	Cct	Im S - D	Optic
Glass Alu 82698	M 2700	136 - On Req	20 Spot -
	W 3000	145 - On Req	35 Flood -
	N 4000	155 - On Req	

Électronique

89488	89179	89359	99332	99722
ON/OFF 1 - 9 art. p 80 x 1100 x h 31	ON/OFF 1 - 15 art. p 92 x 1117 x h 38	ON/OFF 1 - 30 art. p 115 x 1140 x h 50	0/1-10V 1 - 98 art. p 150 x 160 x h 35	DALI 1 - 78 art. p 191 x 163 x h 38

Boîtier d'encastrement Pag. 610/611

Orma_F | Up-Light | powerLED

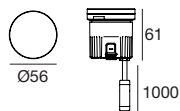

C.C. 4W DC - 350mA	Cct	Im S - D	Optic
Glass Alu 82657	M 2700	490 - On Req	15 Spot -
C.C. 4W DC - 350mA HC	W 3000	490 - On Req	30 Flood -
Glass Alu 82658	N 4000	529 - On Req	60 W.Flood -
C.C. 4W DC - 350mA DL			
Glass Alu 82659			

Électronique

89421	99183	83100
ON/OFF 1 art. p 65 x 174 x h 27	ON/OFF 1 - 2 art. p 80 x 1100 x h 31	DALI 1 - 4 art. p 54 x 1121 x h 26

C.V. 5W DC - 24 V DC	Cct	Im S - D	Optic
Glass Alu 82660	M 2700	490 - On Req	15 Spot -
C.V. 5W DC - 24 V DC HC	W 3000	490 - On Req	30 Flood -
Glass Alu 82661	N 4000	529 - On Req	60 W.Flood -
C.V. 5W DC - 24 V DC DL			
Glass Alu 82662			

Électronique

89488	89179	89359	99332	99722
ON/OFF 1 - 2 art. p 80 x 1100 x h 31	ON/OFF 1 - 4 art. p 92 x 1117 x h 38	ON/OFF 1 - 9 art. p 115 x 1140 x h 50	0/1-10V 1 - 29 art. p 150 x 160 x h 35	DALI 1 - 23 art. p 191 x 163 x h 38

Boîtier d'encastrement Pag. 610/611

Orma_F | Up-Light | ArrayLED

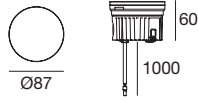

C.C. 8W DC - 220mA	Cct	Im S - D	Optic
Glass Alu 82669	M 2700	1088 - On Req	15 Spot -
C.C. 8W DC - 220mA HC	W 3000	1088 - On Req	30 Flood -
Glass Alu 82670	N 4000	1173 - On Req	60 W.Flood -
C.C. 8W DC - 220mA DL			
Glass Alu 82671			

Électronique

99342	83154
ON/OFF 1 art. p 80 x l 100 x h 31	DALI 1 art. p 54 x l 121 x h 26

C.V. 9W DC - 24 V DC	Cct	Im S - D	Optic
Glass Alu 82672	M 2700	1209 - On Req	15 Spot -
C.V. 9W DC - 24 V DC HC	W 3000	1209 - On Req	30 Flood -
Glass Alu 82673	N 4000	1303 - On Req	60 W.Flood -
C.V. 9W DC - 24 V DC DL			
Glass Alu 82674			

Électronique

89179	89359	99331	99332	99722
ON/OFF 1 - 2 art. p 92 x l 117 x h 38	ON/OFF 1 - 5 art. p 115 x l 140 x h 50	ON/OFF 1 - 15 art. p 150 x l 60 x h 35	0/1-10V 1 - 15 art. p 150 x l 60 x h 35	DALI 1 - 12 art. p 191 x l 63 x h 38

Boîtier d'encastrement Pag. 610/611

Orma_F | Up-Light | ArrayLED

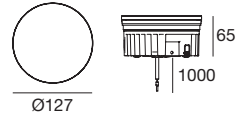

C.C. 12W - 350mA	Cct	Im S - D	Optic
Glass Alu 82683	M 2700	1724 - On Req	15 Spot -
C.C. 12W - 350mA HC	W 3000	1724 - On Req	30 Flood -
Glass Alu 82684	N 4000	1854 - On Req	60 W.Flood -
C.C. 12W - 350mA DL			
Glass Alu 82685			

Électronique

99183	83100
ON/OFF 1 art. p 80 x l 100 x h 31	DALI 1 art. p 54 x l 121 x h 26

C.V. 13W DC - 24 V DC	Cct	Im S - D	Optic
Glass Alu 82686	M 2700	1724 - On Req	15 Spot -
C.V. 13W DC - 24 V DC HC	W 3000	1724 - On Req	30 Flood -
Glass Alu 82687	N 4000	1854 - On Req	60 W.Flood -
C.V. 13W DC - 24 V DC DL			
Glass Alu 82688			

Électronique

89179	89359	99331	99332	99722
ON/OFF 1 art. p 92 x l 117 x h 38	ON/OFF 1 - 3 art. p 115 x l 140 x h 50	ON/OFF 1 - 10 art. p 150 x l 60 x h 35	0/1-10V 1 - 10 art. p 150 x l 60 x h 35	DALI 1 - 8 art. p 191 x l 63 x h 38

Boîtier d'encastrement Pag. 610/611

Orma_FJ | Up-Light | powerLED

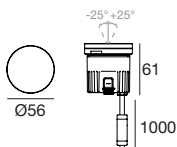

C.C. 4W DC - 350mA	Cct	lm S - D	Optic
Glass /Alu 82663	M 2700	490 - On Req	15 Spot -
	W 3000	490 - On Req	30 Flood -
	N 4000	529 - On Req	60 W.Flood -

Électronique

89421	99183	83100
ON/OFF 1 art. p 65 x l 74 x h 27	ON/OFF 1 - 2 art. p 80 x l 100 x h 31	DALI 1 - 4 art. p 54 x l 121 x h 26

C.V. 5W DC - 24 V DC	Cct	lm S - D	Optic
Glass /Alu 82664	M 2700	490 - On Req	15 Spot -
	W 3000	490 - On Req	30 Flood -
	N 4000	529 - On Req	60 W.Flood -

Électronique

89488	89179	89359	99332	99722
ON/OFF 1 - 2 art. p 80 x l 100 x h 31	ON/OFF 1 - 4 art. p 92 x l 117 x h 38	ON/OFF 1 - 9 art. p 115 x l 140 x h 50	0/1-10V 1 - 29 art. p 150 x l 160 x h 35	DALI 1 - 23 art. p 191 x l 163 x h 38

Boîtier d'encastrement Pag. 610/611

Orma_FJ | Up-Light | ArrayLED

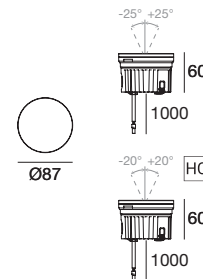

C.C. 8W DC - 220mA	Cct	lm S - D	Optic
Glass /Alu 82675	M 2700	1088 - On Req	15 Spot -
C.C. 8W DC - 220mA HC	W 3000	1088 - On Req	30 Flood -
Glass /Alu 82676	N 4000	1173 - On Req	60 W.Flood -

Électronique

99342	83154
ON/OFF 1 art. p 80 x l 100 x h 31	DALI 1 art. p 54 x l 121 x h 26

C.V. 9W DC - 24 V DC	Cct	lm S - D	Optic
Glass /Alu 82677	M 2700	1209 - On Req	15 Spot -
C.V. 9W DC - 24 V DC HC	W 3000	1209 - On Req	30 Flood -
Glass /Alu 82678	N 4000	1303 - On Req	60 W.Flood -

Électronique

89179	89359	99331	99332	99722
ON/OFF 1 - 2 art. p 92 x l 117 x h 38	ON/OFF 1 - 5 art. p 115 x l 140 x h 50	ON/OFF 1 - 15 art. p 150 x l 160 x h 35	0/1-10V 1 - 15 art. p 150 x l 160 x h 35	DALI 1 - 12 art. p 191 x l 163 x h 38

Boîtier d'encastrement Pag. 610/611

Orma_FJ | Up-Light | ArrayLED

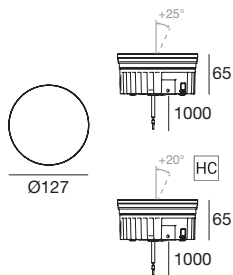

C.C. 12W DC - 350mA	Cct	Im S - D	Optic
Glass /Alu 82689	M 2700	1724 - On Req	15 Spot -
C.C. 12W DC - 350mA HC	W 3000	1724 - On Req	30 Flood -
Glass /Alu 82690	N 4000	1854 - On Req	60 W.Flood -

Électronique

99183	83100
ON/OFF 1 art. p 80 x l 100 x h 31	DALI 1 art. p 54 x l 121 x h 26

C.V. 13W DC - 24 V DC	Cct	Im S - D	Optic
Glass /Alu 82691	M 2700	1724 - On Req	15 Spot -
C.V. 13W DC - 24 V DC HC	W 3000	1724 - On Req	30 Flood -
Glass /Alu 82692	N 4000	1854 - On Req	60 W.Flood -

Électronique

89179	89359	99331	99332	99722
ON/OFF 1 art. p 92 x l 117 x h 38	ON/OFF 1 - 3 art. p 115 x l 140 x h 50	ON/OFF 1 - 10 art. p 150 x l 60 x h 35	0/1-10V 1 - 10 art. p 150 x l 60 x h 35	DALI 1 - 8 art. p 191 x l 63 x h 38

Boîtier d'encastrement Pag. 610/611

Orma_FL | Up-Light | powerLED

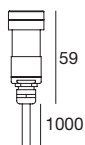

C.C. 1W DC - 350mA	Cct	Im S - D	Optic
Glass / Alu 82699	M 2700	136 - On Req	00 General -
	W 3000	145 - On Req	
	N 4000	155 - On Req	

Électronique

89419	89421	99183	83100
ON/OFF 1 - 2 art. p 65 x l 74 x h 27	ON/OFF 3 - 6 art. p 65 x l 74 x h 27	ON/OFF 6 - 12 art. p 80 x l 100 x h 31	DALI 1 - 14 art. p 54 x l 121 x h 26

Boîtier d'encastrement Pag. 610/611

Orma_FL | Up-Light | powerLED

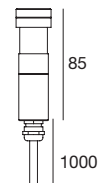

C.V. 1,5W DC - 24 V DC	Cct	Im S - D	Optic
Glass / Alu 82700	M 2700	136 - On Req	00 General -
	W 3000	145 - On Req	
	N 4000	155 - On Req	

Électronique

89488	89179	89359	99332	99722
ON/OFF 1 - 9 art. p 80 x l 100 x h 31	ON/OFF 1 - 15 art. p 92 x l 117 x h 38	ON/OFF 1 - 30 art. p 115 x l 140 x h 50	0/1-10V 1 - 98 art. p 150 x l 60 x h 35	DALI 1 - 78 art. p 191 x l 63 x h 38

Boîtier d'encastrement Pag. 610/611

Orma_FL | Path-Marker | powerLED

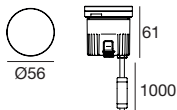

C.C. 1W DC - 350mA	Cct	Im S - D	Optic
Glass / Alu 82667	M 2700	136 - On Req	00 General -
	W 3000	145 - On Req	
	N 4000	155 - On Req	

Électronique

89420	99179	99186	83102
ON/OFF 1 - 2 art. p 65 x l 74 x h 27	ON/OFF 3 - 6 art. p 80 x l 100 x h 31	ON/OFF 6 - 12 art. p 92 x l 117 x h 38	DALI 1 - 14 art. p 54 x l 121 x h 26

C.V. 1,5W DC - 24 V DC	Cct	Im S - D	Optic
Glass / Alu 82668	M 2700	136 - On Req	00 General -
	W 3000	145 - On Req	
	N 4000	155 - On Req	

Électronique

89488	89179	89359	99332	99722
ON/OFF 1 - 9 art. p 80 x l 100 x h 31	ON/OFF 1 - 15 art. p 92 x l 117 x h 38	ON/OFF 1 - 30 art. p 115 x l 140 x h 50	0/1-10V 1 - 98 art. p 150 x l 60 x h 35	DALI 1 - 78 art. p 191 x l 63 x h 38

Boîtier d'encastrement Pag. 610/611

Orma_FL | Path-Marker | powerLED

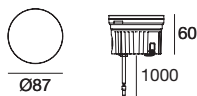

C.C. 2W DC- 630mA	Cct	lm S - D	Optic
Glass Alu 82681	M 2700	249 - On Req	00 General -
	W 3000	266 - On Req	
	N 4000	284 - On Req	

Électronique

89420	99179	99186	83102
ON/OFF 1- 2 art. p 65 x l 174 x h 27	ON/OFF 3- 6 art. p 80 x l 100 x h 31	ON/OFF 6- 12 art. p 92 x l 117 x h 38	DALI 1- 14 art. p 54 x l 121 x h 26

C.V. 2,5W DC - 24 V DC	Cct	lm S - D	Optic
Glass Alu 82682	M 2700	249 - On Req	00 General -
	W 3000	266 - On Req	
	N 4000	284 - On Req	

Électronique

89488	89179	89359	99332	99722
ON/OFF 1- 5 art. p 80 x l 100 x h 31	ON/OFF 1- 9 art. p 92 x l 117 x h 38	ON/OFF 1- 18 art. p 115 x l 140 x h 50	0/1-10V 1- 56 art. p 150 x l 60 x h 35	DALI 1- 45 art. p 191 x l 63 x h 38

Boîtier d'encastrement Pag. 610/611

Orma_FL | Path-Marker | powerLED

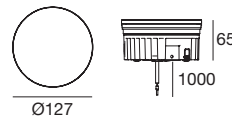

C.C. 4W DC - 350mA	Cct	lm S - D	Optic
Glass Alu 82695	M 2700	490 - On Req	00 General -
	W 3000	490 - On Req	
	N 4000	529 - On Req	

Électronique

89421	99183	83100
ON/OFF 1 art. p 65 x l 174 x h 27	ON/OFF 1- 2 art. p 80 x l 100 x h 31	DALI 1- 4 art. p 54 x l 121 x h 26

C.V. 5W DC - 24 V DC	Cct	lm S - D	Optic
Glass Alu 82696	M 2700	490 - On Req	00 General -
	W 3000	490 - On Req	
	N 4000	529 - On Req	

Électronique

89488	89179	89359	99332	99722
ON/OFF 1- 2 art. p 80 x l 100 x h 31	ON/OFF 1- 4 art. p 92 x l 117 x h 38	ON/OFF 1- 9 art. p 115 x l 140 x h 50	0/1-10V 1- 29 art. p 150 x l 60 x h 35	DALI 1- 23 art. p 191 x l 63 x h 38

Boîtier d'encastrement Pag. 610/611

Orma_FO | Drive-over spotlights | 24 V DC | topLED 1,5 W DC

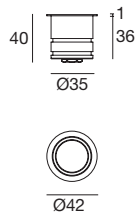
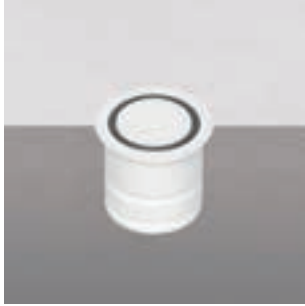
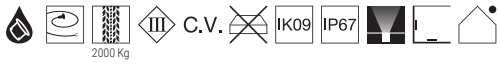

	Cct	Im S - D	Optic
White 95474	M 2700	54 - On Req	00 General
Black 95475	W 3000	60 - On Req	
Grey 95476	N 4000	63 - On Req	

Électronique

89488	89179	89359	99332	99722
ON/OFF 1-9 art. p 80 x l 100 x h 31	ON/OFF 1-15 art. p 92 x l 117 x h 38	ON/OFF 1-30 art. p 115 x l 140 x h 50	0/1-10V 1-98 art. p 150 x l 160 x h 35	DALI 1-78 art. p 191 x l 63 x h 38

Boîtier d'encastrement Pag. 610/611

Orma_FO | Up-Light | powerLED

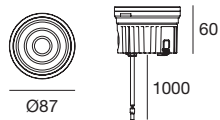
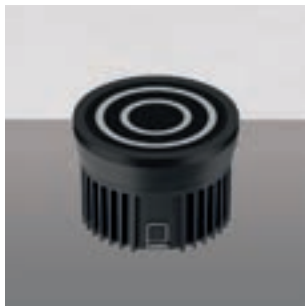

C.C. 2W DC - 630mA	Cct	Im S - D	Optic
Black 82679	M 2700	249 - On Req	00 General -
	W 3000	266 - On Req	
	N 4000	284 - On Req	

Électronique

89420	99179	99186	83102
ON/OFF 1-2 art. p 65 x l 74 x h 27	ON/OFF 3-6 art. p 80 x l 100 x h 31	ON/OFF 6-12 art. p 92 x l 117 x h 38	DALI 1-14 art. p 54 x l 121 x h 26

C.V. 2,5W DC - 24 V DC	Cct	Im S - D	Optic
Black 82680	M 2700	249 - On Req	00 General -
	W 3000	266 - On Req	
	N 4000	284 - On Req	

Électronique

89488	89179	89359	99332	99722
ON/OFF 1-5 art. p 80 x l 100 x h 31	ON/OFF 1-9 art. p 92 x l 117 x h 38	ON/OFF 1-18 art. p 115 x l 140 x h 50	0/1-10V 1-56 art. p 150 x l 160 x h 35	DALI 1-45 art. p 191 x l 63 x h 38

Boîtier d'encastrement Pag. 610/611

Orma_FO | Up-Light | powerLED

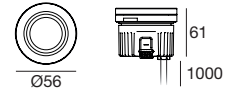

C.C. 1W DC - 350mA	Cct	Im S - D	Optic
Black 82665	M 2700	136 - On Req	00 General -
	W 3000	145 - On Req	
	N 4000	155 - On Req	

Électronique

89419	89421	99183	83100
ON/OFF 1-2 art. p 65 x l 74 x h 27	ON/OFF 3-6 art. p 80 x l 100 x h 31	ON/OFF 6-12 art. p 92 x l 117 x h 38	DALI 1-14 art. p 54 x l 121 x h 26

C.V. 1,5W DC - 24 V DC	Cct	Im S - D	Optic
Black 82666	M 2700	136 - On Req	00 General -
	W 3000	145 - On Req	
	N 4000	155 - On Req	

Électronique

89488	89179	89359	99332	99722
ON/OFF 1-9 art. p 80 x l 100 x h 31	ON/OFF 1-15 art. p 92 x l 117 x h 38	ON/OFF 1-30 art. p 115 x l 140 x h 50	0/1-10V 1-98 art. p 150 x l 160 x h 35	DALI 1-78 art. p 191 x l 63 x h 38

Boîtier d'encastrement Pag. 610/611

Orma_FO | Up-Light | powerLED

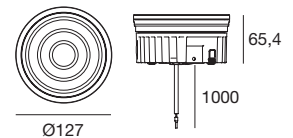

C.C. 4W DC - 350mA	Cct	Im S - D	Optic
Black 82693	M 2700	490 - On Req	00 General -
	W 3000	490 - On Req	
	N 4000	529 - On Req	

Électronique

89421	99183	83100
ON/OFF 1 art. p 65 x l 74 x h 27	ON/OFF 1-2 art. p 80 x l 100 x h 31	DALI 1-4 art. p 54 x l 121 x h 26

C.V. 5W DC - 24 V DC	Cct	Im S - D	Optic
Black 82694	M 2700	490 - On Req	00 General -
	W 3000	490 - On Req	
	N 4000	529 - On Req	

Électronique

89488	89179	89359	99332	99722
ON/OFF 1-2 art. p 80 x l 100 x h 31	ON/OFF 1-4 art. p 92 x l 117 x h 38	ON/OFF 1-9 art. p 115 x l 140 x h 50	0/1-10V 1-29 art. p 150 x l 160 x h 35	DALI 1-23 art. p 191 x l 63 x h 38

Boîtier d'encastrement Pag. 610/611



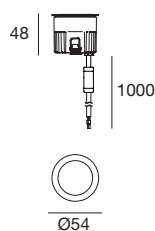

C.C. 4W DC - 350mA		Cct	Im S - D	Optic
Steel/Alu	81181	M 2700	490 - 270	15 Spot (22°)
		W 3000	490 - 270	30 Flood (29°)
		N 4000	529 - 292	60 W.Flood (48°)
				25 Elliptic -

HC		Cct	Im S - D	Optic
Steel/Alu	81182	M 2700	490 - 186	15 Spot (20°)
		W 3000	490 - 186	30 Flood (25°)
		N 4000	529 - 201	60 Flood (37°)

DL		Cct	Im S - D	Optic
Steel/Alu	81183	M 2700	490 - 193	15 Spot (22°)
		W 3000	490 - 193	30 Flood (30°)
		N 4000	529 - 208	60 W.Flood (55°)

Électronique

89421	99183	83100
ON/OFF 1 art. p 65 x l 74 x h 27	ON/OFF 1 - 2 art. p 80 x l 100 x h 31	DALI 1 - 4 art. p 54 x l 121 x h 26

C.V. 5W DC - 24 V DC		Cct	Im S - D	Optic
Steel/Alu	81184	M 2700	490 - 270	15 Spot (22°)
		W 3000	490 - 270	30 Flood (29°)
		N 4000	529 - 292	60 W.Flood (48°)
				25 Elliptic -

HC		Cct	Im S - D	Optic
Steel/Alu	81185	M 2700	490 - 186	15 Spot (20°)
		W 3000	490 - 186	30 Flood (25°)
		N 4000	529 - 201	60 Flood (37°)

DL		Cct	Im S - D	Optic
Steel/Alu	81186	M 2700	490 - 193	15 Spot (22°)
		W 3000	490 - 193	30 Flood (30°)
		N 4000	529 - 208	60 W.Flood (55°)

Électronique

89488	89179	89359	99332	99722
ON/OFF 1 - 2 art. p 80 x l 100 x h 31	ON/OFF 1 - 4 art. p 92 x l 117 x h 38	ON/OFF 1 - 9 art. p 115 x l 140 x h 50	0/1-10V 1 - 29 art. p 150 x l 160 x h 35	DALI 1 - 23 art. p 191 x l 163 x h 38

Boîtier d'encastrement Pag. 610/611

RTG 81181W15 / 81181W30

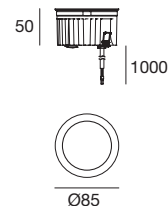

C.C. - 8W DC - 220 mA		Cct	Im S - D	Optic
Steel/Alu	81187	M 2700	1088 - 858	15 Spot (15°)
		W 3000	1088 - 894	30 Flood (31°)
		N 4000	1173 - 944	60 W.Flood (61°)

HC		Cct	Im S - D	Optic
Steel/Alu	81188	M 2700	1088 - 619	15 Spot (15°)
		W 3000	1088 - 645	30 Flood (27°)
		N 4000	1173 - 681	60 W.Flood (49°)

DL		Cct	Im S - D	Optic
Steel/Alu	81189	M 2700	1088 - 575	15 Spot (16°)
		W 3000	1088 - 599	30 Flood (29°)
		N 4000	1173 - 633	60 W.Flood (53°)

Électronique

99342	83154
ON/OFF 1 art. p 80 x l 100 x h 31	DALI 1 art. p 54 x l 121 x h 26

C.V. 9W DC - 24 V DC		Cct	Im S - D	Optic
Steel/Alu	81190	M 2700	1209 - 954	15 Spot (15°)
		W 3000	1209 - 996	30 Flood (31°)
		N 4000	1303 - 1052	60 W.Flood (61°)

HC		Cct	Im S - D	Optic
Steel/Alu	81191	M 2700	1209 - 687	15 Spot (15°)
		W 3000	1209 - 716	30 Flood (27°)
		N 4000	1303 - 756	60 W.Flood (49°)

DL		Cct	Im S - D	Optic
Steel/Alu	81192	M 2700	1209 - 639	15 Spot (16°)
		W 3000	1209 - 666	30 Flood (29°)
		N 4000	1303 - 703	60 W.Flood (53°)

Électronique

89179	89359	99331	99332	99722
ON/OFF 1 - 2 art. p 92 x l 117 x h 38	ON/OFF 1 - 5 art. p 115 x l 140 x h 50	ON/OFF 1 - 15 art. p 150 x l 160 x h 35	0/1-10V 1 - 15 art. p 150 x l 160 x h 35	DALI 1 - 12 art. p 191 x l 163 x h 38

RGBW - 8W DC - 630 mA		Cct	Optic
Steel/Alu	81322	Q RGBW natural white	06 N.Spot -
		V RGBW warm white	15 Spot -
			45 W.Flood -
			00 General -

Électronique

99743 + 99702	99333	DMX	Driver	Switching
Dimmer RF 1 - 12 art.	Dimmer DMX 2 - 12 art.	DMX Controllers CV 24V/48V Pag. 952 - 953	Driver CV 48V Pag. 941	Switching CV 48V Pag. 932

Boîtier d'encastrement Pag. 610/611

RTG 81187W30

Orma_A | Up-Light | arrayLED

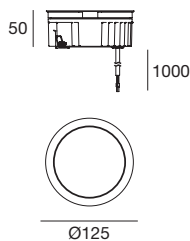

C.C. 12W DC - 350mA		Cct	lm S - D	Optic
Steel/Alu	81193	M 2700	1724 - 1379	15 Spot (14°)
		W 3000	1724 - 1379	30 Flood (31°)
		N 4000	1854 - 1485	60 W.Flood (60°)

HC		Cct	lm S - D	Optic
Steel/Alu	81194	M 2700	1724 - 981	15 Spot (14°)
		W 3000	1724 - 981	30 Flood (28°)
		N 4000	1854 - 1055	60 W.Flood (49°)

DL		Cct	lm S - D	Optic
Steel/Alu	81195	M 2700	1724 - 1094	15 Spot (14°)
		W 3000	1724 - 1094	30 Flood (30°)
		N 4000	1854 - 1178	60 W.Flood (52°)

Électronique

99183	83100
ON/OFF 1 art. p 80 x l 100 x h 31	DALI 1 art. p 54 x l 121 x h 26

C.V. 13W DC - 24 V DC		Cct	lm S - D	Optic
Steel/Alu	81196	M 2700	1724 - 1379	15 Spot (14°)
		W 3000	1724 - 1379	30 Flood (31°)
		N 4000	1854 - 1485	60 W.Flood (60°)

HC		Cct	lm S - D	Optic
Steel/Alu	81197	M 2700	1724 - 981	15 Spot (14°)
		W 3000	1724 - 981	30 Flood (28°)
		N 4000	1854 - 1055	60 W.Flood (49°)

DL		Cct	lm S - D	Optic
Steel/Alu	81198	M 2700	1724 - 1094	15 Spot (14°)
		W 3000	1724 - 1094	30 Flood (30°)
		N 4000	1854 - 1178	60 W.Flood (52°)

Électronique

89179	89359	99331	99332	99722
ON/OFF 1 art. p 92 x l 117 x h 38	ON/OFF 1 - 3 art. p 115 x l 140 x h 50	ON/OFF 1 - 10 art. p 150 x l 60 x h 35	0/1-10V 1 - 10 art. p 150 x l 60 x h 35	DALI 1 - 8 art. p 191 x l 63 x h 38

Boîtier d'encastrement Pag. 610/611

Orma_AJ | Up-Light | powerLED

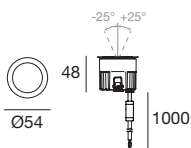

C.C. 4W DC - 350mA	Cct	Im S - D	Optic
Steel Alu 81205	M 2700	490 - 270	15 Spot (22°)
	W 3000	490 - 270	30 Flood (29°)
	N 4000	529 - 292	60 W.Flood (48°)

Électronique

89421	99183	83100
ON/OFF 1 art. p 65 x l 74 x h 27	ON/OFF 1 - 2 art. p 80 x l 100 x h 31	DALI 1 - 4 art. p 54 x l 121 x h 26

C.V. 5W DC - 24 V DC	Cct	Im S - D	Optic
Steel Alu 81206	M 2700	490 - 270	15 Spot (22°)
	W 3000	490 - 270	30 Flood (29°)
	N 4000	529 - 292	60 W.Flood (48°)

Électronique

89488	89179	89359	99332	99722
ON/OFF 1 - 2 art. p 80 x l 100 x h 31	ON/OFF 1 - 4 art. p 92 x l 117 x h 38	ON/OFF 1 - 9 art. p 115 x l 140 x h 50	0/1-10V 1 - 29 art. p 150 x l 60 x h 35	DALI 1 - 23 art. p 191 x l 63 x h 38

Boîtier d'encastrement Pag. 610/611

Orma_AJ | Up-Light | arrayLED

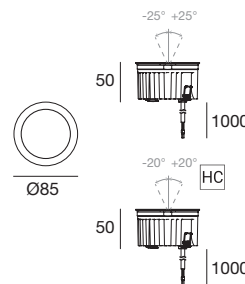

C.C. - 8W DC - 220 mA	Cct	Im S - D	Optic
Steel Alu 81207	M 2700	1088 - 858	15 Spot (15°)
	W 3000	1088 - 894	30 Flood (31°)
	N 4000	1173 - 944	60 W.Flood (61°)

C.C. - 8W DC - 220 mA HC	Cct	Im S - D	Optic
Steel Alu 82460	M 2700	1088 - 619	15 Spot -
	W 3000	1088 - 645	30 Flood -
	N 4000	1173 - 681	60 W.Flood -

Électronique

99342	83154
ON/OFF 1 art. p 80 x l 100 x h 31	DALI 1 art. p 54 x l 121 x h 26

C.V. 9W DC - 24 V DC	Cct	Im S - D	Optic
Steel Alu 81208	M 2700	1209 - 954	15 Spot (15°)
	W 3000	1209 - 996	30 Flood (31°)
	N 4000	1303 - 1052	60 W.Flood (61°)

C.V. 9W DC - 24 V DC HC	Cct	Im S - D	Optic
Steel Alu 82461	M 2700	1209 - 687	15 Spot -
	W 3000	1209 - 716	30 Flood -
	N 4000	1303 - 756	60 W.Flood -

Électronique

89179	89359	99331	99332	99722
ON/OFF 1 - 2 art. p 92 x l 117 x h 38	ON/OFF 1 - 5 art. p 115 x l 140 x h 50	ON/OFF 1 - 15 art. p 150 x l 60 x h 35	0/1-10V 1 - 15 art. p 150 x l 60 x h 35	DALI 1 - 12 art. p 191 x l 63 x h 38

Boîtier d'encastrement Pag. 610/611

Orma_AJ | Up-Light | arrayLED

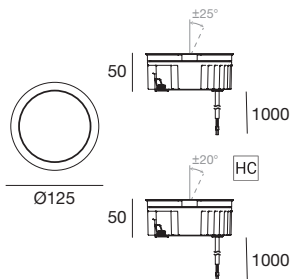

C.C. - 12W DC - 350 mA	Cct	lm S - D	Optic
Steel/Alu 81209	M 2700	1724 - 1317	15 Spot (22°)
	W 3000	1724 - 1317	30 Flood (34°)
	N 4000	1854 - 1417	60 W.Floos (61°)

C.C. - 12W DC - 350 mA ^{HC}	Cct	lm S - D	Optic
Steel/Alu 82462	M 2700	1724 - 935	15 Spot -
	W 3000	1724 - 935	30 Flood -
	N 4000	1854 - 1005	60 W.Flood -

Électronique

99183 83100

ON/OFF DALI
1 art. 1 art.
p 80 x l 100 x h 31 p 54 x l 121 x h 26

C.V. 13W DC - 24 V DC	Cct	lm S - D	Optic
Steel/Alu 81210	M 2700	1724 - 1317	15 Spot (22°)
	W 3000	1724 - 1317	30 Flood (34°)
	N 4000	1854 - 1417	60 W.Floos (61°)

C.V. 13W DC - 24 V DC ^{HC}	Cct	lm S - D	Optic
Steel/Alu 82463	M 2700	1724 - 935	15 Spot -
	W 3000	1724 - 935	30 Flood -
	N 4000	1854 - 1005	60 W.Flood -

Électronique

89179 89359 99331 99332 99722

ON/OFF ON/OFF ON/OFF 0/1-10V DALI
1 art. 1 - 3 art. 1 - 10 art. 1 - 10 art. 1 - 8 art.
p 92 x l 117 x h 38 p 115 x l 140 x h 50 p 150 x l 60 x h 35 p 150 x l 60 x h 35 p 191 x l 63 x h 38

Boîtier d'encastrement Pag. 610/611

Orma_AL | Path-Marker | powerLED

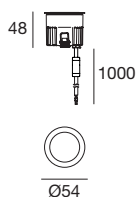

C.C. 1W DC - 350mA	Cct	lm S - D	Optic
Steel/Alu 81217	M 2700	136 - 16	00 General (117°)
	W 3000	145 - 18	
	N 4000	155 - 19	

Électronique

89419	89421	99183	83100
ON/OFF 1 - 2 art. p 65 x l 74 x h 27	ON/OFF 3 - 6 art. p 65 x l 74 x h 27	ON/OFF 6 - 12 art. p 80 x l 100 x h 31	DALI 1 - 14 art. p 54 x l 121 x h 26

C.V. 1,5W DC - 24 V DC	Cct	lm S - D	Optic
Steel/Alu 81218	M 2700	136 - 16	00 General (117°)
	W 3000	145 - 18	
	N 4000	155 - 19	

Électronique

89488	89179	89359	99332	99722
ON/OFF 1 - 9 art. p 80 x l 100 x h 31	ON/OFF 1 - 15 art. p 92 x l 117 x h 38	ON/OFF 1 - 30 art. p 115 x l 140 x h 50	0/1-10V 1 - 98 art. p 150 x l 160 x h 35	DALI 1 - 78 art. p 191 x l 163 x h 38

Boîtier d'encastrement Pag. 610/611

Orma_AL | Path-Marker | powerLED

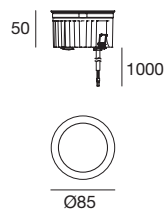

C.C. 2W DC - 630 mA	Cct	lm S - D	Optic
Steel/Alu 81219	M 2700	249 - 24	00 General (118°)
	W 3000	266 - 26	
	N 4000	284 - 28	

Électronique

89420	99179	99186	83102
ON/OFF 1 - 2 art. p 65 x l 74 x h 27	ON/OFF 3 - 6 art. p 80 x l 100 x h 31	ON/OFF 6 - 12 art. p 92 x l 117 x h 38	DALI 1 - 14 art. p 54 x l 121 x h 26

C.V. 2,5W DC - 24 V DC	Cct	lm S - D	Optic
Steel/Alu 81220	M 2700	249 - 24	00 General (118°)
	W 3000	266 - 26	
	N 4000	284 - 28	

Électronique

89488	89179	89359	99332	99722
ON/OFF 1 - 5 art. p 80 x l 100 x h 31	ON/OFF 1 - 9 art. p 92 x l 117 x h 38	ON/OFF 1 - 18 art. p 115 x l 140 x h 50	0/1-10V 1 - 56 art. p 150 x l 160 x h 35	DALI 1 - 45 art. p 191 x l 163 x h 38

Boîtier d'encastrement Pag. 610/611

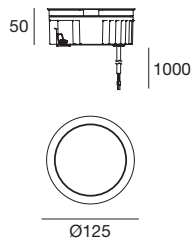

C.C. 4W DC - 350mA	Cct	Im S - D	Optic
Steel/Alu 81221	M 2700	490 - 89	00 General (116°)
	W 3000	490 - 89	
	N 4000	529 - 96	

Électronique

89421	99183	83100
ON/OFF 1 art. p 65 x l 74 x h 27	ON/OFF 1 - 2 art. p 80 x l 100 x h 31	DALI 1 - 4 art. p 54 x l 121 x h 26

C.V. 4,5W DC - 24 V DC	Cct	Im S - D	Optic
Steel/Alu 81222	M 2700	490 - 89	00 General (116°)
	W 3000	490 - 89	
	N 4000	529 - 96	

Électronique

89488	89179	89359	99332	99722
ON/OFF 1 - 2 art. p 80 x l 100 x h 31	ON/OFF 1 - 4 art. p 92 x l 117 x h 38	ON/OFF 1 - 9 art. p 115 x l 140 x h 50	0/1-10V 1 - 29 art. p 150 x l 160 x h 35	DALI 1 - 23 art. p 191 x l 163 x h 38

Boîtier d'encastrement Pag. 610/611

Orma_I | Up-Light | powerLED

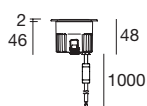
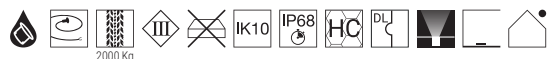

C.C. 4W DC - 350mA	Cct	Im S - D	Optic
Steel Alu 80582	M 2700	490 - 270	15 Spot (22°)
	W 3000	490 - 270	30 Flood (29°)
	N 4000	529 - 292	60 W.Flood (48°)
			25 Elliptic -

C.C. 4W DC - 350mA ^{HC}	Cct	Im S - D	Optic
Steel Alu 80583	M 2700	490 - 186	15 Spot (20°)
	W 3000	490 - 186	30 Flood (25°)
	N 4000	529 - 201	60 Flood (37°)

C.C. 4W DC - 350mA ^{DL}	Cct	Im S - D	Optic
Steel Alu 80584	M 2700	490 - 193	15 Spot (22°)
	W 3000	490 - 193	30 Flood (30°)
	N 4000	529 - 208	60 W.Flood (55°)

Électronique

89421	99183	83100
ON/OFF 1 art. p 65 x l 74 x h 27	ON/OFF 1 - 2 art. p 80 x l 100 x h 31	DALI 1 - 4 art. p 54 x l 121 x h 26

C.V. 5W DC - 24 V DC	Cct	Im S - D	Optic
Steel Alu 80585	M 2700	490 - 270	15 Spot (22°)
	W 3000	490 - 270	30 Flood (29°)
	N 4000	529 - 292	60 W.Flood (48°)
			25 Elliptic -

C.V. 5W DC - 24 V DC ^{HC}	Cct	Im S - D	Optic
Steel Alu 80586	M 2700	490 - 186	15 Spot (20°)
	W 3000	490 - 186	30 Flood (25°)
	N 4000	529 - 201	60 Flood (37°)

C.V. 5W DC - 24 V DC ^{DL}	Cct	Im S - D	Optic
Steel Alu 80587	M 2700	490 - 193	15 Spot (22°)
	W 3000	490 - 193	30 Flood (30°)
	N 4000	529 - 208	60 W.Flood (55°)

Électronique

89488	89179	89359	99332	99722
ON/OFF 1 - 2 art. p 80 x l 100 x h 31	ON/OFF 1 - 4 art. p 92 x l 117 x h 38	ON/OFF 1 - 9 art. p 115 x l 140 x h 50	0/1-10V 1 - 29 art. p 150 x l 160 x h 35	DALI 1 - 23 art. p 191 x l 163 x h 38

Boîtier d'encastrement Pag. 610/611

RTG 80582W30

Orma_I | Up-Light | arrayLED

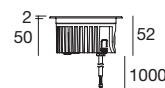
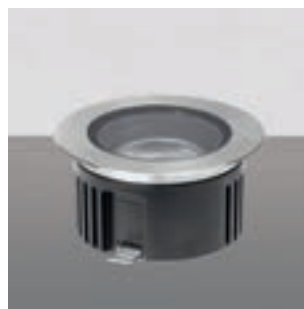
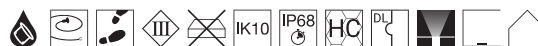

C.C. - 8W DC - 220 mA	Cct	Im S - D	Optic
Steel Alu 80588	M 2700	1088 - 858	15 Spot (15°)
	W 3000	1088 - 894	30 Flood (31°)
	N 4000	1173 - 944	60 W.Flood (61°)

C.C. - 8W DC - 220 mA ^{HC}	Cct	Im S - D	Optic
Steel Alu 80589	M 2700	1088 - 619	15 Spot (15°)
	W 3000	1088 - 645	30 Flood (27°)
	N 4000	1173 - 681	60 W.Flood (49°)

C.C. - 8W DC - 220 mA ^{DL}	Cct	Im S - D	Optic
Steel Alu 80590	M 2700	1088 - 575	15 Spot (16°)
	W 3000	1088 - 599	30 Flood (29°)
	N 4000	1173 - 633	60 W.Flood (53°)

Électronique

99342	83154
ON/OFF 1 art. p 80 x l 100 x h 31	DALI 1 art. p 54 x l 121 x h 26

C.V. 9W DC - 24 V DC	Cct	Im S - D	Optic
Steel Alu 81172	M 2700	1209 - 954	15 Spot (15°)
	W 3000	1209 - 996	30 Flood (31°)
	N 4000	1303 - 1052	60 W.Flood (61°)

C.V. 9W DC - 24 V DC ^{HC}	Cct	Im S - D	Optic
Steel Alu 81173	M 2700	1209 - 687	15 Spot (15°)
	W 3000	1209 - 716	30 Flood (27°)
	N 4000	1303 - 756	60 W.Flood (49°)

C.V. 9W DC - 24 V DC ^{DL}	Cct	Im S - D	Optic
Steel Alu 81174	M 2700	1209 - 639	15 Spot (16°)
	W 3000	1209 - 666	30 Flood (29°)
	N 4000	1303 - 703	60 W.Flood (53°)

Électronique

89179	89359	99331	99332	99722
ON/OFF 1 - 2 art. p 92 x l 117 x h 38	ON/OFF 1 - 5 art. p 115 x l 140 x h 50	ON/OFF 1 - 15 art. p 150 x l 160 x h 35	0/1-10V 1 - 15 art. p 150 x l 160 x h 35	DALI 1 - 12 art. p 191 x l 163 x h 38

RGBW - 8W DC - 630 mA	Cct	Optic
Steel Alu 81321	Q RGBW natural white	06 N.Spot -
	V RGBW warm white	15 Spot -
		45 W.Flood -
		00 General -

Électronique

99743 + 99702	99333	DMX	Driver	Switching
Dimmer RF 1 - 12 art.	Dimmer DMX 2 - 12 art.	DMX Controllers CV 24V/48V Pag. 952 - 953	Driver CV 48V Pag. 941	Switching CV 48V Pag. 932

Boîtier d'encastrement Pag. 610/611

RTG 80588W30 / 81321V45

Orma_I | Up-Light | arrayLED

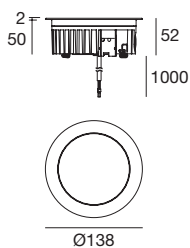

C.C. 12W DC - 350mA		Cct	lm S - D	Optic	
Steel/Alu	81175	M 2700	1724 - 1379	15 Spot	(14°)
		W 3000	1724 - 1379	30 Flood	(31°)
		N 4000	1854 - 1485	60 W.Flood	(60°)

C.C. 12W DC - 350mA HC		Cct	lm S - D	Optic	
Steel/Alu	81176	M 2700	1724 - 981	15 Spot	(14°)
		W 3000	1724 - 981	30 Flood	(28°)
		N 4000	1854 - 1055	60 W.Flood	(49°)

C.C. 12W DC - 350mA DL		Cct	lm S - D	Optic	
Steel/Alu	81177	M 2700	1724 - 1094	15 Spot	(14°)
		W 3000	1724 - 1094	30 Flood	(30°)
		N 4000	1854 - 1178	60 W.Flood	(52°)

Électronique

99183 **83100**

ON/OFF DALI
1 art. 1 art.
p 80 x l 100 x h 31 p 54 x l 121 x h 26

C.V. 13W DC - 24 V DC		Cct	lm S - D	Optic	
Steel/Alu	81178	M 2700	1724 - 1379	15 Spot	(14°)
		W 3000	1724 - 1397	30 Flood	(31°)
		N 4000	1854 - 1485	60 W.Flood	(60°)

C.V. 13W DC - 24 V DC HC		Cct	lm S - D	Optic	
Steel/Alu	81179	M 2700	1724 - 981	15 Spot	(14°)
		W 3000	1724 - 981	30 Flood	(28°)
		N 4000	1854 - 1055	60 W.Flood	(49°)

C.V. 13W DC - 24 V DC DL		Cct	lm S - D	Optic	
Steel/Alu	81180	M 2700	1724 - 1094	15 Spot	(14°)
		W 3000	1724 - 1094	30 Flood	(30°)
		N 4000	1854 - 1178	60 W.Flood	(52°)

Électronique

89179 **89359** **99331** **99332** **99722**

ON/OFF ON/OFF ON/OFF 0/1-10V DALI
1 art. 1 - 3 art. 1 - 10 art. 1 - 10 art. 1 - 8 art.
p 92 x l 117 x h 38 p 115 x l 140 x h 50 p 150 x l 60 x h 35 p 150 x l 60 x h 35 p 191 x l 63 x h 38

Boîtier d'encastrement Pag. 610/611

Orma_IJ | Up-Light | powerLED

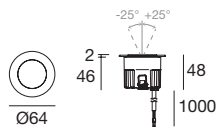

C.C. 4W DC - 350mA	Cct	Im S - D	Optic
Steel Alu 81199	M 2700	490 - 270	15 Spot (22°)
Brass Alu 82521	W 3000	490 - 270	30 Flood (29°)
	N 4000	529 - 292	60 W.Flood (48°)

Électronique

89421	99183	83100
ON/OFF 1 art. p 65 x l 74 x h 27	ON/OFF 1 - 2 art. p 80 x l 100 x h 31	DALI 1 - 4 art. p 54 x l 121 x h 26

C.V. 5W DC - 24 V DC	Cct	Im S - D	Optic
Steel Alu 81200	M 2700	490 - 270	15 Spot (22°)
Brass Alu 82522	W 3000	490 - 270	30 Flood (29°)
	N 4000	529 - 292	60 W.Flood (48°)

Électronique

89488	89179	89359	99332	99722
ON/OFF 1 - 2 art. p 80 x l 100 x h 31	ON/OFF 1 - 4 art. p 92 x l 117 x h 38	ON/OFF 1 - 9 art. p 115 x l 140 x h 50	0/1-10V 1 - 29 art. p 150 x l 60 x h 35	DALI 1 - 23 art. p 191 x l 63 x h 38

Boîtier d'encastrement Pag. 610/611

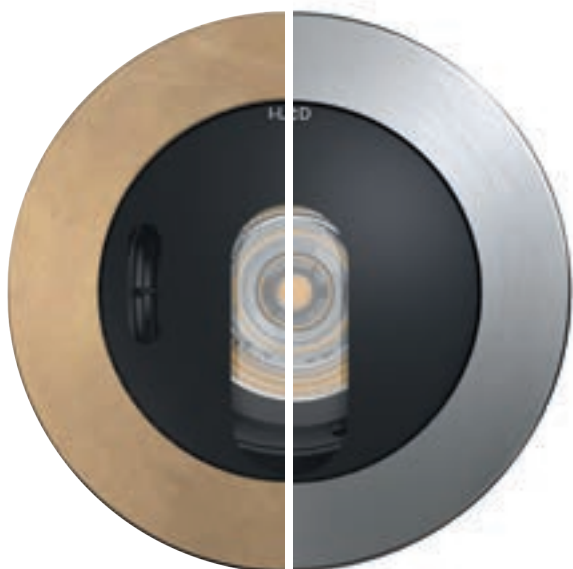

Orma_IJ Brass

Orma_IJ Steel

Orma_IJ | Up-Light | arrayLED

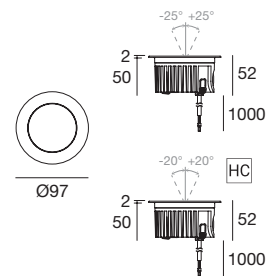

C.C. - 8W DC - 220mA	Cct	Im S - D	Optic
Steel Alu 81201	M 2700	1088 - 858	15 Spot (15°)
Brass Alu 82523	W 3000	1088 - 894	30 Flood (31°)
	N 4000	1173 - 944	60 W.Flood (61°)

C.C. - 8W DC - 220mA HC	Cct	Im S - D	Optic
Steel Alu 82456	M 2700	1088 - 619	15 Spot -
Brass Alu 82934	W 3000	1088 - 645	30 Flood -
	N 4000	1173 - 681	60 W.Flood -

Électronique

99342	83154
ON/OFF 1 art. p 80 x l 100 x h 31	DALI 1 art. p 54 x l 121 x h 26

C.V. 9W DC - 24 V DC	Cct	Im S - D	Optic
Steel Alu 81202	M 2700	1209 - 954	15 Spot (15°)
Brass Alu 82524	W 3000	1209 - 996	30 Flood (31°)
	N 4000	1303 - 1052	60 W.Flood (61°)

C.V. 9W DC - 24 V DC HC	Cct	Im S - D	Optic
Steel Alu 82457	M 2700	1209 - 687	15 Spot -
Brass Alu 82935	W 3000	1209 - 716	30 Flood -
	N 4000	1303 - 756	60 W.Flood -

Électronique

89179	89359	99331	99332	99722
ON/OFF 1 - 2 art. p 92 x l 117 x h 38	ON/OFF 1 - 5 art. p 115 x l 140 x h 50	ON/OFF 1 - 15 art. p 150 x l 60 x h 35	0/1-10V 1 - 15 art. p 150 x l 60 x h 35	DALI 1 - 12 art. p 191 x l 63 x h 38

Boîtier d'encastrement Pag. 610/611

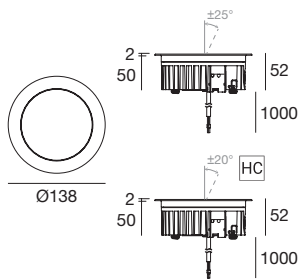

C.C. - 12W DC - 350mA		Cct	Im S - D	Optic
Steel/Alu	81203	M 2700	1724 - 1317	15 Spot (22°)
Brass/Alu	82525	W 3000	1724 - 1317	30 Flood (34°)
		N 4000	1854 - 1417	60 W.Flood (61°)

C.C. - 12W DC - 350mA ^{HC}		Cct	Im S - D	Optic
Steel/Alu	82458	M 2700	1724 - 935	15 Spot -
		W 3000	1724 - 935	30 Flood -
		N 4000	1854 - 1005	60 W.Flood -

Électronique

99183	83100
ON/OFF 1 art. p 80 x l 100 x h 31	DALI 1 art. p 54 x l 121 x h 26

C.V. 13W DC - 24 V DC		Cct	Im S - D	Optic
Steel/Alu	81204	M 2700	1724 - 1317	15 Spot (22°)
Brass/Alu	82526	W 3000	1724 - 1317	30 Flood (34°)
		N 4000	1854 - 1417	60 W.Flood (61°)

C.V. 13W DC - 24 V DC ^{HC}		Cct	Im S - D	Optic
Steel/Alu	82459	M 2700	1724 - 935	15 Spot -
		W 3000	1724 - 935	30 Flood -
		N 4000	1854 - 1005	60 W.Flood -

Électronique

89179	89359	99331	99332	99722
ON/OFF 1 art. p 92 x l 117 x h 38	ON/OFF 1 - 3 art. p 115 x l 140 x h 50	ON/OFF 1 - 10 art. p 150 x l 60 x h 35	0/1-10V 1 - 10 art. p 150 x l 60 x h 35	DALI 1 - 8 art. p 191 x l 63 x h 38

Boîtier d'encastrement Pag. 610/611

Orma_IL | Path-Marker | powerLED

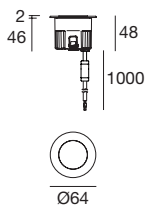

C.C. 1W DC - 350mA	Cct	lm S - D	Optic
Steel/Alu 81211	M 2700	136 - 16	00 General (117°)
	W 3000	145 - 18	
	N 4000	155 - 19	

Électronique

89419	89421	99183	83100
ON/OFF 1 - 2 art. p 65 x l 174 x h 27	ON/OFF 3 - 6 art. p 65 x l 174 x h 27	ON/OFF 6 - 12 art. p 80 x l 1100 x h 31	DALI 1 - 14 art. p 54 x l 121 x h 26

C.V. 1,5W DC - 24 V DC	Cct	lm S - D	Optic
Steel/Alu 81212	M 2700	136 - 16	00 General (117°)
	W 3000	145 - 18	
	N 4000	155 - 19	

Électronique

89488	89179	89359	99332	99722
ON/OFF 1 - 9 art. p 80 x l 100 x h 31	ON/OFF 1 - 15 art. p 92 x l 117 x h 38	ON/OFF 1 - 30 art. p 115 x l 140 x h 50	0/1-10V 1 - 98 art. p 150 x l 160 x h 35	DALI 1 - 78 art. p 191 x l 163 x h 38

Boîtier d'encastrement Pag. 610/611

Orma_IL | Path-Marker | powerLED

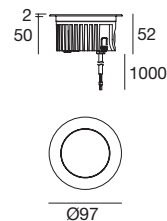
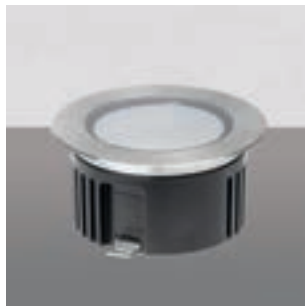

C.C. 2W DC - 630mA	Cct	lm S - D	Optic
Steel/Alu 81213	M 2700	249 - 24	00 General (118°)
	W 3000	266 - 26	
	N 4000	284 - 28	

Électronique

89420	99179	99186	83102
ON/OFF 1 - 2 art. p 65 x l 174 x h 27	ON/OFF 3 - 6 art. p 80 x l 100 x h 31	ON/OFF 6 - 12 art. p 92 x l 117 x h 38	DALI 1 - 14 art. p 54 x l 121 x h 26

C.V. 2,5W DC - 24 V DC	Cct	lm S - D	Optic
Steel/Alu 81214	M 2700	249 - 24	00 General (118°)
	W 3000	266 - 26	
	N 4000	284 - 28	

Électronique

89488	89179	89359	99332	99722
ON/OFF 1 - 5 art. p 80 x l 100 x h 31	ON/OFF 1 - 9 art. p 92 x l 117 x h 38	ON/OFF 1 - 18 art. p 115 x l 140 x h 50	0/1-10V 1 - 56 art. p 150 x l 160 x h 35	DALI 1 - 45 art. p 191 x l 163 x h 38

Boîtier d'encastrement Pag. 610/611

Orma_IL | Path-Marker | powerLED

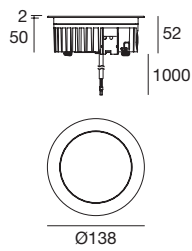

C.C. 4W DC - 350mA	Cct	Im S - D	Optic
Steel/Alu 81215	M 2700	490 - 89	00 General (116°)
	W 3000	490 - 89	
	N 4000	529 - 96	

Électronique

89421	99183	83100
ON/OFF 1 art. p 65 x l 74 x h 27	ON/OFF 1 - 2 art. p 80 x l 100 x h 31	DALI 1 - 4 art. p 54 x l 121 x h 26

C.V. 5W DC - 24 V DC	Cct	Im S - D	Optic
Steel/Alu 81216	M 2700	490 - 89	00 General (116°)
	W 3000	490 - 89	
	N 4000	529 - 96	

Électronique

89488	89179	89359	99332	99722
ON/OFF 1 - 2 art. p 80 x l 100 x h 31	ON/OFF 1 - 4 art. p 92 x l 117 x h 38	ON/OFF 1 - 9 art. p 115 x l 140 x h 50	0/1-10V 1 - 29 art. p 150 x l 60 x h 35	DALI 1 - 23 art. p 191 x l 63 x h 38

Boîtier d'encastrement Pag. 610/611

Boîtier d'encastrement

Orma A / AJ / AL / I / IJ / IL

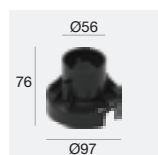

description	type
99650 Boîtiers d'encastrement	PVC
suitable for: Orma_A 4W - 5W / Orma_AJ 4W - 5W Orma_AL 1W - 1,5W / Orma_I 4W - 5W Orma_IJ 4W - 5W / Orma_IL 1W - 1,5W	



description	type
99651 Boîtiers d'encastrement	PVC
suitable for: Orma_A 8W - 9W / Orma_AJ 8W - 9W Orma_AL 2W - 2,5W / Orma_I 8W - 9W / Orma_IJ 8W - 9W Orma_IL 2W - 2,5W	



description	type
99652 Boîtiers d'encastrement	PVC
suitable for: Orma_A 12W - 13W / Orma_AJ 12W - 13W Orma_AL 4W - 4,5W / Orma_I 12W - 13W Orma_IJ 12W - 13W / Orma_IL 4W - 5W	

Orma A / AJ / AL

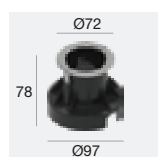

description	type
99560 Boîtiers d'encastrement	PVC
suitable for: Orma_A 4W - 5W / Orma_AJ 4W - 5W Orma_AL 1W - 1,5W	



description	type
99563 Boîtiers d'encastrement	PVC
suitable for: Orma_A 8W - 9W / Orma_AJ 8W - 9W Orma_AL 2W - 2,5W	



description	type
99564 Boîtiers d'encastrement	PVC
suitable for: Orma_A 12W - 13W / Orma_AJ 12W - 13W Orma_AL 4W - 4,5W	



description	type
99855 Boîtiers d'encastrement	PVC
suitable for: Orma_A 4W - 5W / Orma_AJ 4W - 5W Orma_AL 1W - 1,5W	



description	type
99856 Boîtiers d'encastrement	PVC
suitable for: Orma_A 8W - 9W / Orma_AJ 8W - 9W Orma_AL 2W - 2,5W	



description	type
99857 Boîtiers d'encastrement	PVC
suitable for: Orma_A 12W - 13W / Orma_AJ 12W - 13W Orma_AL 4W - 4,5W	

Orma F / FJ / FL / FO

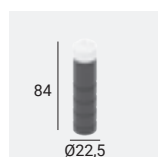

description	type
99925 Boîtiers d'encastrement	PVC
suitable for: Orma_F 1W / Orma_FL 1,5W	

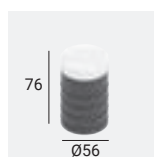

description	type
99922 Boîtiers d'encastrement	PVC
suitable for: Orma_F 4W - 5W / Orma_FJ 4W - 5W Orma_FL 1W - 1,5W / Orma_FO 1W - 1,5W	



description	type
99923 Boîtiers d'encastrement	PVC
suitable for: Orma_F 8W - 9W / Orma_FJ 8W - 9W Orma_FL 2W - 2,5W - Orma_FO 2W - 2,5W	



description	type
99924 Boîtiers d'encastrement	PVC
suitable for: Orma_F 12W - 13W / Orma_FJ 12W - 13W Orma_FL 4W - 5W / Orma_FO 4W - 5W	



description	type
98292 Boîtier d'encastrement	PVC
suitable for: Orma_FO 1,5W	



description	type
98291 Boîtier d'encastrement	
suitable for: Orma_FO 1,5W	

Orma F / FJ / FL / FO

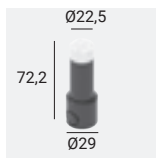

description	type
83036 Boîtiers d'encastrement PVC	
suitable for: Orma_F 1W / Orma_FL 1W	

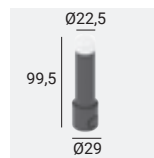

description	type
83037 Boîtiers d'encastrement PVC	
suitable for: Orma_F 1,5W / Orma_FL 1,5W	

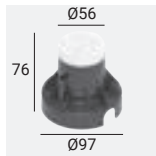

description	type
83038 Boîtiers d'encastrement PVC	
suitable for: Orma_F 4W - 5W / Orma_FJ 4W - 5W Orma_FL 1W - 1,5W / Orma_FO 1W - 1,5W	



description	type
83039 Boîtiers d'encastrement PVC	
suitable for: Orma_F 8W - 9W / Orma_FJ 8W - 9W Orma_F 2W - 2,5W - Orma_FO 2W - 2,5W	



description	type
83040 Boîtiers d'encastrement PVC	
suitable for: Orma_F 12W - 13W / Orma_FJ 12W - 13W Orma_FL 4W - 5W / Orma_FO 4W - 5W	

INSTALLATION

Installation simple en trois étapes (**Boîtier d'encastrement 99563 + Orma AJ 81207W15**)

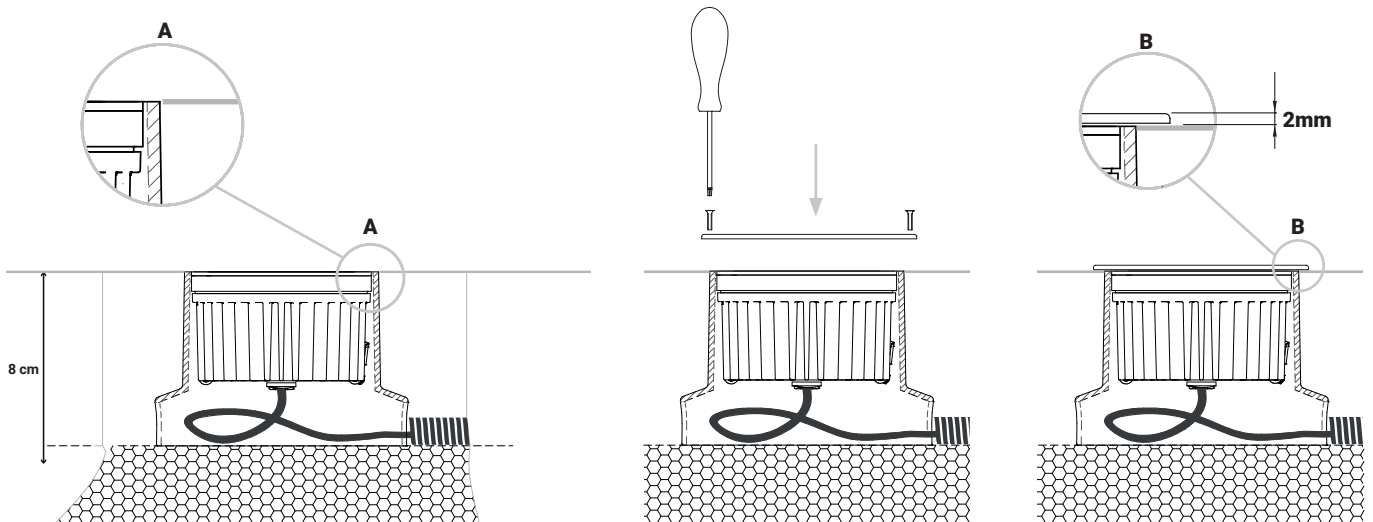

SYSTÈME DE VERROUILLAGE

Boîtiers encastrables garantissant une grande précision d'orientation (versions orientables) de l'appareil, grâce aux rainures spéciales qui stabilisent les ressorts et bloquent la rotation sur le long terme.

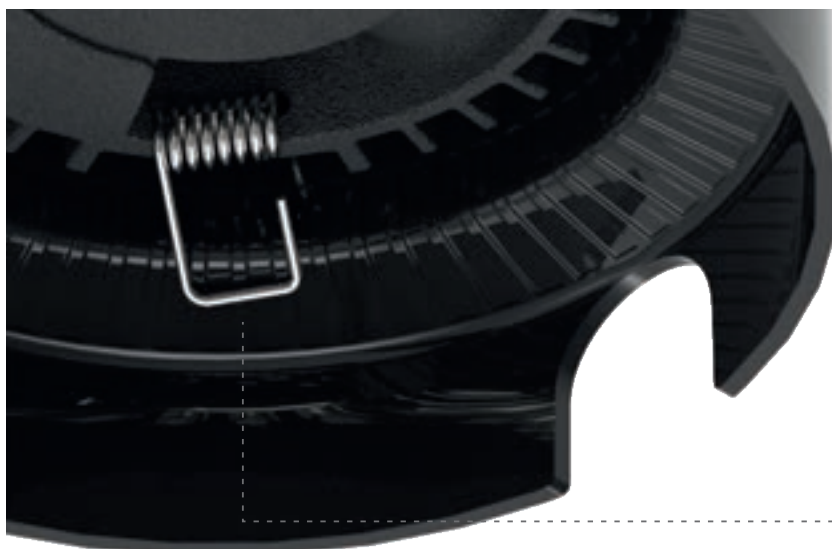

Alignement précis avec la version orientable (Orma_J)

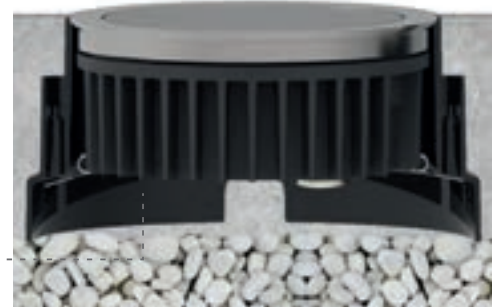

beret

Matériaux

Corps en laiton ou en aluminium

Bride en laiton ou en acier

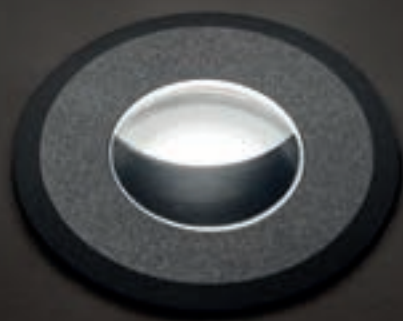



Beret_R | Walk-over spotlight | powerLED 1W DC 350 mA



29



		Cct	Im S - D	Optic
White	92065	M 2700	136 - 82	15 Spot (21°)
Grey	92061	W 3000	145 - 92	30 Flood (26°)
Chrome	92066	N 4000	155 - 99	60 W.Flood (56°)
Nickel	92067			00 General (104°)
Steel	92068			
Brass	81469			

Électronique

89419	89421	99183	83100
ON/OFF 1 - 2 art. p 65 x 174 x h 27	ON/OFF 3 - 6 art. p 65 x 174 x h 27	ON/OFF 6 - 12 art. p 80 x 1100 x h 31	DALI 1 - 14 art. p 54 x 1121 x h 26

Boîtier d'encastrement Pag. 615

RTG 92065W15 / 92065W30 / 92065W00 / 92066W30 / 92067W00
92067W15 / 92067W30 / 92067W60 / 92068W15 / 92068W30
92068W60 / 92068W00 / 92068N30 / 92068N00

Beret_2R | Walk-over spotlight | powerLED 2W DC 630 mA

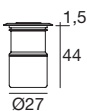
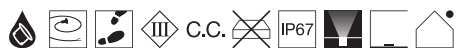

		Cct	Im S - D	Optic
Chrome	93126	M 2700	219 - 131	08 N.Spot (10°)
Nickel	93127	W 3000	233 - 148	15 Spot (21°)
Steel	93128	N 4000	249 - 159	30 Flood (26°)
Brass	81470			60 W.Flood (56°)
				12 E.W.Flood(89°)
				00 General (104°)

Électronique

89420	99179	99186	83102
ON/OFF 1 - 2 art. p 65 x 174 x h 27	ON/OFF 3 - 6 art. p 80 x 1100 x h 31	ON/OFF 6 - 12 art. p 92 x 1117 x h 38	DALI 1 - 14 art. p 54 x 1121 x h 26

Boîtier d'encastrement Pag. 615

RTG 93126W08 / 93126W30 / 93127W00 / 93127W08 / 93127W15
93127W30 / 93127W60 / 93127N30 / 93128W08 / 93128W15
93128W30 / 93128W60 / 93128W00 / 93128N30

614

Beret_X Anti-glaring | Walk-over spotlight | powerLED 1W DC 350 mA



29



		Cct	Im S - D	Optic
White	97800	M 2700	136 - 32	15 N.Spot (22°)
Grey	97801	W 3000	145 - 34	30 Spot (26°)
Chrome	97797	N 4000	155 - 36	60 Flood (54°)
Nickel	97798			
Steel	97799			
Brass	81471			

Électronique

89419	89421	99183	83100
ON/OFF 1 - 2 art. p 65 x 174 x h 27	ON/OFF 3 - 6 art. p 65 x 174 x h 27	ON/OFF 6 - 12 art. p 80 x 1100 x h 31	DALI 1 - 14 art. p 54 x 1121 x h 26

Boîtier d'encastrement Pag. 615

RTG 97800W30 / 97799W30 / 97799W60



Beret_X Anti-glaring



Beret_Q | Walk-over spotlight | powerLED 1W DC 350 mA

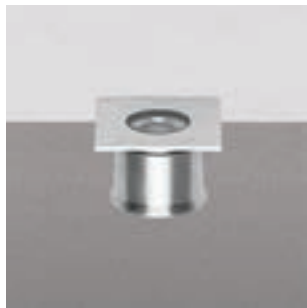
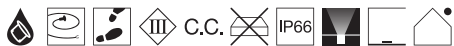

29



		Cct	Im S - D	Optic
White	92088	M 2700	136 - On Req	15 Spot (21°)
Grey	92092	W 3000	145 - 112	30 Flood (26°)
Chrome	92069	N 4000	155 - 120	60 W.Flood (56°)
Nickel	92076			00 General (104°)
Steel	92077			

Électronique

89419	89421	99183	83100
ON/OFF 1 - 2 art. p 65 x l 74 x h 27	ON/OFF 3 - 6 art. p 65 x l 74 x h 27	ON/OFF 6 - 12 art. p 80 x l 100 x h 31	DALI 1 - 14 art. p 54 x l 121 x h 26

Boîtier d'encastrement Pag. 615

RTG 92077W00

Beret_2Q | Walk-over spotlight | powerLED 2W DC 630 mA

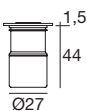
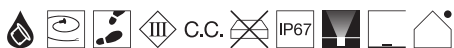

		Cct	Im S - D	Optic
Chrome	93138	M 2700	219 - 131	08 N.Spot (10°)
Nickel	93139	W 3000	233 - 148	15 Spot (21°)
Steel	93140	N 4000	249 - 159	30 Flood (25°)
				60 W.Flood (56°)
				12 E.W.Flood (89°)
				00 General (104°)

Électronique

89420	99179	99186	83102
ON/OFF 1 - 2 art. p 65 x l 74 x h 27	ON/OFF 3 - 6 art. p 80 x l 100 x h 31	ON/OFF 6 - 12 art. p 92 x l 117 x h 38	DALI 1 - 14 art. p 54 x l 121 x h 26

Boîtier d'encastrement Pag. 615

RTG 93140W30

Beret_2Q | Walk-over spotlight | powerLED 2W DC 630 mA



29

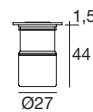

		Cct	Im S - D	Optic
Chrome	93132	M 2700	219 - 131	08 N.Spot (10°)
Nickel	93133	W 3000	233 - 148	15 Spot (21°)
Steel	93134	N 4000	249 - 159	30 Flood (26°)
				60 W.Flood (56°)
				12 E.W.Flood (89°)
				00 General (104°)

Électronique

89420	99179	99186	83102
ON/OFF 1 - 2 art. p 65 x l 74 x h 27	ON/OFF 3 - 6 art. p 80 x l 100 x h 31	ON/OFF 6 - 12 art. p 92 x l 117 x h 38	DALI 1 - 14 art. p 54 x l 121 x h 26

Boîtier d'encastrement Pag. 615

RTG 93134W30

Boîtier d'encastrement

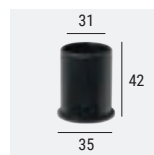

description	type
84336 Boîtiers d'encastrement	PVC

suitable for: Beret_R / Beret_X / Beret_Q



description	type
84915 Boîtiers d'encastrement	PVC

suitable for: Beret_R / Beret_X / Beret_Q



description	type
84918 Boîtiers d'encastrement	PVC

suitable for: Beret_2R / Beret_2Q

zalex

Matériaux

Corps en inox AISI 316L

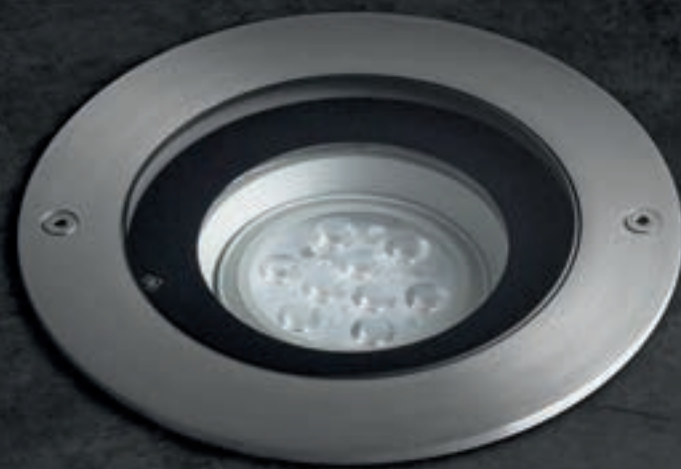

Zalex | Drive-over spotlight | powerLED 6W DC 630 mA

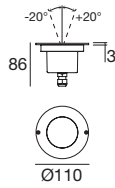
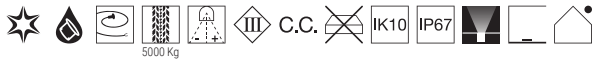

	Cct	lm S - D	Optic
Steel 94137	M 2700	657 - On req	15 Spot (22°)
	W 3000	699 - 581	30 Flood (29°)
	N 4000	747 - 620	60 W.Flood (52°)

Électronique

99179	99186	83102
ON/OFF 1 - 2 art. p 80 x l 100 x h 31	ON/OFF 2 - 4 art. p 92 x l 117 x h 38	DALI 1 - 4 art. p 54 x l 121 x h 26

Boîtier d'encastrement Pag. 617

Zalex | Drive-over spotlight | powerLED 18W DC 630 mA

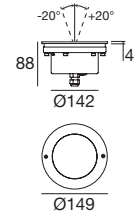
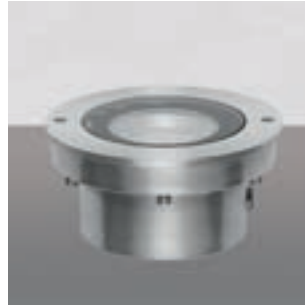
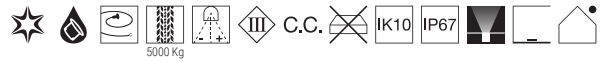

	Cct	lm S - D	Optic
Steel 94138	M 2700	1971 - On req	15 Spot (22°)
	W 3000	2097 - 1743	30 Flood (29°)
	N 4000	2241 - 1860	60 W.Flood (52°)

Électronique

99186	83102
ON/OFF 1 art. p 92 x l 117 x h 38	DALI 1 art. p 54 x l 121 x h 26

Boîtier d'encastrement Pag. 617

Private Villa | Athens, Greece



Boîtier d'encastrement



description

98134	Boîtier d'encastrement	PVC
suitable for: Zalex 6W		



description

98133	Boîtier d'encastrement	PVC
suitable for: Zalex 18W		

Uplight

fasim

Matériaux

Corps en aluminium anodisé

Bride en inox AISI 316



Fasim | Walk-over spotlight | 198-264V AC | arrayLED 8W DC - 10W AC

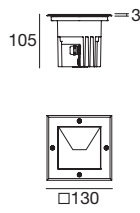
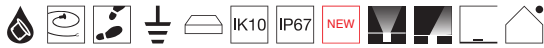

	Cct	lm S - D	Optic
Steel/Alu 82222	M 2700	1072 - On req	15 Spot -
	W 3000	1117 - On req	30 Flood -
	N 4000	1180 - On req	60 W.Flood -
Steel/Alu 82223	M 2700	1239 - On req	07 Asymm -
	W 3000	1291 - On req	
	N 4000	1363 - On req	
Steel/Alu 82224	M 2700	760 - On req	06 N.Spot -
	W 3000	760 - On req	
	N 4000	821 - On req	

Code 82224 powerLED

Boîtier d'encastrement Pag. 621

Fasim_J | Walk-over spotlight | 198-264V AC | powerLED 7,2W DC - 8W AC

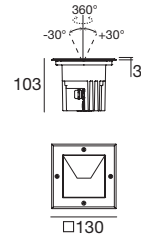
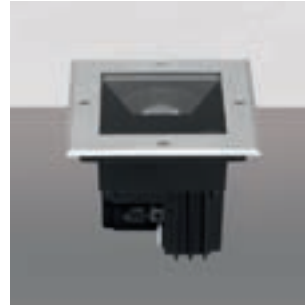

	Cct	lm S - D	Optic
Steel/Alu 82464	M 2700	760 - On req	15 N.Spot -
	W 3000	760 - On req	30 Spot -
	N 4000	821 - On req	60 Flood -

Boîtier d'encastrement Pag. 621

Fasim | Walk-over spotlight | 198-264V AC | arrayLED 13W DC - 14,5W AC

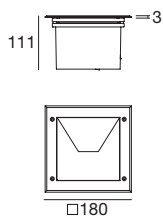
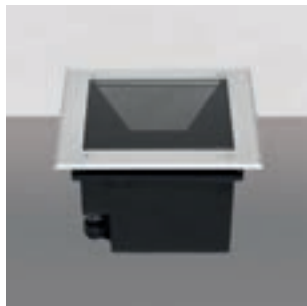

	Cct	lm S - D	Optic
Steel/Alu 81943	M 2700	1724 - On req	15 Spot -
	W 3000	1724 - On req	30 Flood -
	N 4000	1854 - On req	60 W.Flood -

Boîtier d'encastrement Pag. 621

Fasim | Walk-over spotlight | 198-264V AC | arrayLED 13W DC - 14,5W AC

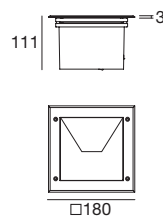
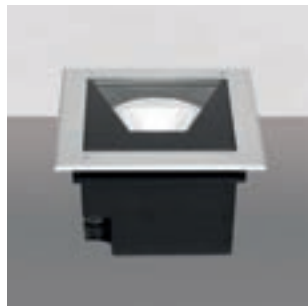

	Cct	lm S - D	Optic
Steel/Alu 94415	M 2700	1743 - 1553	07 Asymm. -
	W 3000	1863 - 1660	
	N 4000	1863 - 1786	

Boîtier d'encastrement Pag. 621

Fasim | Walk-over spotlight | 198-264 V AC | powerLEDs 13 W DC - 14,5 W AC

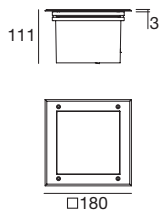

	Cct	lm S - D	Optic
Steel/Alu 94659	M 2700	1683 - 1503	03 N.Spot (9°)
	W 3000	1791 - 1602	
	N 4000	1917 - 1710	

Boîtier d'encastrement Pag. 621

Fasim_J | Walk-over spotlight | 198-264 V AC | arrayLED 13 W DC - 14,5 W AC

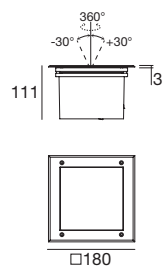

	Cct	lm S - D	Optic
Steel/Alu 81944	M 2700	1724 - On req	15 Spot -
	W 3000	1724 - On req	30 Flood -
	N 4000	1854 - On req	60 W.Flood -

Boîtier d'encastrement Pag. 621

Boîtier d'encastrement

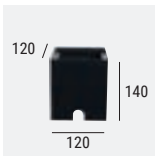

description

84928 Boîtier d'encastrement **PVC**
suitable for: Fasim 8W / Fasim_J 7,2W

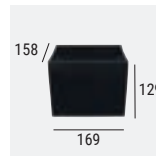

description

84906 Boîtier d'encastrement **PVC**
suitable for: Fasim 13W / Fasim_J 13W

Marionette Theatre | Düsseldorf, Germany



concentrica

Matériaux

Corps en aluminium

Diffuseur simple ou double en polycarbonate opalin

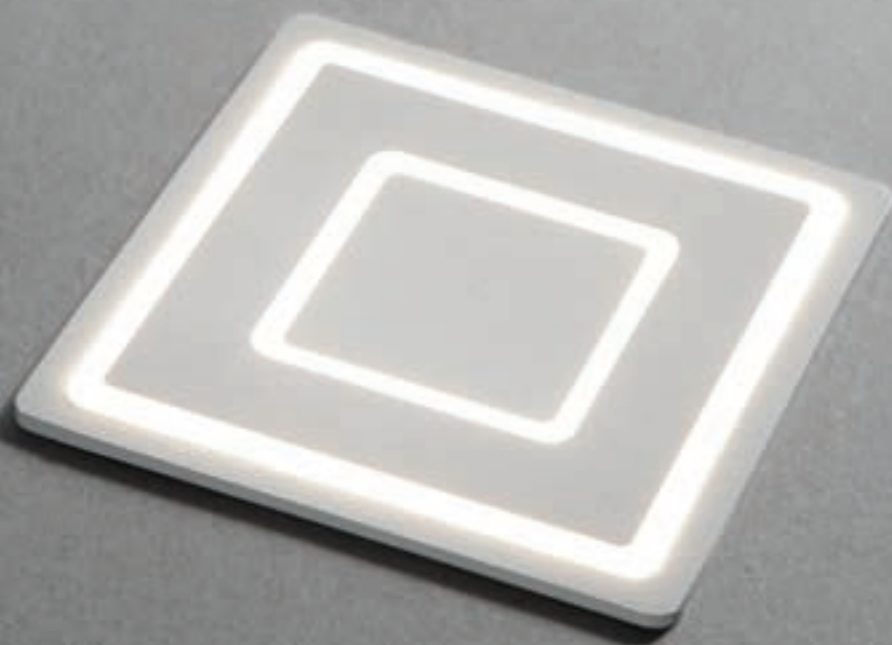

Concentrica_Q | Drive-over spotlights | 24 V DC | topLED 1.4 W DC

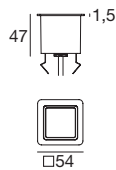

		Cct	lm S - D	Optic
White	96659	M 2700	54 - On req.	00 General (180°)
Black	96660	W 3000	60 - On req.	
Grey	96661	N 4000	63 - On req.	

Électronique

89488	89179	89359	99332	99722
ON/OFF 1 - 9 art. p 80 x l 100 x h 31	ON/OFF 1 - 15 art. p 92 x l 117 x h 38	ON/OFF 1 - 30 art. p 115 x l 140 x h 50	0/1-10V 1 - 98 art. p 150 x l 160 x h 35	DALI 1 - 78 art. p 191 x l 163 x h 38

Boîtier d'encastrement Pag. 623

Concentrica_Q | Drive-over spotlights | 24 V DC | topLED 2.6 W DC

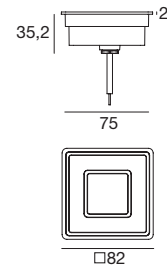
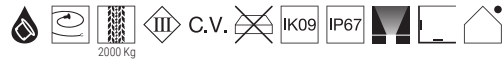

		Cct	lm S - D	Optic
White	94059	M 2700	216 - On req.	00 General (142°)
Black	94060	W 3000	240 - On req.	
Grey	94061	N 4000	252 - On req.	

Électronique

89488	89179	89359	99332	99722
ON/OFF 1 - 5 art. p 80 x l 100 x h 31	ON/OFF 1 - 9 art. p 92 x l 117 x h 38	ON/OFF 1 - 18 art. p 115 x l 140 x h 50	0/1-10V 1 - 56 art. p 150 x l 160 x h 35	DALI 1 - 45 art. p 191 x l 163 x h 38

Boîtier d'encastrement Pag. 623

Boîtier d'encastrement

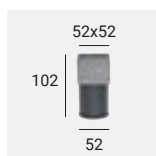

description	
98402	Boîtier d'encastrement
suitable for: Concentrica_Q 1,4W	

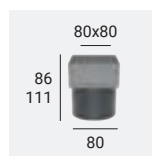

description	
98877	Boîtier d'encastrement
suitable for: Concentrica_Q 2,6W	

alcor

Matériaux

Corps en inox AISI 316L

Corps en laiton

Diffuseur en verre trempé prismatique





Alcor_R1 | Drive-over spotlights | powerLED

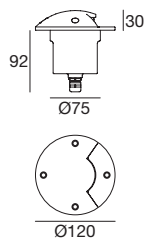

6.4 W DC 500 mA		Cct	lm S - D	Optic
Steel	87603	W 3000	566 - 432	18 General (180°)
		N 4000	626 - 500	

Électronique

99181	99185	83101
ON/OFF 1 art. p 80 x l 100 x h 31	ON/OFF 2 - 3 art. p 92 x l 117 x h 38	DALI 1 - 4 art. p 54 x l 121 x h 26



4.2 W DC 5 W AC		Cct	lm S - D	Optic
Steel	87600	W 3000	432 - 320	18 General (180°)
		N 4000	477 - 370	

Boîtier d'encastrement Pag. 629

RTG 87600W18

Alcor_R4 | Drive-over spotlights | powerLED

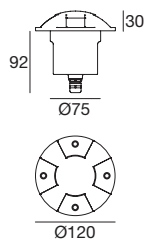

6.4 W DC 500 mA		Cct	lm S - D	Optic
Steel	87605	W 3000	566 - 432	18 General (180°)
		N 4000	626 - 500	

Électronique

99181	99185	83101
ON/OFF 1 art. p 80 x l 100 x h 31	ON/OFF 2 - 3 art. p 92 x l 117 x h 38	DALI 1 - 4 art. p 54 x l 121 x h 26



4.2 W DC 5 W AC		Cct	lm S - D	Optic
Steel	87602	W 3000	432 - 320	18 General (180°)
		N 4000	477 - 370	

Boîtier d'encastrement Pag. 629

Alcor_R2 | Drive-over spotlights | powerLED

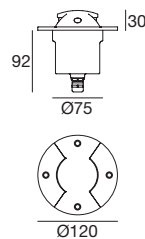

6.4 W DC 500 mA		Cct	lm S - D	Optic
Steel	87604	W 3000	566 - 432	18 General (180°)
		N 4000	626 - 500	

Électronique

99181	99185	83101
ON/OFF 1 art. p 80 x l 100 x h 31	ON/OFF 2 - 3 art. p 92 x l 117 x h 38	DALI 1 - 4 art. p 54 x l 121 x h 26

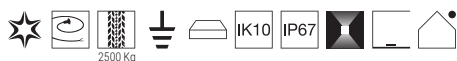

4.2 W DC 5 W AC		Cct	lm S - D	Optic
Steel	87601	W 3000	432 - 320	18 General (180°)
		N 4000	477 - 370	

Boîtier d'encastrement Pag. 629

Alcor_R | Drive-over spotlights | powerLED 1,5 W DC 500 mA

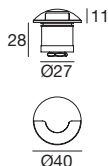

		Cct	lm S - D	Optic
Steel	97353	W 3000	199 - 143	18 General (180°)
Brass	83606	N 4000	213 - 152	

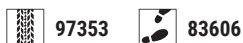

Électronique

89422	89423	99181	99185	83101
ON/OFF 1 - 2 art. p 65 x l 74 x h 27	ON/OFF 2 - 3 art. p 65 x l 74 x h 27	ON/OFF 3 - 6 art. p 80 x l 100 x h 31	ON/OFF 6 - 12 art. p 92 x l 117 x h 38	DALI 1 - 12 art. p 54 x l 121 x h 26

Boîtier d'encastrement Pag. 629

RTG 97353W18 / 97353N18

Alcor_R2 | Drive-over spotlights | powerLED 1,5 W DC 500 mA

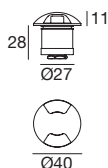

		Cct	lm S - D	Optic
Steel	97355	W 3000	199 - 143	18 General (180°)
Brass	83608	N 4000	213 - 152	



Électronique

89422	89423	99181	99185	83101
ON/OFF 1 - 2 art. p 65 x l 74 x h 27	ON/OFF 2 - 3 art. p 65 x l 74 x h 27	ON/OFF 3 - 6 art. p 80 x l 100 x h 31	ON/OFF 6 - 12 art. p 92 x l 117 x h 38	DALI 1 - 12 art. p 54 x l 121 x h 26

Boîtier d'encastrement Pag. 629

RTG 97355W18

Alcor_R1 | Drive-over spotlights | powerLED 1,5 W DC 500 mA

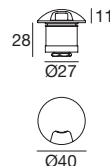

		Cct	lm S - D	Optic
Steel	97354	W 3000	199 - 143	18 General (180°)
Brass	83607	N 4000	213 - 152	



Électronique

89422	89423	99181	99185	83101
ON/OFF 1 - 2 art. p 65 x l 74 x h 27	ON/OFF 2 - 3 art. p 65 x l 74 x h 27	ON/OFF 3 - 6 art. p 80 x l 100 x h 31	ON/OFF 6 - 12 art. p 92 x l 117 x h 38	DALI 1 - 12 art. p 54 x l 121 x h 26

Boîtier d'encastrement Pag. 629

RTG 97354W18 / 97354N18

Alcor_R4 | Drive-over spotlights | powerLED 1,5 W DC 500 mA

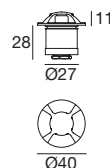

		Cct	lm S - D	Optic
Steel	97356	W 3000	199 - 143	18 General (180°)
Brass	83609	N 4000	213 - 152	



Électronique

89422	89423	99181	99185	83101
ON/OFF 1 - 2 art. p 65 x l 74 x h 27	ON/OFF 2 - 3 art. p 65 x l 74 x h 27	ON/OFF 3 - 6 art. p 80 x l 100 x h 31	ON/OFF 6 - 12 art. p 92 x l 117 x h 38	DALI 1 - 12 art. p 54 x l 121 x h 26

Boîtier d'encastrement Pag. 629

RTG 97356W18

Alcor_Q1 | Drive-over spotlights | powerLED 1,5 W DC 500 mA

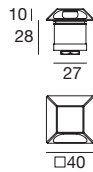

		Cct	lm S - D	Optic
Steel	81736	W 3000	199 - On req	18 General -
Brass	83610	N 4000	213 - On req	



Électronique

89422	89423	99181	99185	83101
ON/OFF 1 - 2 art. p 65 x l 74 x h 27	ON/OFF 2 - 3 art. p 65 x l 74 x h 27	ON/OFF 3 - 6 art. p 80 x l 100 x h 31	ON/OFF 6 - 12 art. p 92 x l 117 x h 38	DALI 1 - 12 art. p 54 x l 121 x h 26

Boîtier d'encastrement Pag. 629

Alcor_Q2 | Drive-over spotlights | powerLED 1,5 W DC 500 mA

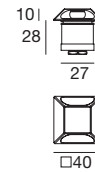
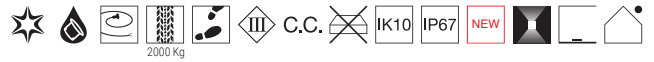

		Cct	lm S - D	Optic
Steel	81750	W 3000	199 - On req	18 General -
Brass	83611	N 4000	213 - On req	



Électronique

89422	89423	99181	99185	83101
ON/OFF 1 - 2 art. p 65 x l 74 x h 27	ON/OFF 2 - 3 art. p 65 x l 74 x h 27	ON/OFF 3 - 6 art. p 80 x l 100 x h 31	ON/OFF 6 - 12 art. p 92 x l 117 x h 38	DALI 1 - 12 art. p 54 x l 121 x h 26

Boîtier d'encastrement Pag. 629

Alcor_Q4 | Drive-over spotlights | powerLED 1,5 W DC 500 mA

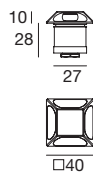

		Cct	lm S - D	Optic
Steel	81751	W 3000	199 - On req	18 General -
Brass	83612	N 4000	213 - On req	



Électronique

89422	89423	99181	99185	83101
ON/OFF 1 - 2 art. p 65 x l 74 x h 27	ON/OFF 2 - 3 art. p 65 x l 74 x h 27	ON/OFF 3 - 6 art. p 80 x l 100 x h 31	ON/OFF 6 - 12 art. p 92 x l 117 x h 38	DALI 1 - 12 art. p 54 x l 121 x h 26

Boîtier d'encastrement Pag. 629

Alcor_R1 Blade | Drive-over spotlights | 190-250V | powerLED 2 W DC 2,5 W AC

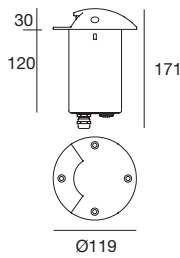

	Cct	lm S - D	Optic
Grey 83523	M 2700	219 - On req	05 N.Spot -
	W 3000	233 - On req	12 E.W.Flood -
	N 4000	249 - On req	

Boîtier d'encastrement Pag. 629

Alcor_R1 Blade | Drive-over spotlights | 190-250V | powerLED 4 W DC 4,5 W AC

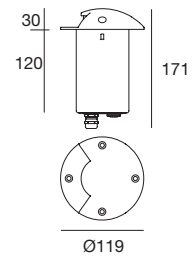
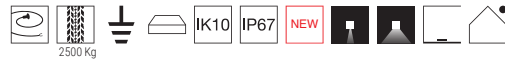

	Cct	lm S - D	Optic
Grey 82639	M 2700	490 - On req	05 N.Spot -
	W 3000	490 - On req	12 E.W.Flood -
	N 4000	529 - On req	

Boîtier d'encastrement Pag. 629

Alcor_R2 Blade | Drive-over spotlights | 190-250V | powerLED 4 W DC 4,5 W AC

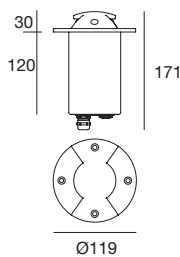

	Cct	lm S - D	Optic
Grey 83521	M 2700	438 - On req	05 N.Spot -
	W 3000	466 - On req	12 E.W.Flood -
	N 4000	498 - On req	

Boîtier d'encastrement Pag. 629

Alcor_R2 Blade | Drive-over spotlights | 190-250V | powerLED 8 W DC 9 W AC

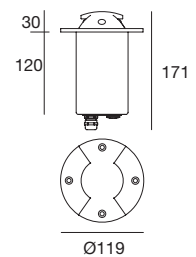
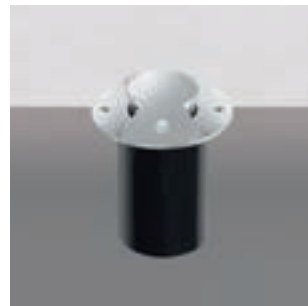
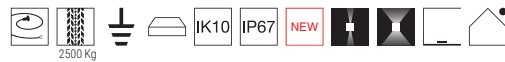

	Cct	lm S - D	Optic
Grey 82640	M 2700	980 - On req	05 N.Spot -
	W 3000	980 - On req	12 E.W.Flood-
	N 4000	1058 - On req	

Boîtier d'encastrement Pag. 629

Boîtier d'encastrement



description	
84341	Boîtier d'encastrement PVC
suitable for: Alcor_R1 4,2 - 6,4W / Alcor_R2 4,2 - 6,4W Alcor_R4 4,2 - 6,4W	



description	
84900	Boîtier d'encastrement PVC
suitable for: Alcor_R1 Blade 2W - 4W Alcor_R2 Blade 4W - 8W	



description	
84918	Boîtier d'encastrement PVC
suitable for: Alcor_R 1,5W / Alcor_R1 1,5W / Alcor_R2 1,5W Alcor_R4 1,5W / Alcor_Q1 / Alcor_Q2 / Alcor_Q4	

Alcor_AI_1 | Drive-over spotlights | powerLED 2 W DC 630 mA

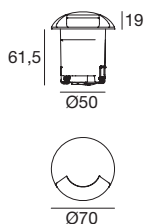

		Cct	lm S - D	Optic
Grey	86096	W 3000	219 - 208	18 General (180°)
		N 4000	233 - 222	

Électronique

89420	99179	99186	83102
ON/OFF 1 - 2 art. p 65 x l 74 x h 27	ON/OFF 3 - 6 art. p 80 x l 100 x h 31	ON/OFF 6 - 12 art. p 92 x l 117 x h 38	DALI 1 - 14 art. p 54 x l 121 x h 26

Boîtier d'encastrement Pag. 633

RTG 86096W18

Alcor_AI_4 | Drive-over spotlights | powerLED 2 W DC 630 mA

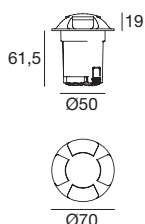

		Cct	lm S - D	Optic
Grey	86104	W 3000	219 - 208	18 General (180°)
		N 4000	233 - 222	

Électronique

89420	99179	99186	83102
ON/OFF 1 - 2 art. p 65 x l 74 x h 27	ON/OFF 3 - 6 art. p 80 x l 100 x h 31	ON/OFF 6 - 12 art. p 92 x l 117 x h 38	DALI 1 - 14 art. p 54 x l 121 x h 26

Boîtier d'encastrement Pag. 633

RTG 86104W18

Alcor_AI_2 | Drive-over spotlights | powerLED 2 W DC 630 mA

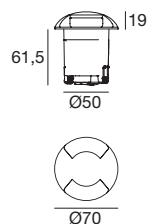

		Cct	lm S - D	Optic
Grey	86100	W 3000	219 - 208	18 General (180°)
		N 4000	233 - 222	

Électronique

89420	99179	99186	83102
ON/OFF 1 - 2 art. p 65 x l 74 x h 27	ON/OFF 3 - 6 art. p 80 x l 100 x h 31	ON/OFF 6 - 12 art. p 92 x l 117 x h 38	DALI 1 - 14 art. p 54 x l 121 x h 26

Boîtier d'encastrement Pag. 633

Alcor_AI_1 | Drive-over spotlights | 198-264 V AC | powerLED 2 W DC 2,5 W AC

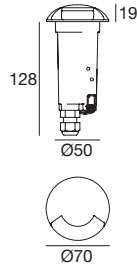
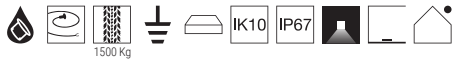

	Cct	lm S - D	Optic
Grey 86097	W 3000	219 - 208	18 General (180°)
	N 4000	233 - 222	

Boîtier d'encastrement Pag. 633

RTG 86097W18

Alcor_AI_2 | Drive-over spotlights | 198-264 V AC | powerLED 2 W DC 2,5 W AC

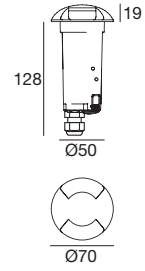

	Cct	lm S - D	Optic
Grey 86101	W 3000	219 - 208	18 General (180°)
	N 4000	233 - 222	

Boîtier d'encastrement Pag. 633

Alcor_AI_4 | Drive-over spotlights | 198-264 V AC | powerLED 2 W DC 2,5 W AC

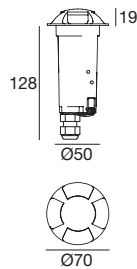

	Cct	lm S - D	Optic
Grey 86105	W 3000	219 - 208	18 General (180°)
	N 4000	233 - 222	

Boîtier d'encastrement Pag. 633

Alcor_AI_1 | Drive-over spotlights | arrayLED 6 W DC

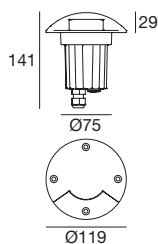

	Cct	lm S - D	Optic
Grey 91422	W 3000	685 - 680	18 General (180°)
	N 4000	739 - 680	

Électronique

99179	99186	83102
ON/OFF 1 - 2 art. p 80 x l 100 x h 31	ON/OFF 2 - 4 art. p 92 x l 117 x h 38	DALI 1 - 4 art. p 54 x l 121 x h 26

Boîtier d'encastrement Pag. 633

RTG 91422W18

Alcor_AI_4 | Drive-over spotlights | arrayLED 6 W DC

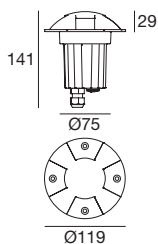

	Cct	lm S - D	Optic
Grey 91424	W 3000	685 - 680	18 General (180°)
	N 4000	739 - 680	

Électronique

99179	99186	83102
ON/OFF 1 - 2 art. p 80 x l 100 x h 31	ON/OFF 2 - 4 art. p 92 x l 117 x h 38	DALI 1 - 4 art. p 54 x l 121 x h 26

Boîtier d'encastrement Pag. 633

Alcor_AI_2 | Drive-over spotlights | arrayLED 6 W DC

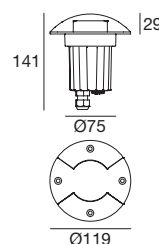

	Cct	lm S - D	Optic
Grey 91423	W 3000	685 - 680	18 General (180°)
	N 4000	739 - 680	

Électronique

99179	99186	83102
ON/OFF 1 - 2 art. p 80 x l 100 x h 31	ON/OFF 2 - 4 art. p 92 x l 117 x h 38	DALI 1 - 4 art. p 54 x l 121 x h 26

Boîtier d'encastrement Pag. 633

Alcor_AI_1 | Drive-over spotlights | 198-264 V AC | arrayLED 6 W DC 8 W AC

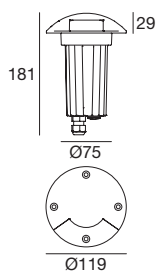

	Cct	lm S - D	Optic
Grey 91425	W 3000	685 - 680	18 General (180°)
	N 4000	739 - 680	

Boîtier d'encastrement Pag. 633

RTG 91425W18

Alcor_AI_2 | Drive-over spotlights | 198-264 V AC | arrayLED 6 W DC 8 W AC

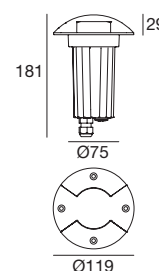
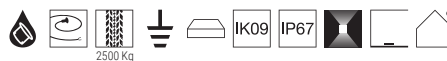

	Cct	lm S - D	Optic
Grey 91426	W 3000	685 - 680	18 General (180°)
	N 4000	739 - 680	

Boîtier d'encastrement Pag. 633

Alcor_AI_4 | Drive-over spotlights | 198-264 V AC | arrayLED 6 W DC 8 W AC

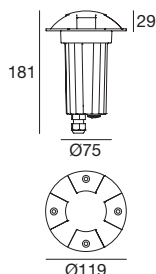

	Cct	lm S - D	Optic
Grey 91427	W 3000	685 - 680	18 General (180°)
	N 4000	739 - 680	

Boîtier d'encastrement Pag. 633

Boîtier d'encastrement



description	
84936	Boîtier d'encastrement PVC
suitable for: Alcor_AI_1 2W (86096)	
Alcor_AI_2 2W (86100) / Alcor_AI_4 2W (86104)	



description	
84935	Boîtier d'encastrement PVC
suitable for: Alcor_AI_1 2W (86097)	
Alcor_AI_2 2W (86101) / Alcor_AI_4 2W (86105)	



description	
98121	Boîtier d'encastrement PVC
suitable for: Alcor_AI_1 6W (91422)	
Alcor_AI_2 6W (91423) / Alcor_AI_4 6W (91424)	



description	
98122	Boîtier d'encastrement PVC
suitable for: Alcor_AI_1 6W (91425)	
Alcor_AI_2 6W (91426) / Alcor_AI_4 6W (91427)	

astropek

Matériaux

Corps en aluminium

Diffuseur en verre trempé prismatique

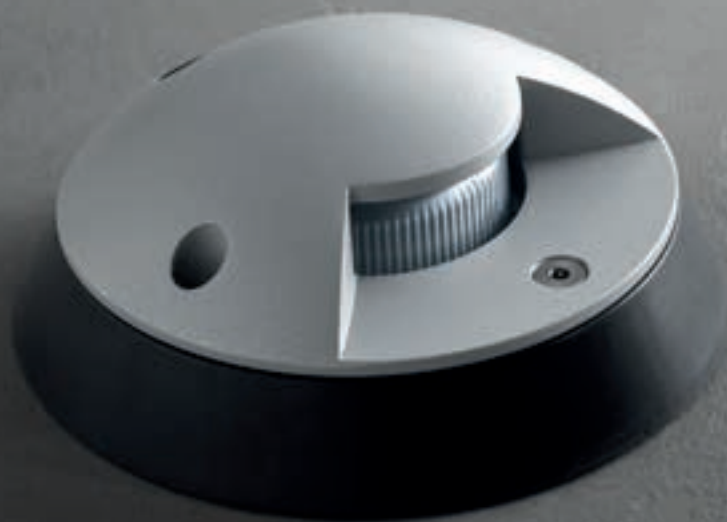



Astropek_1 | Drive-over spotlights | powerLED 2 W DC 630 mA

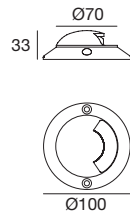

	Cct	lm S - D	Optic
Grey 86788	W 3000	233 - 208	18 General (180°)
	N 4000	249 - 222	

Électronique

89420	99179	99186	83102
ON/OFF 1 - 2 art. p 65 x l 74 x h 27	ON/OFF 3 - 6 art. p 80 x l 100 x h 31	ON/OFF 6 - 12 art. p 92 x l 117 x h 38	DALI 1 - 14 art. p 54 x l 121 x h 26

RTG 86788W18

Astropek_2 | Drive-over spotlights | powerLED 2 W DC 630 mA

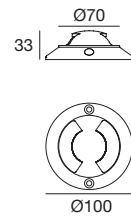

	Cct	lm S - D	Optic
Grey 86789	W 3000	233 - On req	18 General (180°)
	N 4000	249 - On req	

Électronique

89420	99179	99186	83102
ON/OFF 1 - 2 art. p 65 x l 74 x h 27	ON/OFF 3 - 6 art. p 80 x l 100 x h 31	ON/OFF 6 - 12 art. p 92 x l 117 x h 38	DALI 1 - 14 art. p 54 x l 121 x h 26

Astropek_4 | Drive-over spotlights | powerLED 2 W DC 630 mA

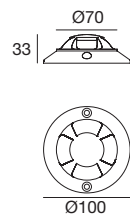

	Cct	lm S - D	Optic
Grey 86787	W 3000	233 - On req	18 General (180°)
	N 4000	249 - On req	

Électronique

89420	99179	99186	83102
ON/OFF 1 - 2 art. p 65 x l 74 x h 27	ON/OFF 3 - 6 art. p 80 x l 100 x h 31	ON/OFF 6 - 12 art. p 92 x l 117 x h 38	DALI 1 - 14 art. p 54 x l 121 x h 26

Astropek_1 Blade | Up-Light | powerLED 2 W DC 630mA

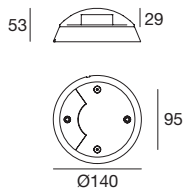
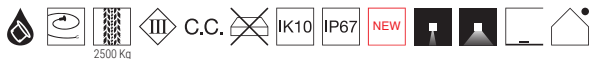

	Cct	lm S - D	Optic
Grey 83524	M 2700	219 - On req	05 N.Spot -
	W 3000	233 - On req	12 E.W.Flood-
	N 4000	249 - On req	

Électronique

89420	99179	99186	83102
ON/OFF 1 - 2 art. p 65 x l 74 x h 27	ON/OFF 3 - 6 art. p 80 x l 100 x h 31	ON/OFF 6 - 12 art. p 92 x l 117 x h 38	DALI 1 - 14 art. p 54 x l 121 x h 26

Astropek_1 Blade | Up-Light | powerLED 4 W DC 350mA

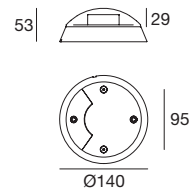

	Cct	lm S - D	Optic
Grey 82637	M 2700	490 - On req	05 N.Spot -
	W 3000	490 - On req	12 E.W.Flood-
	N 4000	529 - On req	

Électronique

89421	99183	83100
ON/OFF 1 art. p 65 x l 74 x h 27	ON/OFF 1 - 2 art. p 80 x l 100 x h 31	DALI 1 - 4 art. p 54 x l 121 x h 26

Astropek_2 Blade | Up-Light | 190-250 V | powerLED 4 W DC 630mA

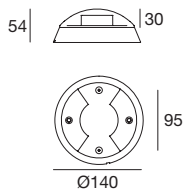

	Cct	lm S - D	Optic
Grey 83522	M 2700	438 - On req	05 N.Spot -
	W 3000	438 - On req	12 E.W.Flood-
	N 4000	498 - On req	

Électronique

89420	99179	99186	83102
ON/OFF 1 - 2 art. p 65 x l 74 x h 27	ON/OFF 3 - 6 art. p 80 x l 100 x h 31	ON/OFF 6 - 12 art. p 92 x l 117 x h 38	DALI 1 - 14 art. p 54 x l 121 x h 26

Astropek_2 Blade | Up-Light | 190-250 V | powerLED 8 W DC 350mA

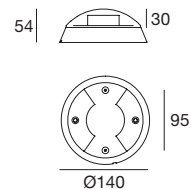

	Cct	lm S - D	Optic
Grey 82638	M 2700	980 - On req	05 N.Spot -
	W 3000	980 - On req	12 E.W.Flood-
	N 4000	1058 - On req	

Électronique

89421	99183	83100
ON/OFF 1 art. p 65 x l 74 x h 27	ON/OFF 1 - 2 art. p 80 x l 100 x h 31	DALI 1 - 4 art. p 54 x l 121 x h 26

footpad

Matériaux

Corps en inox AISI 316L

Diffuseur en polycarbonate



Footpad Flat | Drive-over spotlights | powerLED 4 W DC 350 mA

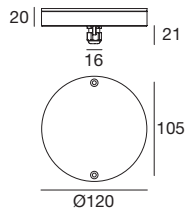
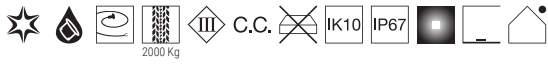

		Cct	lm S - D	Optic
Steel	96916	W 3000	428 - On req	00 General (180°)
		N 4000	456 - On req	

Électronique

89421	99183	83100
ON/OFF 1 art. p 65 x l 74 x h 27	ON/OFF 1 - 2 art. p 80 x l 100 x h 31	DALI 1 - 4 art. p 54 x l 121 x h 26

RTG 96916W00

Footpad Flat_Q | Drive-over spotlights | powerLED 4 W DC 350 mA

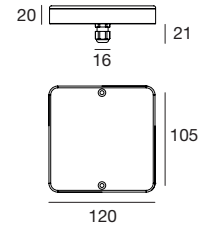

		Cct	lm S - D	Optic
Steel	81691	W 3000	428 - On req	00 General (180°)
		N 4000	456 - On req	

Électronique

89421	99183	83100
ON/OFF 1 art. p 65 x l 74 x h 27	ON/OFF 1 - 2 art. p 80 x l 100 x h 31	DALI 1 - 4 art. p 54 x l 121 x h 26



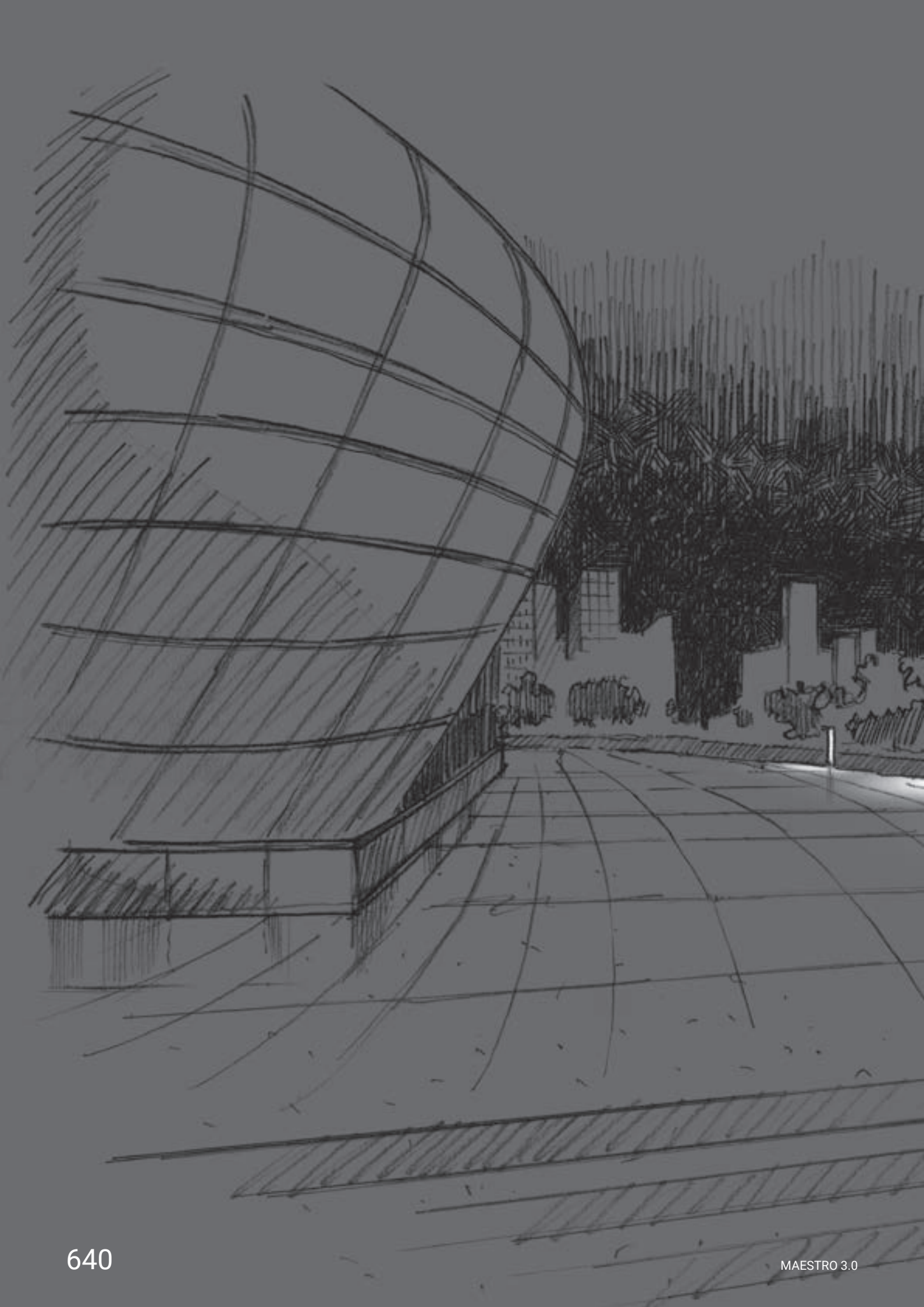

Bollards & Poles

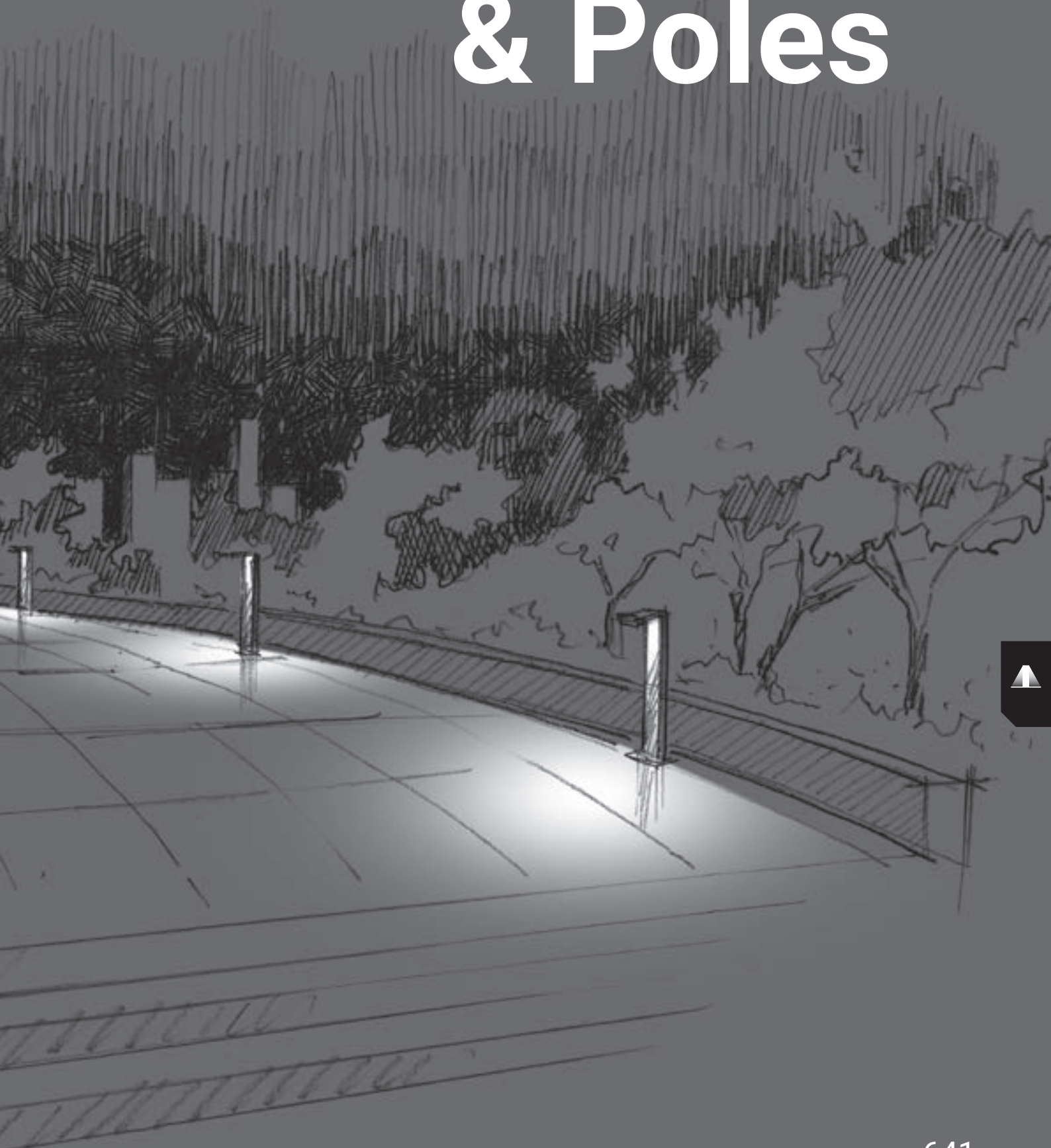

bollards & poles range index

Ryo

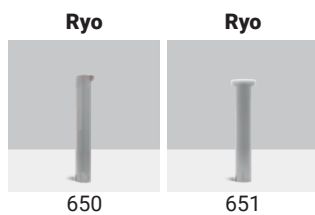

Joe

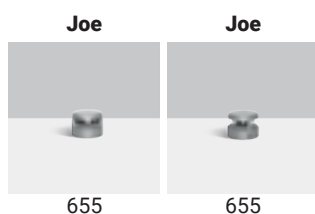

Bond-pro



Puro



Opti-Pole



Peak

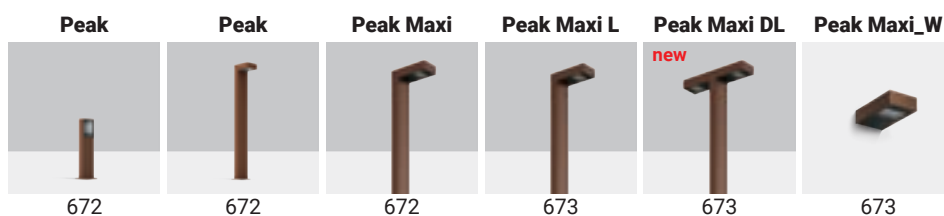

Nail



Apache

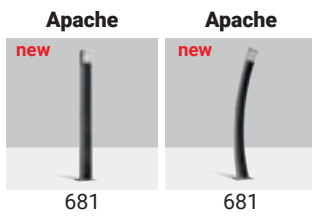

Blum



Pilos



Stalk

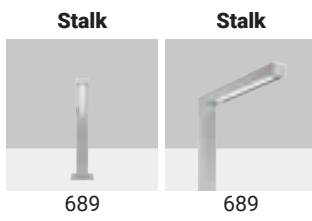

Lino







ryo

Matériaux

Corps en aluminium avec revêtement par poudre de polyester et prétraitement avec protecteur de surface
Diffuseur antichoc en polycarbonate transparent





ryo range

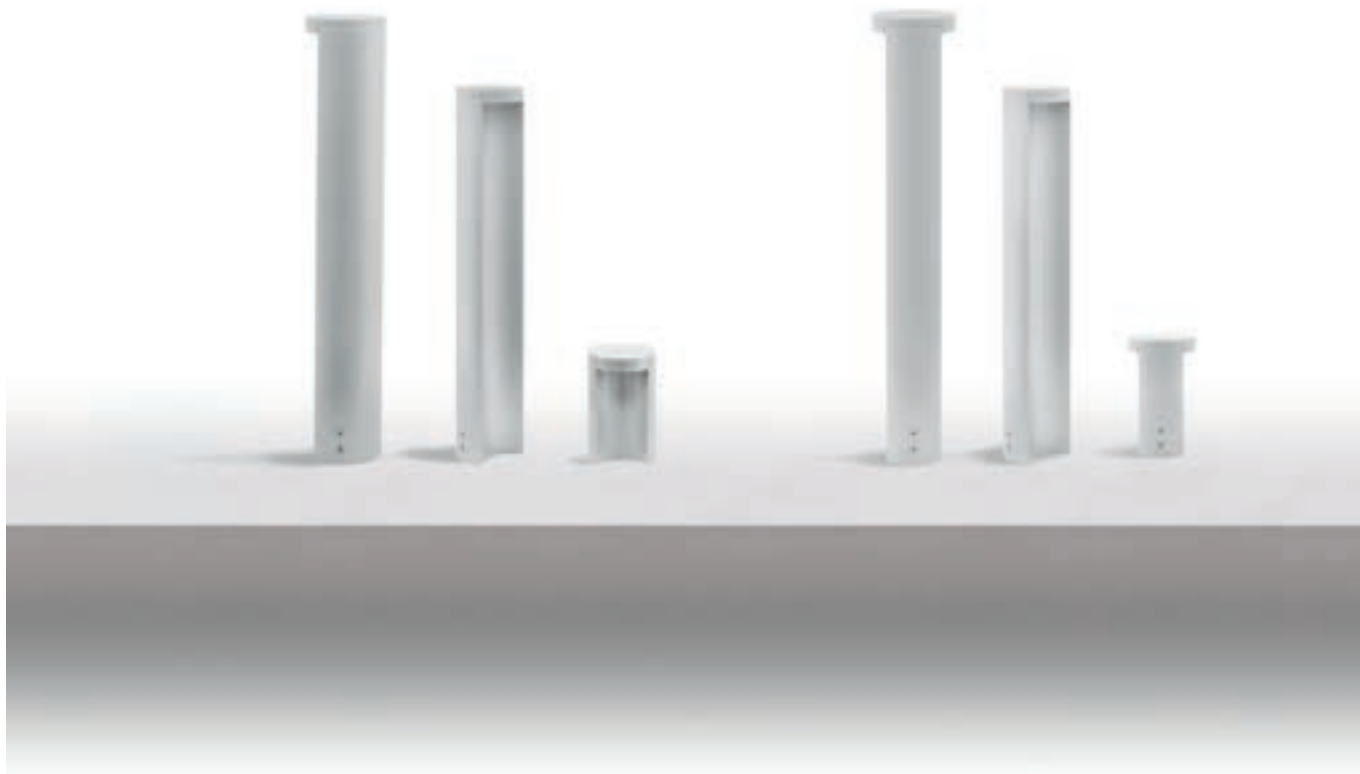

Ryo



4,2 W	250 x Ø150 mm
8,4 W	250 x Ø150 mm
9 W	820 x Ø150 mm 1120 x Ø150 mm
18 W	820 x Ø150 mm 1120 x Ø150 mm
Finish	Grey BK Grey DarkBrown
arrayLED	2700 3000
Optics	General
Driver 	On/Off

ryo lighting concept

Concept

Le nom Ryo indique sa caractéristique la plus spéciale: pendant la nuit, le profil concave de la borne s'anime et est inondé de lumière qui devient décorative et fonctionnelle. L'éclairage du plan vertical permet d'avoir une référence visuelle claire en obscurité et exploite les luminances de la surface vernie en limitant la consommation. L'éclairage au sol est uniforme et profonde, idéal pour des applications résidentielles et publiques.

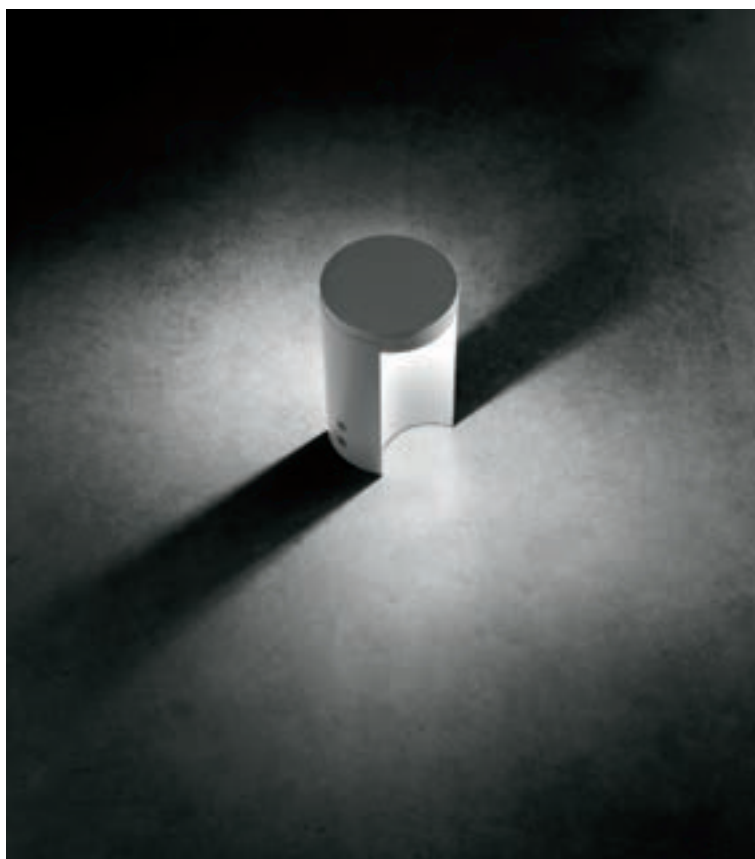

Émission monodirectionnelle

Idéale pour l'éclairage de parcours, cette solution garantit une excellente orientation visuelle et crée du rythme à l'intérieur des cheminements, en délimitant les chemins grâce à la gestion de l'ombre et de la lumière.

64736N00

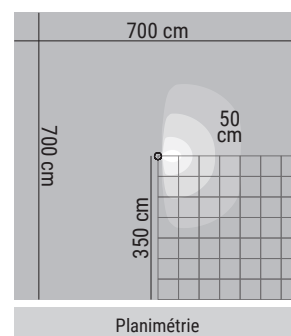
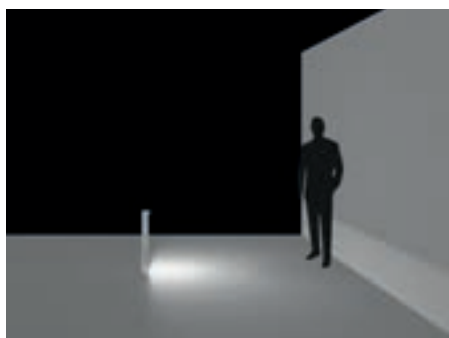

Émission bidirectionnelle

Ce type d'émission est particulièrement fonctionnel à l'éclairage de grands espaces ou de jardins à l'intérieur desquels il est nécessaire de créer des zones de lumière diffuse sur les deux côtés du bollard.

64735W00

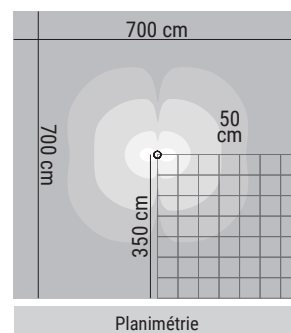

Ryo | Bollards | 198-264 V AC | arrayLED 4,2 W DC - 5,2 W AC

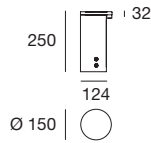

	Cct	Im S - D	Optic
Grey 64761	M 2700	728 - 517	00 General (17°)
BK Grey 64759	W 3000	778 - 535	
DarkBrown 64760			

Accessoires Pag. 651

RTG 64761W00 / 64760W00

Ryo | Bollards | 100-240 V AC | arrayLED 9 W DC - 10 W AC

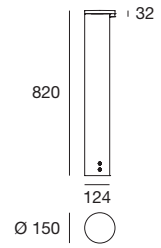
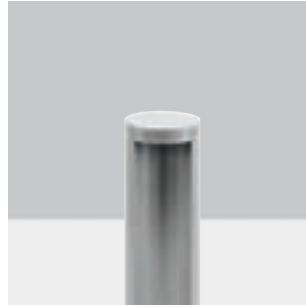

	Cct	Im S - D	Optic
Grey 64734	M 2700	1208 - 1019	00 General (17°)
BK Grey 64721	W 3000	1294 - 1054	
DarkBrown 64726			

Accessoires Pag. 651

RTG 64734W00 / 64726W00

Ryo | Bollards | 100-240 V AC | arrayLED 9 W DC - 10 W AC

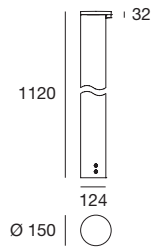

	Cct	Im S - D	Optic
Grey 64736	M 2700	1208 - 1019	00 General (17°)
BK Grey 64723	W 3000	1294 - 1054	
DarkBrown 64728			

Accessoires Pag. 651

Ryo | Bollards | 100-240 V AC | arrayLED 8,4 W DC - 10 W AC

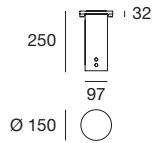

		Cct	lm S - D	Optic
Grey	64764	M 2700	1456 - 1034	00 General (46°)
BK Grey	64762	W 3000	1556 - 1070	
DarkBrown	64763			

Accessoires Pag. 651

Ryo | Bollards | 176-240 V AC | arrayLED 18 W DC - 20 W AC

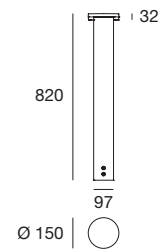

		Cct	lm S - D	Optic
Grey	64735	M 2700	2416 - 2038	00 General (46°)
BK Grey	64722	W 3000	2588 - 2108	
DarkBrown	64727			

Accessoires Pag. 651

Ryo | Bollards | 176-240 V AC | arrayLED 18 W DC - 20 W AC

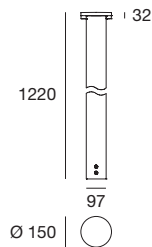

		Cct	lm S - D	Optic
Grey	64737	M 2700	2416 - 2038	00 General (46°)
BK Grey	64724	W 3000	2588 - 2108	
DarkBrown	64729			

Accessoires Pag. 651

Accessoires

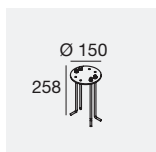

	description	type
64758	Tendeurs de fixation	

suitable for: Ryo

joe

Matériaux

Corps en aluminium avec revêtement par poudre de polyester et prétraitement avec protecteur de surface
Diffuseur en méthacrylate transparent





joe lighting concept

Optics design

L'émission particulière de Joe est le résultat d'une étude minutieuse du corps optique intégré. La source LED à performances élevées est associée à un réflecteur spécial demi-circulaire, réalisé en polycarbonate transparent métallisé avec la technique de pulvérisation. La partie inférieure de la chambre de lumière est revêtue d'un pad en polycarbonate noir demi-brillant à micro-cellules en mesure de contrôler parfaitement la luminance directe de l'appareil.

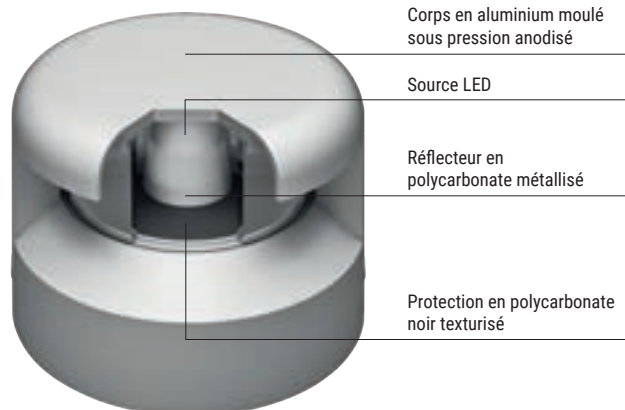

Design robuste

La forme particulière en calotte qui caractérise le profil de Joe rend ce produit extrêmement robuste et résistant, parfait pour les applications dans des espaces extérieurs, publics et privés. L'absence totale d'angles droits garantit une sécurité maximale pour les utilisateurs.



reddot award 2015
winner



Lumière rasante

La distribution de la lumière au sol crée un intéressant jeu d'ombre, parfaitement parallèle au sens de la marche. Cet effet peut être utilisé pour définir des parcours nocturnes et mettre en valeur les espaces verts avec des accents de lumière.

59165W00

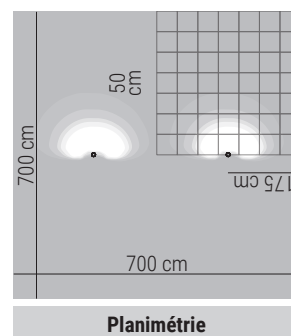
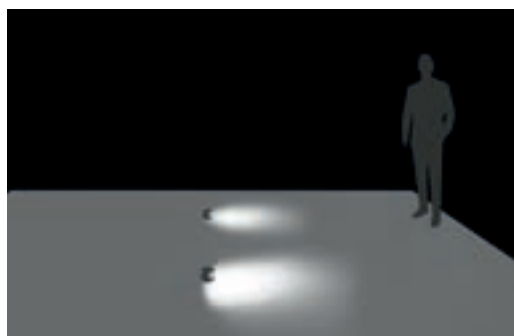

Joe | Bollards | 100-240 V AC | arrayLED 9 W DC - 11 W AC

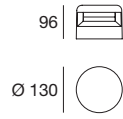
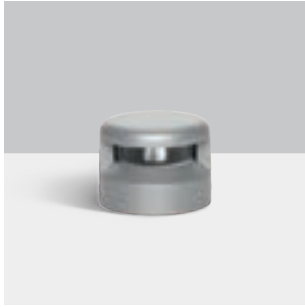

		Cct	lm S - D	Optic
Grey	59165	W 3000	1208 - 380	00 General -
DarkBrown	59166	N 4000	1294 - 380	

Accessoires Pag. 655

RTG 59165W00 / 59166W00

Joe | Bollards | 176-276 V AC | topLED 9 W DC - 11 W AC

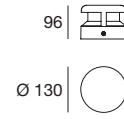

		Cct	lm S - D	Optic
Grey	64635	W 3000	1060 - 514	00 General -
DarkBrown	64636	N 4000	1124 - 545	

Accessoires Pag. 655

Accessoires

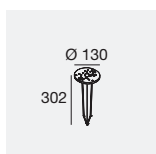

	description	type
14931	Piquet	

suitable for: Joe





bond PRO

Matériaux

Corps en aluminium avec revêtement par poudre de polyester
et prétraitement avec protecteur de surface ou inox
Diffuseur en polyéthylène blanc opalin





bond PRO lighting concept



Design ergonomique

La source de lumière à l'intérieur de la tête du bollard est masquée par la bride circulaire pour un effet cut-off total. Une solution qui permet d'obtenir un éclairage jamais intrusif, conçu pour une intégration maximale avec l'environnement. La lumière émise souligne la forme fuselée du corps du luminaire et éclaire de manière circulaire la surface environnante. La gamme Bond PRO se décline en trois tailles différentes qui permettent d'adapter le produit à différents applications.



81099W00

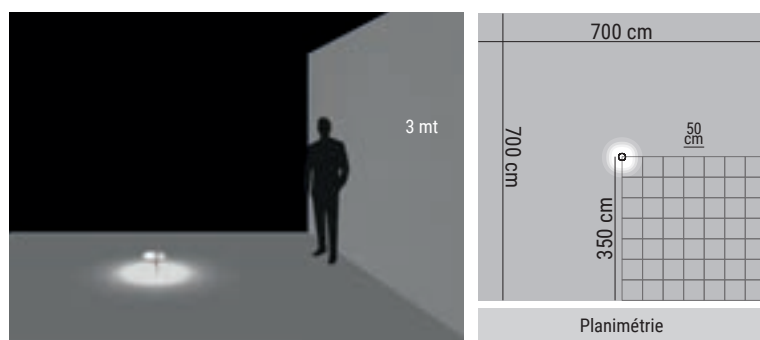

81107W00

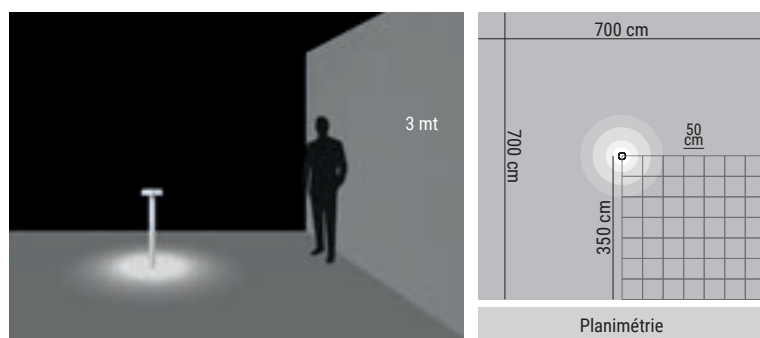

Bond_PRO | Bollards | 220-240 V AC | topLED 10,8 W DC - 12 W AC

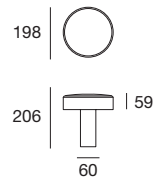

		Cct	lm S - D	Optic
Black	81098	W 3000	1350 - 580	00 General (102°)
DarkBrown	81099	N 4000	1460 - 627	
Steel	81100			
Grey	81097			

Accessoires Pag. 661

Bond_PRO | Bollards | 220-240 V AC | topLED 10,8 W DC - 12 W AC

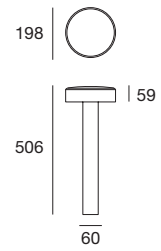

		Cct	lm S - D	Optic
Black	81102	W 3000	1350 - 580	00 General (102°)
DarkBrown	81103	N 4000	1460 - 627	
Steel	81104			
Grey	81101			

Accessoires Pag. 661

Bond_PRO | Bollards | 220-240 V AC | topLED 10,8 W DC - 12 W AC

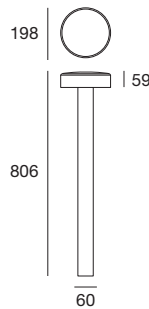

		Cct	lm S - D	Optic
Black	81106	W 3000	1350 - 580	00 General (102°)
DarkBrown	81107	N 4000	1460 - 627	
Steel	81108			
Grey	81105			

Accessoires Pag. 661

Accessoires

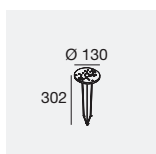

description	type
14931 Piquet	

suitable for: Bond_PRO

puro

Matériaux

Corps en aluminium avec revêtement par poudre de polyester et prétraitement avec protecteur de surface
Diffuseur en verre transparent extra-clair



Puro | Bollards | 198-264 V AC | topLED 13 W DC - 14 W AC

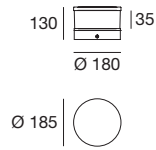

		Cct	lm S - D	Optic
Grey	64715	W 3000	1941 - 1363	00 General (360°)
BK Grey	64716	N 4000	2060 - 1445	
DarkBrown	64610			

Puro | Bollards | 220-240 V AC | topLED 21 W DC - 23 W AC

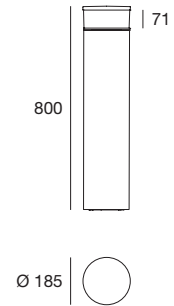

		Cct	lm S - D	Optic
Grey	64700	W 3000	2673 - 1679	00 General (360°)
BK Grey	64701	N 4000	2832 - 1779	
DarkBrown	64611			

Puro | Bollards | 198-264 V AC | topLED 12 W DC - 14 W AC

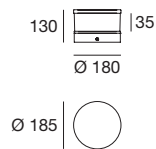

		Cct	lm S - D	Optic
Grey	64719	W 3000	1318 - On req	18 General (180°)
BK Grey	64720	N 4000	1422 - On req	
DarkBrown	64612			

Puro 180° | Bollards | 198-264 V AC | topLED 14 W DC - 15,5 W AC

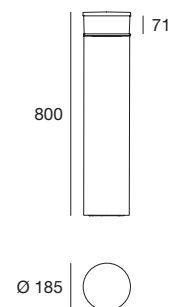

		Cct	lm S - D	Optic
Grey	64717	W 3000	1458 - On req	18 General (180°)
BK Grey	64718	N 4000	1544 - On req	
DarkBrown	64613			

opti-pole

Matériaux

Corps en aluminium avec revêtement par poudre de polyester et prétraitement avec protecteur de surface
Diffuseur en PMMA transparent





opti-pole lighting concept

Design essentiel

La structure d'Opti-Pole, extrêmement réduite et compacte, est conçue pour obtenir un encombrement minimal : de face, la tête du bollard présente une épaisseur de 15 mm seulement ! Les finitions disponibles, sophistiquées, au choix parmi le gris classique, le gris anthracite et le dark brown, enrichissent le produit.



OptiLight™



IK08

IP65



Confort visuel

Opti-Pole adopte la technologie OptiLight pour obtenir un confort visuel unique, en éliminant l'éblouissement direct. La source est placée sur le côté à l'intérieur du bloc optique : les microgravures laser qui caractérisent le diffuseur en PMMA dévient le faisceau lumineux et le distribuent harmonieusement.

L'émission particulière d'Opti-Pole est distribuée sur toute la surface du sol située à l'avant et sur les côtés du bollard jusqu'à atteindre une partie de la surface située à l'arrière.

65395W07

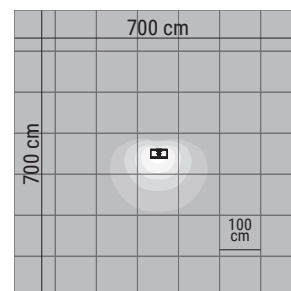
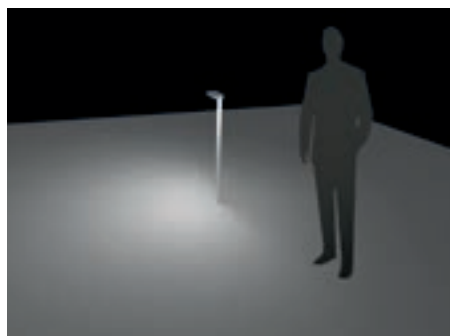

Planimétrie

Opti-pole | Bollards | 100-240 V AC | topLED 8 W DC - 9,5 W AC

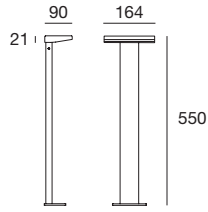

		Cct	lm S - D	Optic
Grey	65392	M 2700	744 - 216	07 Asymm. -
BK Grey	65394	W 3000	780 - 225	
DarkBrown	65393	N 4000	816 - 235	

Accessoires Pag. 667

Opti-pole | Bollards | 100-240 V AC | topLED 8 W DC - 9,5 W AC

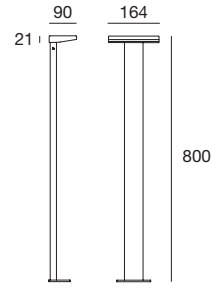

		Cct	lm S - D	Optic
Grey	65395	M 2700	744 - 216	07 Asymm. -
BK Grey	65397	W 3000	780 - 225	
DarkBrown	65396	N 4000	816 - 235	

Accessoires Pag. 667

Metalco | Treviso, Italy



Accessoires

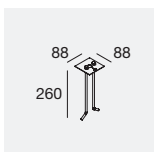

description	type
64200 Tendeurs de fixation	

suitable for: Opti-pole

peak

Matériaux

Corps en aluminium avec revêtement par poudre de polyester et prétraitement avec protecteur de surface
Diffuseur en verre transparent extra-clair





peak range



	Peak	Peak	Peak-Maxi	Peak-Maxi_L	Peak-Maxi_DL	Peak-Maxi_W
6,5 W	350 x 90 mm	-	-	-	-	-
9,5 W	750 x 90 mm	750 x 90 mm	-	-	-	-
12 W	-	-	-	-	-	-
24 W	-	-	-	-	-	-
36 W	-	-	3008 x 180 mm	-	-	330 x 180 mm
45 W	-	-	-	-	-	-
53 W	-	-	-	4500 x 180 mm	-	-
106 W	-	-	-	-	4500 x 180 mm	-
Finish	Grey BK Grey DarkBrown	Grey BK Grey DarkBrown	Grey BK Grey DarkBrown	Grey BK Grey DarkBrown	Grey BK Grey DarkBrown	Grey BK Grey DarkBrown
topLED	3000 4000	3000 4000	3000 4000	3000 4000	3000 4000	3000 4000
Optics	Asymmetric	Asymmetric	Asymmetric	Asymmetric	Asymmetric	Asymmetric
Driver	On/Off	On/Off - DALI	On/Off - DALI	On/Off - DALI	On/Off - DALI	On/Off - DALI

Optics design

La conformation particulière du groupe optique intégré permet de faire sortir la lumière exclusivement de la partie frontale du bollard, en éliminant tout résidu de lumière secondaire sur la partie postérieure du corps. L'émission est profonde, nette et définie.

Verre trempé épaisseur 6 mm extra clair avec sérigraphie noire

TopLED et lentilles dédiées en PMMA

Groupe optique en aluminium moulé sous pression, anodisé et verni

Corps en aluminium extrudé avec traitement de protection de la surface et vernis en poudres de polyester



Contrôle et performance

Unités lumineuses dotées de lentilles dédiées qui gèrent la distribution de la lumière avec un contrôle optimal. Des effets asymétriques capables d'éclairer la circulation secondaire, places, parcs et jardins.



Une réponse à toute exigence

Des versions pour application au mur, bollard aux dimensions et puissances diverses, des poteaux architecturaux simples et doubles et la solution particulière en arc assurent une solution dédiée pour toute exigence d'installation. Peak permet de réaliser facilement des installations même en milieu urbain, avec une flexibilité optimale, afin de garantir un projet d'éclairage et architectural professionnel très efficace.



Peak | Bollards | 198-264 V AC | arrayLED 6,5 W DC - 9 W AC

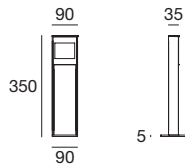

	Cct	Im S - D	Optic
Grey 64794	W 3000	988 - 575	07 Asymm. -
BK Grey 64795	N 4000	1058 - 595	
DarkBrown 64796			

Accessoires Pag. 673

RTG **64796W07 / 64794W07**

Peak | Bollards | 100-240 V AC | arrayLED 9,5 W DC - 11 W AC

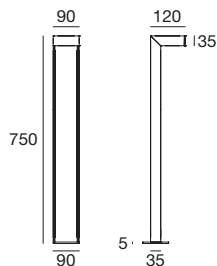

	Cct	Im S - D	Optic
Grey 64788	W 3000	1208 - 537	07 Asymm. -
BK Grey 64789	N 4000	1294 - 555	
DarkBrown 64790			

DALI	Cct	Im S - D	Optic
Grey 65403	W 3000	1208 - 537	07 Asymm. -
BK Grey 65404	N 4000	1294 - 555	
DarkBrown 65405			

Accessoires Pag. 673

RTG **64790W07 / 64788W07 / 64789W07**

Peak | Bollards | 100-240 V AC | arrayLED 9,5 W DC - 11 W AC

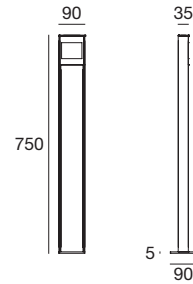

	Cct	Im S - D	Optic
Grey 64791	W 3000	1208 - 775	07 Asymm. -
BK Grey 64792	N 4000	1294 - 800	
DarkBrown 64793			

Accessoires Pag. 673

Peak-Maxi | Poles | 198-264 V AC | powerLED 36 W DC - 39 W AC

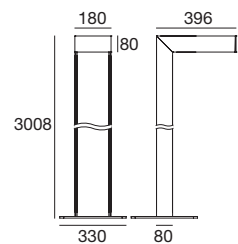

	Cct	Im S - D	Optic
Grey 65073	W 3000	4860 - 3437	07 Asymm. -
BK Grey 65074	N 4000	5214 - 2764	
DarkBrown 65072			

DALI	Cct	Im S - D	Optic
Grey 65406	W 3000	4860 - 3437	07 Asymm. -
BK Grey 65407	N 4000	5214 - 2764	
DarkBrown 65408			

Accessoires Pag. 673

Peak-Maxi_L | Poles | 198-264 V AC | powerLED 53 W DC - 59 W AC

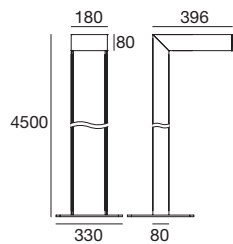

		Cct	Im S - D	Optic
Grey	65064	W 3000	7290 - 4146	07 Asymm. -
BK Grey	65065	N 4000	7821 - 5156	
DarkBrown	65063			

DALI		Cct	Im S - D	Optic
Grey	65400	W 3000	7290 - 4146	07 Asymm. -
BK Grey	65401	N 4000	7821 - 5156	
DarkBrown	65402			

Accessoires Pag. 673

Peak-Maxi_W | Wall Lights | 198-264 V AC | powerLED 36 W DC - 39 W AC

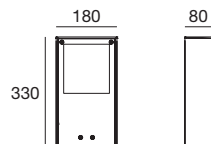

		Cct	Im S - D	Optic
Grey	65084	W 3000	4860 - 2764	07 Asymm. -
BK Grey	65085	N 4000	5214 - 3437	
DarkBrown	65083			

DALI		Cct	Im S - D	Optic
Grey	65409	W 3000	4860 - 2764	07 Asymm. -
BK Grey	65410	N 4000	5214 - 3437	
DarkBrown	65411			

Peak-Maxi_DL | Poles | 198-264 V AC | powerLED 106 W DC - 118 W AC

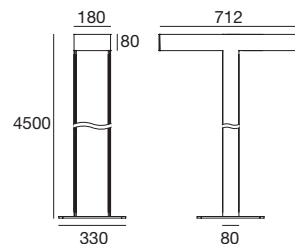

		Cct	Im S - D	Optic
Grey	64300	W 3000	14580 - On req	07 Asymm. -
BK Grey	64301	N 4000	15642 - On req	
DarkBrown	64302			

DALI		Cct	Im S - D	Optic
Grey	65197	W 3000	14580 - On req	07 Asymm. -
BK Grey	65198	N 4000	15642 - On req	
DarkBrown	65199			

Accessoires Pag. 673

Accessoires

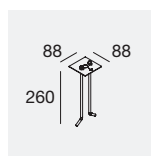

description	type
65082 Tendeurs de fixation	
suitable for: Peak 6,5W / Peak 9,5W	

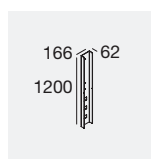

description	type
65078 Base pour fixation	
suitable for: Peak Maxi / Peak Maxi L / Peak Maxi DL	

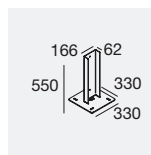

description	type
65076 Base pour fixation	Grey
65077 Base pour fixation	BK Grey
65075 Base pour fixation	DarkBrown
suitable for: Peak Maxi / Peak Maxi L / Peak Maxi DL	





nail

Matériaux

Corps en aluminium

Diffuseur en polycarbonate



Nail | Bollards | 100-240 V AC | powerLED 6W DC - 7W AC

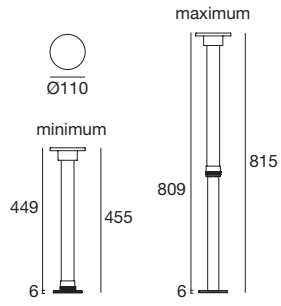

		Cct	lm S - D	Optic
BK Grey	84189	M 2700	532 - On req	00 General -
DarkBrown	84190	W 3000	569 - On req	
Grey	84191	N 4000	614 - On req	
Sand	84192			

Available from April 2021

Nail Bollards

La caractéristique principale de Nail bollard est la possibilité de faire varier la hauteur du poteau grâce au système télescopique breveté qui fait de ce luminaire un produit unique en son genre. L'orientation de la source reste fixe, tandis que le réglage de la hauteur permet de faire varier la surface de sol éclairée et l'intensité d'éclairage.

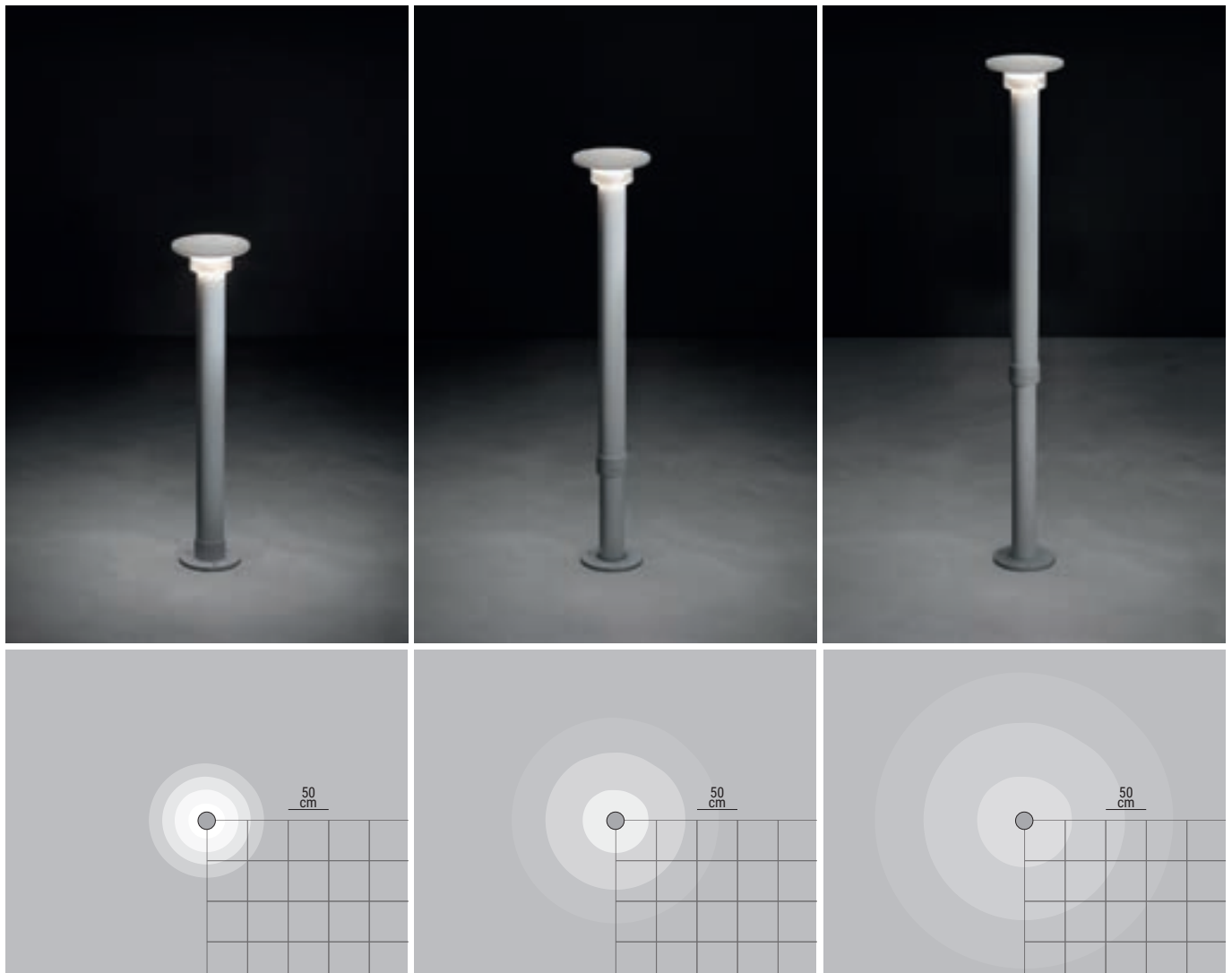

apache

Matériaux

Corps en aluminium avec revêtement en poudre de polyester et prétraitement avec protecteur de surface
Diffuseur en polycarbonate transparent





apache

design Rigo Architeti

Optique 180°

Grâce à la source topLED inclinée vers l'intérieur et à la forme creuse de la partie frontale, la courbe lumineuse est projetée vers la zone du sol derrière la base, puis s'ouvre à 180° et se diffuse uniformément devant le poteau. Une émission conçue pour les installations à proximité d'un mur : la lumière propage vers la zone de passage en partant précisément de la base du mur, même si Apache est installé quelques centimètres plus loin.

Émission homogène

L'émission d'Apache est exempte de cônes d'ombre, propre et performante. Au sol, à moins de 1,5 mètre de la base de la lampe, l'éclairage minimum ne descend jamais en dessous de 10 lux, pour une lumière toujours homogène et fonctionnelle.

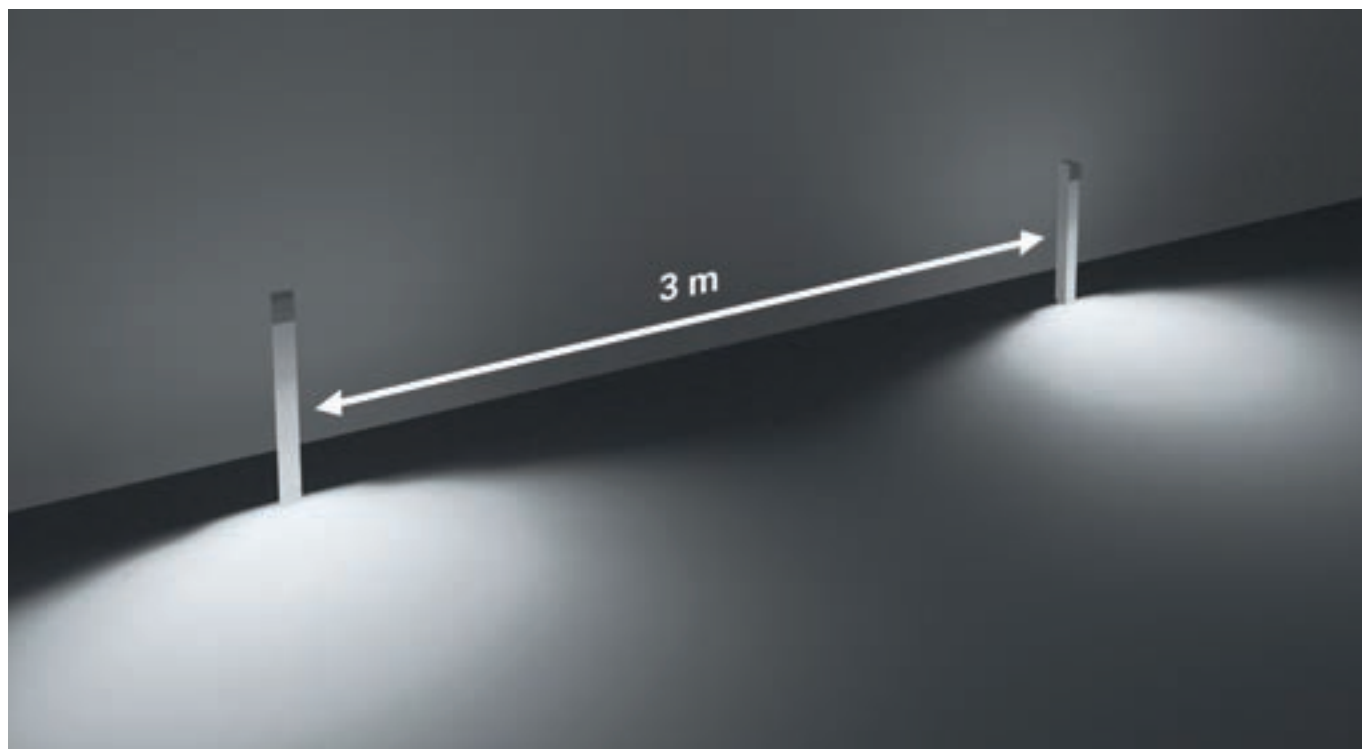

Source cut-off en retrait

Située sur le sommet du poteau, la source est entièrement cachée. Apache est un luminaire au confort visuel extrêmement élevé : la lumière « glisse » le long du corps creux et se diffuse une fois au sol, sans jamais éblouir le passant, même lorsque ce dernier regarde directement le poteau.



Apache | Bollards | 198-264 V AC | topLED 7 W DC - 8 W AC

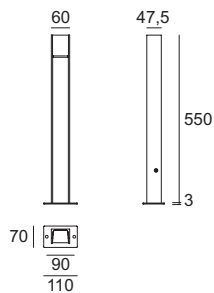

		Cct	lm S - D	Optic
BK Grey	64252	M 2700	992 - On req	00 General -
Gr BK	64253	W 3000	1034 - On req	
DarkBrown	64254	N 4000	1087 - On req	
Sand	64255			

Accessoires Pag. 681

Apache | Bollards | 198-264 V AC | topLED 9 W DC - 10 W AC

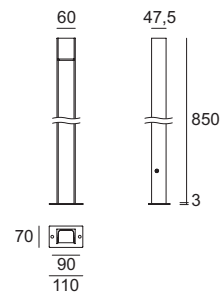

		Cct	lm S - D	Optic
BK Grey	64256	M 2700	1198 - On req	00 General -
Gr BK	64257	W 3000	1249 - On req	
DarkBrown	64258	N 4000	1313 - On req	
Sand	64259			

Accessoires Pag. 681

Apache | Bollards | 198-264 V AC | topLED 7 W DC - 9 W AC

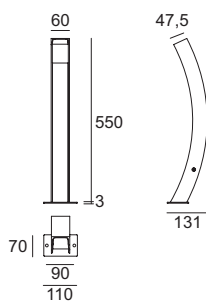

		Cct	lm S - D	Optic
BK Grey	64262	M 2700	992 - On req	00 General -
Gr BK	64263	W 3000	1034 - On req	
DarkBrown	64264	N 4000	1087 - On req	
Sand	64265			

Accessoires Pag. 681

Apache | Bollards | 198-264 V AC | topLED 9 W DC - 10 W AC

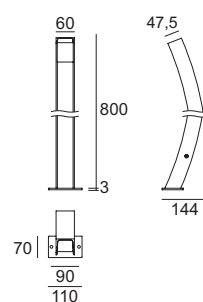

		Cct	lm S - D	Optic
BK Grey	64266	M 2700	1198 - On req	00 General -
Gr BK	64267	W 3000	1249 - On req	
DarkBrown	64268	N 4000	1313 - On req	
Sand	64269			

Accessoires Pag. 681

Accessoires

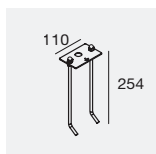

description	type
64210 Tendeurs de fixation	
suitable for: Apache	

blum

Matériaux

Corps en PVC/aluminium
Diffuseur en PMMA





Blum | Bollards | 100-240 V AC | 1 x powerLEDs 1,5 W DC - 1,8 W AC

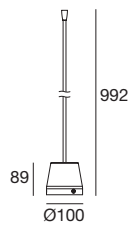

	Cct	Im S - D	Optic
Brown 83875	M 2700	199 - On req	20 Spot -
	W 3000	213 - On req	00 General -
	N 4000	227 - On req	

Accessoires Pag. 685

Blum | Bollards | 100-240 V AC | 3 x powerLEDs 4,5 W DC - 5,4 W AC

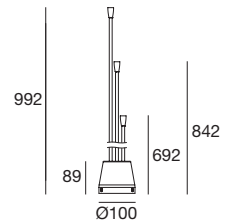

	Cct	Im S - D	Optic
Brown 83879	M 2700	597 - On req	20 Spot -
	W 3000	639 - On req	00 General -
	N 4000	681 - On req	

Accessoires Pag. 685

Blum | Bollards | 100-240 V AC | 1 x powerLEDs 1,5 W DC - 1,8 W AC

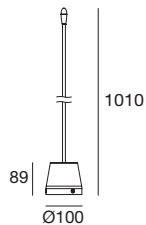

	Cct	Im S - D	Optic
Brown 83876	M 2700	199 - On req	00 General -
	W 3000	213 - On req	
	N 4000	227 - On req	

Accessoires Pag. 685

Blum | Bollards | 100-240 V AC | 3 x powerLEDs 4,5 W DC - 5,4 W AC

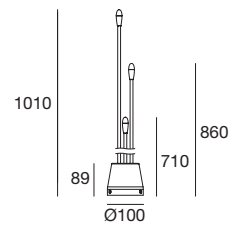

	Cct	Im S - D	Optic
Brown 83880	M 2700	597 - On req	00 General -
	W 3000	639 - On req	
	N 4000	681 - On req	

Accessoires Pag. 685

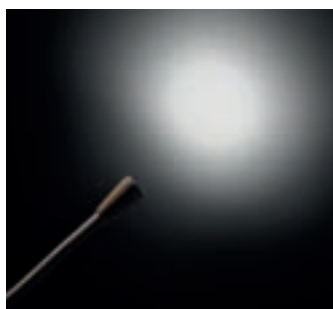

Spot

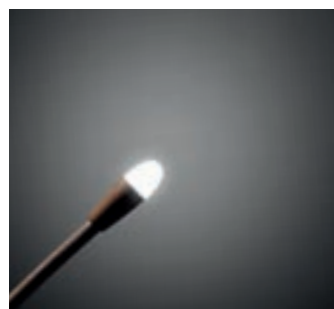

General



Fleur fermée



Fleur ouverte

Blum Flower | Bollards | 100-240 V AC | 1 x powerLEDs 1,5 W DC - 1,8 W AC

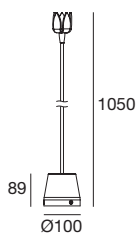

		Cct	Im S - D	Optic
Brown	83877	M 2700	199 - On req	00 General -
		W 3000	213 - On req	
		N 4000	227 - On req	

Accessoires Pag. 685

Blum Flower | Bollards | 100-240 V AC | 3 x powerLEDs 4,5 W DC - 5,4 W AC

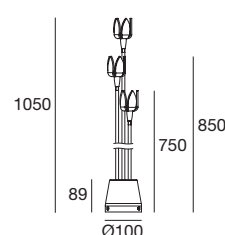

		Cct	Im S - D	Optic
Brown	83881	M 2700	597 - On req	00 General -
		W 3000	639 - On req	
		N 4000	681 - On req	

Accessoires Pag. 685

Blum Flower | Bollards | 100-240 V AC | 1 x powerLEDs 1,5 W DC - 1,8 W AC

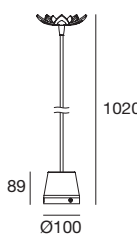

		Cct	Im S - D	Optic
Brown	83878	M 2700	199 - On req	00 General -
		W 3000	213 - On req	
		N 4000	227 - On req	

Accessoires Pag. 685

Blum Flower | Bollards | 100-240 V AC | 3 x powerLEDs 4,5 W DC - 5,4 W AC

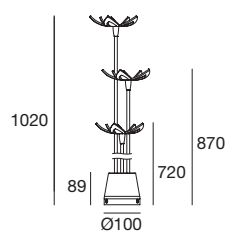

		Cct	Im S - D	Optic
Brown	83882	M 2700	597 - On req	00 General -
		W 3000	639 - On req	
		N 4000	681 - On req	

Accessoires Pag. 685

Accessoires

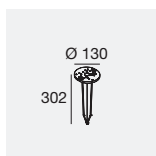

	description	type
14931	Piquet	
suitable for: Blum / Blum Flower		



	description	type
83883	Fleur fermée	
suitable for: Blum Flower		

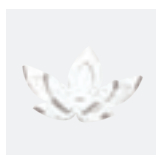

	description	type
83884	Fleur ouverte	
suitable for: Blum Flower		

pilos

Matériaux

Corps en aluminium avec revêtement par poudre de polyester et prétraitement avec protecteur de surface.
Diffuseur en polycarbonate satiné.



Pilos | Bollards | 198-264 V AC | topLED 6 W DC - 7 W AC

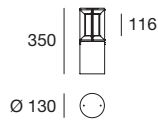

		Cct	lm S - D	Optic
Grey	61125	W 3000	728 - 344	00 General (180°)
		N 4000	755 - 371	

Accessoires Pag. 687

Pilos | Bollards | 198-264 V AC | topLED 6 W DC - 7 W AC

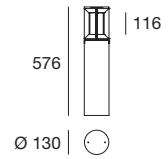
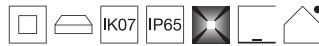

		Cct	lm S - D	Optic
Grey	61115	W 3000	728 - 344	00 General (180°)
		N 4000	755 - 371	

Accessoires Pag. 687

Pilos | Bollards | 220-240 V AC | topLED 12 W DC - 13 W AC

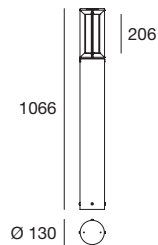

		Cct	lm S - D	Optic
Grey	61145	W 3000	1456 - 716	00 General (180°)
		N 4000	1510 - 772	

Accessoires Pag. 687

Accessoires



description	type
59950 Tendeurs de fixation	
suitable for: Pilos 6W / Pilos 12W	

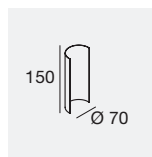

description	type
58675 Réflecteur	
suitable for: Pilos 6W	

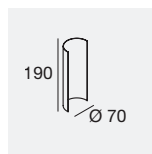

description	type
58685 Réflecteur	
suitable for: Pilos 12W	

stalk

Matériaux

Corps en aluminium avec revêtement par poudre de polyester et prétraitement avec protecteur de surface
Diffuseur en polyéthylène blanc opalin



Stalk | Bollards | 100-240 V AC | topLED 4 W DC - 5 W AC

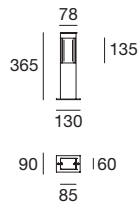

	Cct	Im S - D	Optic
Grey 63455	W 3000	414 - 78	00 General (120°)
DarkBrown 63456	N 4000	440 - 98	

Accessoires Pag. 689

Stalk | Bollards | 100-240 V AC | topLED 4 W DC - 5 W AC

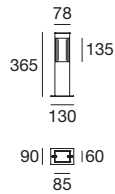

	Cct	Im S - D	Optic
Grey 63495	W 3000	414 - 157	00 General (120°)
DarkBrown 63496	N 4000	440 - 196	

Accessoires Pag. 689

Stalk | Bollards | 180-264 V AC | topLED 20 W DC - 21 W AC

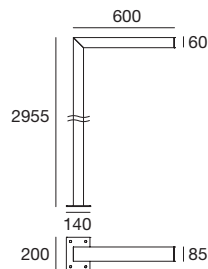

	Cct	Im S - D	Optic
Grey 63445	W 3000	1656 - 791	00 General (115°)
DarkBrown 63446	N 4000	1757 - 840	

Accessoires Pag. 689

Stalk | Bollards | 180-264 V AC | topLED 9 W DC - 10 W AC

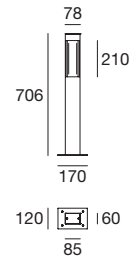

	Cct	Im S - D	Optic
Grey 63465	W 3000	828 - 157	00 General (120°)
DarkBrown 63466	N 4000	879 - 196	

Accessoires Pag. 689

Stalk | Bollards | 180-264 V AC | topLED 9 W DC - 10 W AC

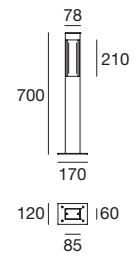
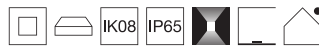

	Cct	Im S - D	Optic
Grey 63505	W 3000	828 - 313	00 General (120°)
DarkBrown 63506	N 4000	879 - 392	

Accessoires Pag. 689

Accessoires

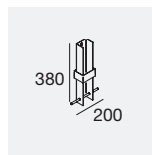

description	type
56990 Base pour fixation	
suitable for: Stalk	

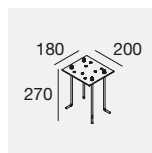

description	type
53890 Tendeurs de fixation	
suitable for: Stalk	



lino

Matériaux

Corps en inox

Diffuseur en verre transparent extra-clair

Lino | Bollards | 24V DC | powerLED 1 W DC

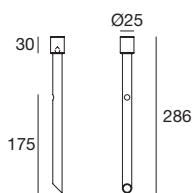

		Cct	Im S - D	Optic
Steel	83763	M 2700	98 - On req	00 General -
		W 3000	106 - On req	
		N 4000	112 - On req	

Électronique

89488	89179	89359	99332	99722
ON/OFF 1 - 14 art.	ON/OFF 1 - 24 art.	ON/OFF 1 - 48 art.	0/1-10V 1 - 150 art.	DALI 1 - 120 art.
p 80 x l 100 x h 31	p 92 x l 117 x h 38	p 115 x l 140 x h 50	p 150 x l 160 x h 35	p 191 x l 163 x h 38

lino

design IN-VISIBILE lab



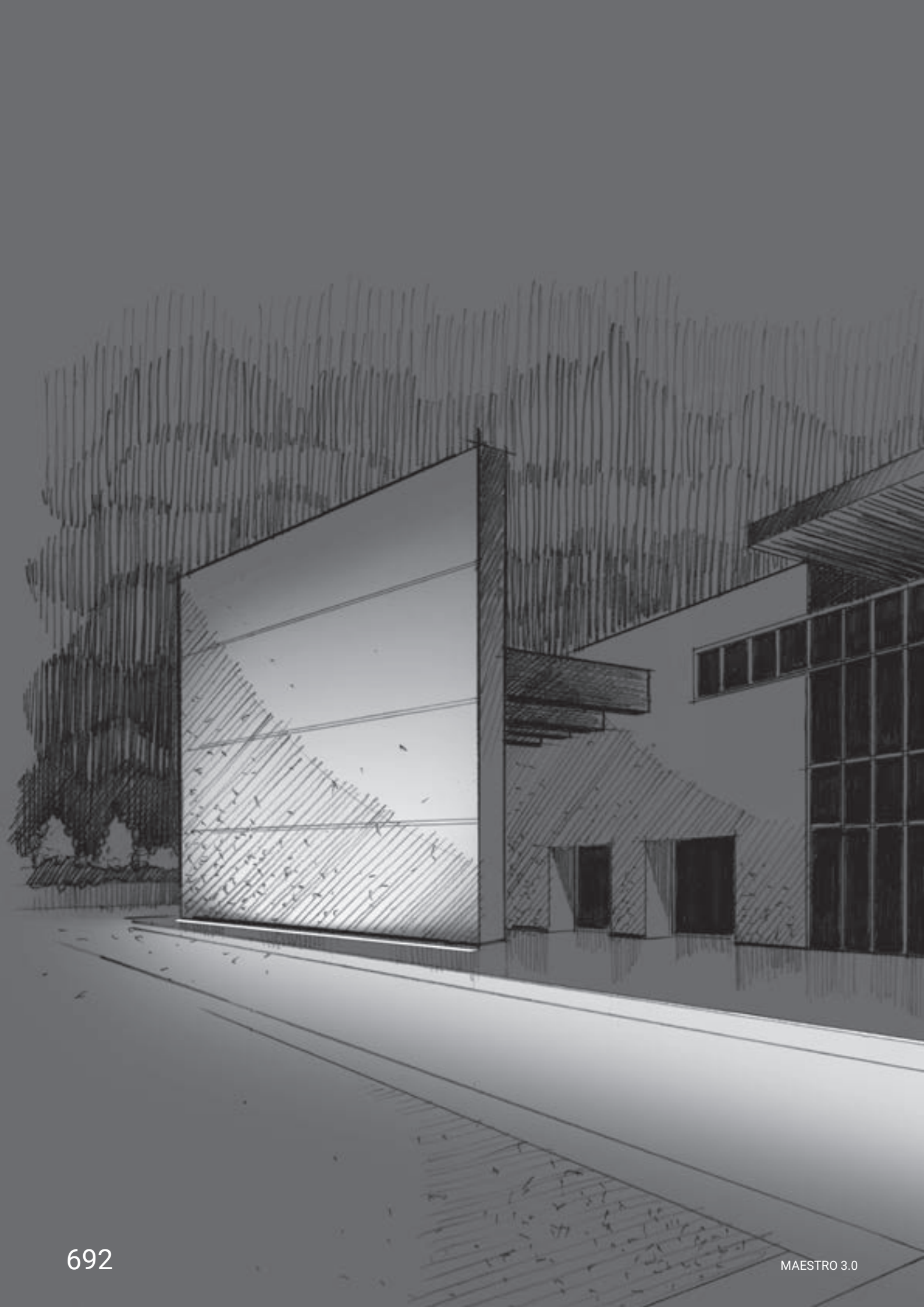

Linear lights

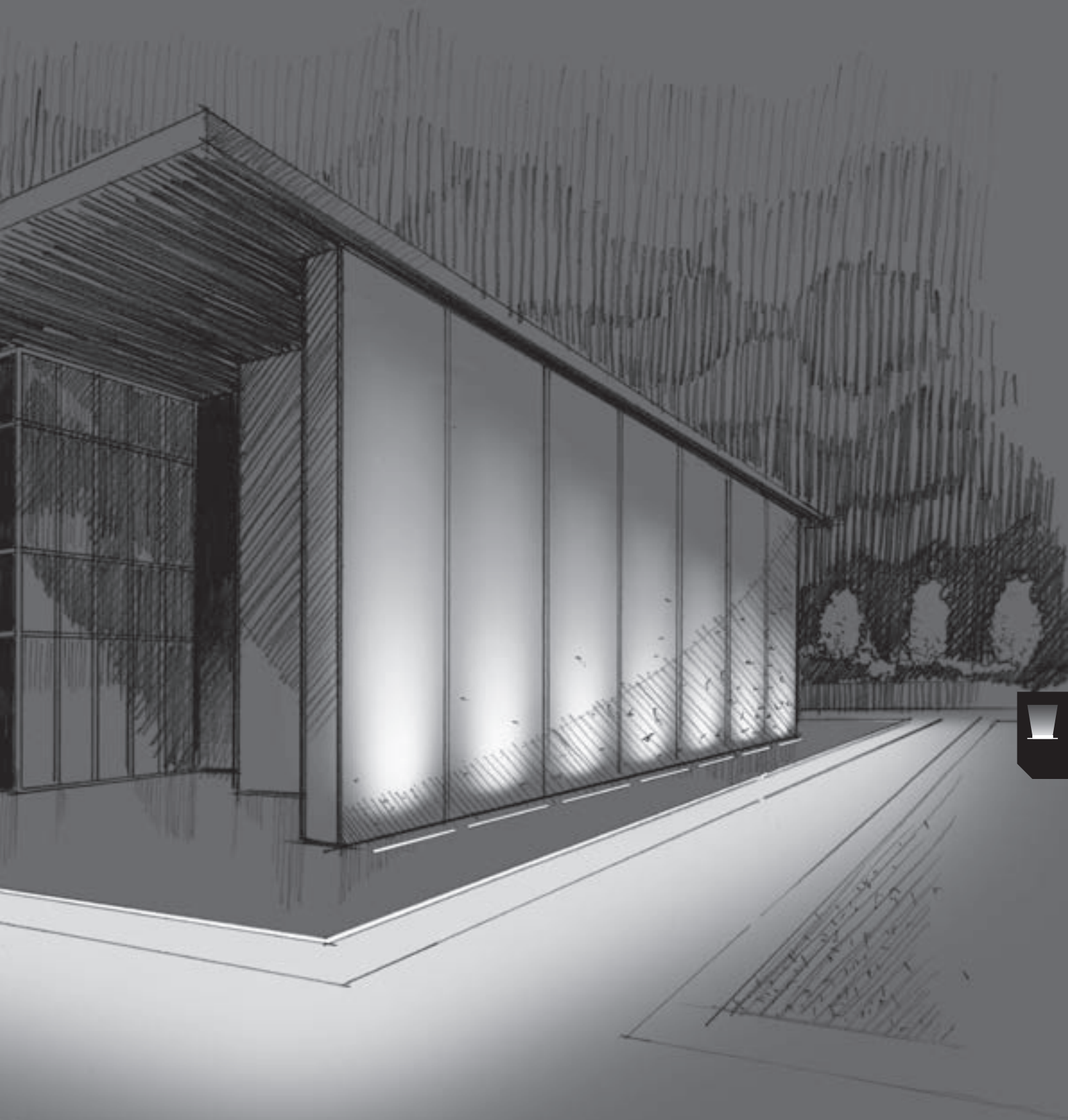

linear lights range index

Archiline



Xenia

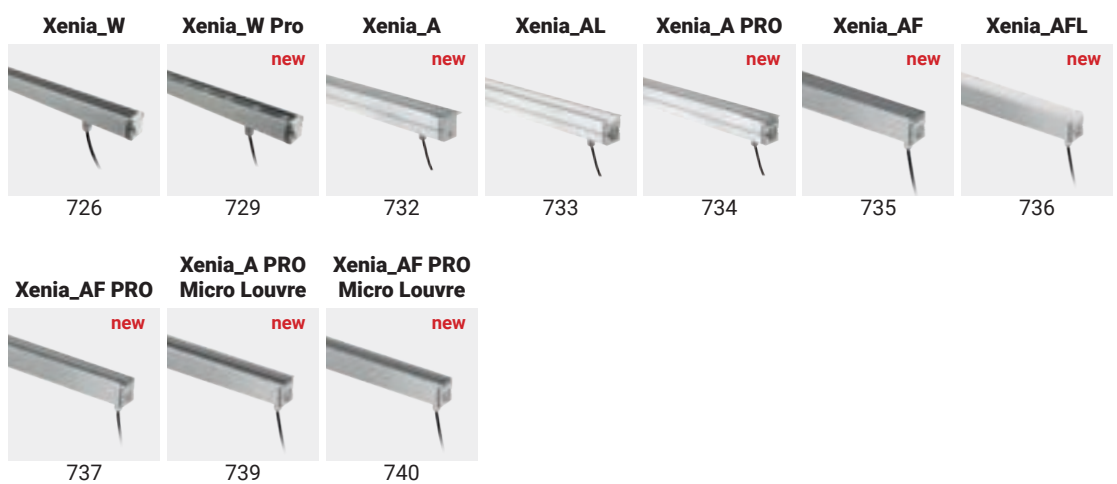

Paseo



Thin66

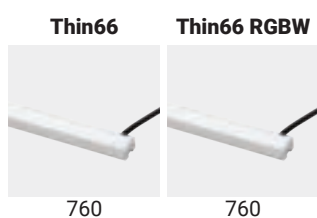

Ice-Cut66

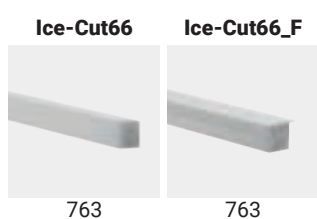

Skin

Skin_FL



768

Skin_S



768

Skin_F



768

Skin_Y



768

Dirigo

Dirigo



774

Fylo+

**Fylo+ Out
Recessed**



782





linear lighting features

Fabrication de qualité

Les nouvelles familles de profils linéaires se distinguent grâce à :

- l'utilisation de matériaux de haute qualité, dont l'alliage d'aluminium EN AW-6060, l'inox AISI 316L, le verre trempé et des résines de silicone spéciales ;

- une précision élevée dans le cadre des tests de résistance mécanique aux vibrations, aux contraintes et aux chocs, des tests de résistance aux températures extrêmes (de -20 °C à +60 °C), ainsi que des divers essais climatiques ;

- un savoir-faire important en matière de développement de mécanismes et systèmes de protection contre les surtensions (OVP), les décharges électrostatiques (ESD), l'humidité à l'intérieur du corps de la lampe (TCS) et le contact de l'eau avec les conducteurs AquaStop®.



Step MacAdam <0,5

Afin d'assurer l'uniformité des couleurs non seulement dans le temps, mais également entre différents produits d'un même projet d'éclairage, nous avons sélectionné les meilleurs fabricants de LED pour garantir une sélection constante et répétitive de LED. MacAdam <0,5 est pour nous un standard de qualité : la valeur 0,5 signifie que la différence est invisible à l'œil nu et que les LED sont considérées comme étant d'excellente qualité.



MacAdam < 0,5



Inhomogénéité chromatique

Gamme de couleurs

Avec i-LèD, le concepteur dispose d'une large gamme de températures de couleur, allant du blanc chaud (2700 K) aux tons correspondant à une lumière naturelle (4000 K), pour une polyvalence totale lors de la conception. La lumière blanche est accompagnée de l'offre RGB pour des effets de lumière colorés statiques ou dynamiques. L'introduction du système RGBW (blanc séparé des trois couleurs RGB à l'intérieur de la diode) offre une possibilité supplémentaire au concepteur qui peut compter aussi bien sur un meilleur mélange des couleurs pour ses mises en scène que sur une lumière blanche pure.



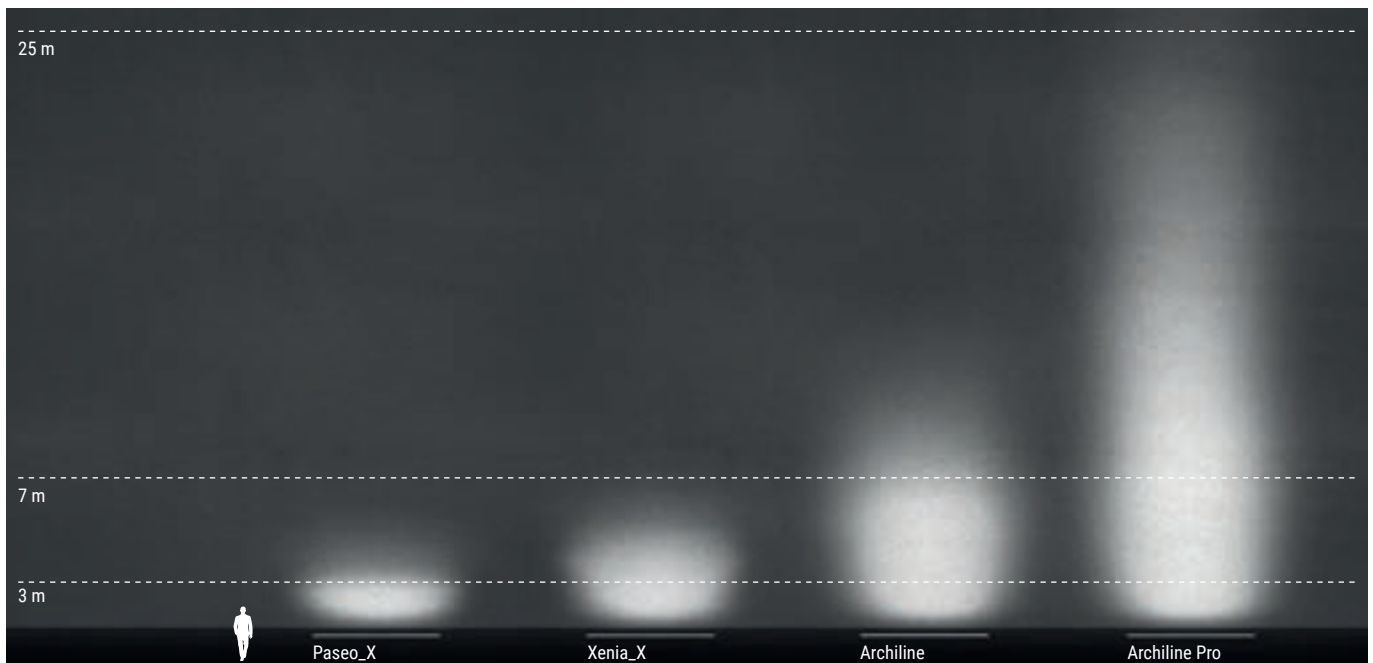

Des performances réponsants à tout besoin

Chaque famille de profils propose une éventail diversifié de puissances pour répondre à un maximum de besoins en matière d'éclairage. Par exemple, les modèles Paseo, Xenia, Archiline et Archiline PRO possèdent une gamme de puissance extraordinairement étendue. Il est à noter que tous les articles de la section Linear Lights sont à intensité variable via les protocoles 1-10V, DALI, DMX et RDM pour un contrôle total - via communication bidirectionnelle - des paramètres DMX.

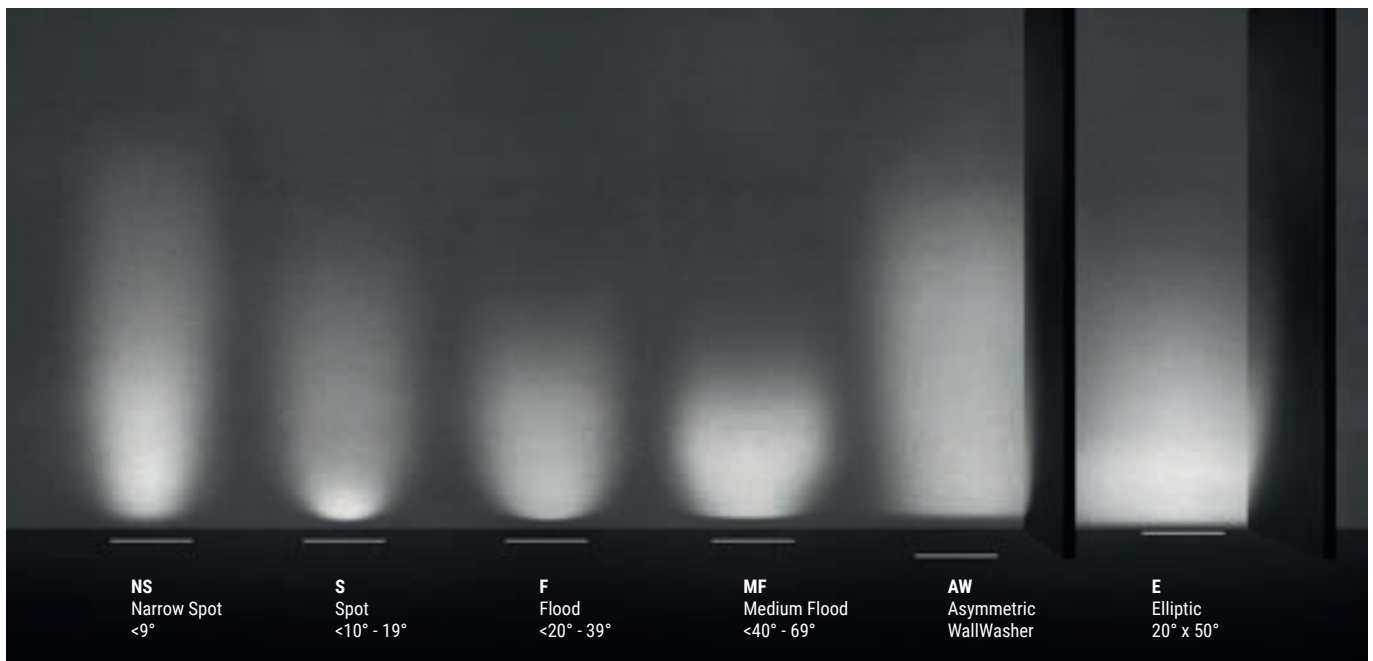

Gamme d'optiques

La gamme Linear Lights propose des produits spécifiques pour tous les contextes, se déclinant en différentes solutions d'éclairage en fonction de l'optique utilisée. Plusieurs variantes sont proposées pour le bloc optique de la série en question : spot et narrow spot – pour des angles de diffusion étroits ou très étroits –, optiques flood variées, optique diffuse et optiques lèche-mur, à savoir Elliptic $20^\circ \times 50^\circ$ pour une émission ovalisée et un éclairage lèche-mur pour murs hauts et étroits, ou Asymmetric pour un faisceau directionnel qui rase le mur de manière homogène.

archiline

Matériaux du modèle à encastrement

6060 Bride en alliage d'aluminium 6060 anodisé ou en inox AISI 316L. Diffuseur en verre trempé extra-clair ou en verre trempé avec peinture céramique blanche

Matériaux du modèle pour mur/plafond

Corps en alliage d'aluminium 6060 anodisé ou en inox AISI 316L. Diffuseur en verre trempé extra-clair





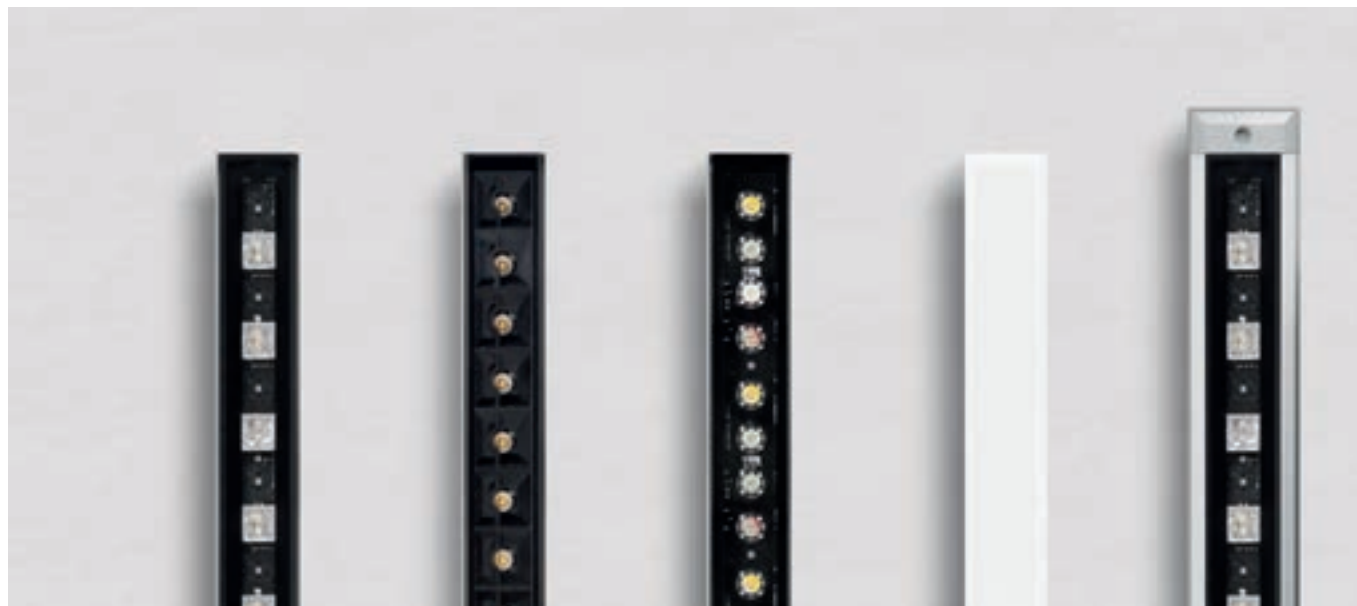

	_F / _FJ frameless	_F frameless Anti-glaring	_F frameless RGBW DMX	_FL frameless Opaline	_A frame
3,6 W	-	-	-	321 x 45 mm	-
6 W	-	-	-	511 x 45 mm	-
8,4 W	-	-	-	321 x 45 mm	-
11,2 W 13,6 W	321 x 45 mm	321 x 45 mm	321 x 45 mm	1001 x 45 mm 511 x 45 mm	371 x 62 mm
18,3 W 19,8 W	511 x 45 mm 501 x 45 mm	511 x 45 mm	-	-	561 x 62 mm
22 W	-	-	511 x 45 mm	-	-
24 W	-	-	-	1001 x 45 mm	-
36,5 W 39,6 W	1001 x 45 mm	1001 x 45 mm	-	-	1051 x 62 mm
44W	-	-	1001 x 45 mm	-	-
55 W 59 W	-	-	-	-	1541 x 62 mm
Finish	Anod. Bk.	Anod. Bk.	Anod. Bk.	Anod. Bk.	Anod. Al.
powerLED	2700K - 3000K 4000K	2700K - 3000K 4000K	RGBW	3000K - 4000K RGBW	2700K - 3000K 4000K
Optics	Narrow Spot (_FJ) Spot Flood Wide Flood Elliptic Asymmetric	Spot Flood Wide Flood Elliptic	Spot Flood Wide Flood Elliptic Asymmetric	General	Spot Flood Wide Flood Elliptic Asymmetric
Driver 	On/Off DALI	On/Off DALI	DMX	On/Off DMX	On/Off DALI



	_A Frame Anti-glaring	_A Frame RGBW DMX	_I / _IJ Frame Inox	_I Frame Anti-glaring	_I Frame RGBW DMX	PRO_I PRO_I RGBW DMX
11,2 W 13,6 W	371 x 62 mm	371 x 62 mm	375 x 66 mm	375 x 66 mm	375 x 66 mm	-
18,3 W 19,8 W	561 x 62 mm	-	565 x 66 mm	565 x 66 mm	-	-
22 W	-	561 x 62 mm	-	-	565 x 66 mm	-
36,5 W 39,6 W	1051 x 62 mm	-	1055 x 66 mm	1055 x 66 mm	-	-
PRO 37 W						585 x 150 mm
44 W	-	1051 x 62 mm	-	-	1055 x 66 mm	-
PRO 46 W						585 x 150 mm
PRO 74 W						1090 x 150 mm
PRO 80,5 W						1090 x 150 mm
Finish	Anod. Al.	Anod. Al.	Steel	Steel	Steel	Steel
powerLED	2700K - 3000K 4000K	RGBW	2700K - 3000K 4000K	2700K - 3000K 4000K	RGBW	2700K - 3000K - 4000K RGBW
Optics	Spot Flood Wide Flood Elliptic	Spot Flood Wide Flood Elliptic Asymmetric	Spot Narrow Spot Flood Wide Flood Elliptic Asymmetric	Spot Flood Wide Flood Elliptic	Spot Flood Wide Flood Elliptic Asymmetric	Narrow Spot Spot Flood Elliptic
Driver 	On/Off DALI	DMX	On/Off DALI	On/Off DALI	DMX	On/Off DMX

Fabrication de qualité

Le corps d'Archiline est fabriqué par extrusion d'alliage d'aluminium 6060 et est ensuite traité avec une épaisseur anodique de 10 µm.

L'ensemble des 2 procédés garantit une plus grande dissipation thermique passive et surtout une plus grande résistance à la corrosion.

Les bouchons sont obtenus par moulage sous pression.

Nouvelle version à basculement

La ligne Archiline s'agrandit avec la nouvelle version à basculement qui vient compléter une gamme riche en solutions et variantes. Archiline_IJ et Archiline_FJ utilisent un système de basculement qui permet d'orienter le groupe optique à 5°/10°/15° grâce à la molette.

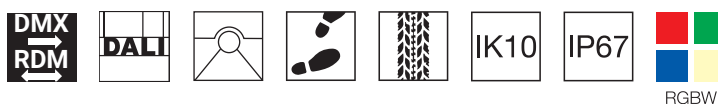
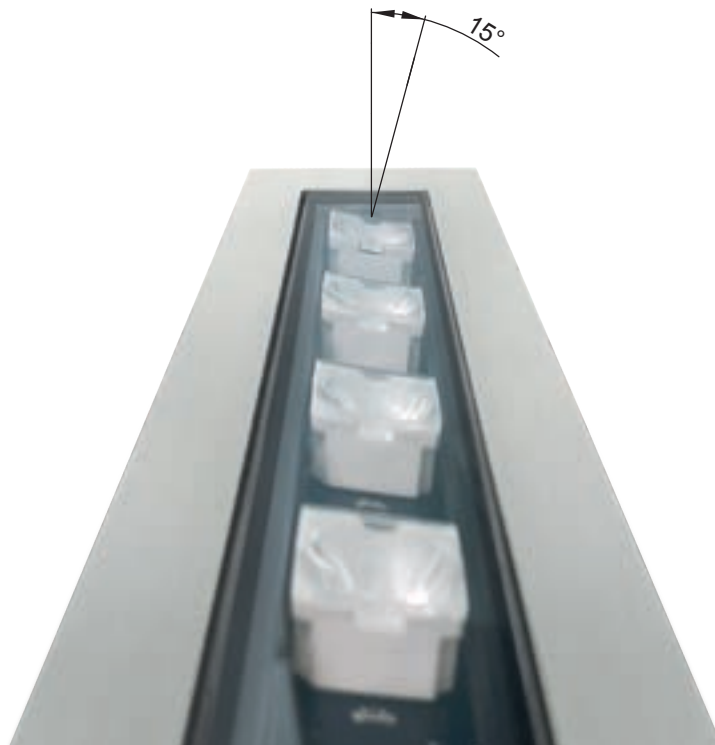

Systèmes de sécurité

Nous avons développé plusieurs systèmes de sécurité spécifiques pour garantir la résistance des luminaires à la corrosion et leur durabilité.

Systèmes de protection contre les surtensions (OVP) et contre les décharges électrostatiques (ESD).

Systèmes de protection de l'intégrité des circuits contre la formation d'humidité (TCS®) et contre la pénétration d'eau (AquaStop®).

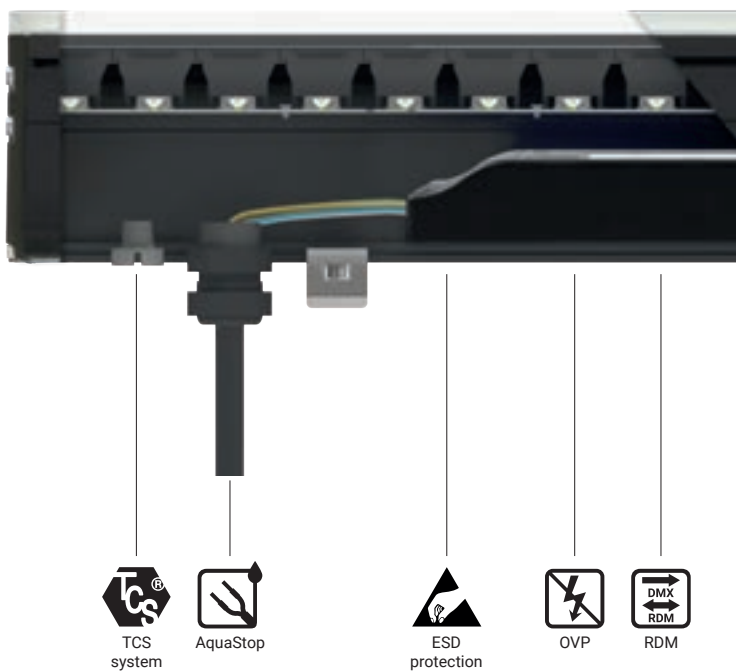

Étendue de la gamme

La gamme Archiline comprend quatre sous-familles de luminaires encastrés.

- ARCHILINE_F : luminaire encastré trimless avec verre trempé extra-clair de 12 mm d'épaisseur et bloc optique sérigraphié noir, avec ou sans darklight ou bien en RGBW ; conçu pour l'éclairage mural (possibilité de créer des lignes continues).

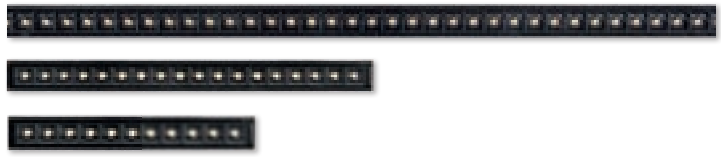

- ARCHILINE_FL : luminaire encastré trimless avec verre trempé de 12 mm d'épaisseur avec peinture céramique blanche, disponible en version monochromatique ou RGBW ; conçu pour l'éclairage des zones de passage (possibilité de créer des lignes continues) dans les parcs, les places, les points d'entrée et les espaces publics.



- ARCHILINE_A : luminaire encastré avec bride en alliage d'aluminium 6060 avec verre trempé extra-clair de 12 mm d'épaisseur et bloc optique sérigraphié noir, avec ou sans darklight ou bien darklight + RGBW ; conçu pour l'éclairage mural.



- ARCHILINE_I : luminaire encastré avec bride en inox AISI316L pour environnements à forte salinité, avec verre trempé extra-clair de 12 mm d'épaisseur et bloc optique sérigraphié noir, avec ou sans darklight ou bien darklight + RGBW ; conçu pour l'éclairage mural.

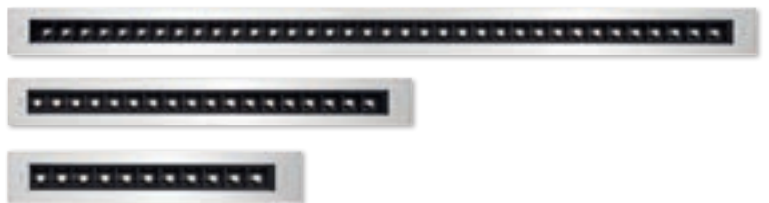

Gamme d'optiques

La famille Archiline propose des optiques pour tous types d'exigences conceptuelles.

- SPOT et NARROW SPOT pour l'éclairage d'accentuation.
- FLOOD et MEDIUM FLOOD pour un éclairage doux de portions de murs.
- ELLIPTIC 20°x50° qui projette un faisceau ovale, idéal pour l'éclairage rasant des murs hauts et étroits.
- ASYMETRIQUE pour un effet lèche-mur sur le mur.

Autres caractéristiques :

- versions avec filtre darklight qui coupe la composante de faisceau dirigée vers l'extérieur pour maintenir un éclairage strictement mural.
- possibilité de créer des lignes continues sans interférence dans l'homogénéité de l'éclairage près des extrémités de chaque module ; dans les versions Archiline_F sans darklight, la disposition des diodes est conçue pour conserver le même espacement entre chaque diode, y compris entre les dernières de chaque extrémité.

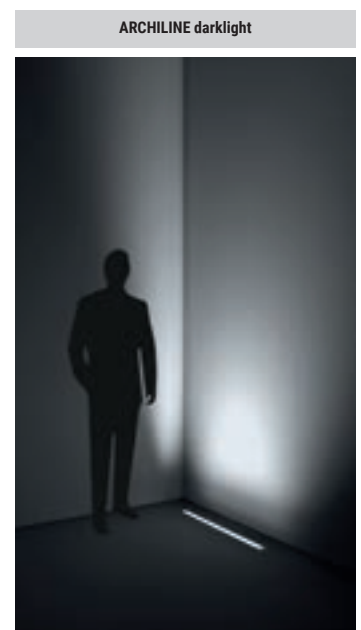

Archiline_F | Linear profiles | 198-264V AC | powerLED

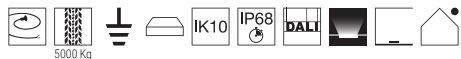

13,2 W DC - 14,5 W AC	Cct	lm S - D	Optic
Anod. Bk. 92127	M 2700	1692 - 916	08 Spot (18°)
DALI 12,2 W DC - 13,5 W AC	W 3000	1812 - 974	15 Spot (23°)
Anod. Bk. 81591	N 4000	1932 - 1037	30 Flood (29°)
			60 W.Flood (53°)
			25 Elliptic -
			27 Asymm. -

6 LEDs

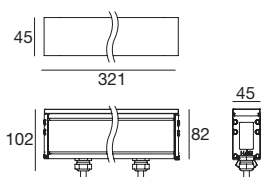

19,8 W DC - 22 W AC	Cct	lm S - D	Optic
Anod. Bk. 92128	M 2700	2538 - 1481	08 Spot (16°)
DALI 18,3 W DC - 20,5 W AC	W 3000	2718 - 1557	15 Spot (18°)
Anod. Bk. 81592	N 4000	2898 - 1658	30 Flood (25°)
			60 W.Flood (57°)
			25 Elliptic -
			27 Asymm. -

9 LEDs

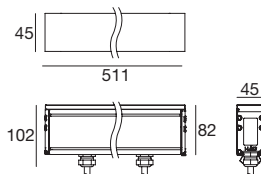

39,6 W DC - 44 W AC	Cct	lm S - D	Optic
Anod. Bk. 92129	M 2700	5076 - 2884	08 Spot (16°)
DALI 36,5 W DC - 41 W AC	W 3000	5436 - 3067	15 Spot (21°)
Anod. Bk. 81593	N 4000	5796 - 3265	30 Flood (28°)
			60 W.Flood (56°)
			25 Elliptic -
			27 Asymm. -

18 LEDs

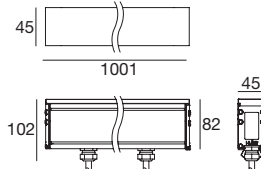

Câbles Pag. 721

Boîtier d'encastrement Pag. 715

Archiline_F Anti-glare | Linear profiles | 198-264V AC | powerLED

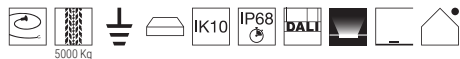

12,1 W DC - 13,5 W AC	Cct	lm S - D	Optic
Anod. Bk. 92049	M 2700	1716 - 645	15 Spot -
DALI 11,2 W DC - 14 W AC	W 3000	1837 - 687	30 Flood -
Anod. Bk. 81594	N 4000	1958 - 730	60 W.Flood -
			25 Elliptic -

11 LEDs

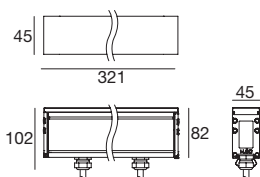

19,8 W DC - 22 W AC	Cct	lm S - D	Optic
Anod. Bk. 92050	M 2700	2808 - 1118	15 Spot -
DALI 18,3 W DC - 20,5 W AC	W 3000	3006 - 1191	30 Flood -
Anod. Bk. 81595	N 4000	3204 - 1264	60 W.Flood -
			25 Elliptic -

18 LEDs

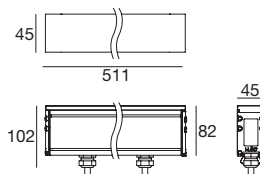

39,6 W DC - 43,5 W AC	Cct	lm S - D	Optic
Anod. Bk. 92051	M 2700	5616 - 2326	15 Spot -
DALI 36,5 W DC - 41 W AC	W 3000	6012 - 2476	30 Flood -
Anod. Bk. 81596	N 4000	6408 - 2628	60 W.Flood -
			25 Elliptic -

36 LEDs

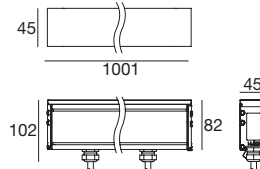

Câbles Pag. 721

Boîtier d'encastrement Pag. 715



13,2 W DC - 14,5 W AC	Cct	lm S - D	Optic
Anod. Bk. 82302	M 2700	1692 - 0n req	08 N.Spot -
DALI 12,2 W DC - 13,5 W AC	W 3000	1812 - 0n req	15 Spot -
Anod. Bk. 82303	N 4000	1932 - 0n req	30 Flood -
			60 W.Flood -
			25 Elliptic -
			27 Asymm. -

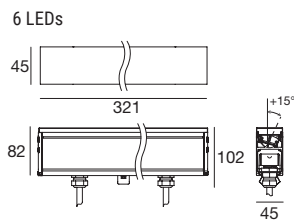

19,8 W DC - 22 W AC	Cct	lm S - D	Optic
Anod. Bk. 82304	M 2700	2538 - 0n req	08 N.Spot -
DALI 18,3 W DC - 20,5 W AC	W 3000	2718 - 0n req	15 Spot -
Anod. Bk. 82305	N 4000	2898 - 0n req	30 Flood -
			60 W.Flood -
			25 Elliptic -
			27 Asymm. -

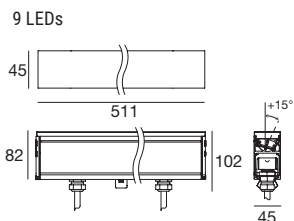

39,6 W DC - 44 W AC	Cct	lm S - D	Optic
Anod. Bk. 82306	M 2700	5076 - 0n req	08 N.Spot -
DALI 36,5 W DC - 41 W AC	W 3000	5436 - 0n req	15 Spot -
Anod. Bk. 82307	N 4000	5796 - 0n req	30 Flood -
			60 W.Flood -
			25 Elliptic -
			27 Asymm. -

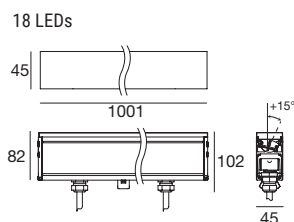

Câbles Pag. 721

Boîtier d'encastrement Pag. 715



13,2 W DC - 14,5 W AC	Optic
Anod. Bk. 92083	Q RGBW natural white
	V RGBW warm white
	15 Spot -
	30 Flood -
	60 W.Flood -
	25 Elliptic -
	27 Asymm. -

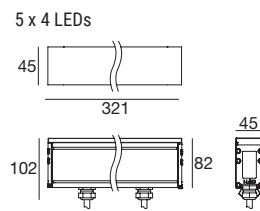

22 W DC - 24,5 W AC	Optic
Anod. Bk. 92084	Q RGBW natural white
	V RGBW warm white
	15 Spot -
	30 Flood -
	60 W.Flood -
	25 Elliptic -
	27 Asymm. -

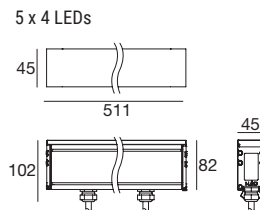

44 W DC - 49 W AC	Optic
Anod. Bk. 92093	Q RGBW natural white
	V RGBW warm white
	15 Spot -
	30 Flood -
	60 W.Flood -
	25 Elliptic -
	27 Asymm. -

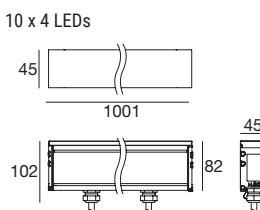

DMX 99385 98986 98985/99390

DMX controllers
Pag. 952 - 953

DMX/RDM
addresser

DMX LINE
Clouser 120 Ohm

Splitter ALLinONE
Start & Continuity
Pag. 956

Câbles Pag. 721

Boîtier d'encastrement Pag. 715

DW Dynamic White on request

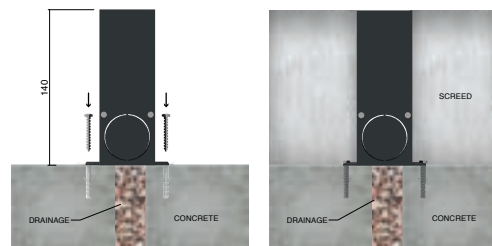

Archiline_FL | Linear profiles | 190-250V AC | topLED



3,6 W DC - 5 W AC	Cct	lm S - D	Optic
Anod. Bk. 92138	W 3000 N 4000	483 - 95 504 - 103	00 General (103°)

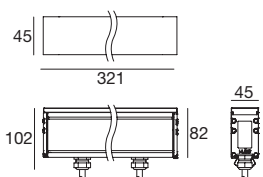

6 W DC - 8,6 W AC	Cct	lm S - D	Optic
Anod. Bk. 92139	W 3000 N 4000	828 - 145 864 - 158	00 General (124°)

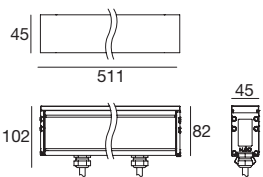

12 W DC - 14,3 W AC	Cct	lm S - D	Optic
Anod. Bk. 92142	W 3000 N 4000	1656 - 290 1728 - 315	00 General (124°)

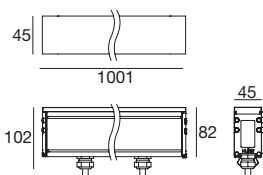

Câbles Pag. 721
Boîtier d'encastrement Pag. 715

Archiline_FL RGBW DMX | Linear profiles | 190-250V AC | topLED



8,4 W DC - 10 W AC	Optic
Anod. Bk. 92143	Q RGBW natural white V RGBW warm white 00 General -

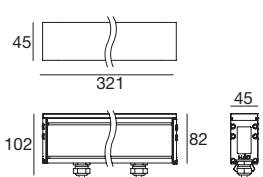

13,6 W DC - 16 W AC	Optic
Anod. Bk. 92144	Q RGBW natural white V RGBW warm white 00 General -

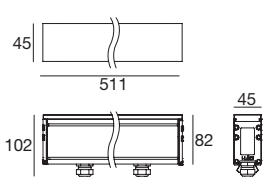

24 W DC - 25 W AC	Optic
Anod. Bk. 92145	Q RGBW natural white V RGBW warm white 00 General -

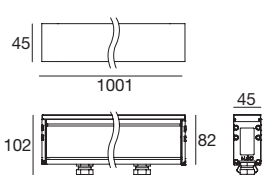

DMX DMX controllers Pag. 952 - 953	99385 DMX/RDM addresser	98986 DMX LINE Clouser 120 Ohm	98985/99390 Splitter ALLinONE Start & Continuity Pag. 956
---	--------------------------------------	---	---

Câbles Pag. 721
Boîtier d'encastrement Pag. 715





13,2 W DC - 14,5 W AC	Cct	lm S - D	Optic
Anod. AL. 92132	M 2700	1692 - 0n req	08 Spot (13°)
DALI 12,2 W DC - 13,5 W AC	W 3000	1812 - 0n req	15 Spot (18°)
Anod. AL. 81603	N 4000	1932 - 0n req	30 Flood (29°)
			60 W.Flood (53°)
			25 Elliptic. -
			27 Asymm. -

6 LEDs

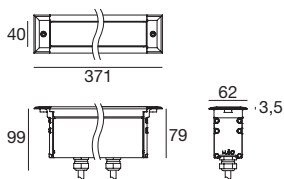

19,8 W DC - 22 W AC	Cct	lm S - D	Optic
Anod. AL. 92134	M 2700	2538 - 0n req	08 Spot (16°)
DALI 18,3 W DC - 20,5 W AC	W 3000	2718 - 0n req	15 Spot (18°)
Anod. AL. 81604	N 4000	2898 - 0n req	30 Flood (25°)
			60 W.Flood (57°)
			25 Elliptic -
			27 Asymm. -

9 LEDs

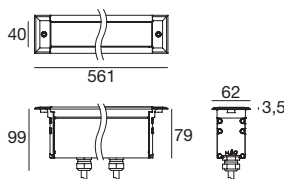

39,6 W DC - 44 W AC	Cct	lm S - D	Optic
Anod. AL. 92136	M 2700	5076 - 0n req	08 Spot (16°)
DALI 36,5 W AC - 41 W AC	W 3000	5436 - 0n req	15 Spot (21°)
Anod. AL. 81605	N 4000	5796 - 0n req	30 Flood (28°)
			60 W.Flood (56°)
			25 Elliptic -
			27 Asymm. -

18 LEDs

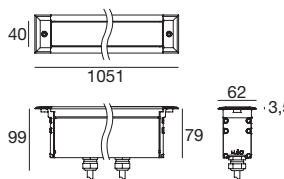

59 W DC - 65 W AC	Cct	lm S - D	Optic
Anod. AL. 81590	M 2700	7182 - 0n req	08 Spot (16°)
DALI 55 W DC - 61,4 W AC	W 3000	7668 - 0n req	15 Spot (21°)
Anod. AL. 81606	N 4000	8181 - 0n req	30 Flood (28°)
			60 W.Flood -
			25 Elliptic -
			27 Asymm. -

27 LEDs

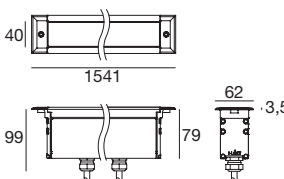

Câbles Pag. 721
Boîtier d'encastrement Pag. 715

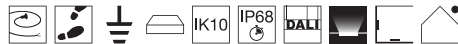

12,1 W DC - 13,5 W AC	Cct	lm S - D	Optic
Anod. AL. 92052	M 2700	1716 - 0n req	15 Spot -
DALI 11,2 W DC - 12,5 W AC	W 3000	1837 - 0n req	30 Flood -
Anod. AL. 81607	N 4000	1958 - 0n req	60 W.Flood -
			25 Elliptic -

11 LEDs

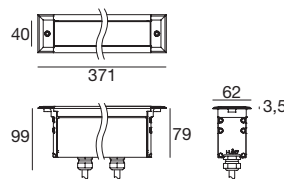

19,8 W DC - 22 W AC	Cct	lm S - D	Optic
Anod. AL. 92054	M 2700	2808 - 0n req	15 Spot -
DALI 18,3 W DC - 20,5 W AC	W 3000	3006 - 0n req	30 Flood -
Anod. AL. 81608	N 4000	3204 - 0n req	60 W.Flood -
			25 Elliptic -

18 LEDs

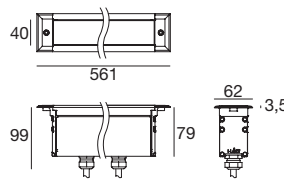

39,6 W DC - 43,5 W AC	Cct	lm S - D	Optic
Anod. AL. 92056	M 2700	5616 - 0n req	15 Spot -
DALI 36,5 W AC - 41 W AC	W 3000	6012 - 0n req	30 Flood -
Anod. AL. 81609	N 4000	6408 - 0n req	60 W.Flood -
			25 Elliptic -

36 LEDs

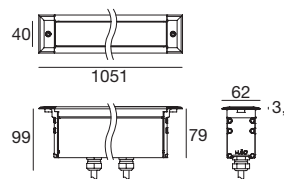

Câbles Pag. 721
Boîtier d'encastrement Pag. 715



13,2 W DC - 14,5 W AC

Anod. AL. **92100**

Q RGBW natural white
V RGBW warm white

Optic

15 Spot	-
30 Flood	-
60 W.Flood	-
25 Elliptic	-
27 Asymm.	-

3 x 4 LEDs

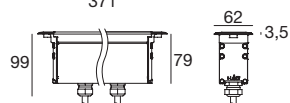
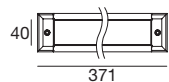

22 W DC - 24,5 W AC

Anod. AL. **92104**

Q RGBW natural white
V RGBW warm white

Optic

15 Spot	-
30 Flood	-
60 W.Flood	-
25 Elliptic	-
27 Asymm.	-

5 x 4 LEDs

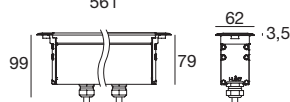

44 W DC - 49 W AC

Anod. AL. **92108**

Q RGBW natural white
V RGBW warm white

Optic

15 Spot	-
30 Flood	-
60 W.Flood	-
25 Elliptic	-
27 Asymm.	-

10 x 4 LEDs

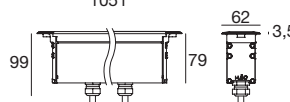
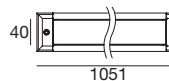

DMX DMX controllers Pag. 952 - 953	99385 DMX/RDM addresser	98986 DMX LINE Clouser 120 Ohm	98985/99390 Splitter ALLinONE Start & Continuity Pag. 956
---	--------------------------------------	---	---

Câbles Pag. 721

Boîtier d'encastrement Pag. 715

DW Dynamic White on request



13,2 W DC - 14,5 W AC	Cct	lm S - D	Optic
Steel 92124	M 2700	1692 - 0n req	08 Spot (19°)
DALI 12,2 W DC - 13,5 W AC	W 3000	1812 - 0n req	15 Flood (23°)
Steel 81597	N 4000	1932 - 0n req	30 Flood (29°)
			60 W.Flood (53°)
			25 Elliptic -
			27 Asymm. -

6 LEDs

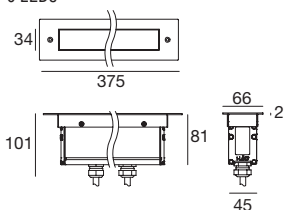

19,8 W DC - 22 W AC	Cct	lm S - D	Optic
Steel 92125	M 2700	2538 - 0n req	08 Spot (16°)
DALI 18,3 W DC - 20,5 W AC	W 3000	2718 - 0n req	15 Spot (18°)
Steel 81598	N 4000	2898 - 0n req	30 Flood (36°)
			60 W.Flood (57°)
			25 Elliptic -
			27 Asymm. -

9 LEDs

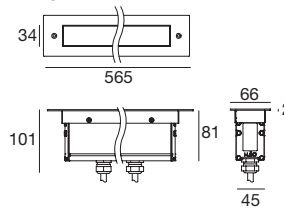

39,6 W DC - 44 W AC	Cct	lm S - D	Optic
Steel 92126	M 2700	5076 - 0n req	08 Spot (16°)
DALI 36,5 W DC - 41 W AC	W 3000	5436 - 0n req	15 Spot (21°)
Steel 81599	N 4000	5796 - 0n req	30 Flood (28°)
			60 W.Flood (56°)
			25 Elliptic -
			27 Asymm. -

18 LEDs

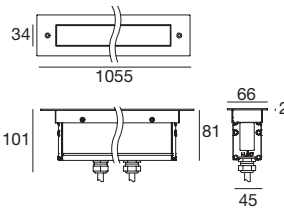

Câbles Pag. 721

Boîtier d'encastrement Pag. 715



12,1 W DC - 13,5 W AC	Cct	lm S - D	Optic
Steel 92046	M 2700	1716 - 0n req	15 Spot -
DALI 11,2 W DC - 12,5 W AC	W 3000	1837 - 0n req	30 Flood -
Steel 81600	N 4000	1958 - 0n req	60 W.Flood -
			25 Elliptic -

11 LEDs

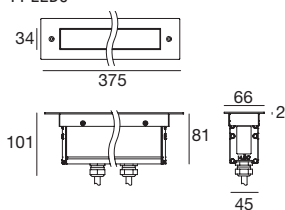

19,8 W DC - 22 W AC	Cct	lm S - D	Optic
Steel 92047	M 2700	2808 - 0n req	15 Spot -
DALI 18,3 W DC - 20,5 W AC	W 3000	3006 - 0n req	30 Flood -
Steel 81601	N 4000	3204 - 0n req	60 W.Flood -
			25 Elliptic -

18 LEDs

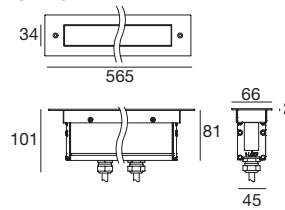

39,6 W DC - 43,5 W AC	Cct	lm S - D	Optic
Steel 92048	M 2700	5616 - 0n req	15 Spot -
DALI 36,5 W DC - 41 W AC	W 3000	6012 - 0n req	30 Flood -
Steel 81602	N 4000	6408 - 0n req	60 W.Flood -
			25 Elliptic -

36 LEDs

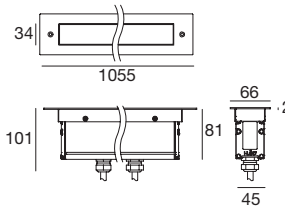

Câbles Pag. 721

Boîtier d'encastrement Pag. 715



13,2 W DC - 14,5 W AC		Cct	lm S - D	Optic
Steel	82308	M 2700	1692 - 0n req	08 N.Spot -
DALI 12,2 W DC - 13,5 W AC		W 3000	1812 - 0n req	15 Spot -
Steel	82309	N 4000	1932 - 0n req	30 Flood -
				60 W.Flood -
				25 Elliptic -
				27 Asymm. -

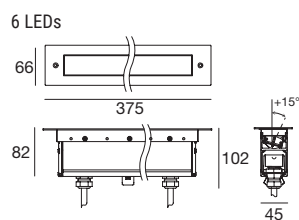

19,8 W DC - 22 W AC		Cct	lm S - D	Optic
Steel	82310	M 2700	2538 - 0n req	08 N.Spot -
DALI 18,3 W DC - 20,5 W AC		W 3000	2718 - 0n req	15 Spot -
Steel	82311	N 4000	2898 - 0n req	30 Flood -
				60 W.Flood -
				25 Elliptic -
				27 Asymm. -

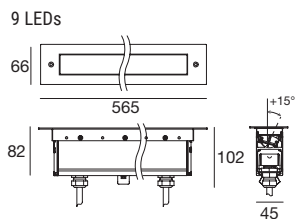

39,6 W DC - 44 W AC		Cct	lm S - D	Optic
Steel	82312	M 2700	5076 - 0n req	08 N.Spot -
DALI 36,5 W DC - 41 W AC		W 3000	5436 - 0n req	15 Spot -
Steel	82313	N 4000	5796 - 0n req	30 Flood -
				60 W.Flood -
				25 Elliptic -
				27 Asymm. -

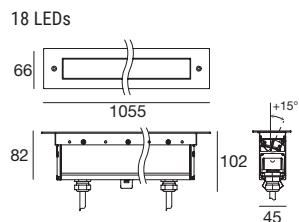

Câbles Pag. 721

Boîtier d'encastrement Pag. 715



13,2 W DC - 14,5 W AC		Optic
Steel	92080	15 Spot -
Q RGBW natural white		30 Flood -
V RGBW warm white		60 W.Flood -
		25 Elliptic -
		27 Asymm. -

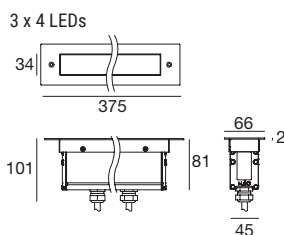

22 W DC - 24,5 W AC		Optic
Steel	92081	15 Spot -
Q RGBW natural white		30 Flood -
V RGBW warm white		60 W.Flood -
		25 Elliptic -
		27 Asymm. -

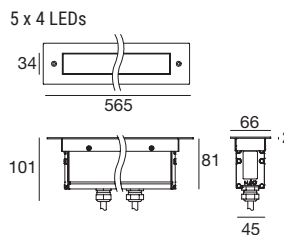

44 W DC - 49 W AC		Optic
Steel	92082	15 Spot -
Q RGBW natural white		30 Flood -
V RGBW warm white		60 W.Flood -
		25 Elliptic -
		27 Asymm. -

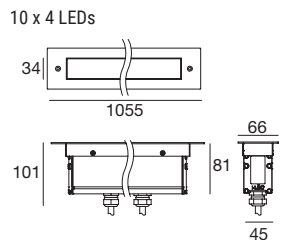

DMX 99385	98986	98985/99390
DMX controllers Pag. 952 - 953	DMX/RDM addresser	DMX LINE Clouser 120 Ohm
		Splitter ALLinONE Start & Continuity Pag. 956

Câbles Pag. 721

Boîtier d'encastrement Pag. 715

DW Dynamic White on request

Archiline PRO_I | Linear profiles | 190-250 V AC | powerLED

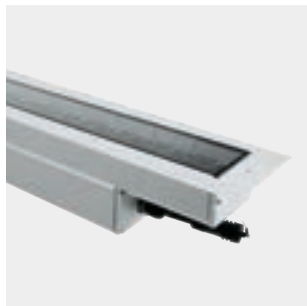

46 W DC - 51 W AC		Cct	lm S - D	Optic
Steel	81673	M 2700	5243 - 3637	15 Spot (23°)
		W 3000	5243 - 3637	30 Flood (28°)
		N 4000	5660 - 3926	25 Elliptic -

46 W DC - 51 W AC		Cct	lm S - D	Optic
Steel	81677	M 2700	5243 - 3948	06 N.Spot -
		W 3000	5243 - 3948	
		N 4000	5660 - 4261	

9 LEDs

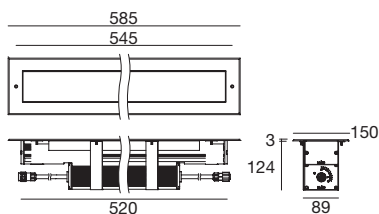

80,5 W DC - 89 W AC		Cct	lm S - D	Optic
Steel	81674	M 2700	10487 - 7174	15 Flood -
		W 3000	10487 - 7174	30 Flood -
		N 4000	11321 - 7743	25 Elliptic -

80,5 W DC - 89 W AC		Cct	lm S - D	Optic
Steel	81678	M 2700	10487 - 6993	06 N.Spot -
		W 3000	10487 - 6993	
		N 4000	11321 - 7560	

18 LEDs

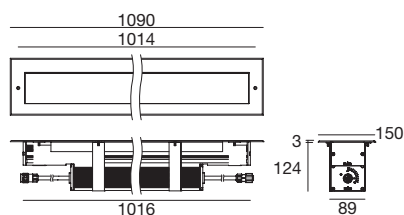

Câbles Pag. 721

Boîtier d'encastrement Pag. 715

Archiline PRO_I RGBW DMX | Linear profiles | 190-250V AC | powerLED



37 W DC - 44 W AC			Optic
Steel	81675	Q RGBW natural white	15 Spot -
		V RGBW warm white	30 Flood -
			45 Flood -
			25 Elliptic -

37 W DC - 44 W AC			Optic
Steel	81679	Q RGBW natural white	06 N.Spot -
		V RGBW warm white	

9 LEDs

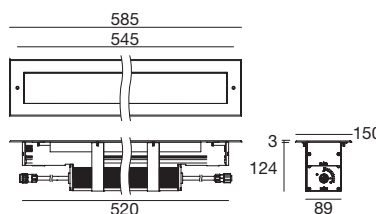

74 W DC - 86 W AC			Optic
Steel	81676	Q RGBW natural white	15 Spot -
		V RGBW warm white	30 Flood -
			45 Flood -
			25 Elliptic -

74 W DC - 86 W AC			Optic
Steel	81680	Q RGBW natural white	06 N.Spot -
		V RGBW warm white	

18 LEDs

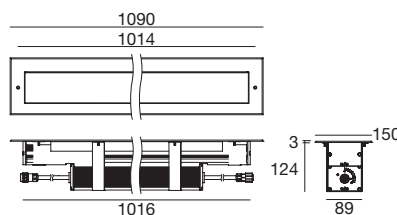

DMX	99385	98986	98985/99390
DMX controllers Pag. 952 - 953	DMX/RDM addresser	DMX LINE Clouser 120 Ohm	Splitter ALLinONE Start & Continuity Pag. 956

Câbles Pag. 721

Boîtier d'encastrement Pag. 715

DW Dynamic White on request

Archiline_F_FJ_FL | Boîtier d'encastrement pour installation encastrée au sol

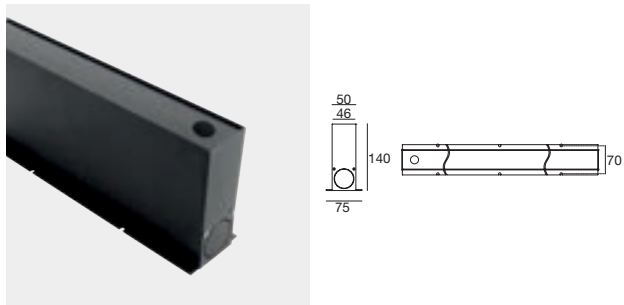

Ces boîtiers encastrables permettent de créer une rangée continue de lumière

98724	Anod. Bk.	322 mm x Archiline_F / _FJ / _FL
98725	Anod. Bk.	513 mm x Archiline_F / _FJ / _FL
98726	Anod. Bk.	1003 mm x Archiline_F / _FJ / _FL

Oxydation anodique

L'anodisation, réalisée dans des conditions électrochimiques contrôlées, crée sur la surface de l'aluminium une couche d'oxyde présentant d'excellentes caractéristiques d'adhérence, de compacité, de dureté et de résistance à la corrosion.

Carrossabilité

Le boîtier d'encastrement des versions Archiline_F, FJ et FL, avec l'aide du verre trempé avec poudres céramiques de 12 mm, garantit une carrossabilité allant jusqu'à 5 tonnes.

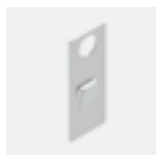
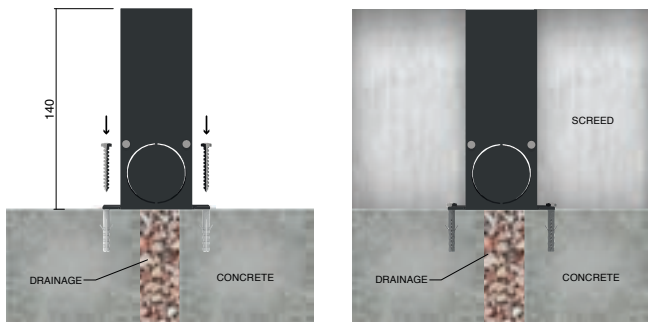

description	
98957	Accessoires

Archiline_A / _I

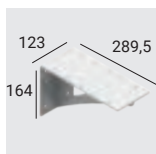

description	
83049	Wall fixing brackets

Linear lights

Archiline_A_I_IJ | Boîtier d'encastrement pour installation encastrée au sol

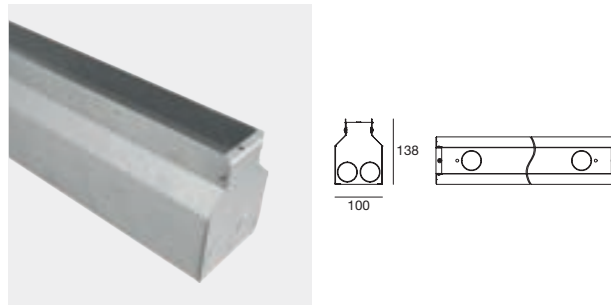

98671	356 mm x Archiline_A / _I / _IJ
98672	546 mm x Archiline_A / _I / _IJ
98673	1036 mm x Archiline_A / _I / _IJ
99760	1526 mm x Archiline_A

Archiline_PRO_I | Boîtier d'encastrement pour installation encastrée au sol

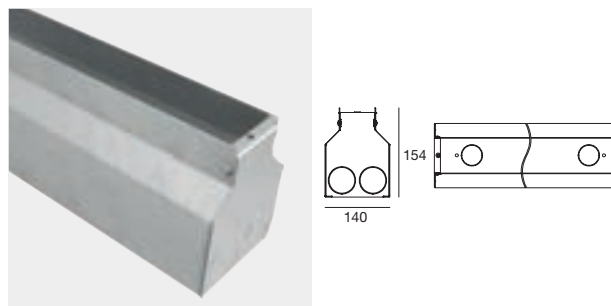

99771	563 mm x Archiline_PRO_I (on request)
99830	1068 mm x Archiline_PRO_I (on request)

Galvanisation

Le boîtier d'encastrement des versions Archiline_A, I, IJ et PRO_I est soumis à un traitement de galvanisation qui confère au produit une meilleure protection contre la corrosion et une meilleure conservation dans le temps.

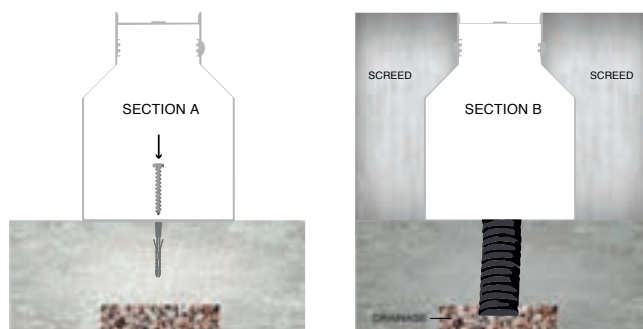



	_W Wall	_W Anti-glare Wall	_W RGBW DMX Wall	PRO_W Anti-glare	PRO_W RGBW DMX Anti-glare
320 mm	12,2 W - 13,2 W	11,2 W - 12,1 W	13,2 W	-	-
356 mm	-	-	-	32 W	24,6 W
515 mm	-	-	-	46 W	37 W
620 mm	22,3 W - 24,3 W	22,4 W - 24,3 W	26,4 W	-	-
920 mm	34,5 W - 37,5 W	33,6 W - 36,4 W	39,6 W	-	-
1016 mm	-	-	-	80,5 W	74 W
1220 mm	44,7 W - 48,5 W	44,8 W - 48,5 W	52,8 W	-	-
1520 mm	55 W - 59 W	-	-	-	-
Finish	Anod. AL	Anod. AL	Anod. AL	Anod. AL	Anod. AL
powerLED	2700K - 3000K 4000K	2700K - 3000K 4000K	RGBW	2700K - 3000K 4000K	RGBW
Optics	Narrow Spot Spot Flood Wide Flood Elliptic Asymmetric	Spot Flood Wide Flood Elliptic	Spot Flood Wide Flood Elliptic Asymmetric	Narrow Spot Spot Flood Wide Flood Elliptic	Narrow Spot Spot Flood Wide Flood Elliptic
Driver 	On/Off DALI	On/Off DALI	DMX	On/Off	DMX

Polyvalence d'applications

Archiline_W est un élément linéaire, conçu pour une installation directe au mur, qui reprend en tous points les fonctions d'un projecteur et les combine avec la forme et la taille d'une barre d'éclairage d'extérieur.

Le corps est fabriqué par extrusion d'alliage d'aluminium 6060 et est ensuite traité avec une épaisseur anodique de 10 µm.

Archiline_W est fourni avec un support gradué en inox orientable pour la fixation au mur ou au plafond, avec distance réglable par rapport au mur.



Mélange parfait

Grâce à la technologie RGBW avec mélange dans l'optique, le mélange des couleurs est meilleur et plus uniforme. Les couleurs sont en effet combinées les unes avec les autres à l'intérieur du bloc optique, grâce à des lentilles spécifiquement traitées et optimisées pour une efficacité maximale et à des LED RGBW toujours plus performantes. Chaque diode regroupe le blanc pur (chaud ou naturel) et les trois couleurs RGB (rouge, vert et bleu) ; cette solution assure un meilleur mélange des couleurs par rapport aux systèmes traditionnels et donne lieu à une variété infinie de nuances chromatiques ainsi qu'à la possibilité d'obtenir un blanc pur sans l'influence des couleurs RGB. Le bloc optique noir sérigraphié avec masquage dark-light permet d'obtenir un contrôle parfait de l'éblouissement en coupant le faisceau lumineux de manière à éliminer la composante directe vers l'extérieur et à maintenir un éclairage strictement mural.

Perfect mixing

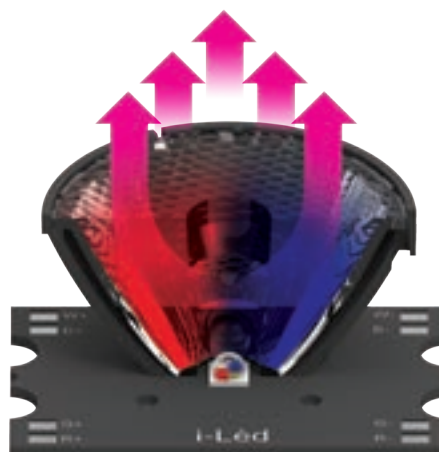

Evolution technique : Archiline_W PRO

La version PRO représente le produit phare de la gamme Archiline. Chaque composant est dédié, y compris les sources avec diodes powerLED alimentées par des drivers intégrés extrêmement performants : Archiline_W PRO atteint une efficacité lumineuse de 100 lm/W, développant ainsi un flux lumineux de plus de 11 000 lumens par mètre ! C'est pour cette raison qu'Archiline_W PRO est fortement recommandé pour l'éclairage des murs particulièrement hauts, grâce notamment au système optique avec diffuseur en verre trempé extra-clair de 5 mm d'épaisseur, à une sérigraphie noire le long des bords, et à des optiques hautement efficaces à faisceau elliptique, étroit ou flood. Les performances d'Archiline dans sa version avec optique à 6 degrés permettent d'orienter le faisceau lumineux de manière à éclairer le mur sur 50 mètres de hauteur ! Disponible en version ON/OFF ou RGBW avec protocole de variation DMX : il est important de souligner que, pour ce modèle, l'alimentation et le signal DMX transitent simultanément par le même connecteur.





13,2 W DC - 14,5 W AC	Cct	lm S - D	Optic
Anod. Al. 92112	M 2700	1692 - 0n req	06 N.Spot -
DALI 12,2 W DC - 13,5 W AC	W 3000	1812 - 974	15 Spot (18°)
Anod. Al. 81610	N 4000	1932 - 1037	30 Flood (29°)

6 LEDs

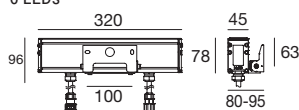

24,3 W DC - 27 W AC	Cct	lm S - D	Optic
Anod. Al. 92114	M 2700	3102 - 0n req	06 N.Spot -
DALI 22,3 W DC - 25 W AC	W 3000	3322 - 0n req	15 Spot (18°)
Anod. Al. 81611	N 4000	3542 - 0n req	30 Flood (25°)

11 LEDs

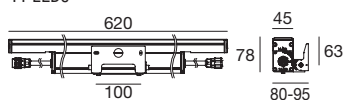

37,5 W DC - 41 W AC	Cct	lm S - D	Optic
Anod. Al. 92118	M 2700	4794 - 0n req	06 N.Spot -
DALI 34,5 W DC - 38,7 W AC	W 3000	5134 - 0n req	15 Spot (22°)
Anod. Al. 81612	N 4000	5474 - 0n req	30 Flood (27°)

17 LEDs

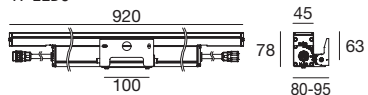

48,5 W DC - 53,5 W AC	Cct	lm S - D	Optic
Anod. Al. 92120	M 2700	6204 - 0n req	06 N.Spot -
DALI 44,7 W DC - 50 W AC	W 3000	6644 - 0n req	15 Spot (22°)
Anod. Al. 81613	N 4000	7084 - 0n req	30 Flood (27°)

22 LEDs

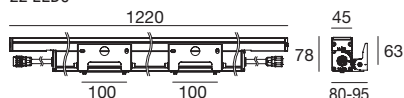

59 W DC - 65 W AC	Cct	lm S - D	Optic
Anod. Al. 81513	M 2700	7448 - 0n req	06 N.Spot -
DALI 55 W DC - 61,5 W AC	W 3000	7952 - 0n req	15 Spot (22°)
Anod. Al. 81614	N 4000	8484 - 0n req	30 Flood (27°)

28 LEDs

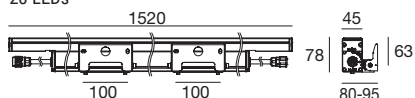

Accessoires et câbles Pag. 721



12,1 W DC - 13,5 W AC	Cct	lm S - D	Optic
Anod. Al. 92038	M 2700	1716 - 0n req	15 Spot -
DALI 11,2 W DC - 12,5 W AC	W 3000	1837 - 0n req	30 Flood -
Anod. Al. 81615	N 4000	1958 - 0n req	60 W.Flood -

11 LEDs

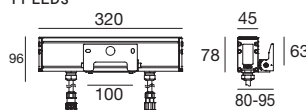

24,3 W DC - 26 W AC	Cct	lm S - D	Optic
Anod. Al. 92040	M 2700	3432 - 0n req	15 Spot -
DALI 22,4 W DC - 25 W AC	W 3000	3674 - 0n req	30 Flood -
Anod. Al. 81616	N 4000	3916 - 0n req	60 W.Flood -

22 LEDs

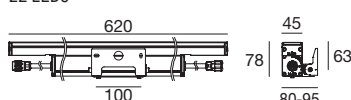

36,4 W DC - 40 W AC	Cct	lm S - D	Optic
Anod. Al. 92042	M 2700	5148 - 0n req	15 Spot -
DALI 33,6 W DC - 37,5 W AC	W 3000	5511 - 0n req	30 Flood -
Anod. Al. 81617	N 4000	5874 - 0n req	60 W.Flood -

33 LEDs

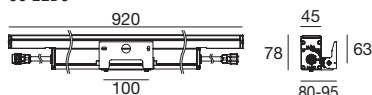

48,5 W DC - 53,5 W AC	Cct	lm S - D	Optic
Anod. Al. 92044	M 2700	6864 - 0n req	15 Spot -
DALI 44,8 W DC - 50 W AC	W 3000	7348 - 0n req	30 Flood -
Anod. Al. 81618	N 4000	7832 - 0n req	60 W.Flood -

44 LEDs

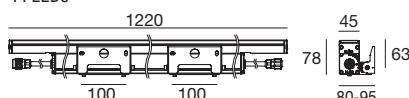

Accessoires et câbles Pag. 721



13,2 W DC - 14,5 W AC

Anod. AL. **92070**

Q RGBW natural white
V RGBW warm white

Optic

15 Spot -
30 Flood -
60 W.Flood -
25 Elliptic -
27 Asymm. -

3 x 4 LEDs

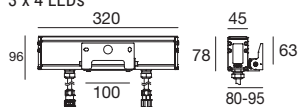

26,4 W DC - 29 W AC

Anod. AL. **92072**

Q RGBW natural white
V RGBW warm white

Optic

15 Spot -
30 Flood -
45 W.Flood -
25 Elliptic -
27 Asymm. -

4 x 6 LEDs

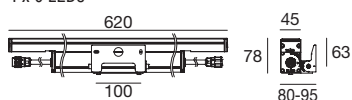

39,6 W DC - 43,5 W AC

Anod. AL. **92074**

Q RGBW natural white
V RGBW warm white

Optic

15 Spot -
30 Flood -
45 W.Flood -
25 Elliptic -
27 Asymm. -

4 x 9 LEDs

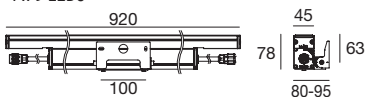

52,8 W DC - 58 W AC

Anod. AL. **92078**

Q RGBW natural white
V RGBW warm white

Optic

15 Spot -
30 Flood -
45 W.Flood -
25 Elliptic -
27 Asymm. -

4 x 12 LEDs

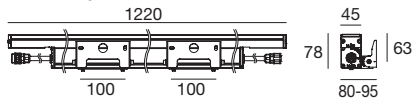

DMX 99385 98986 98985/99390

DMX controllers
Pag. 952 - 953

DMX/RDM
addresser

DMX LINE
Clouser 120 Ohm

Splitter ALLinONE
Start & Continuity
Pag. 956

Accessoires et câbles Pag. 721

DW Dynamic White on request

Archiline PRO_W | Linear profiles | 190-250 V AC | powerLED



32 W DC - 35 W AC	Cct	lm S - D	Optic
Anod. AL. 90458	M 2700	3629 - 2337	15 Spot (16°)
	W 3000	3629 - 2337	30 Flood (27°)
	N 4000	3917 - 2522	25 Elliptic -

32 W DC - 35 W AC	Cct	lm S - D	Optic
Anod. AL. 81447	M 2700	3629 - 2736	06 N.Spot -
	W 3000	3629 - 2736	
	N 4000	3917 - 2952	

6 LEDs

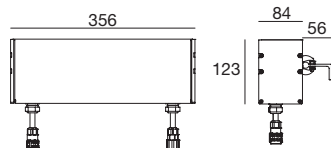

46 W DC - 51 W AC	Cct	lm S - D	Optic
Anod. AL. 90460	M 2700	5234 - 3637	15 Flood (23°)
	W 3000	5243 - 3637	30 Flood (28°)
	N 4000	5660 - 3926	25 W.Flood (47°)

46 W DC - 51 W AC	Cct	lm S - D	Optic
Anod. AL. 81448	M 2700	5234 - 3948	06 N.Spot -
	W 3000	5243 - 3948	
	N 4000	5660 - 4261	

9 LEDs

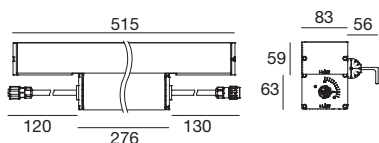

80,5 W DC - 89 W AC	Cct	lm S - D	Optic
Anod. AL. 90461	M 2700	10487 - 7174	15 W.Flood -
	W 3000	10487 - 7174	30 W.Flood -
	N 4000	11321 - 7743	25 Elliptic -

80,5 W DC - 89 W AC	Cct	lm S - D	Optic
Anod. AL. 81449	M 2700	10487 - 6993	06 N.Spot -
	W 3000	10487 - 6993	
	N 4000	11321 - 7560	

18 LEDs

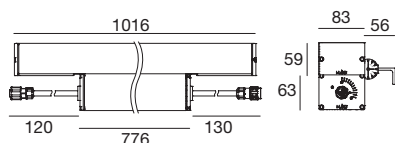

Archiline PRO_W RGBW DMX | Linear profiles | 190-250V AC | powerLED

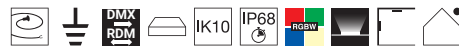

24,6 W DC - 30 W AC		Optic
Anod. AL. 90459	Q RGBW natural white	15 Spot -
	V RGBW warm white	30 Flood -
		45 W.Flood -
		25 Elliptic -

24,6 W DC - 30 W AC		Optic
Anod. AL. 81450	Q RGBW natural white	06 N.Spot -
	V RGBW warm white	

3 x 2 LEDs

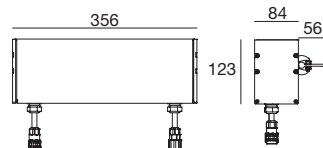

37 W DC - 44 W AC		Optic
Anod. AL. 90462	Q RGBW natural white	15 Spot -
	V RGBW warm white	30 Flood -
		45 W.Flood -
		25 Elliptic -

37 W DC - 44 W AC		Optic
Anod. AL. 81451	Q RGBW natural white	06 N.Spot -
	V RGBW warm white	

3 x 3 LEDs

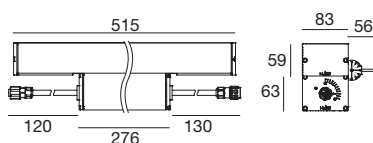

74 W DC - 86 W AC		Optic
Anod. AL. 90463	Q RGBW natural white	15 Spot -
	V RGBW warm white	30 Flood -
		45 W.Flood -
		25 Elliptic -

74 W DC - 86 W AC		Optic
Anod. AL. 81452	Q RGBW natural white	06 N.Spot -
	V RGBW warm white	

3 x 6 LEDs

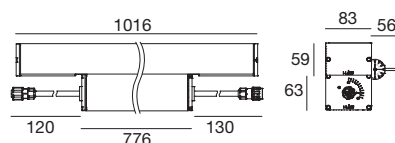

DMX	99385	98986	98985/99390
DMX controllers Pag. 952 - 953	DMX/RDM addresser	DMX LINE Clouser 120 Ohm	Splitter ALLinONE Start & Continuity Pag. 956

Câbles Pag. 721

DW Dynamic White on request

Câbles Pag. 721

Flap

Cet accessoire est constitué de deux ailettes directionnelles conçues pour façonner la lumière lorsque le luminaire est utilisé comme spot. Attention : l'émission lumineuse n'est pas réduite, mais seulement façonnée. Cet accessoire est en aluminium anodisé noir.

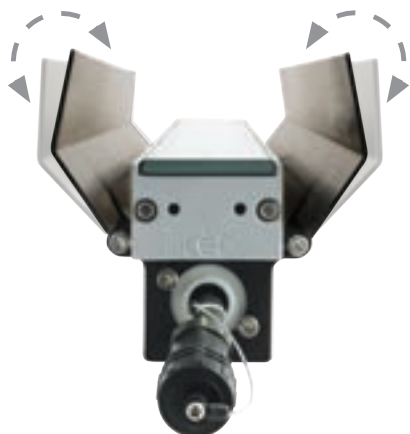

type
Anod.Bk. **98675** suitable for Archiline_W 620 mm

type
Anod.Bk. **98676** suitable for Archiline_W 920 mm

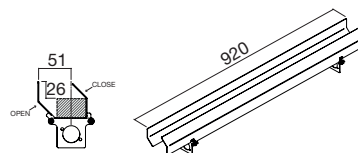
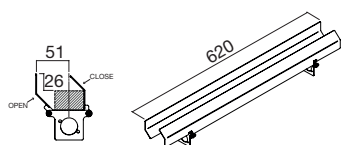

type
Anod.Bk. **98677** suitable for Archiline_W 1220 mm

type
Anod.Bk. **99748** suitable for Archiline_W 1520 mm

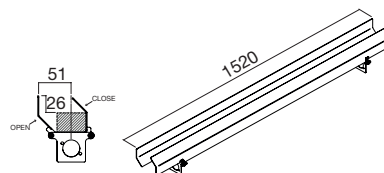
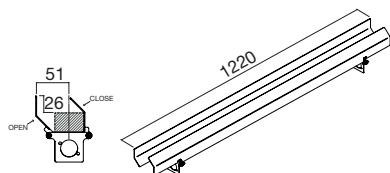

Câbles



On/Off 190-250V AC
99057 Conn. F.3 pin (L 2m)
suitable for: Archiline



DALI 190-250V AC
99826 Conn. F. 5 pin (L 1m)
99822 Conn. F. 5 pin (L 5m)
suitable for: Archiline



AllinOne DMX 190-250V AC
98660 F. 6 pin (L 1m)
98661 F. 6 pin (L 5m)
suitable for: Archiline

Câbles d'extension



On/Off 190-250V AC
98147 Conn. M. / F. 3 pin (L 5m)
98146 Conn. M. / F. 3 pin (L 10m)
suitable for: Archiline



DALI 190-250V AC
99823 Conn. M. / F. 5 pin (L 1m)
99824 Conn. M. / F. 5 pin (L 5m)
99825 Conn. M. / F. 5 pin (L 10m)
suitable for: Archiline



AllinOne DMX 190-250V AC
98662 M. / F. 6 pin (L 1m)
98663 M. / F. 6 pin (L 5m)
suitable for: Archiline

xenia

Matériaux

Corps en alliage d'aluminium 6060 anodisé

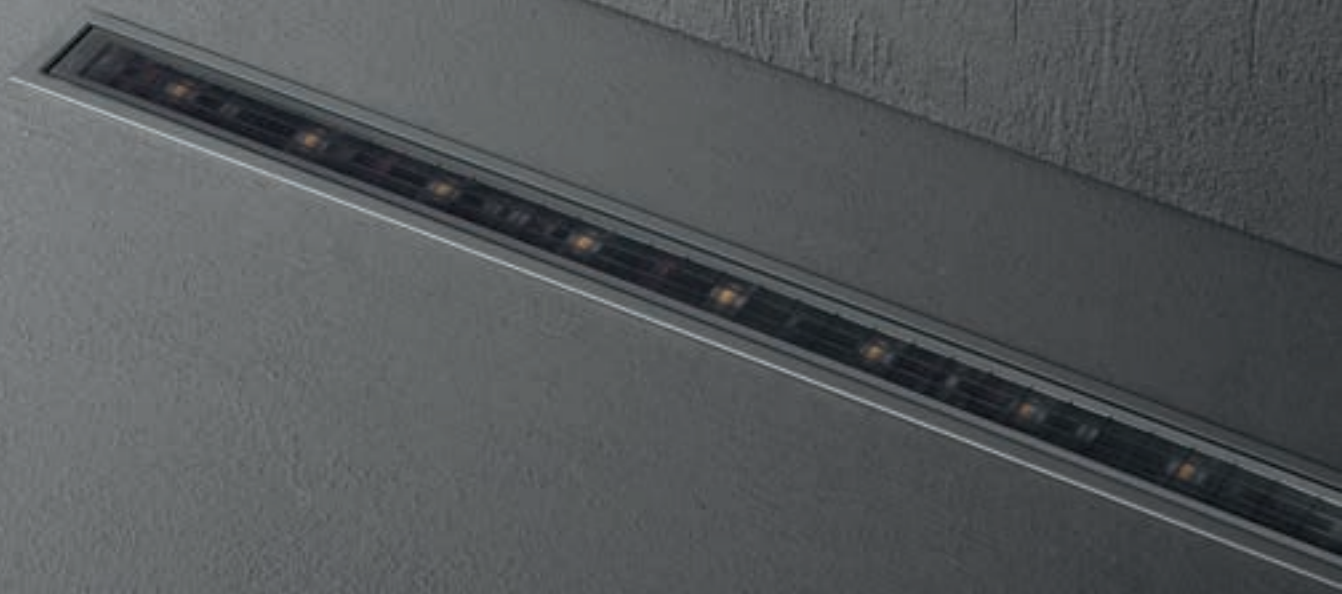



xenia lighting concept

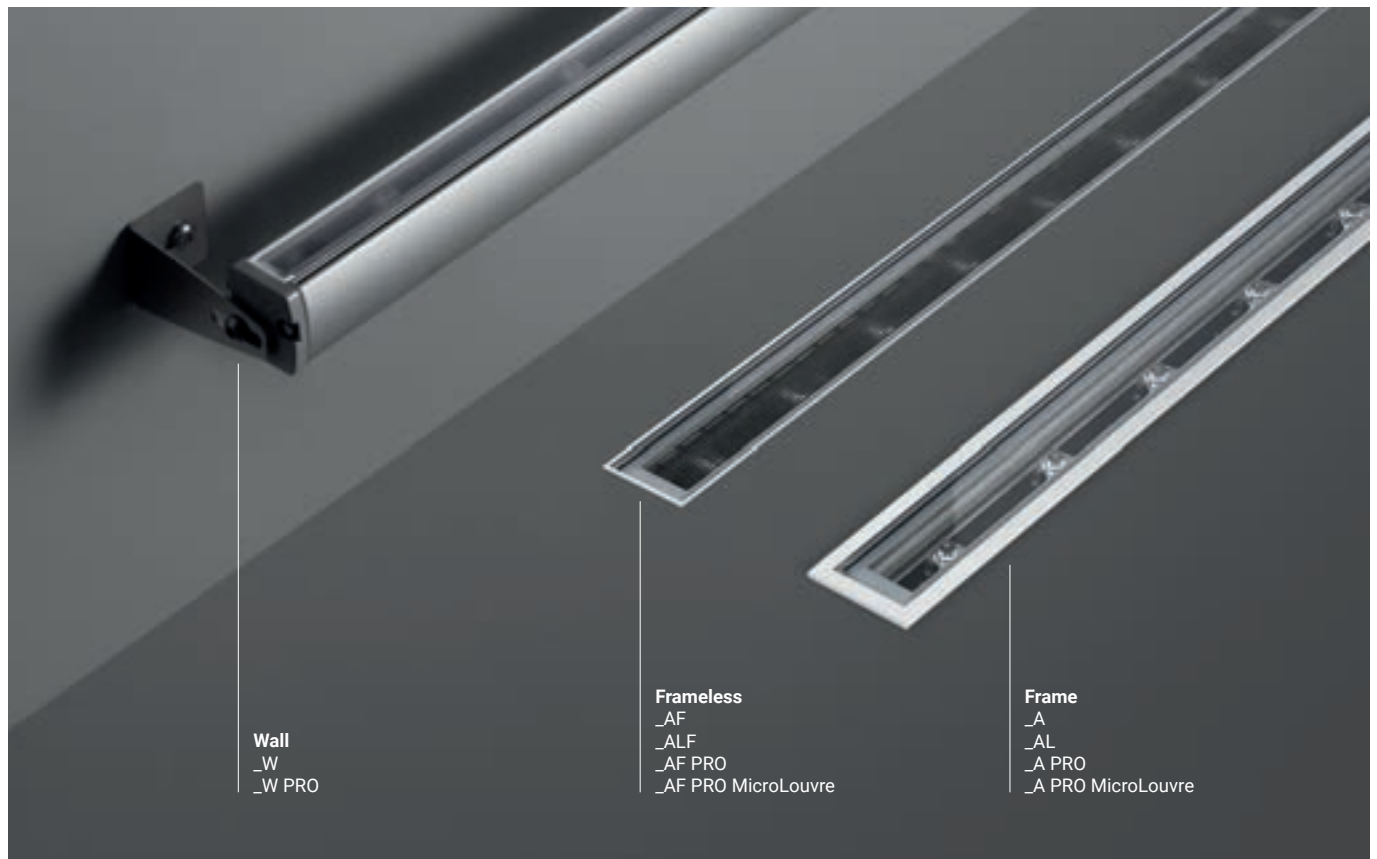

	_W Wall	_W PRO Wall	_A frameless	_AL frame	_A PRO frame	_AF frameless	_ALF frameless	_AF PRO frameless	_A PRO MicroLouvre frame	_AF PRO MicroLouvre frameless
Length	366 -->1530	366 -->1530	359-->1519	359-->1519	160-->1519	359-->1519	359-->1519	160-->1519	359-->1519	359-->1519
topLED	2700K 3000K 4000K RGBW	-	2700K 3000K 4000K RGBW	2700K 3000K 4000K	-	2700K 3000K 4000K RGBW	2700K 3000K 4000K	-	-	-
powerLED	-	2700K 3000K 4000K RGBW	-	-	2700K 3000K 4000K RGBW	-	-	2700K 3000K 4000K RGBW	2700K 3000K 4000K	2700K 3000K 4000K
Optics	Sym. Flood Spot Flood W.Flood E.W.Flood Elliptic Asymm. General	Sym. Flood Flood W.Flood E.W.Flood Elliptic Asymm.	Spot Flood W.Flood E.W.Flood Asymm. General	General	Sym. Flood Spot Flood W.Flood E.W.Flood Elliptic Asymm.	Flood W.Flood E.W.Flood Asymm. General	General	Sym. Flood Flood W.Flood E.W.Flood Elliptic Asymm.	Sym. Flood Flood W.Flood E.W.Flood Elliptic Asymm.	Sym. Flood Flood W.Flood E.W.Flood Elliptic Asymm.
Finish	Anod. AL	Anod. AL	Anod. AL	Anod. AL	Anod. AL	Anod. AL	Anod. AL	Anod. AL	Anod. AL	Anod. AL
Driver ⊗	On/Off 0/1-10V DALI	-	On/Off 0/1-10V DALI	-	On/Off DALI	On/Off 0/1-10V DALI	-	On/Off DALI	-	-
Driver ☐	On/Off DMX	On/Off DALI DMX	On/Off DMX	On/Off	On/Off DALI DMX	On/Off DMX	On/Off	On/Off DALI DMX	On/Off DALI	On/Off DALI

Fabrication de qualité

Le processus de fabrication de Xenia a été étudié pour inclure l'utilisation de matériaux et de composants de la plus haute qualité. En raison de leur type d'installation, ces produits nécessitent une structure solide et résistante, capable de s'adapter à différentes conditions climatiques, allant des températures glaciales (-20 °C) aux températures extrêmement élevées (+ 60 °C), sans altération de performances. Pour obtenir cette résistance élevée à la corrosion, le choix s'est porté sur l'alliage d'aluminium 6060 qui est ensuite traité avec une anodisation anodique de 10 µm d'épaisseur.

Systèmes de sécurité

Nous avons développé plusieurs systèmes de sécurité spécifiques pour garantir la résistance des luminaires à la corrosion et leur durabilité. Systèmes de protection contre les surtensions (OVP) et contre les décharges électrostatiques (ESD). Systèmes de protection de l'intégrité des circuits contre la formation d'humidité (TCS®).

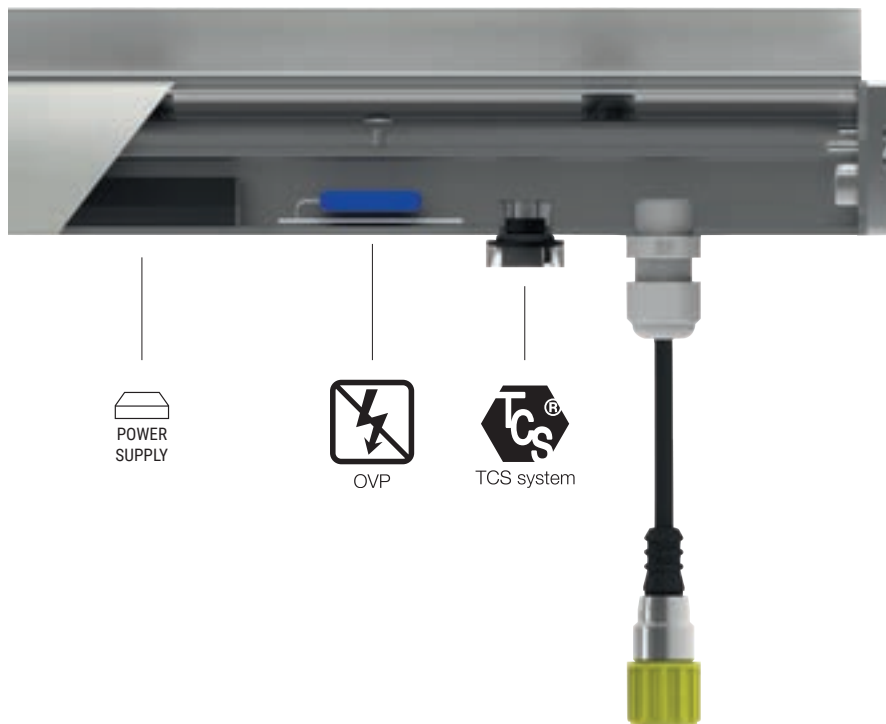

RGBW

MicroLouvre

Xenia_MicroLouvre bénéficie des principales caractéristiques de la gamme Xenia, mais garantit au client un meilleur confort visuel, en appliquant au produit un filet anti-éblouissement, qui sectionne le faisceau en microcellules. Le réticule, extrêmement fin, n'affecte pas la qualité et l'homogénéité de la lumière émise, mais permet de bloquer en partie l'éblouissement.



Versions encastrées

- Installation avec boîtier d'encastrement extra-fin : cadre de seulement 3 mm.
- Possibilité de créer des lignes sans interruption : le profil et le boîtier d'encastrement ne présentent pas de capuchons de fermeture. Cette solution permet de connecter directement plusieurs profils en série pour créer des lignes continues. Une fois la ligne terminée, il est possible d'utiliser les capuchons de fermeture dédiés, conçus pour s'adapter au boîtier d'encastrement en fermant complètement la partie éclairante.
- Accessoire anti-éblouissement (darklight).
- 6 tailles disponibles : de 16 à 150 cm
- Choix d'optiques : Symmetric flood, Flood, Medium flood, Wide flood, Extra wide flood, Asymmetric, General, Narrow spot, Spot, Elliptic.





6,5 W DC	Cct	lm S - D	Optic
Anod. AL 93786	M 2700	699 - 454	20 Flood (26°)
	W 3000	801 - 474	50 Flood (39°)
	N 4000	838 - 482	90 E.W.Flood(66°)
			07 Asymm. -
			00 General (115°)

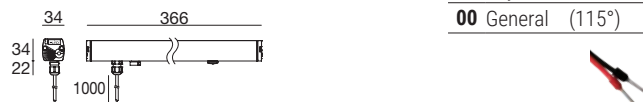

13 W DC	Cct	lm S - D	Optic
Anod. AL 93825	M 2700	1528 - 909	20 Flood (26°)
	W 3000	1602 - 949	50 Flood (39°)
	N 4000	1676 - 964	90 E.W.Flood(66°)
			07 Asymm. -
			00 General (115°)

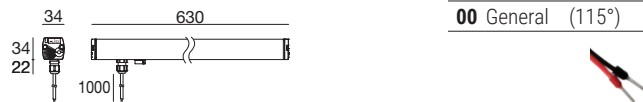

19,5 W DC	Cct	lm S - D	Optic
Anod. AL 93828	M 2700	2292 - 1382	20 Flood (27°)
	W 3000	2403 - 1441	50 Flood (43°)
	N 4000	2514 - 1463	90 E.W.Flood(68°)
			07 Asymm. -
			00 General (115°)

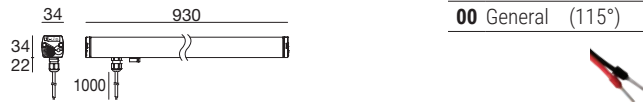

26 W DC	Cct	lm S - D	Optic
Anod. AL 93829	M 2700	3056 - 1834	20 Flood (27°)
	W 3000	3204 - 1922	50 Flood (43°)
	N 4000	3352 - 1950	90 E.W.Flood(68°)
			07 Asymm. -
			00 General (115°)

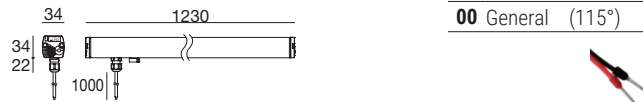

32,5 W DC	Cct	lm S - D	Optic
Anod. AL 81696	M 2700	3820 - 2293	20 Flood (27°)
	W 3000	4005 - 2401	50 Flood (43°)
	N 4000	4190 - 2513	90 E.W.Flood(68°)
			07 Asymm. -
			00 General (115°)



99374	99331	99332	83062	99787
ON/OFF 75 W	ON/OFF 150 W	0/1-10V 150 W	DALI 120 W	DALI 120 W
p 210 x 148 x h 25	p 150 x 160 x h 35	p 150 x 160 x h 35	p 191 x 163 x h 38	p 244 x 171 x h 38

Support de fixation et accessoires Pag. 741/742

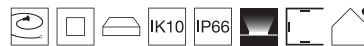

6,5 W DC - 8,2 W AC	Cct	lm S - D	Optic
Anod. AL 93688	M 2700	764 - 454	20 Flood (26°)
	W 3000	801 - 474	50 Flood (39°)
	N 4000	838 - 482	90 E.W.Flood(66°)
			07 Asymm. -
			00 General (115°)

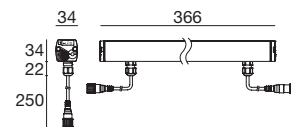

13 W DC - 14,2 W AC	Cct	lm S - D	Optic
Anod. AL 93689	M 2700	1528 - 909	20 Flood (26°)
	W 3000	1602 - 949	50 Flood (39°)
	N 4000	1676 - 964	90 E.W.Flood(66°)
			07 Asymm. -
			00 General (115°)

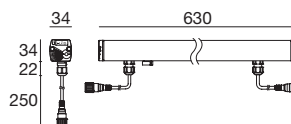

19,5 W DC - 21,4 W AC	Cct	lm S - D	Optic
Anod. AL 94020	M 2700	2292 - 1381	20 Flood (27°)
	W 3000	2403 - 1441	50 Flood (43°)
	N 4000	2514 - 1463	90 E.W.Flood(68°)
			07 Asymm. -
			00 General (115°)

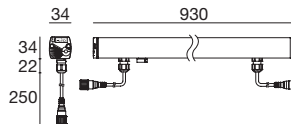

25 W DC - 27,8 W AC	Cct	lm S - D	Optic
Anod. AL 94023	M 2700	3056 - 1834	20 Flood (27°)
	W 3000	3204 - 1922	50 Flood (43°)
	N 4000	3352 - 1950	90 E.W.Flood(68°)
			07 Asymm. -
			00 General (115°)

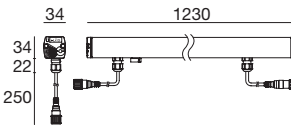

32,5 W DC - 37 W AC	Cct	lm S - D	Optic
Anod. AL 81695	M 2700	3820 - 2293	20 Flood (27°)
	W 3000	4005 - 2401	50 Flood (43°)
	N 4000	4190 - 2513	90 E.W.Flood(68°)
			07 Asymm. -
			00 General (115°)

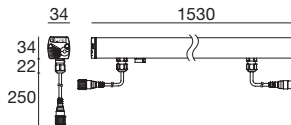

Support de fixation, accessoires et câbles Pag. 741/742

Xenia_W RGBW DMX | Linear profiles | 190-250V AC | topLED



12 W DC - 13 W AC

Anod. AL. **84047**

Q RGBW natural white
V RGBW warm white

Optic

20 Spot -
50 W.Flood -
90 E.W.Flood-
07 Asymm. -
00 General -

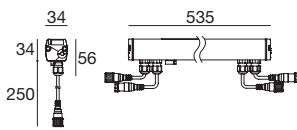

22 W DC - 24 W AC

Anod. AL. **84048**

Q RGBW natural white
V RGBW warm white

Optic

20 Spot -
50 W.Flood -
90 E.W.Flood-
07 Asymm. -
00 General -

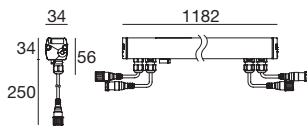

DMX

99385

DMX Controllers
Pag. 952 - 953

89365

DMX/RDM
120 Ohm DMX line
closure

Support de fixation, accessoires et câbles Pag. 741/742



Xenia_W + Anti-éblouissement



6,1 W DC	Cct	lm S - D	Optic
Anod. AL. 93690	M 2700	699 - 0n req	08 Sym. Flood (25°)
	W 3000	747 - 0n req	20 Flood -
	N 4000	798 - 0n req	50 Flood -
			90 E.W.Flood-
			25 Elliptic. -
			07 Asymm. -

3 LEDs

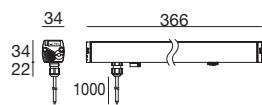

99179	99186	83102
ON/OFF 1 - 2 art.	ON/OFF 2 - 4 art.	DALI 1 - 4 art.
p 80 x l 100 x h 31	p 92 x l 117 x h 38	p 54 x l 121 x h 26

12,1 W DC	Cct	lm S - D	Optic
Anod. AL. 93691	M 2700	1398 - 0n req	08 Sym. Flood(25°)
	W 3000	1494 - 0n req	20 Flood (28°)
	N 4000	1596 - 0n req	50 W.Flood (55°)
			90 E.W.Flood(123°)
			25 Elliptic -
			07 Asymm. -

6 LEDs

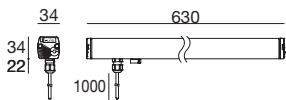

99179	99186	83102
ON/OFF 1 art.	ON/OFF 1 - 2 art.	DALI 1 - 2 art.
p 80 x l 100 x h 31	p 92 x l 117 x h 38	p 54 x l 121 x h 26

17,9 W DC	Cct	lm S - D	Optic
Anod. AL. 93755	M 2700	2097 - 0n req	08 Sym. Flood(24°)
	W 3000	2241 - 0n req	20 Flood (28°)
	N 4000	2394 - 0n req	50 W.Flood (45°)
			90 E.W.Flood(128°)
			25 Elliptic -
			07 Asymm. -

9 LEDs

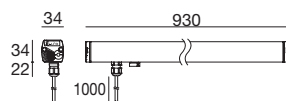

99186	83102
ON/OFF 1 art.	DALI 1 art.
p 92 x l 117 x h 38	p 54 x l 121 x h 26

24,3 W DC	Cct	lm S - D	Optic
Anod. AL. 93785	M 2700	2796 - 0n req	08 Sym. Flood(24°)
	W 3000	2988 - 0n req	20 Flood (30°)
	N 4000	3192 - 0n req	50 W.Flood (46°)
			90 E.W.Flood(136°)
			25 Elliptic -
			07 Asymm. -

12 LEDs

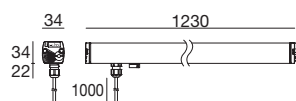

99186	83102
ON/OFF 1 art.	DALI x art.
p 92 x l 117 x h 38	p 54 x l 121 x h 26

Support de fixation et accessoires Pag. 741/742

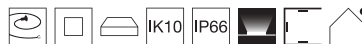

6,1 W DC - 7,8 W AC	Cct	lm S - D	Optic
Anod. AL. 93594	M 2700	699 - 0n req	08 Sym. Flood(25°)
	W 3000	747 - 0n req	20 Flood (28°)
	N 4000	798 - 0n req	50 Flood (44°)
			90 E.W.Flood(115°)
			25 Elliptic -
			07 Asymm. -

3 LEDs

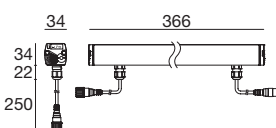

12,1 W DC - 14,2 W AC	Cct	lm S - D	Optic
Anod. AL. 93595	M 2700	1398 - 0n req	08 Sym. Flood(25°)
	W 3000	1494 - 0n req	20 Flood (28°)
	N 4000	1596 - 0n req	50 W.Flood (55°)
			90 E.W.Flood(123°)
			25 Elliptic -
			07 Asymm. -

6 LEDs

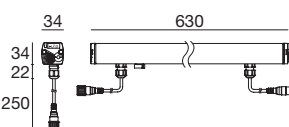

17,9 W DC - 20,4 W AC	Cct	lm S - D	Optic
Anod. AL. 93596	M 2700	2097 - 0n req	08 Sym. Flood(24°)
	W 3000	2241 - 0n req	20 Flood (28°)
	N 4000	2394 - 0n req	50 W.Flood (45°)
			90 E.W.Flood(128°)
			25 Elliptic -
			07 Asymm. -

9 LEDs

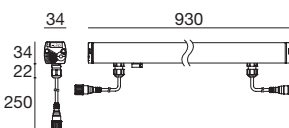

24,3 W DC - 27,2 W AC	Cct	lm S - D	Optic
Anod. AL. 93605	M 2700	2796 - 0n req	08 Sym. Flood(24°)
	W 3000	2988 - 0n req	20 Flood (30°)
	N 4000	3192 - 0n req	50 W.Flood (46°)
			90 E.W.Flood(136°)
			25 Elliptic -
			07 Asymm. -

12 LEDs

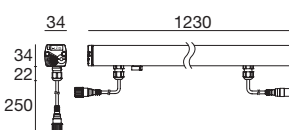

Support de fixation, accessoires et câbles Pag. 741/742

RTG 93596W25

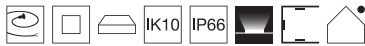

8 W DC - 9 W AC	Cct	lm S - D	Optic
Anod. AL. 81702	M 2700	1086 - 0n req	08 Sym. Flood(23°)
	W 3000	1164 - 0n req	20 Flood (28°)
	N 4000	1242 - 0n req	50 W.Flood (55°)

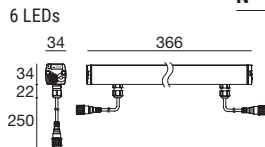

15,1 W DC - 17,1 W AC	Cct	lm S - D	Optic
Anod. AL. 81703	M 2700	2172 - 0n req	08 Sym. Flood(23°)
	W 3000	2328 - 0n req	20 Flood (28°)
	N 4000	2484 - 0n req	50 W.Flood (55°)

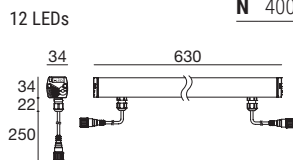

23,1 W DC - 26,2 W AC	Cct	lm S - D	Optic
Anod. AL. 81704	M 2700	3078 - 0n req	08 Sym. Flood(25°)
	W 3000	3294 - 0n req	20 Flood (28°)
	N 4000	3510 - 0n req	50 W.Flood (55°)

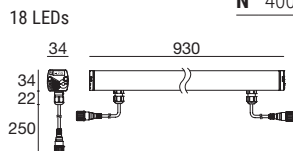

31,8 W DC - 35,4 W AC	Cct	lm S - D	Optic
Anod. AL. 81705	M 2700	4104 - 0n req	08 Sym. Flood(25°)
	W 3000	4392 - 0n req	20 Flood (28°)
	N 4000	4680 - 0n req	50 W.Flood (43°)

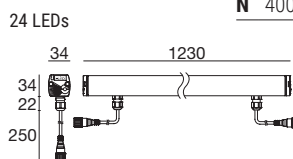

37,4 W DC - 44 W AC	Cct	lm S - D	Optic
Anod. AL. 81706	M 2700	5130 - 0n req	08 Sym. Flood(25°)
	W 3000	5490 - 0n req	20 Flood (28°)
	N 4000	5850 - 0n req	50 W.Flood (43°)

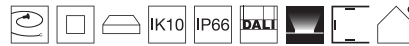
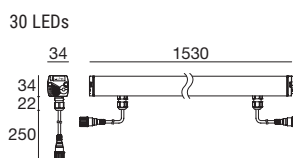

DALI 8,4 W DC - 10,1 W AC	Cct	lm S - D	Optic
Anod. AL. 81713	M 2700	1272 - 0n req	08 Sym. Flood(23°)
	W 3000	1368 - 0n req	20 Flood (28°)
	N 4000	1452 - 0n req	50 W.Flood (55°)

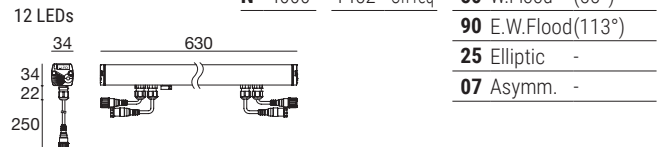

DALI 12,8 W DC - 14,4 W AC	Cct	lm S - D	Optic
Anod. AL. 81714	M 2700	1908 - 0n req	08 Sym. Flood(25°)
	W 3000	2052 - 0n req	20 Flood (28°)
	N 4000	2178 - 0n req	50 W.Flood (55°)

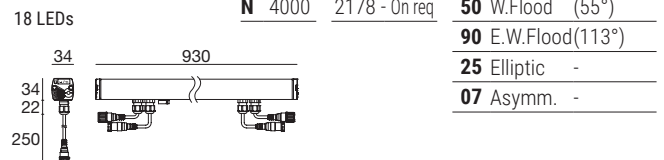

DALI 17,1 W DC - 19,1 W AC	Cct	lm S - D	Optic
Anod. AL. 81715	M 2700	2544 - 0n req	08 Sym. Flood(25°)
	W 3000	2736 - 0n req	20 Flood (28°)
	N 4000	2904 - 0n req	50 W.Flood (43°)

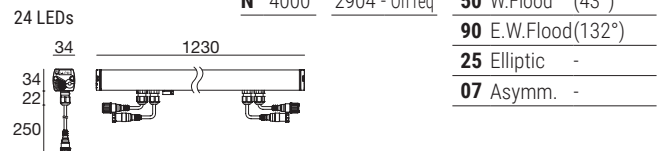

DALI 21,4 W DC - 24 W AC	Cct	lm S - D	Optic
Anod. AL. 81716	M 2700	3180 - 0n req	08 Sym. Flood(25°)
	W 3000	3420 - 0n req	20 Flood (28°)
	N 4000	3630 - 0n req	50 W.Flood (43°)

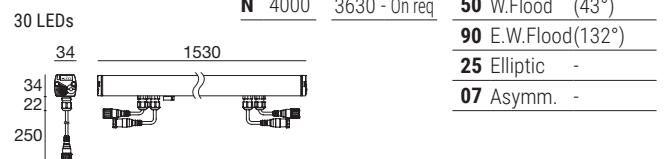

Support de fixation, accessoires et câbles Pag. 741/742

Support de fixation, accessoires et câbles Pag. 741/742



7,3 W DC - 8,5 W AC

Anod. AL **84049**

Q RGBW natural white
V RGBW warm white

Optic

25 Elliptic -

3 x 4 LEDs

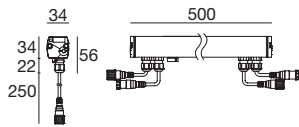

19,3 W DC - 22,6 W AC

Anod. AL **84050**

Q RGBW natural white
V RGBW warm white

Optic

25 Elliptic -

8 x 4 LEDs

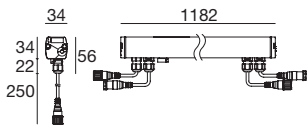

DMX	99385	89365
DMX Controllers Pag. 952 - 953	DMX/RDM	120 Ohm DMX line closure

Support de fixation, accessoires et câbles Pag. 741/742

DW Dynamic White on request



Xenia_A | Linear profiles | 24V DC | topLED



6,5 W DC		Cct	lm S - D	Optic
Anod. AL.	81453	M 2700	764 - 597	20 Flood (27°)
		W 3000	801 - 627	50 Flood (40°)
		N 4000	838 - 656	90 E.W.Flood(80°)
				07 Asymm. -

13 W DC		Cct	lm S - D	Optic
Anod. AL.	81454	M 2700	1528 - 944	20 Flood (27°)
		W 3000	1602 - 988	50 W.Flood (56°)
		N 4000	1676 - 1035	90 E.W.Flood(77°)
				07 Asymm. -

19,5 W DC		Cct	lm S - D	Optic
Anod. AL.	81455	M 2700	2292 - 1401	20 Flood (27°)
		W 3000	2403 - 1468	50 W.Flood (55°)
		N 4000	2514 - 1536	90 E.W.Flood(76°)
				07 Asymm. -

26 W DC		Cct	lm S - D	Optic
Anod. AL.	81456	M 2700	3056 - 1864	20 Flood (29°)
		W 3000	3204 - 1956	50 W.Flood (55°)
		N 4000	3352 - 2044	90 E.W.Flood(76°)
				07 Asymm. -

32,5 W DC		Cct	lm S - D	Optic
Anod. AL.	81621	M 2700	3820 - 2215	20 Flood (31°)
		W 3000	4005 - 2322	50 W.Flood (40°)
		N 4000	4190 - 2429	90 E.W.Flood(70°)
				07 Asymm. -

99374	99331	99332	83062	99787
ON/OFF 75 W p 210 x 148 x h 25	ON/OFF 150 W p 150 x 160 x h 35	0/1-10V 150 W p 150 x 160 x h 35	DALI 120 W p 191 x 163 x h 38	DALI 120 W p 244 x 171 x h 38

Boîtier d'encastrement, accessoires et câbles Pag. 741/742

Xenia_A | Linear profiles | 190-250V AC | topLED



6,5 W DC - 7,15 W AC		Cct	lm S - D	Optic
Anod. AL.	81457	M 2700	764 - On req	20 Flood -
		W 3000	801 - On req	50 W.Flood -
		N 4000	838 - On req	90 E.W.Flood-
				07 Asymm. -

13 W DC - 14,3 W AC		Cct	lm S - D	Optic
Anod. AL.	81458	M 2700	1528 - 944	20 Flood (27°)
		W 3000	1602 - 988	50 W.Flood (56°)
		N 4000	1676 - 1035	90 E.W.Flood(77°)
				07 Asymm. -

19,5 W DC - 21,5 W AC		Cct	lm S - D	Optic
Anod. AL.	81459	M 2700	2292 - 1401	20 Flood (27°)
		W 3000	2403 - 1468	50 W.Flood (55°)
		N 4000	2514 - 1536	90 E.W.Flood(76°)
				07 Asymm. -

26 W DC - 28,6 W AC		Cct	lm S - D	Optic
Anod. AL.	81460	M 2700	3056 - 1864	20 Flood (27°)
		W 3000	3204 - 1955	50 W.Flood (55°)
		N 4000	3352 - 2044	90 E.W.Flood(76°)
				07 Asymm. -

32,5 W DC - 35,8 W AC		Cct	lm S - D	Optic
Anod. AL.	81622	M 2700	3820 - 2215	20 Flood (31°)
		W 3000	4005 - 2322	50 Flood (40°)
		N 4000	4190 - 2429	90 E.W.Flood(70°)
				07 Asymm. -

Boîtier d'encastrement, accessoires et câbles Pag. 741/742

Xenia_AL | Linear profiles | 190-250V AC | topLED



2 W DC - 3 W AC	Cct	lm S - D	Optic
Anod. AL. 81461	M 2700	336 - 78	00 General (108°)
	W 3000	348 - 80	
	N 4000	367 - 85	

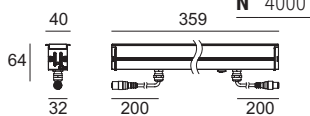

3,6 W DC - 5 W AC	Cct	lm S - D	Optic
Anod. AL. 81462	M 2700	605 - 161	00 General (105°)
	W 3000	626 - 167	
	N 4000	661 - 176	

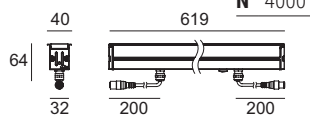

5,4 W DC - 7 W AC	Cct	lm S - D	Optic
Anod. AL. 81463	M 2700	907 - 241	00 General (105°)
	W 3000	939 - 249	
	N 4000	992 - 263	

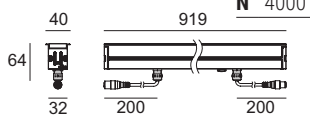

7,2 W DC - 9,4 W AC	Cct	lm S - D	Optic
Anod. AL. 81464	M 2700	1210 - 320	00 General (94°)
	W 3000	1252 - 332	
	N 4000	1322 - 350	

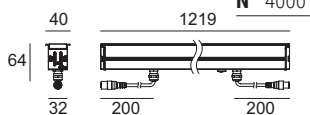

9 W DC - 11,3 W AC	Cct	lm S - D	Optic
Anod. AL. 81623	M 2700	1513 - 401	00 General (94°)
	W 3000	1565 - 415	
	N 4000	1653 - 438	

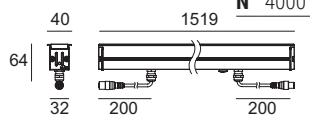

Boîtier d'encastrement, accessoires et câbles Pag. 741/742

Xenia_A RGBW DMX | Linear profiles | 100-240V AC | topLED



12 W DC - 13 W AC	Q	V	Optic
Anod. AL. 84051	Q RGBW natural white	V RGBW warm white	20 Spot -
			50 W.Flood -
			90 E.W.Flood-
			07 Asymm. -
			00 General -

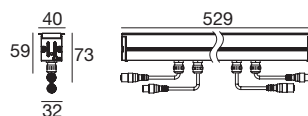

22 W DC - 24 W AC	Q	V	Optic
Anod. AL. 84052	Q RGBW natural white	V RGBW warm white	20 Spot -
			50 W.Flood -
			90 E.W.Flood-
			07 Asymm. -
			00 General -

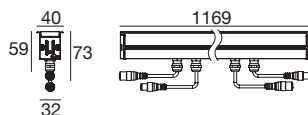

DMX 99385 89365
 DMX Controllers Pag. 952 - 953 DMX/RDM 120 Ohm DMX line closure

Xenia_A PRO | Linear profiles | powerLED 4,5 W DC 500 mA



4,5 W DC	Cct	lm S - D	Optic
Anod. AL. 82711	M 2700	561 - On req	08 Sym. Flood-
	W 3000	597 - On req	20 Spot -
	N 4000	639 - On req	50 W.Flood -
			90 E.W.Flood-
			25 Elliptic -
			07 Asymm. -

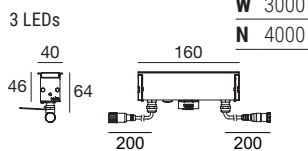

99181 99185 83101
 ON/OFF 1 - 2 art. p 78 x l 100 x h 31 ON/OFF 2 - 4 art. p 92 x l 117 x h 38 DALI 1 - 4 art. p 53 x l 121 x h 26

Boîtier d'encastrement, accessoires et câbles Pag. 741/742



7,4 W DC - 8,3 W AC		Cct	lm S - D	Optic
Anod. AL	81465	M 2700	1086 - 0n req	08 Sym. Flood(24°)
		W 3000	1164 - 0n req	20 Flood (29°)
		N 4000	1242 - 0n req	50 W.Flood (44°)
6 LEDs				90 E.W.Flood(82°)
				25 Elliptic -
				07 Asymm. -
40	359			
64				
32	200			

14,8 W DC - 16,5 W AC		Cct	lm S - D	Optic
Anod. AL	81466	M 2700	2172 - 0n req	08 Sym. Flood(22°)
		W 3000	2328 - 0n req	20 Flood (31°)
		N 4000	2484 - 0n req	50 W.Flood (44°)
12 LEDs				90 E.W.Flood(80°)
				25 Elliptic -
				07 Asymm. -
40	619			
61				
32	200			

22,2 W DC - 24,8 W AC		Cct	lm S - D	Optic
Anod. AL	81467	M 2700	3078 - 0n req	08 Sym. Flood(22°)
		W 3000	3294 - 0n req	20 Flood (29°)
		N 4000	3510 - 0n req	50 W.Flood (45°)
18 LEDs				90 E.W.Flood(122°)
				25 Elliptic -
				07 Asymm. -
40	919			
61				
32	200			

29,6 W DC - 33,2 W AC		Cct	lm S - D	Optic
Anod. AL	81468	M 2700	4104 - 0n req	08 Sym. Flood(22°)
		W 3000	4392 - 0n req	20 Flood (29°)
		N 4000	4680 - 0n req	50 W.Flood (45°)
24 LEDs				90 E.W.Flood(122°)
				25 Elliptic -
				07 Asymm. -
40	1219			
61				
32	200			

37 W DC - 44,3 W AC		Cct	lm S - D	Optic
Anod. AL	81624	M 2700	5130 - 0n req	08 Sym. Flood(23°)
		W 3000	5490 - 0n req	20 Flood (30°)
		N 4000	5850 - 0n req	50 W.Flood (43°)
30 LEDs				90 E.W.Flood(144°)
				25 Elliptic -
				07 Asymm. -
40	1519			
61				
32	200			

Boîtier d'encastrement, accessoires et câbles Pag. 741/742



DALI 8,4 W DC - 10,1 W AC		Cct	lm S - D	Optic
Anod. AL	81687	M 2700	1272 - 0n req	08 Sym. Flood(22°)
		W 3000	1368 - 0n req	20 Flood (31°)
		N 4000	1452 - 0n req	50 Flood (44°)
12 LEDs				90 E.W.Flood(80°)
				25 Elliptic -
				07 Asymm. -
40	619			
61				
32	200			

DALI 12,8 W DC - 14,4 W AC		Cct	lm S - D	Optic
Anod. AL	81688	M 2700	1908 - 0n req	08 Sym. Flood(22°)
		W 3000	2052 - 0n req	20 Flood (29°)
		N 4000	2178 - 0n req	50 W.Flood (45°)
18 LEDs				90 E.W.Flood(122°)
				25 Elliptic -
				07 Asymm. -
40	919			
61				
32	200			

DALI 17,1 W DC - 19,1 W AC		Cct	lm S - D	Optic
Anod. AL	81689	M 2700	2544 - 0n req	08 Sym. Flood(22°)
		W 3000	2736 - 0n req	20 Flood (29°)
		N 4000	2904 - 0n req	50 W.Flood (45°)
24 LEDs				90 E.W.Flood(122°)
				25 Elliptic -
				07 Asymm. -
40	1219			
61				
32	200			

DALI 21,4 W DC - 24 W AC		Cct	lm S - D	Optic
Anod. AL	81690	M 2700	3180 - 0n req	08 Sym. Flood(23°)
		W 3000	3420 - 0n req	20 Flood (30°)
		N 4000	3630 - 0n req	50 Flood (43°)
30 LEDs				90 W.Flood (77°)
				25 Elliptic -
				07 Asymm. -
40	1519			
61				
32	200			

Boîtier d'encastrement, accessoires et câbles Pag. 741/742

Xenia_A PRO RGBW DMX | Linear profiles | 100-240V AC | powerLED



7,3 W DC - 8,5 W AC

Anod. AL.	84053	Q	RGBW natural white	25	Elliptic	-
		V	RGBW warm white			

3 x 4 LEDs

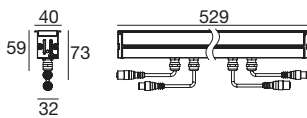

19,3 W DC - 22,6 W AC

Anod. AL.	84054	Q	RGB	25	Elliptic	-
		V	RGBW warm white			

8 x 4 LEDs

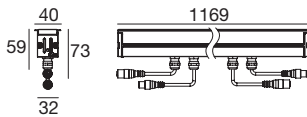

DMX	99385	89365
DMX Controllers Pag. 952 - 953	DMX/RDM	120 Ohm DMX line closure

Boîtier d'encastrement, accessoires et câbles Pag. 741/742

DW Dynamic White on request

Xenia_AF | Linear profiles | 24V DC | topLED



6,5 W DC

Anod. AL.	82491	M	2700	764	- On req	20	Flood	-
		W	3000		801 - On req		50	Flood
		N	4000		838 - On req		90	E.W.Flood-

12 LEDs

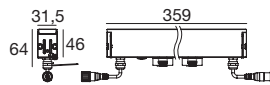

13 W DC

Anod. AL.	82492	M	2700	1528	- On req	20	Flood	-
		W	3000		1602 - On req		50	W.Flood
		N	4000		1676 - On req		90	E.W.Flood-

12 LEDs

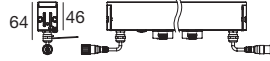

19,5 W DC

Anod. AL.	82493	M	2700	2292	- On req	20	Flood	-
		W	3000		2403 - On req		50	W.Flood
		N	4000		2514 - On req		90	E.W.Flood-

12 LEDs

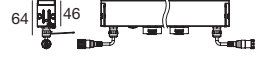

26 W DC

Anod. AL.	82494	M	2700	3056	- On req	20	Flood	-
		W	3000		3204 - On req		50	W.Flood
		N	4000		3352 - On req		90	E.W.Flood-

12 LEDs

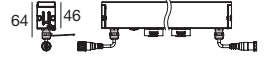

32,5 W DC

Anod. AL.	82495	M	2700	3820	- On req	20	Flood	-
		W	3000		4005 - On req		50	W.Flood
		N	4000		4190 - On req		90	E.W.Flood-

12 LEDs

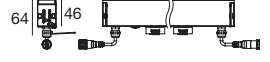

99374	99331	99332	83062	99787
ON/OFF 75 W	ON/OFF 150 W	0/1-10V 150 W	DALI 120 W	DALI 120 W
p 210 x l 48 x h 25	p 150 x l 60 x h 35	p 150 x l 60 x h 35	p 191 x l 63 x h 38	p 244 x l 71 x h 38

Boîtier d'encastrement, accessoires et câbles Pag. 741/742

Xenia_AF | Linear profiles | 190-250V AC | topLED



6,5 W DC - 7,2 W AC	Cct	lm S - D	Optic
Anod. AL. 82486	M 2700	764 - 0n req	20 Flood -
	W 3000	801 - 0n req	50 W.Flood -
	N 4000	838 - 0n req	90 E.W.Flood-
12 LEDs			07 Asymm. -

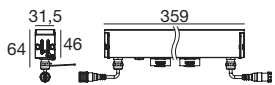

13 W DC - 14,3 W AC	Cct	lm S - D	Optic
Anod. AL. 82487	M 2700	1528 - 0n req	20 Flood -
	W 3000	1602 - 0n req	50 W.Flood -
	N 4000	1676 - 0n req	90 E.W.Flood-
			07 Asymm. -

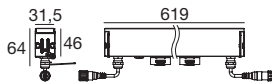

19,5 W DC - 21,5 W AC	Cct	lm S - D	Optic
Anod. AL. 82488	M 2700	2292 - 0n req	20 Flood -
	W 3000	2403 - 0n req	50 W.Flood -
	N 4000	2514 - 0n req	90 E.W.Flood-
			07 Asymm. -

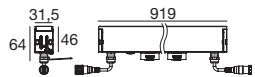

26 W DC - 28,6 W AC	Cct	lm S - D	Optic
Anod. AL. 82489	M 2700	3056 - 0n req	20 Flood -
	W 3000	3204 - 0n req	50 W.Flood -
	N 4000	3352 - 0n req	90 E.W.Flood-
			07 Asymm. -

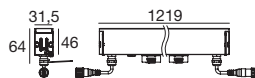

32,5 W DC - 35,8 W AC	Cct	lm S - D	Optic
Anod. AL. 82490	M 2700	3820 - 0n req	20 Flood -
	W 3000	4005 - 0n req	50 Flood -
	N 4000	4190 - 0n req	90 E.W.Flood-
			07 Asymm. -

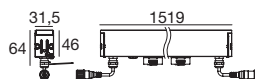

Support de fixation, boîtier d'encastrement, accessoires et câbles Pag. 741/742

Xenia_ALF | Linear profiles | 190-250V AC | topLED



2 W DC - 3 W AC	Cct	lm S - D	Optic
Anod. AL. 82481	M 2700	336 - 0n req	00 General -
	W 3000	348 - 0n req	
	N 4000	367 - 0n req	

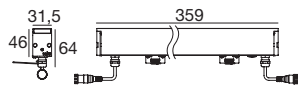

3,6 W DC - 5 W AC	Cct	lm S - D	Optic
Anod. AL. 82482	M 2700	605 - 0n req	00 General -
	W 3000	626 - 0n req	
	N 4000	661 - 0n req	

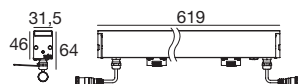

5,4 W DC - 7 W AC	Cct	lm S - D	Optic
Anod. AL. 82483	M 2700	907 - 0n req	00 General -
	W 3000	939 - 0n req	
	N 4000	992 - 0n req	

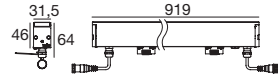

7,2 W DC - 9,4 W AC	Cct	lm S - D	Optic
Anod. AL. 82484	M 2700	1210 - 0n req	00 General -
	W 3000	1252 - 0n req	
	N 4000	1322 - 0n req	

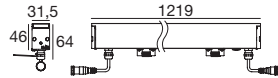

9 W DC - 11,3 W AC	Cct	lm S - D	Optic
Anod. AL. 82485	M 2700	1513 - 0n req	00 General -
	W 3000	1565 - 0n req	
	N 4000	1653 - 0n req	

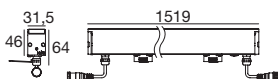

Support de fixation, boîtier d'encastrement, accessoires et câbles Pag. 741/742

Xenia_AF RGBW DMX | Linear profiles | 100-240V AC | topLED



12 W DC - 13 W AC

Anod. AL.	83589	Q RGBW natural white
		V RGBW warm white

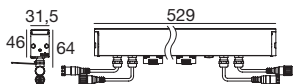

Optic

20 Spot	-
50 W.Flood	-
90 E.W.Flood-	-
07 Asymm.	-
00 General	-

22 W DC - 24 W AC

Anod. AL.	83590	Q RGBW natural white
		V RGBW warm white

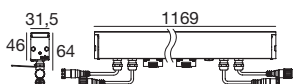

Optic

20 Spot	-
50 W.Flood	-
90 E.W.Flood-	-
07 Asymm.	-
00 General	-

DMX 99385 89365
 DMX Controllers Pag. 952 - 953 DMX/RDM 120 Ohm DMX line closure

Support de fixation, boîtier d'encastrement, accessoires et câbles Pag. 741/742

Xenia_AF PRO | Linear profiles | powerLED 4,5 W DC 500 mA



4,5 W DC

Anod. AL.	82712	M 2700	561 - 0n req	08 Sym. Flood-
		W 3000	597 - 0n req	20 Flood -
		N 4000	639 - 0n req	50 W.Flood -

3 LEDs

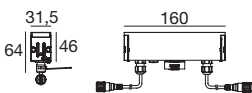

Optic

08 Sym. Flood-	-
20 Flood	-
50 W.Flood	-
90 E.W.Flood-	-
25 Elliptic	-
07 Asymm.	-

99181 99185 83101
 ON/OFF 1-2 art. p 78 x l 100 x h 31 ON/OFF 2-4 art. p 92 x l 117 x h 38 DALI 1-4 art. p 53 x l 121 x h 26

Support de fixation, boîtier d'encastrement, accessoires et câbles Pag. 741/742

Xenia_AF PRO | Linear profiles | 190-250V AC | powerLED



7,4 W DC - 8,3 W AC

Anod. AL.	82496	M 2700	1086 - 0n req	08 Sym. Flood-
		W 3000	1164 - 0n req	20 Flood -
		N 4000	1242 - 0n req	50 W.Flood -

6 LEDs

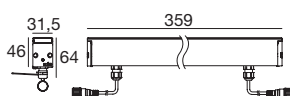

Cct

Im S - D

Optic

14,8 W DC - 16,5 W AC

Anod. AL.	82497	M 2700	2172 - 0n req	08 Sym. Flood-
		W 3000	2328 - 0n req	20 Flood -
		N 4000	2484 - 0n req	50 W.Flood -

12 LEDs

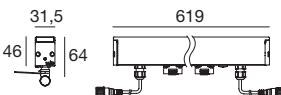

Cct

Im S - D

Optic

22,2 W DC - 24,8 W AC

Anod. AL.	82498	M 2700	3078 - 0n req	08 Sym. Flood-
		W 3000	3294 - 0n req	20 Flood -
		N 4000	3510 - 0n req	50 W.Flood -

18 LEDs

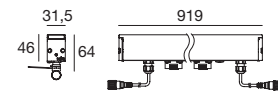

Cct

Im S - D

Optic

29,6 W DC - 33,2 W AC

Anod. AL.	82499	M 2700	4104 - 0n req	08 Sym. Flood-
		W 3000	4392 - 0n req	20 Flood -
		N 4000	4680 - 0n req	50 W.Flood -

24 LEDs

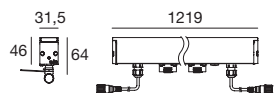

Cct

Im S - D

Optic

37 W DC - 41,3 W AC

Anod. AL.	82500	M 2700	5130 - 0n req	08 Sym. Flood-
		W 3000	5490 - 0n req	20 Flood -
		N 4000	5850 - 0n req	50 W.Flood -

30 LEDs

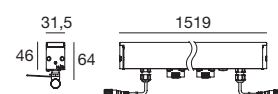

Cct

Im S - D

Optic

Support de fixation, boîtier d'encastrement, accessoires et câbles Pag. 741/742

Xenia_AF PRO | Linear profiles | 190-250V AC | powerLED



8,4 W DC - 10,1 W AC **Cct** **lm S - D** **Optic**

Anod. AL. 82505	M 2700	1272 - 0n req	08 Sym. Flood-
	W 3000	1368 - 0n req	20 Flood -
	N 4000	1452 - 0n req	50 Flood -

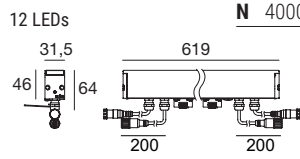

12,8 W DC - 14,4 W AC **Cct** **lm S - D** **Optic**

Anod. AL. 82506	M 2700	1908 - 0n req	08 Sym. Flood-
	W 3000	2052 - 0n req	20 Flood -
	N 4000	2178 - 0n req	50 W.Flood -

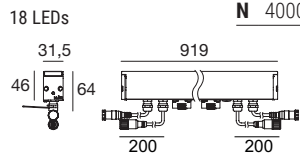

17,1 W DC - 19,1 W AC **Cct** **lm S - D** **Optic**

Anod. AL. 82507	M 2700	2544 - 0n req	08 Sym. Flood-
	W 3000	2736 - 0n req	20 Flood -
	N 4000	2904 - 0n req	50 W.Flood -

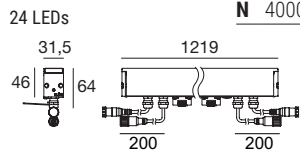

21,4 W DC - 24 W AC **Cct** **lm S - D** **Optic**

Anod. AL. 82508	M 2700	3180 - 0n req	08 Sym. Flood-
	W 3000	3420 - 0n req	20 Flood -
	N 4000	3630 - 0n req	50 Flood -

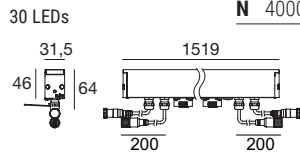

Support de fixation, boîtier d'encastrement, accessoires et câbles Pag. 741/742

Xenia_AF PRO RGBW DMX | Linear profiles | 100-240V AC | powerLED



7,3 W DC - 8,5 W AC **Optic**

Anod. AL. 84046	Q RGBW natural white	25 Elliptic -
	V RGBW warm white	

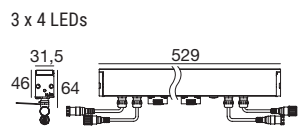

19,3 W DC - 22,6 W AC **Optic**

Anod. AL. 84045	Q RGBW natural white	25 Elliptic -
	V RGBW warm white	

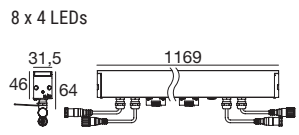

DMX **99385** **89365**
 DMX Controllers DMX/RDM 120 Ohm DMX line closure
 Pag. 952 - 953

Support de fixation, boîtier d'encastrement, accessoires et câbles Pag. 741/742

DW Dynamic White on request



7,4 W DC - 8,3 W AC	Cct	lm S - D	Optic
Anod. AL. 82330	M 2700	1086 - 0n req	08 Sym. Flood-
	W 3000	1164 - 0n req	20 Flood -
	N 4000	1242 - 0n req	50 W.Flood -
			90 E.W.Flood-
			25 Elliptic -
			07 Asymm. -

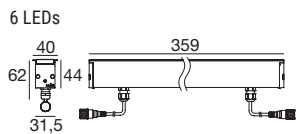

14,8 W DC - 16,5 W AC	Cct	lm S - D	Optic
Anod. AL. 82331	M 2700	2172 - 0n req	08 Sym. Flood-
	W 3000	2328 - 0n req	20 Flood -
	N 4000	2484 - 0n req	50 W.Flood -
			90 E.W.Flood-
			25 Elliptic -
			07 Asymm. -

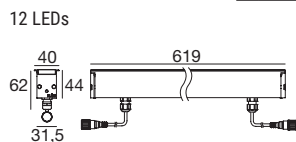

22,2 W DC - 24,8 W AC	Cct	lm S - D	Optic
Anod. AL. 82332	M 2700	3078 - 0n req	08 Sym. Flood-
	W 3000	3294 - 0n req	20 Flood -
	N 4000	3510 - 0n req	50 W.Flood -
			90 E.W.Flood-
			25 Elliptic -
			07 Asymm. -

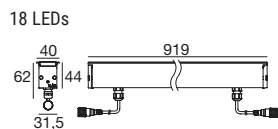

29,6 W DC - 33,2 W AC	Cct	lm S - D	Optic
Anod. AL. 82333	M 2700	4104 - 0n req	08 Sym. Flood-
	W 3000	4392 - 0n req	20 Flood -
	N 4000	4680 - 0n req	50 W.Flood -
			90 E.W.Flood-
			25 Elliptic -
			07 Asymm. -

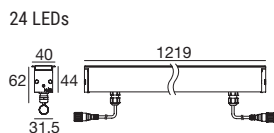

37 W DC - 41,3 W AC	Cct	lm S - D	Optic
Anod. AL. 82334	M 2700	5130 - 0n req	08 Sym. Flood-
	W 3000	5490 - 0n req	20 Flood -
	N 4000	5850 - 0n req	50 W.Flood -
			90 E.W.Flood-
			25 Elliptic -
			07 Asymm. -

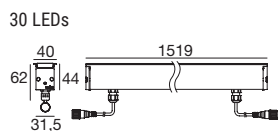

Boîtier d'encastrement, accessoires et câbles Pag. 741/742



DALI 8,4 W DC - 10,1 W AC	Cct	lm S - D	Optic
Anod. AL. 82326	M 2700	1272 - 0n req	08 Sym. Flood-
	W 3000	1368 - 0n req	20 Flood -
	N 4000	1452 - 0n req	50 Flood -
			90 E.W.Flood-
			25 Elliptic -
			07 Asymm. -

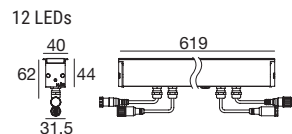

DALI 12,8 W DC - 14,4 W AC	Cct	lm S - D	Optic
Anod. AL. 82327	M 2700	1908 - 0n req	08 Sym. Flood-
	W 3000	2052 - 0n req	20 Flood -
	N 4000	2178 - 0n req	50 W.Flood -
			90 E.W.Flood-
			25 Elliptic -
			07 Asymm. -

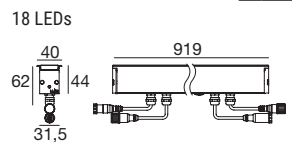

DALI 17,1 W DC - 19,1 W AC	Cct	lm S - D	Optic
Anod. AL. 82328	M 2700	2544 - 0n req	08 Sym. Flood-
	W 3000	2736 - 0n req	20 Flood -
	N 4000	2904 - 0n req	50 W.Flood -
			90 E.W.Flood-
			25 Elliptic -
			07 Asymm. -

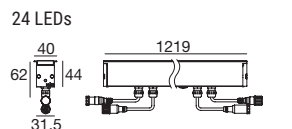

DALI 21,4 W DC - 24 W AC	Cct	lm S - D	Optic
Anod. AL. 82329	M 2700	3180 - 0n req	08 Sym. Flood-
	W 3000	3420 - 0n req	20 Flood -
	N 4000	3630 - 0n req	50 Flood -
			90 W.Flood -
			25 Elliptic -
			07 Asymm. -

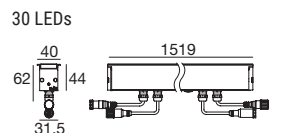

Boîtier d'encastrement, accessoires et câbles Pag. 741/742



7,4 W DC - 8,3 W AC

Anod. AL.	82553	Cct	lm S - D	Optic
		M 2700	1086 - 0n req	08 Sym. Flood-
		W 3000	1164 - 0n req	20 Flood -
		N 4000	1242 - 0n req	50 W.Flood -
				90 E.W.Flood-
				25 Elliptic -
				07 Asymm. -

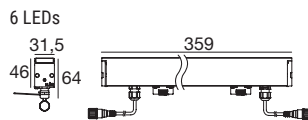

14,8 W DC - 16,5 W AC

Anod. AL.	82554	Cct	lm S - D	Optic
		M 2700	2172 - 0n req	08 Sym. Flood-
		W 3000	2328 - 0n req	20 Flood -
		N 4000	2484 - 0n req	50 W.Flood -
				90 E.W.Flood-
				25 Elliptic -
				07 Asymm. -

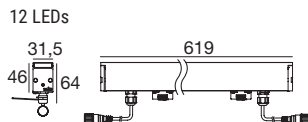

22,2 W DC - 24,8 W AC

Anod. AL.	82555	Cct	lm S - D	Optic
		M 2700	3078 - 0n req	08 Sym. Flood-
		W 3000	3294 - 0n req	20 Flood -
		N 4000	3510 - 0n req	50 W.Flood -
				90 E.W.Flood-
				25 Elliptic -
				07 Asymm. -

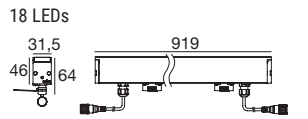

29,6 W DC - 33,2 W AC

Anod. AL.	82556	Cct	lm S - D	Optic
		M 2700	4104 - 0n req	08 Sym. Flood-
		W 3000	4392 - 0n req	20 Flood -
		N 4000	4680 - 0n req	50 W.Flood -
				90 E.W.Flood-
				25 Elliptic -
				07 Asymm. -

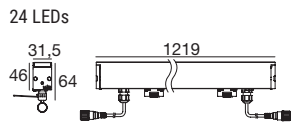

37W DC - 41,3 W AC

Anod. AL.	82557	Cct	lm S - D	Optic
		M 2700	5130 - 0n req	08 Sym. Flood-
		W 3000	5490 - 0n req	20 Flood -
		N 4000	5850 - 0n req	50 W.Flood -
				90 E.W.Flood-
				25 Elliptic -
				07 Asymm. -

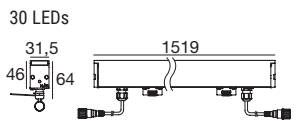

Support de fixation, boîtier d'encastrement, accessoires et câbles Pag. 741/742



8,4 W DC - 10,1 W AC

Anod. AL.	82562	Cct	lm S - D	Optic
		M 2700	1272 - 0n req	08 Sym. Flood-
		W 3000	1368 - 0n req	20 Flood -
		N 4000	1452 - 0n req	50 W.Flood -
				90 E.W.Flood-
				25 Elliptic -
				07 Asymm. -

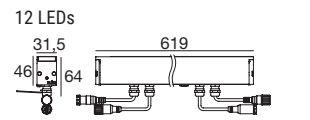

12,8 W DC - 14,4 W AC

Anod. AL.	82563	Cct	lm S - D	Optic
		M 2700	1908 - 0n req	08 Sym. Flood-
		W 3000	2052 - 0n req	20 Flood -
		N 4000	2178 - 0n req	50 W.Flood -
				90 E.W.Flood-
				25 Elliptic -
				07 Asymm. -

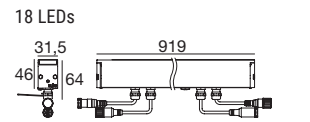

17,1 W DC - 19,1 W AC

Anod. AL.	82564	Cct	lm S - D	Optic
		M 2700	2544 - 0n req	08 Sym. Flood-
		W 3000	2736 - 0n req	20 Flood -
		N 4000	2904 - 0n req	50 W.Flood -
				90 E.W.Flood-
				25 Elliptic -
				07 Asymm. -

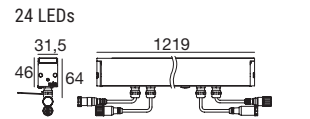

21,4 W DC - 24 W AC

Anod. AL.	82565	Cct	lm S - D	Optic
		M 2700	3180 - 0n req	08 Sym. Flood-
		W 3000	3420 - 0n req	20 Flood -
		N 4000	3630 - 0n req	50 W.Flood -
				90 E.W.Flood-
				25 Elliptic -
				07 Asymm. -

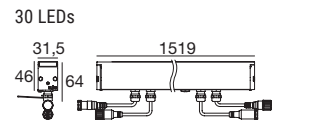

Support de fixation, boîtier d'encastrement, accessoires et câbles Pag. 741/742

Support de fixation



description	
98949	Support de fixation 46-67 mm
suitable for: Xenia_W / Xenia_W PRO	
Xenia_AF / Xenia_ALF / Xenia_AF PRO Xenia_AF RGBW DMX / Xenia_AF PRO RGBW DMX Xenia_AF PRO Micro Louvre	



description	
89045	Support de fixation 90 mm
suitable for: Xenia_W / Xenia_W PRO	



description	
89046	Support de fixation 150 mm
suitable for: Xenia_W / Xenia_W PRO	



description	
89047	Support de fixation 300 mm
suitable for: Xenia_W / Xenia_W PRO	

Boîtier d'encastrement



description	
99972	160 mm
99761	360 mm
99762	620 mm
99763	920 mm
99764	1220 mm
99765	1520 mm
suitable for: Xenia_A / Xenia_AL / Xenia_A PRO Xenia_A PRO Micro Louvre	
RGBW	
99820	530 mm
99821	1170 mm
suitable for: Xenia_A RGBW DMX Xenia_A PRO RGBW DMX	

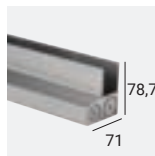

description	
99926	160 mm
99912	359 mm
99913	619 mm
99914	919 mm
99915	1219 mm
99916	1519 mm
suitable for: Xenia_AF / Xenia_ALF / Xenia_AF PRO Xenia_AF PRO Micro Louvre	
RGBW	
99918	529 mm
99919	1169 mm
suitable for: Xenia_AF RGBW / Xenia_AF Pro RGBW DMX	

Accessoires



description	
99766	Bouchons de fermeture
suitable for: Xenia_A / Xenia_AL / Xenia_A RGBW DMX Xenia_A PRO (not for L 160 mm) Xenia_A PRO RGBW DMX / Xenia_A PRO MicroLouvre	



description	
83188	Bouchons de fermeture
suitable for: Xenia_A PRO (L 160 mm) Xenia_A PRO MicroLouvre	



description	
99818	Ressorts
suitable for: Xenia_A / Xenia_AL / Xenia_A PRO Xenia_A PRO MicroLouvre / Xenia_A RGBW DMX Xenia_A PRO RGBW DMX	

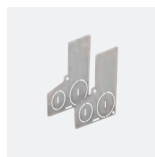

description	
99917	Bouchons de fermeture
suitable for: Xenia_AF / Xenia_ALF / Xenia_AF PRO Xenia_AF RGBW DMX / Xenia_AF PRO RGBW DMX Xenia_AF PRO MicroLouvre	

Accessoires

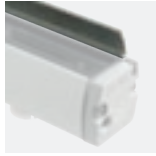

description	
98782	Anti-éblouissement 366 mm
suitable for: Xenia_W / Xenia_W PRO	

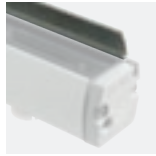

description	
98783	Anti-éblouissement 630 mm
suitable for: Xenia_W / Xenia_W PRO	

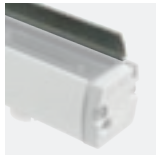

description	
98784	Anti-éblouissement 930 mm
suitable for: Xenia_W / Xenia_W PRO	



description	
98785	Anti-éblouissement 1230 mm
suitable for: Xenia_W / Xenia_W PRO	



description	
99778	Anti-éblouissement 1530 mm
suitable for: Xenia_W / Xenia_W PRO	

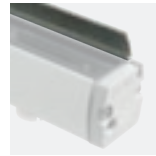

description	
98951	Anti-éblouissement 500 mm
suitable for: Xenia_W PRO RGBW DMX	

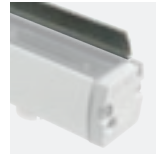

description	
98953	Anti-éblouissement 535 mm
suitable for: Xenia_W RGBW DMX	



description	
98952	Anti-éblouissement 1182 mm
suitable for: Xenia_W RGBW DMX Xenia_W PRO RGBW DMX	

Câbles



24V DC 190-250V AC	
99216	Conn. F.4 pin M12 (L 1,5m)
89190	Conn. F.4 pin M12 (L 5m)
suitable for: Xenia	



DMX	
89189	Conn. M.5 pin M12 (L 5m)
suitable for: Xenia	



DMX	
89186	Conn. M.5 pin M12 + M.3 pin XLR (L 5m)
suitable for: Xenia	

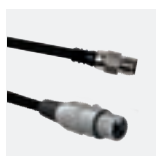

DMX	
98494	Conn. M.5 pin M12 + F.3 pin XLR (L 5m)
suitable for: Xenia	



DMX	
98493	Conn. M.5 pin M12 + M.5 pin XLR (L 5m)
suitable for: Xenia	



1-10V & DALI	
99879	Conn M. 5 pin M12 (L 5m)
suitable for: Xenia	

Câbles d'extension



24V DC 190-250V AC	
98437	Conn M. + F. 4 pin M12 (L 1m)
98149	Conn M. + F. 4 pin M12 (L 5m)
89188	Conn M. + F. 4 pin M12 (L 10m)
suitable for: Xenia	



DMX	
98994	Conn. M. / F. 5 pin M12 (L 1m)
98993	Conn. M. / F. 5 pin M12 (L 5m)
89187	Conn. M. / F. 5 pin M12 (L 10m)
suitable for: Xenia	



1-10V & DALI	
89361	Conn M. + F. 5 pin M12 (L 10m)
suitable for: Xenia	



paseo

Matériaux

Corps en polycarbonate transparent ou opalin



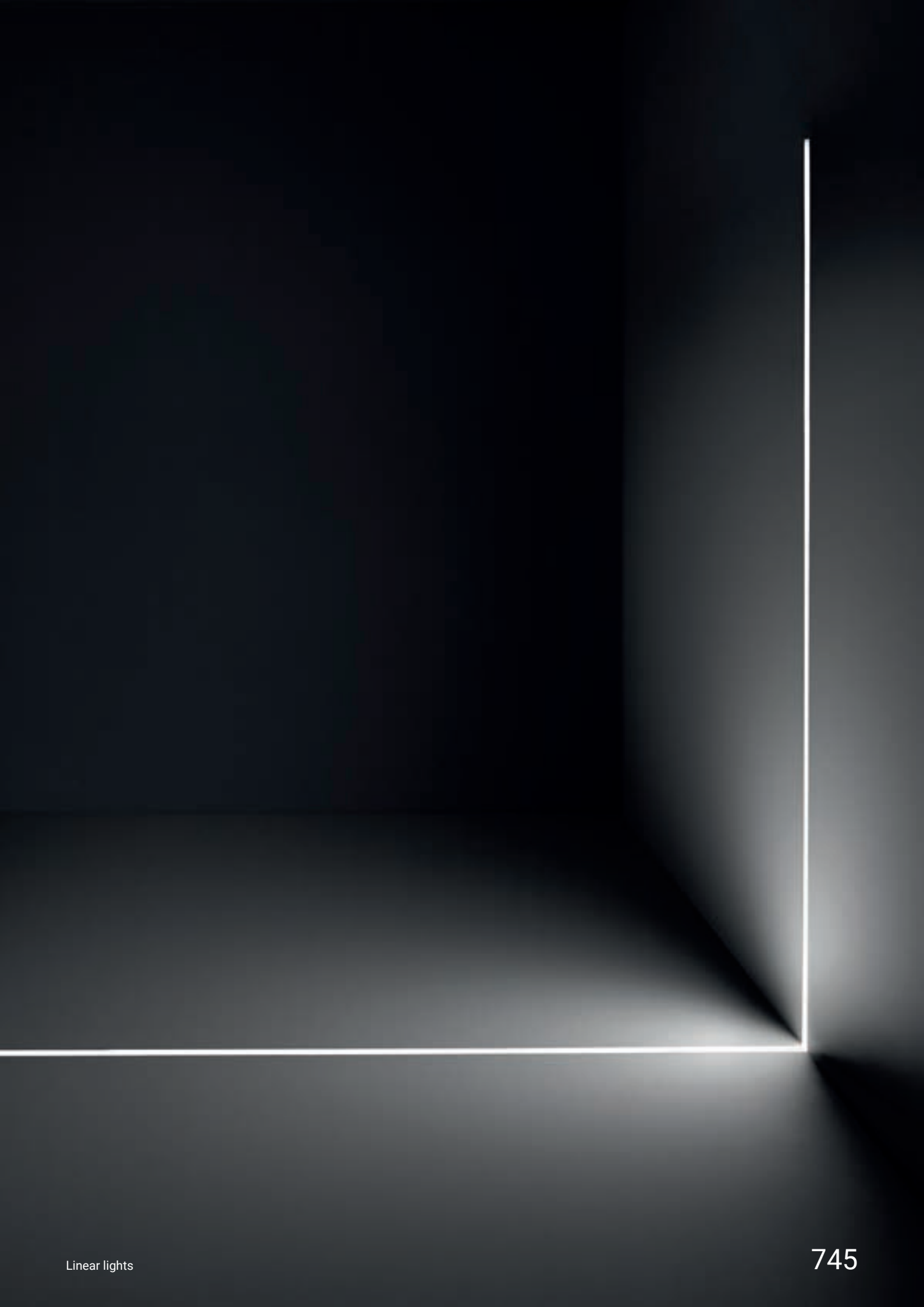

paseo range



	_L / _L Anti-glare	Dark	_X
3,5 W	-	594 x 26 mm	-
6,2 W 6,6 W	512 x 24 mm	-	-
7 W	-	1176 x 26 mm	576 x 24 mm
8 W	-	-	576 x 24 mm
8,7 W	-	1467 x 26 mm	-
13,1 W 13,6 W	1152 x 24 mm	-	-
17 W 17,3 W	-	-	1152 x 24 mm
19,5 W	1452 x 24 mm	-	-
Finish	Transp. Opaline	Black	Transp.
topLED	2700K - 3000K - 4000K - RGBW	2700K - 3000K - 4000K	-
powerLED	-	-	2700K - 3000K - 4000K - RGBW
Optics	Spot - Flood - Asymmetric - General	General	Spot - Flood - W.Flood - Elliptic
Driver	On/Off - 0/1-10V - DALI	On/Off - DALI/PUSH - DMX	-
Driver	On/Off - DMX	-	On/Off - 1/10 V - DALI - DMX

Dimensions minimales

Encore plus minces, encore plus polyvalents : les nouveaux modèles Paseo, avec des profils allant de 24 à 26 mm de largeur, s'adaptent facilement à toutes les exigences conceptuelles en tirant parti des dimensions extrêmement réduites alliées à une esthétique sobre et minimaliste.

24 mm

Dimensions réelles

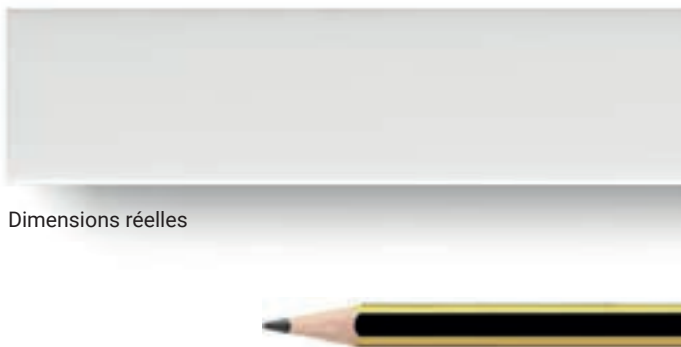

La gamme Paseo comprend un large éventail d'optiques, de longueurs, de températures de couleur et de types de contrôle tels que DALI et 1-10 V, ou RGBW DMX et RGB pixel (**Pag. 851**) pour gérer de manière dynamique les sources de lumière et donner vie à des mises en scène spectaculaires d'éclairage architectural. Grâce aux boîtiers d'encastrement et aux nombreux accessoires, il est également possible d'installer Paseo, au mur, au plafond ou encastré.

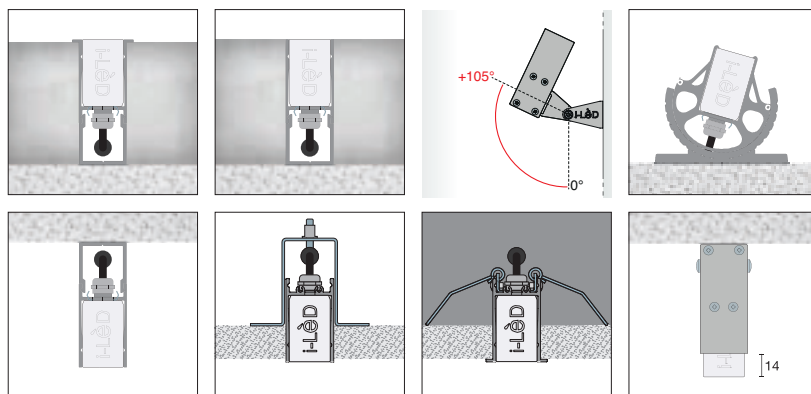

Protection maximale

Une décharge électrostatique se produit lors d'un transfert de charge entre deux corps voisins ou en contact. Cette décharge peut, dans certains cas, endommager les composants électroniques et les modules LED. Les Paseo avec driver intégré sont équipés d'un dispositif de protection contre les décharges électrostatiques (ESD) allant jusqu'à 4 KV.



Les bouchons soudés par ultrason garantissent résistance mécanique parfaite et continuité lumineuse

Câbles en polyuréthane thermoplastique avec connecteurs IP67 à connexion rapide en M12 à 4 ou 5 pôles

Ressort en acier pour une fixation stable du profilé Paseo au boîtier encastrable

Appareil équipé d'une vanne TCS® pour empêcher la formation d'humidité à l'intérieur du profilé

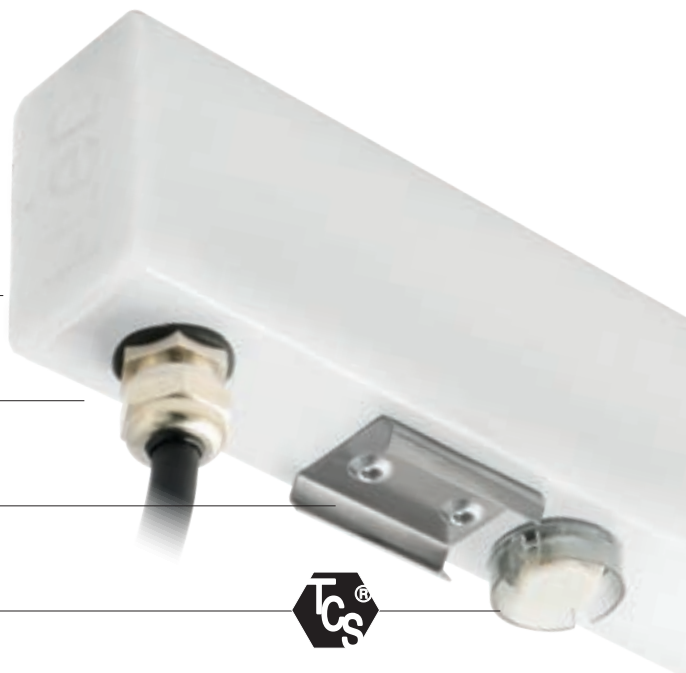

Paseo_L | Linear profiles | 24V DC | topLED



6,6 W DC	Cct	lm S - D	Optic
Transp. 97673	M 2700	662 - 507	20 Flood (37°)
	W 3000	720 - 760	07 Asymm. -
	N 4000	749 - 777	

6,6 W DC	Cct	lm S - D	Optic
Opaline 81328	M 2700	662 - 330	00 General (120°)
	W 3000	720 - 393	
	N 4000	749 - 405	

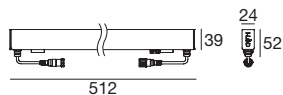

89179	89359	99331	99332	99722
ON/OFF 1 - 4 art.	ON/OFF 1 - 8 art.	ON/OFF 1 - 25 art.	0/1-10V 1 - 25 art.	DALI 1 - 20 art.
p 92 x l 117 x h 38	p 115 x l 140 x h 50	p 150 x l 60 x h 35	p 150 x l 60 x h 35	p 191 x l 63 x h 38

13,6 W DC	Cct	lm S - D	Optic
Transp. 97674	M 2700	1208 - 931	20 Flood (34°)
	W 3000	1313 - 1168	07 Asymm. -
	N 4000	1365 - 1198	

13,6 W DC	Cct	lm S - D	Optic
Opaline 81329	M 2700	1208 - 624	00 General (137°)
	W 3000	1313 - 849	
	N 4000	1365 - 922	

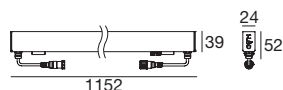

89179	89359	99331	99332	99722
ON/OFF 1 - 2 art.	ON/OFF 1 - 4 art.	ON/OFF 1 - 12 art.	0/1-10V 1 - 12 art.	DALI 1 - 10 art.
p 92 x l 117 x h 38	p 115 x l 140 x h 50	p 150 x l 60 x h 35	p 150 x l 60 x h 35	p 191 x l 63 x h 38

19,5 W DC	Cct	lm S - D	Optic
Transp. 97675	M 2700	1913 - 1474	20 Flood (34°)
	W 3000	2079 - 1825	07 Asymm. -
	N 4000	2162 - 1866	

19,5 W DC	Cct	lm S - D	Optic
Opaline 81330	M 2700	1913 - 988	00 General (148°)
	W 3000	2079 - 1133	
	N 4000	2162 - 1168	

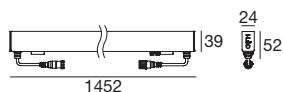

89179	89359	99331	99332	99722
ON/OFF 1 art.	ON/OFF 1 - 2 art.	ON/OFF 1 - 7 art.	0/1-10V 1 - 7 art.	DALI 1 - 6 art.
p 92 x l 117 x h 38	p 115 x l 140 x h 50	p 150 x l 60 x h 35	p 150 x l 60 x h 35	p 191 x l 63 x h 38

Câbles, boîtier d'encastrement et accessoires Pag. 754-757

Paseo_L | Linear profiles | 190-250 V AC | topLED

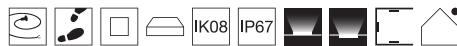

6,6 W DC - 7,4 W AC	Cct	lm S - D	Optic
Transp. 96150	M 2700	662 - 507	20 Flood (37°)
	W 3000	720 - 760	07 Asymm. -
	N 4000	749 - 777	

6,6 W DC - 7,4 W AC	Cct	lm S - D	Optic
Opaline 81331	M 2700	662 - 330	00 General (120°)
	W 3000	720 - 393	
	N 4000	749 - 405	

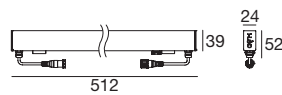

13,6 W DC - 15,2 W AC	Cct	lm S - D	Optic
Transp. 96151	M 2700	1208 - 931	20 Flood (34°)
	W 3000	1313 - 1365	07 Asymm. -
	N 4000	1365 - 1400	

13,6 W DC - 15,2 W AC	Cct	lm S - D	Optic
Opaline 81332	M 2700	1208 - 931	00 General (137°)
	W 3000	1313 - 1365	
	N 4000	1365 - 1400	

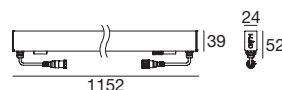

19,5 W DC - 21,8 W AC	Cct	lm S - D	Optic
Transp. 96152	M 2700	1913 - 1474	20 Flood (34°)
	W 3000	2079 - 1825	07 Asymm. -
	N 4000	2162 - 1866	

19,5 W DC - 21,8 W AC	Cct	lm S - D	Optic
Opaline 81333	M 2700	1913 - 988	00 General (148°)
	W 3000	2079 - 1133	
	N 4000	2162 - 1168	

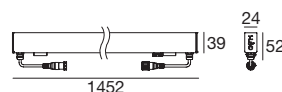

Câbles, boîtier d'encastrement et accessoires Pag. 754-757

RTG **81332W00**

Paseo_L | Linear profiles | 24V DC | topLED 12 W/m



6,6 W DC	Cct	lm S - D	Optic
Transp. 94021	M 2700	662 - 264	20 Spot -
	W 3000	720 - 288	07 Asymm. -
	N 4000	749 - 294	

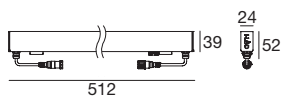

89179	89359	99331	99332	99722
ON/OFF 1 - 4 art. p 92 x l 117 x h 38	ON/OFF 1 - 8 art. p 115 x l 140 x h 50	ON/OFF 1 - 25 art. p 150 x l 60 x h 35	0/1-10V 1 - 25 art. p 150 x l 60 x h 35	DALI 1 - 20 art. p 191 x l 63 x h 38

13,6 W DC	Cct	lm S - D	Optic
Transp. 94022	M 2700	1208 - 496	20 Spot -
	W 3000	1313 - 537	07 Asymm. -
	N 4000	1365 - 548	

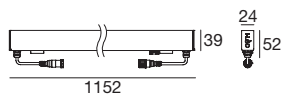

89179	89359	99331	99332	99722
ON/OFF 1 - 2 art. p 92 x l 117 x h 38	ON/OFF 1 - 4 art. p 115 x l 140 x h 50	ON/OFF 1 - 12 art. p 150 x l 60 x h 35	0/1-10V 1 - 12 art. p 150 x l 60 x h 35	DALI 1 - 10 art. p 191 x l 63 x h 38

Câbles, boîtier d'encastrement et accessoires Pag. 754-757

Paseo_L Anti-glare | Linear profiles | 190-250 V AC | topLED 12 W/m



6,2 W DC - 7 W AC	Cct	lm S - D	Optic
Transp. 93994	M 2700	662 - 264	20 Spot -
	W 3000	720 - 288	07 Asymm. -
	N 4000	749 - 294	

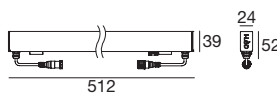

13,1 W DC - 15 W AC	Cct	lm S - D	Optic
Transp. 93995	M 2700	1208 - 496	20 Spot -
	W 3000	1313 - 537	07 Asymm. -
	N 4000	1365 - 548	

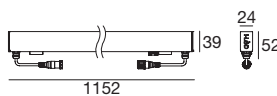

Câbles, boîtier d'encastrement et accessoires Pag. 754-757

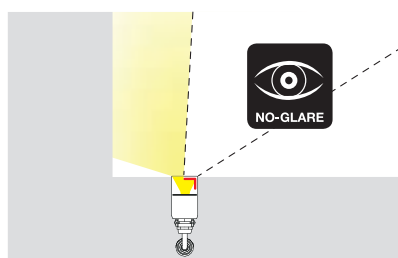

Appareil doté d'un profilé anti-éblouissement pour réduire l'éblouissement direct. L'intensité de l'émission lumineuse reste toutefois inchangée. (93994 / 93995)

Paseo_L | Linear profiles | 24V DC | topLED

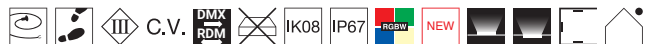

6,6 W DC

Opaline **84055**

Q RGBW natural white
V RGBW warm white

Optic

00 General -

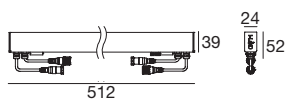

Driver	Switching	DMX	99385	89365
ON/OFF 24V DC 14W - 150W Pag. 940 - 941	24V DC Switching 50W - 750W Pag. 932	DMX Controllers Pag. 952 - 953	DMX/RDM addresser	120 Ohm DMX line closure

13,6 W DC

Opaline **84056**

Q RGBW natural white
V RGBW warm white

Optic

00 General -

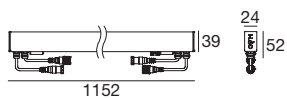

Driver	Switching	DMX	99385	89365
ON/OFF 24V DC 14W - 150W Pag. 940 - 941	24V DC Switching 50W - 750W Pag. 932	DMX Controllers Pag. 952 - 953	DMX/RDM addresser	120 Ohm DMX line closure

19,5 W DC

Opaline **84057**

Q RGBW natural white
V RGBW warm white

Optic

00 General -

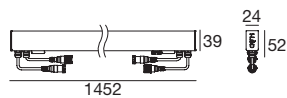

Driver	Switching	DMX	99385	89365
ON/OFF 24V DC 14W - 150W Pag. 940 - 941	24V DC Switching 50W - 750W Pag. 932	DMX Controllers Pag. 952 - 953	DMX/RDM addresser	120 Ohm DMX line closure

Câbles, boîtier d'encastrement et accessoires Pag. 754-757

Paseo Dark | Linear profiles | 48V DC | topLED

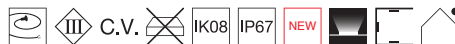

3,5 W DC

Black **84214**

Cct

M 2700
W 3000
N 4000

lm S - D

441 - On req.
450 - On req.
495 - On req.

Optic

00 General -

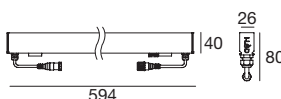

99784	99785	83180	83178
On/Off 150W CV 48V	On/Off 240W CV 48V	DALI/PUSH 150W CV 48V	Switching CV 48V DMX 384W



7 W DC

Black **84215**

Cct

M 2700
W 3000
N 4000

lm S - D

882 - On req.
900 - On req.
990 - On req.

Optic

00 General -

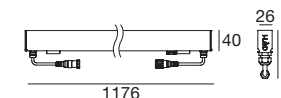

99784	99785	83180	83178
On/Off 150W CV 48V	On/Off 240W CV 48V	DALI/PUSH 150W CV 48V	Switching CV 48V DMX 384W



8,7 W DC

Black **84216**

Cct

M 2700
W 3000
N 4000

lm S - D

1103 - On req.
1125 - On req.
1238 - On req.

Optic

00 General -

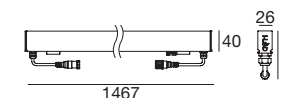

99784	99785	83180	83178
On/Off 150W CV 48V	On/Off 240W CV 48V	DALI/PUSH 150W CV 48V	Switching CV 48V DMX 384W



Accessoires Pag. 757

Pour les câbles et l'alimentation/l'unité de contrôle, contacter le service d'assistance Linea Light.

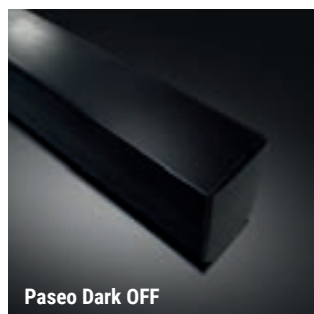

Paseo Dark OFF

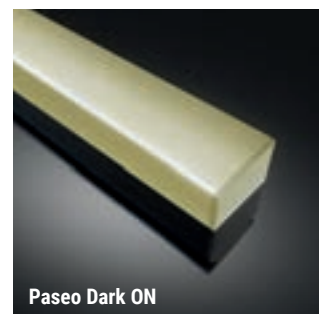

Paseo Dark ON



Paseo_X | Linear profiles | 190-250 V AC | powerLED



7 W DC - 7,7 W AC	Cct	lm S - D	Optic
Transp. 96196	M 2700	1032 - On req	08 Spot (17°)
	W 3000	1104 - On req	15 Flood (26°)
	N 4000	1175 - On req	30 Flood (29°)
			60 W.Flood (51°)
			25 Elliptic -

12 LEDs

576

17,3 W DC - 19,4 W AC	Cct	lm S - D	Optic
Transp. 96197	M 2700	2544 - On req	08 Spot (17°)
	W 3000	2736 - On req	15 Flood (26°)
	N 4000	2904 - On req	30 Flood (29°)
			60 W.Flood (51°)
			25 Elliptic -

24 LEDs

1152

Paseo_X | Linear profiles | 190-250 V AC | powerLED



7 W DC - 7,7 W AC	Cct	lm S - D	Optic
Transp. 97255	M 2700	1128 - On req	08 Spot (17°)
	W 3000	1212 - On req	15 Flood (26°)
	N 4000	1284 - On req	30 Flood (29°)
			60 W.Flood (51°)
			25 Elliptic -

12 LEDs

576

17,3 W DC - 19,4 W AC	Cct	lm S - D	Optic
Transp. 97611	M 2700	2256 - On req	08 Spot (17°)
	W 3000	2424 - On req	15 Flood (26°)
	N 4000	2568 - On req	30 Flood (29°)
			60 W.Flood (51°)
			25 Elliptic -

24 LEDs

1152

Câbles, boîtier d'encastrement et accessoires Pag. 754-757

Paseo_X | Linear profiles | 190-250 V AC | powerLED



7 W DC - 7,7 W AC	Cct	lm S - D	Optic
Transp. 97256	M 2700	1128 - On req	08 Spot (17°)
	W 3000	1212 - On req	15 Flood (26°)
	N 4000	1284 - On req	30 Flood (29°)
			60 W.Flood (51°)
			25 Elliptic -

12 LEDs

576

17,3 W DC - 19,4 W AC	Cct	lm S - D	Optic
Transp. 97612	M 2700	2256 - On req	08 Spot (17°)
	W 3000	2424 - On req	15 Flood (26°)
	N 4000	2568 - On req	30 Flood (29°)
			60 W.Flood (51°)
			25 Elliptic -

24 LEDs

1152

Paseo_X | Linear profiles | 190-250 V AC | powerLED



8 W DC - 9 W AC		Optic
Transp. 84058	Q RGBW natural white	25 Elliptic -
	V RGBW warm white	

12 LEDs

576

17 W DC - 19 W AC		Optic
Transp. 84059	Q RGBW natural white	25 Elliptic -
	V RGBW warm white	

24 LEDs

1152

DMX 99385 89365
 DMX Controllers DMX/RDM 120 Ohm DMX line closure
 Pag. 952 - 953

Câbles, boîtier d'encastrement et accessoires Pag. 754-757



Câbles



24V DC 190-250V AC

99216 Conn. F.4 pin M12 (L 1,5m)

89190 Conn. F.4 pin M12 (L 5m)

suitable for: Paseo



DMX

89189 Conn. M.5 pin M12 (L 5m)

suitable for: Paseo



DMX

89186 Conn. M.5 pin M12 + M.3 pin XLR (L 5m)

suitable for: Paseo



DMX

98494 Conn. M.5 pin M12 + F.3 pin XLR (L 5m)

suitable for: Paseo



DMX

98493 Conn. M.5 pin M12 + M.5 pin XLR (L 5m)

suitable for: Paseo



1-10V & DALI

99879 Conn M. 5 pin M12 (L 5m)

suitable for: Paseo

RTG 99216 / 89190

Câbles d'extension



24V DC 190-250V AC

98437 Conn M. + F. 4 pin M12 (L 1m)

98149 Conn M. + F. 4 pin M12 (L 5m)

89188 Conn M. + F. 4 pin M12 (L 10m)

suitable for: Paseo



DMX

98994 Conn. M. / F. 5 pin M12 (L 1m)

98993 Conn. M. / F. 5 pin M12 (L 5m)

89187 Conn. M. / F. 5 pin M12 (L 10m)

suitable for: Paseo



1-10V & DALI

89361 Conn M. + F. 5 pin M12 (L 10m)

suitable for: Paseo

Paseo | Boîtier encastrable pour installation encastrée au sol

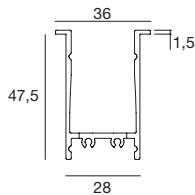

Boîtier d'encastrement

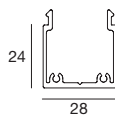

Passe-câble

Boîtier d'encastrement	Passe-câble	
98355	98471	Anod. Al. 513 mm x Paseo 512 mm
98430	98472	Anod. Al. 577 mm x Paseo 576 mm
98356	98473	Anod. Al. 1153 mm x Paseo 1152 mm
98357	98474	Anod. Al. 1453 mm x Paseo 1452 mm

suitable for: Paseo_L / Paseo_L Anti-glare / Paseo_X

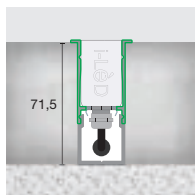

Accessoires pour l'installation

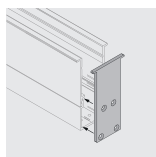

98876
2 x embouts pour la fermeture du profilé.

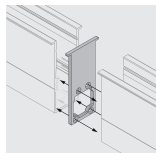

98553
Bouchon de jonction entre boîtiers encastrables avec trou pour le passage de câble
2 pièces

RTG 98356

Paseo | Boîtier encastrable pour installation affleurante au sol ou au plafond

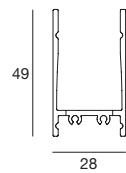

Boîtier d'encastrement

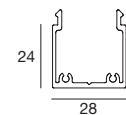

Passe-câble

Boîtier d'encastrement	Passe-câble	
98467	98471	Anod. Al. 513 mm x Paseo 512 mm
98468	98472	Anod. Al. 577 mm x Paseo 576 mm
98469	98473	Anod. Al. 1153 mm x Paseo 1152 mm
98470	98474	Anod. Al. 1453 mm x Paseo 1452 mm

suitable for: Paseo_L / Paseo_L Anti-glare / Paseo_X

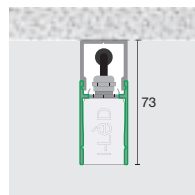
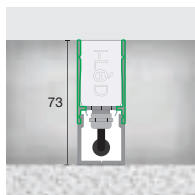

Accessoires pour l'installation



98466
2 x embouts pour la fermeture du profilé.

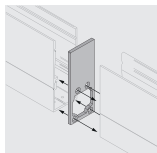

98554
Bouchon de jonction entre boîtiers encastrables avec trou pour le passage de câble
2 pièces

RTG 98469

RTG 98473

Paseo | Boîtier encastrable pour installation sur faux plafonds avec ressorts

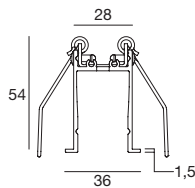

Anod. AL	98374	513 mm x Paseo 512 mm
Anod. AL	98435	577 mm x Paseo 576 mm
Anod. AL	98375	1153 mm x Paseo 1152 mm
Anod. AL	98376	1453 mm x Paseo 1452 mm

suitable for: Paseo_L / Paseo_X

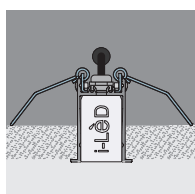

Accessoires pour l'installation

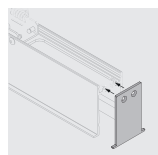

98465
2 x embouts pour la fermeture du profilé.

Paseo | Boîtier encastrable pour installation affleurante sur faux plafond

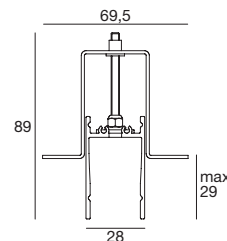

Anod. AL	98367	513 mm x Paseo 512 mm
Anod. AL	98434	577 mm x Paseo 576 mm
Anod. AL	98368	1153 mm x Paseo 1152 mm
Anod. AL	98369	1453 mm x Paseo 1452 mm

suitable for: Paseo_L / Paseo_X

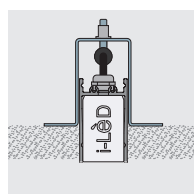

Accessoires pour l'installation



98464
2 x embouts pour la fermeture du profilé.

Paseo | Boîtier encastrable pour installation au plafond « 3D »

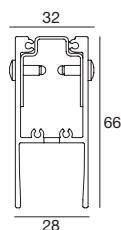

Anod. AL	98836	513 mm x Paseo 512 mm
Anod. AL	98839	577 mm x Paseo 576 mm
Anod. AL	98837	1153 mm x Paseo 1152 mm
Anod. AL	98838	1453 mm x Paseo 1452 mm

suitable for: Paseo_L / Paseo_X

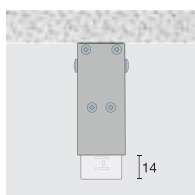

Accessoires pour l'installation



98840
2 x embouts pour la fermeture du profilé.

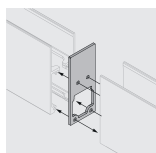

98841
Bouchon de jonction entre boîtiers encastrables avec trou pour le passage de câble
2 pièces

Paseo | Boîtier encastrable avec support pour installation murale

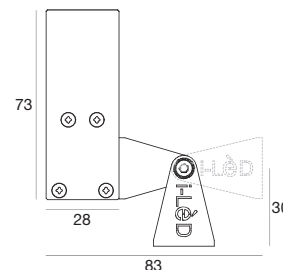

Anod. AL	98842	517 mm x Paseo 512 mm
Anod. AL	98843	581 mm x Paseo 576 mm
Anod. AL	98844	1157 mm x Paseo 1152 mm
Anod. AL	98845	1457 mm x Paseo 1452 mm

suitable for: Paseo_L / Paseo_X

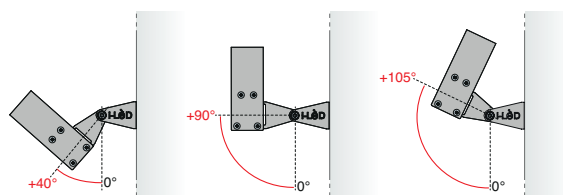

Accessoires pour l'installation

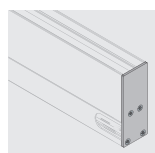

Included
2 x embouts pour la fermeture du profilé.

Paseo | Système de fixation orientable en appui

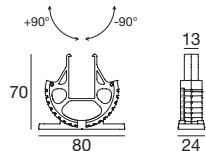

Transp. **98771** Clips orientables

suitable for: Paseo_L / Paseo_X

Paire de clips de fixation en polycarbonate transparent pour ne pas altérer le flux lumineux du Paseo. Accessoire orientable permettant de régler l'inclinaison du Paseo de +90° à -90°.



Paseo | Base de fixation

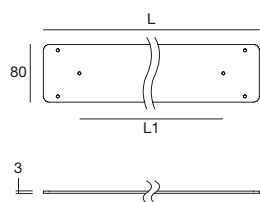

Steel **98772** L 300 - L1 200 mm Paseo 512 - 576 mm

Steel **98773** L 950 - L1 850 mm Paseo 1152 - 1452 mm

suitable for: Paseo_L / Paseo_X

Possibilité d'utiliser la plaque (plaque + clip + Paseo) indépendamment comme support mobile sans la fixer à une surface (clips 98771 non compris).

Paseo | Clé d'extraction

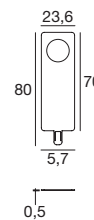

Anod. Al. **98475** Clé d'extraction

suitable for: Paseo_L / Paseo_X

La clé d'extraction Paseo est l'outil permettant d'extraire le Paseo du boîtier encastrable. Compatible avec tous les types de boîtiers encastrables Paseo.



Paseo | Étrier de support pour l'installation au mur



Steel **83162** Support de fixation

suitable for: Paseo_L / Paseo_X / Paseo_Dark

thin66

Matériaux

Corps en aluminium anodisé

Revêtement en résine de silicone opaline

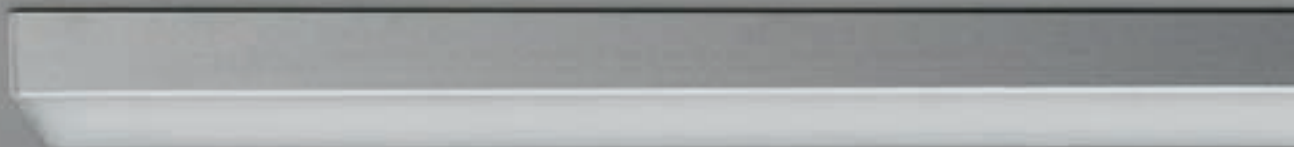

thin66 range

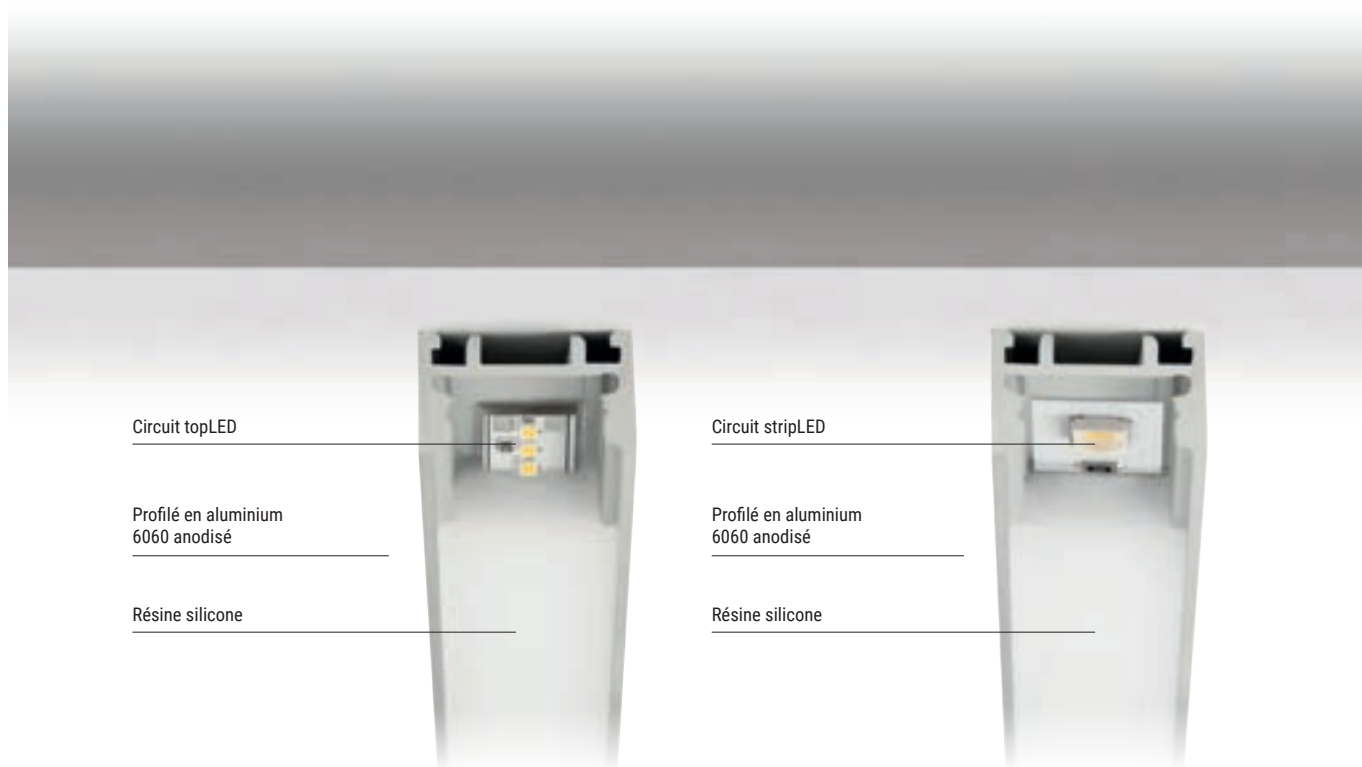

	Thin66	Thin66_RGBW
4,8 W	539 x 18 mm	-
9,6 W	1039 x 18 mm	539 x 18 mm
14,4 W	1539 x 18 mm	-
19,2 W	2039 x 18 mm	1039 x 18 mm
28,8 W	-	1539 x 18 mm
38,4 W	-	2039 x 18 mm
Finish	Anod. Al.	Anod. Al.
topLED	2700K - 3000K - 4000K	RGBW
Optics	General	General
Driver	On/Off 0/1-10V DALI	DMX

Thin66 | Linear profiles | 24V DC | topLED



4,8 W DC	M	Cct	lm S - D	Optic
Anod. AL. 83885		M 2700	425 - On req	00 General

4,8 W DC	M+F	W 3000	440 - On req	
Anod. AL. 83889		N 4000	480 - On req	

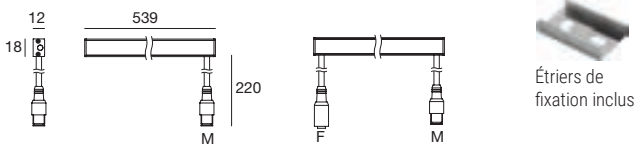

89179	89359	99331	99332	99722
ON/OFF 1-4 art. p 92 x l 117 x h 38	ON/OFF 1-8 art. p 115 x l 140 x h 50	ON/OFF 1-25 art. p 150 x l 160 x h 35	0/1-10V 1-25 art. p 150 x l 160 x h 35	DALI 1-20 art. p 191 x l 163 x h 38

9,6 W DC	M	Cct	lm S - D	Optic
Anod. AL. 83886		M 2700	850 - On req	00 General

9,6 W DC	M+F	W 3000	880 - On req	
Anod. AL. 83890		N 4000	960 - On req	

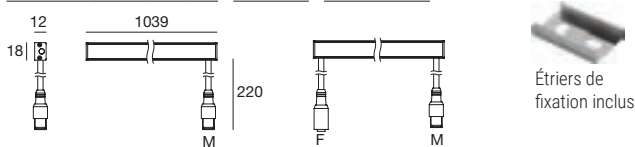

89179	89359	99331	99332	99722
ON/OFF 1-2 art. p 92 x l 117 x h 38	ON/OFF 1-4 art. p 115 x l 140 x h 50	ON/OFF 1-12 art. p 150 x l 160 x h 35	0/1-10V 1-12 art. p 150 x l 160 x h 35	DALI 1-10 art. p 191 x l 163 x h 38

14,4 W DC	M	Cct	lm S - D	Optic
Anod. AL. 83887		M 2700	1275 - On req	00 General

14,4 W DC	M+F	W 3000	1320 - On req	
Anod. AL. 83891		N 4000	1440 - On req	

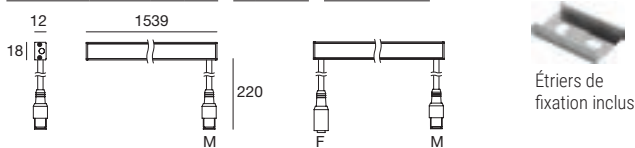

89179	89359	99331	99332	99722
ON/OFF 1 art. p 92 x l 117 x h 38	ON/OFF 1-2 art. p 115 x l 140 x h 50	ON/OFF 1-7 art. p 150 x l 160 x h 35	0/1-10V 1-7 art. p 150 x l 160 x h 35	DALI 1-6 art. p 191 x l 163 x h 38

19,2 W DC	M	Cct	lm S - D	Optic
Anod. AL. 83888		M 2700	1700 - On req	00 General

19,2 W DC	M+F	W 3000	1760 - On req	
Anod. AL. 83892		N 4000	1920 - On req	

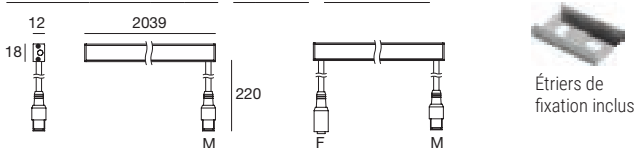

89179	89359	99331	99332	99722
ON/OFF 1 art. p 92 x l 117 x h 38	ON/OFF 1-2 art. p 115 x l 140 x h 50	ON/OFF 1-6 art. p 150 x l 160 x h 35	0/1-10V 1-6 art. p 150 x l 160 x h 35	DALI 1-5 art. p 191 x l 163 x h 38

Câbles Pag. 761

Thin66 RGBW | Linear profiles | 24V DC | topLED

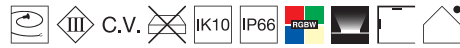

9,6 W DC	M	Optic
Anod. AL. 84060		V RGBW warm white 00 General -

9,6 W DC	M+F	
Anod. AL. 84064		

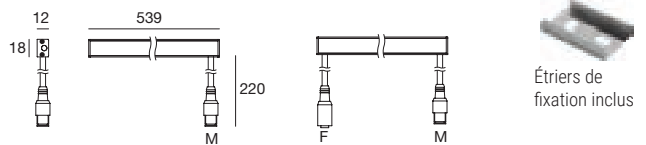

Driver	Switching	DMX	99385	89365
ON/OFF 24V DC 14W - 150W Pag. 940 - 941	24V DC Switching 50W - 750W Pag. 932	DMX Controllers Pag. 952 - 953	DMX/RDM addresser	120 Ohm DMX line closure

19,2 W DC	M	Optic
Anod. AL. 84061		V RGBW warm white 00 General -

19,2 W DC	M+F	
Anod. AL. 84065		

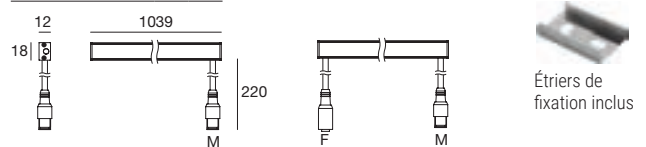

Driver	Switching	DMX	99385	89365
ON/OFF 24V DC 14W - 150W Pag. 940 - 941	24V DC Switching 50W - 750W Pag. 932	DMX Controllers Pag. 952 - 953	DMX/RDM addresser	120 Ohm DMX line closure

28,8 W DC	M	Optic
Anod. AL. 84062		V RGBW warm white 00 General -

28,8 W DC	M+F	
Anod. AL. 84066		

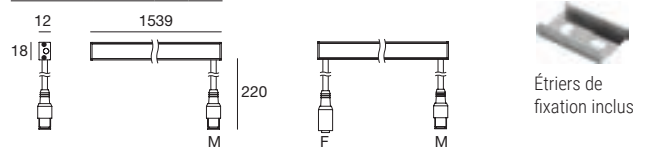

Driver	Switching	DMX	99385	89365
ON/OFF 24V DC 14W - 150W Pag. 940 - 941	24V DC Switching 50W - 750W Pag. 932	DMX Controllers Pag. 952 - 953	DMX/RDM addresser	120 Ohm DMX line closure

38,4 W DC	M	Optic
Anod. AL. 84063		V RGBW warm white 00 General -

38,4 W DC	M+F	
Anod. AL. 84067		

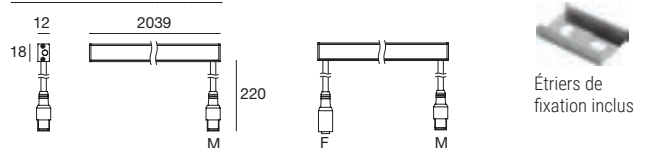

Driver	Switching	DMX	99385	89365
ON/OFF 24V DC 14W - 150W Pag. 940 - 941	24V DC Switching 50W - 750W Pag. 932	DMX Controllers Pag. 952 - 953	DMX/RDM addresser	120 Ohm DMX line closure

Câbles Pag. 761

Câbles



24V DC 190-250V AC

99216	Conn. F.4 pin M12 (L 1,5m)
89190	Conn. F.4 pin M12 (L 5m)

suitable for: Thin66



1-10V & DALI

89362	Conn F. 5 pin M12 (L 5m)
--------------	--------------------------

suitable for: Thin66 RGBW

Câbles d'extension



24V DC 190-250V AC

98437	Conn M. + F. 4 pin M12 (L 1m)
98149	Conn M. + F. 4 pin M12 (L 5m)
89188	Conn M. + F. 4 pin M12 (L 10m)

suitable for: Thin66



1-10V & DALI

89361	Conn M. + F. 5 pin M12 (L 10m)
--------------	--------------------------------

suitable for: Thin66 RGBW

GV11 | Dubai, UAE



ice-cut66

Matériaux

Corps en polycarbonate translucide

Ice-Cut66 | Linear profiles | 24V DC | topLED



6 W DC	Cct	lm S - D	Optic
Opaline 96740	M 2700	420 - 331	00 General -
	W 3000	438 - 344	
	N 4000	478 - 379	



89179	89359	99331	99332	99722
ON/OFF 1-4 art. p 92 x l 117 x h 38	ON/OFF 1-8 art. p 115 x l 140 x h 50	ON/OFF 1-25 art. p 150 x l 60 x h 35	0/1-10V 1-25 art. p 150 x l 60 x h 35	DALI 1-20 art. p 191 x l 63 x h 38

12 W DC	Cct	lm S - D	Optic
Opaline 96741	M 2700	840 - 663	00 General -
	W 3000	875 - 689	
	N 4000	956 - 758	

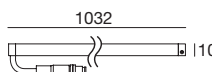

89179	89359	99331	99332	99722
ON/OFF 1-2 art. p 92 x l 117 x h 38	ON/OFF 1-4 art. p 115 x l 140 x h 50	ON/OFF 1-12 art. p 150 x l 60 x h 35	0/1-10V 1-12 art. p 150 x l 60 x h 35	DALI 1-10 art. p 191 x l 63 x h 38

18 W DC	Cct	lm S - D	Optic
Opaline 96742	M 2700	1260 - 995	00 General -
	W 3000	1313 - 1033	
	N 4000	1434 - 1137	

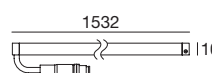

89179	89359	99331	99332	99722
ON/OFF 1 art. p 92 x l 117 x h 38	ON/OFF 1-2 art. p 115 x l 140 x h 50	ON/OFF 1-7 art. p 150 x l 60 x h 35	0/1-10V 1-7 art. p 150 x l 60 x h 35	DALI 1-6 art. p 191 x l 63 x h 38

Accessoires et câbles Pag. 763

Accessoires



description
98398 Clips de fixation
suitable for: Ice-cut66

RTG 96741W00

RTG 98398 / 99231 / 99232

Linear lights

Ice-Cut66_F | Linear profiles | 24V DC | topLED



6 W DC	Cct	lm S - D	Optic
Opaline 81255	M 2700	420 - 331	00 General -
	W 3000	438 - 344	
	N 4000	478 - 379	

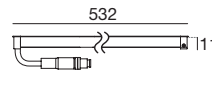

89179	89359	99331	99332	99722
ON/OFF 1-4 art. p 92 x l 117 x h 38	ON/OFF 1-8 art. p 115 x l 140 x h 50	ON/OFF 1-25 art. p 150 x l 60 x h 35	0/1-10V 1-25 art. p 150 x l 60 x h 35	DALI 1-20 art. p 191 x l 63 x h 38

12 W DC	Cct	lm S - D	Optic
Opaline 81256	M 2700	840 - 663	00 General -
	W 3000	875 - 689	
	N 4000	956 - 758	

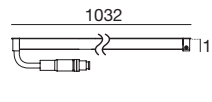

89179	89359	99331	99332	99722
ON/OFF 1-2 art. p 92 x l 117 x h 38	ON/OFF 1-4 art. p 115 x l 140 x h 50	ON/OFF 1-12 art. p 150 x l 60 x h 35	0/1-10V 1-12 art. p 150 x l 60 x h 35	DALI 1-10 art. p 191 x l 63 x h 38

18 W DC	Cct	lm S - D	Optic
Opaline 81257	M 2700	1260 - 995	00 General -
	W 3000	1313 - 1033	
	N 4000	1434 - 1137	

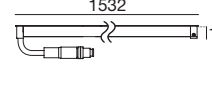

89179	89359	99331	99332	99722
ON/OFF 1 art. p 92 x l 117 x h 38	ON/OFF 1-2 art. p 115 x l 140 x h 50	ON/OFF 1-7 art. p 150 x l 60 x h 35	0/1-10V 1-7 art. p 150 x l 60 x h 35	DALI 1-6 art. p 191 x l 63 x h 38

Câbles Pag. 763

Câbles



24V DC
99231 Conn. F.4 pin M8 (L 1m)
suitable for: Ice-cut66 / Ice-cut66_F

Câbles d'extension



24V DC
99232 Conn M. + F. 4 pin M8 (L 1m)
suitable for: Ice-cut66 / Ice-cut66_F



skin

Matériaux

Corps en aluminium

Diffuseur en verre trempé



skin range

design Joerg Krewinkel



Skin_FL
Frameless Opaline



Skin_S
Surface



Skin_F
Frameless



Skin_Y
Asymmetric

2,1 W	166 x 57 mm	-	-	-
3,2 W	220 x 57 mm	-	-	-
6 W	-	166 x 57 mm	166 x 57 mm	-
9,6 W	-	166 x 57 mm	166 x 57 mm	-
10 W	-	220 x 57 mm	220 x 57 mm	-
12,2 W	-	-	-	220 x 57 mm
16,2 W	-	220 x 57 mm	220 x 57 mm	-
Finish	Black	Wh Bk	Black Bk Gold	Black
powerLED	-	2700K 3000K 4000K	2700K 3000K 4000K	2700K 3000K 4000K
topLED	2700K 3000K 4000K	-	-	-
Optics	General	Spot Food W.Flood	Spot Food W.Flood	Asymmetric
Driver	On/Off	On/Off	On/Off	On/Off

Skin est beau et fonctionnel

Skin est un appareil lumineux d'extérieur (IP67), versatile et modulable. Sa forme octogonale inédite allongée facilite la création de compositions linéaires continues permettant de suivre et d'illuminer, de par leur silhouette, les contours complexes ou non alignés de l'architecture contemporaine. Ce produit peut être utilisé dans différentes configurations : encastré au ras du sol, au mur ou au plafond, semi-encastré ou en saillie au plafond. La grande versatilité de Skin propose également des optiques contrôlant la luminance, disponibles dans plusieurs finitions. La structure aluminium en finition noire gaufrée, élégante et universelle, est parfaite dans tous les environnements. Les deux types de boîtiers d'encastré, l'un conçu pour l'installation au sol, l'autre pour l'installation au plafond, moulés ou en placoplâtre, contiennent un appareil lumineux à hautes performances, disponible en plusieurs sources et puissances.



Downlight
Encastré ou plafonnier
Cellules opalines
Verre sablé
Version 3/5 cellules



Downlight ou uplight
Encastré ou plafonnier
Cellules noires
Verre sérigraphié noir
Version 3/5 cellules



Downlight ou uplight
Encastré ou plafonnier
Cellules métallisées
Verre sérigraphié noir

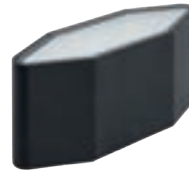

Downlight ou uplight
Encastré ou plafonnier
Verre opalin



Downlight ou uplight
Encastré ou plafonnier
Cellules dorées
Verre sérigraphié noir
Version 3/5 cellules

Flexibilité d'installation et mimétisme

Skin se prête à différentes solutions de configuration en comblant toutes les exigences d'un projet. Entre autres, la possibilité d'un semi-encastré laisse apparaître seulement l'épaisseur du verre, auquel vient s'ajouter l'émission d'une source lumineuse ponctuelle, douce diffusion de lumière vers la surface sur laquelle le poste est installé. Une solution d'une élégance absolue et d'une netteté formelle qui rend le produit presque invisible en ne laissant émerger que la lumière, matière essentielle pour la construction d'une architecture. Le diffuseur en verre est présenté en trois versions : avec peinture céramique pour un effet « path marker » intégrant un antidérapant, transparent avec optiques ou verre sablé pour la version semi-encastrée.



Optiques variées

Skin est disponible en 3 ou 5 sources (longueur : 166 et 220 mm) et différentes optiques : Spot, Flood et Wide Flood, Wall-Washer (éclairage rasant) asymétrique, et éclairage de signalisation avec diffuseur blanc antidérapant, dans des puissances qui vont de 2,1 à 16,2 W. Un ensemble technologique complet, pensé pour répondre à toutes les demandes des concepteurs de projet les plus exigeants.



Spot



Flood

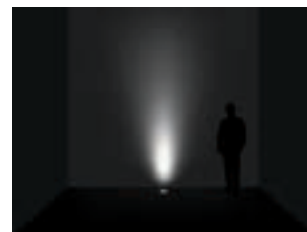

W.Flood

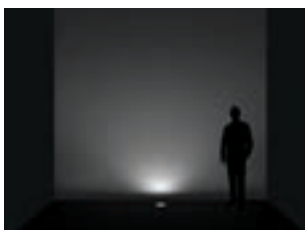

General

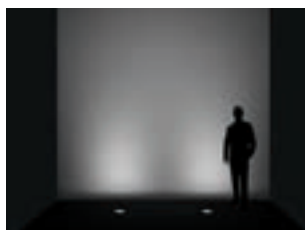

Asymmetric

Skin_FL | Lines | 176-276 V AC | topLED | 4 W D

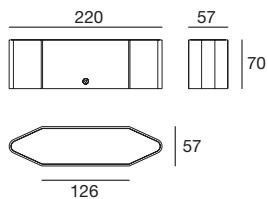

3,2 W DC - 3,8 W AC	Cct	lm S - D	Optic
Black 83872	M 2700	381 - On req	00 General -
	W 3000	399 - On req	
	N 4000	413 - On req	

Boîtier d'encastrement Pag. 769

Skin_F | Lines | 176-240 V AC | powerLEDs

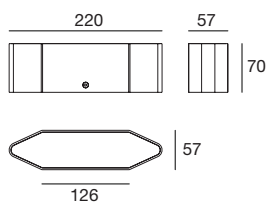

10 W DC - 11,2 W AC	Cct	lm S - D	Optic
Black 83869	M 2700	1330 - On req	15 Spot -
Bk Gold 83870	W 3000	1420 - On req	30 Flood -
	N 4000	1515 - On req	45 W.Flood -

16,2 W DC - 18 W AC	Cct	lm S - D	Optic
Black 83866	M 2700	2016 - On req	15 Spot -
Bk Gold 83867	W 3000	2016 - On req	30 Flood -
	N 4000	2177 - On req	45 W.Flood -

Boîtier d'encastrement Pag. 769

Skin_S | Lines | 176-240 V AC | powerLEDs

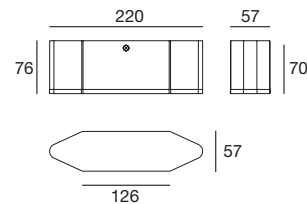

10 W DC - 11,2 W AC	Cct	lm S - D	Optic
Wh Bk 83871	M 2700	1330 - On req	15 Spot -
	W 3000	1420 - On req	30 Flood -
	N 4000	1515 - On req	45 W.Flood -

16,2 W DC - 18 W AC	Cct	lm S - D	Optic
Wh Bk 83868	M 2700	2016 - On req	15 Spot -
	W 3000	2016 - On req	30 Flood -
	N 4000	2177 - On req	45 W.Flood -

Boîtier d'encastrement Pag. 769

Skin_Y | Lines | 176-240 V AC | powerLEDs

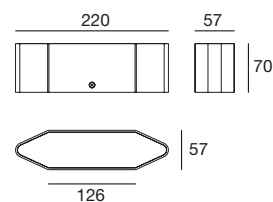

12,2 W DC - 14 W AC	Cct	lm S - D	Optic
Black 83873	M 2700	1584 - On req	07 Asymm. -
	W 3000	1700 - On req	
	N 4000	1834 - On req	

Boîtier d'encastrement Pag. 769

Skin_FL | Lines | 176-276 V AC | topLED | 2,1 W DC

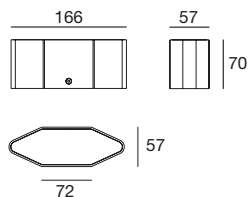

2,1 W DC - 2,5 W AC	Cct	lm S - D	Optic
Black 83865	M 2700	254 - On req	00 General -
	W 3000	266 - On req	
	N 4000	275 - On req	

Boîtier d'encastrement Pag. 769

Skin_F | Lines | 176-276 V AC | powerLEDs

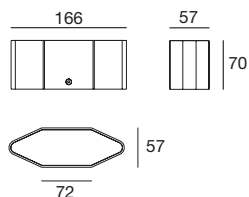

6 W DC - 6,7 W AC	Cct	lm S - D	Optic
Black 83859	M 2700	798 - On req	15 Spot -
Bk Gold 83860	W 3000	852 - On req	30 Flood -
	N 4000	909 - On req	45 W.Flood -

9,6 W DC - 11 W AC	Cct	lm S - D	Optic
Black 83862	M 2700	1210 - On req	15 Spot -
Bk Gold 83863	W 3000	1210 - On req	30 Flood -
	N 4000	1306 - On req	45 W.Flood -

Boîtier d'encastrement Pag. 769

Skin_S | Lines | 176-276 V AC | powerLEDs

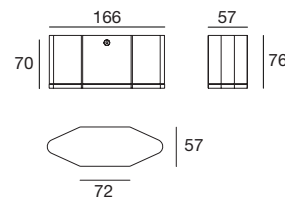

6 W DC - 6,7 W AC	Cct	lm S - D	Optic
Wh Bk 83864	M 2700	798 - On req	15 Spot -
	W 3000	852 - On req	30 Flood -
	N 4000	909 - On req	45 W.Flood -

9,6 W DC - 11 W AC	Cct	lm S - D	Optic
Wh Bk 83861	M 2700	1210 - On req	15 Spot -
	W 3000	1210 - On req	30 Flood -
	N 4000	1306 - On req	45 W.Flood -

Boîtier d'encastrement Pag. 769

Boîtier d'encastrement



Recessed casing for concrete

description

83123 Boîtier d'encastrement 175 mm
suitable for: Skin 166 mm

83124 Boîtier d'encastrement 229 mm
suitable for: Skin 220mm



Recessed casing for plasterboard ceilings

description

83125 Boîtier d'encastrement 175 mm
suitable for: Skin 166 mm

83126 Boîtier d'encastrement 229 mm
suitable for: Skin 220mm

dirigo

Materials

Corps en aluminium ou en inox AISI 316L



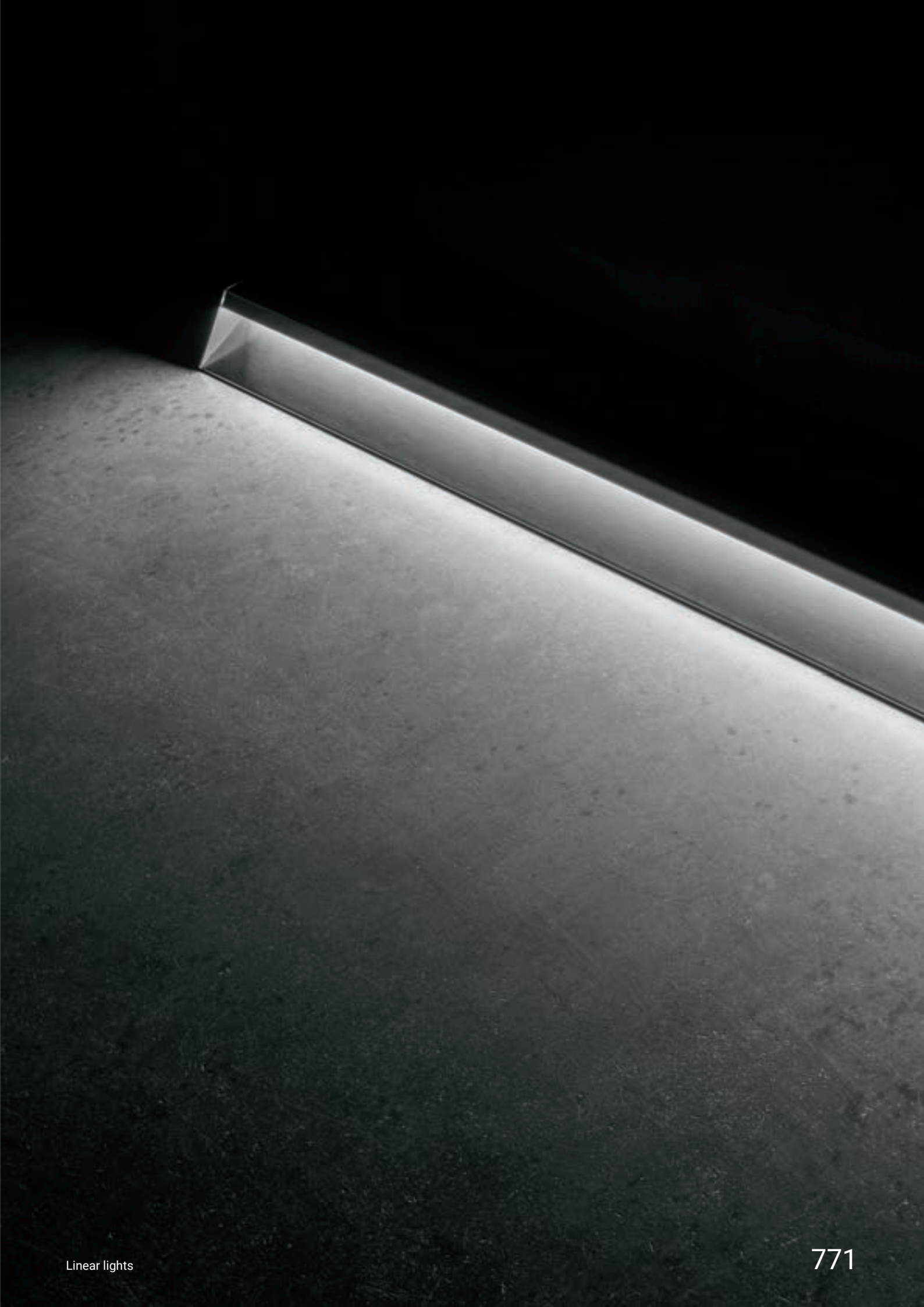

dirigo

design Rigo Architeti

Concept

Invisible le jour. Protagoniste absolu de nuit. Dirigo crée des parcours de lumière à travers un jeu subtil de plans qui dissimulent la source. La section particulière du profil rend le produit compact et robuste, en s'adaptant parfaitement aux plus différents contextes en extérieur.

Technologie et matériaux

Le Dirigo est disponible en versions dédiées en Acier Inoxydable AISI 316L brossé ou en aluminium extrudé anodisé, avec traitement antioxydant pré-laquage à poudre polyester.



Lumière rasante

L'inclinaison interne de la source LED a été conçue pour une distribution optimale de la lumière le long des parcours.

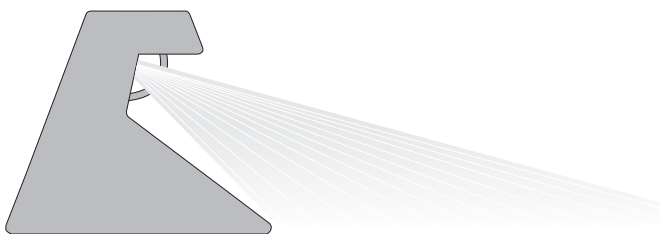

Gamme

Dirigo est disponible comme élément simple ou prévu pour une installation en ligne continue.

Modules individuels (L. 1 m)

Profil fermé doté d'une unité lumineuse, bouchons terminaux, driver 24V DC intégré.

Modules pour installation en ligne continue (L. 1 m)

Profils coupés sur mesure prévus pour une ligne continue jusqu'à 5/10 m. Unité lumineuse LED disponible comme code séparé et pouvant être coupée sur mesure. Joints mécaniques de connexion entre les profils. Driver à distance 24 V DC.



Version élément complet



Système

Design robuste

La structure de plans opposés qui caractérise le profil unique de Dirigo rend l'appareil extrêmement robuste et résistant. L'absence d'angles droits est idéale pour l'application dans des espaces extérieurs, publics et privés. Dirigo est piétinable et garantit une sécurité maximale pour les utilisateurs.

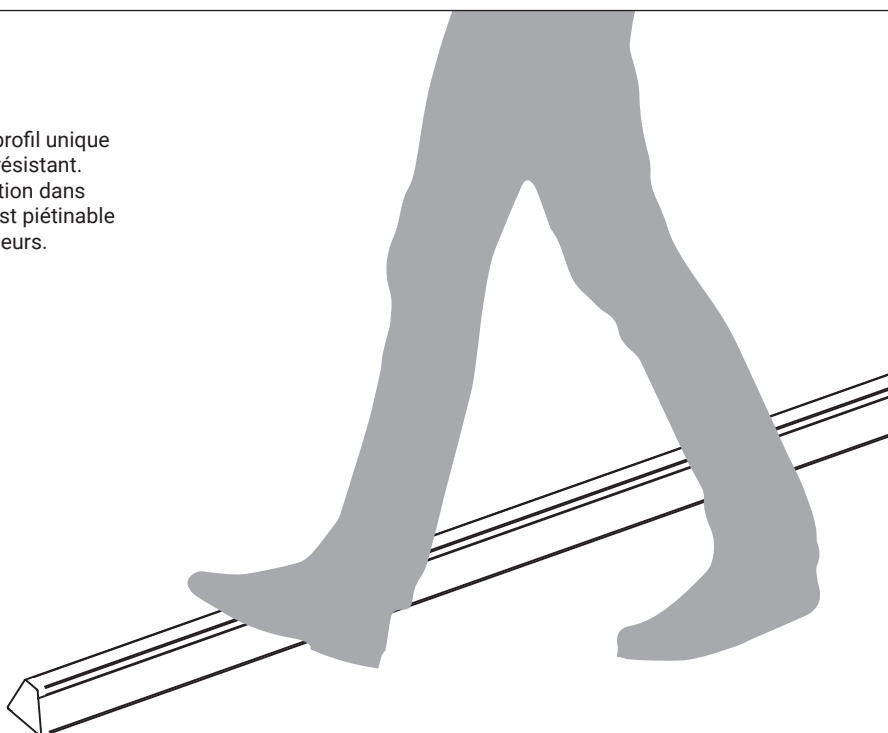

Dirigo_M2 Aluminium MASTER | Linear profiles

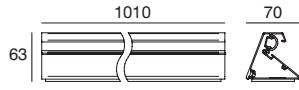
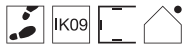

BK Grey	64645
Grey	64644
DarkBrown	64595

Master



À compléter avec des accessoires d'installation dédiés et des unités d'éclairage

Dirigo_M2 Aluminium SLAVE | Linear profiles

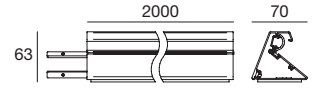
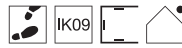

BK Grey	64647
Grey	64646
DarkBrown	64597

Slave



À compléter avec des accessoires d'installation dédiés et des unités d'éclairage

Dirigo_M2 Aluminium IN-corner | Linear profiles

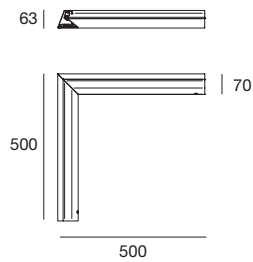
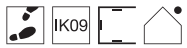

BK Grey	64664
Grey	64665
DarkBrown	64666

À compléter avec des accessoires d'installation dédiés et des unités d'éclairage

Dirigo_M2 Aluminium OUT-corner | Linear profiles

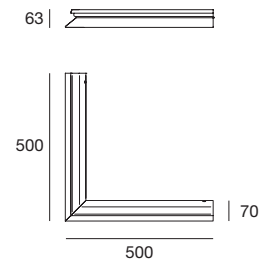
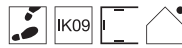

BK Grey	64667
Grey	64668
DarkBrown	64669

À compléter avec des accessoires d'installation dédiés et des unités d'éclairage

Dirigo Sealing caps | Linear profiles

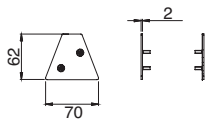

BK Grey	64641
Grey	64640
DarkBrown	64589
Steel	64592

Dirigo Joining caps | Linear profiles

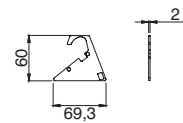

BK Grey	64661
Grey	64663
DarkBrown	64662
Steel	64593

Accessoires et configuration

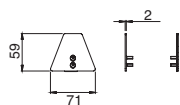

64592
Bouchons de fermeture
 Aluminium
 2 pcs

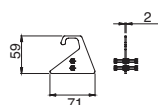

64593
Bouchons de jonction
 Aluminium
 5 pc

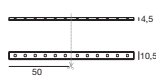

62403 (Pag. 909)
Unité lumineuse
 Led strip 14,4 W/m
 3000K
 5 mt



89629
Câble de connexion
 2 mt



99000
Rallonge
 2 mt

62403N (Pag. 909)
Unité lumineuse
 Led strip 14,4 W/m
 4000K
 5 mt

Électronique

99374	99331	99332	83062	99787
ON/OFF 75 W p 210 x l 148 x h 25	ON/OFF 150 W p 150 x l 60 x h 35	0/1-10V 150 W p 150 x l 60 x h 35	DALI 120 W p 191 x l 63 x h 38	DALI 120 W p 244 x l 71 x h 38

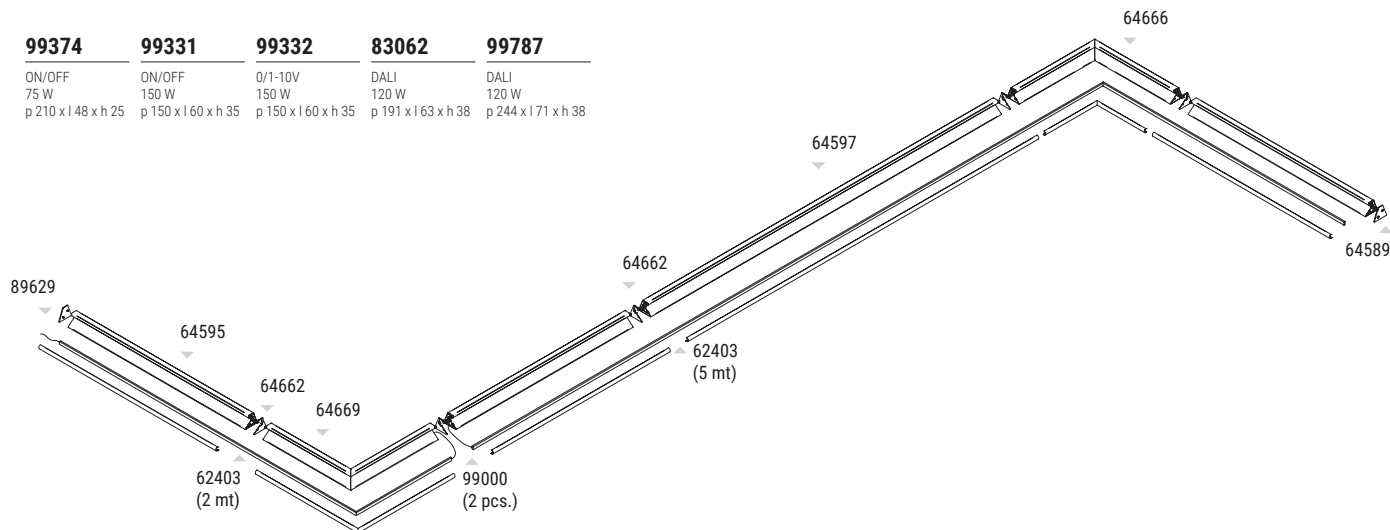

Dirigo_FL2 Aluminium | Linear profiles | 100-264 V AC | stripLED 14,4 W DC 17 W AC

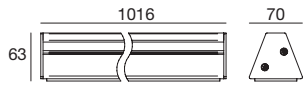

	Cct	lm S - D	Optic
BK Grey 64643	W 3000	900 - 384	00 General (127°)
Grey 64642			
DarkBrown 64594			

Dirigo_FL1 Steel | Linear profiles | 100-264 V AC | stripLED 14,4 W DC 17 W AC

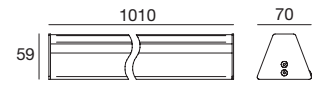

	Cct	lm S - D	Optic
Steel 64590	W 3000	900 - 450	00 General (127°)

Private house | Spain



Dirigo_M1 Steel MASTER | Linear profiles

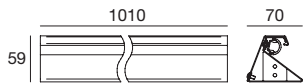

Steel **64591**

Master



À compléter avec des accessoires d'installation dédiés et des unités d'éclairage

Dirigo_M1 Steel SLAVE | Linear profiles

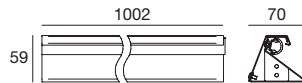

Steel **64648**

Slave



À compléter avec des accessoires d'installation dédiés et des unités d'éclairage

Accessoires et configuration

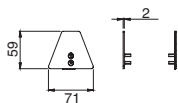

64592
Bouchons de fermeture
Acier inoxydable
2 pcs

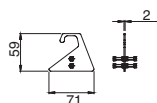

64593
Bouchons de jonction
Acier inoxydable
1 pc

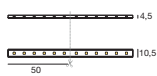

62403 (Pag. 909)
Unité lumineuse
Led strip 14,4 W/m
3000K
5 mt



89629
Câble de connexion
2 mt



99000
Rallonge
2 mt

62403N (Pag. 909)
Unité lumineuse
Led strip 14,4 W/m
4000K
5 mt

Électronique

99374	99331	99332	83062	99787
ON/OFF 75 W p 210 x l 48 x h 25	ON/OFF 150 W p 150 x l 60 x h 35	0/1-10V 150 W p 150 x l 60 x h 35	DALI 120 W p 191 x l 63 x h 38	DALI 120 W p 244 x l 71 x h 38

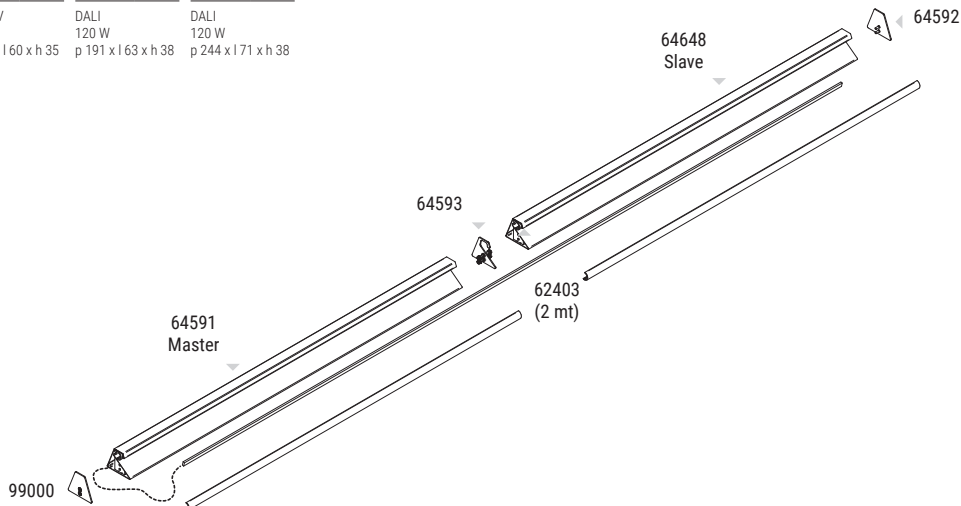



fylo+

Matériaux

Profilé en aluminium

Résines en poudre de quartz et matériau
de construction mélangé



fylo+ outdoor range



Recessed



Length	1000 mm 2000 mm Custom 1100 - 1900 mm (minimum 100 mm unit)
LED source	StripLED
Driver	On/Off 0/1-10V DALI

Procédure d'installation

Les nouveaux modules Fylo+ Out maintiennent le même aspect esthétique des versions précédentes. Dès qu'ils sont installés, les profils disparaissent en se fondant complètement avec l'architecture qui les entourent; le concept de lumière intégrée permet de personnaliser les espaces avec des détails de lumière inédits et précieux.

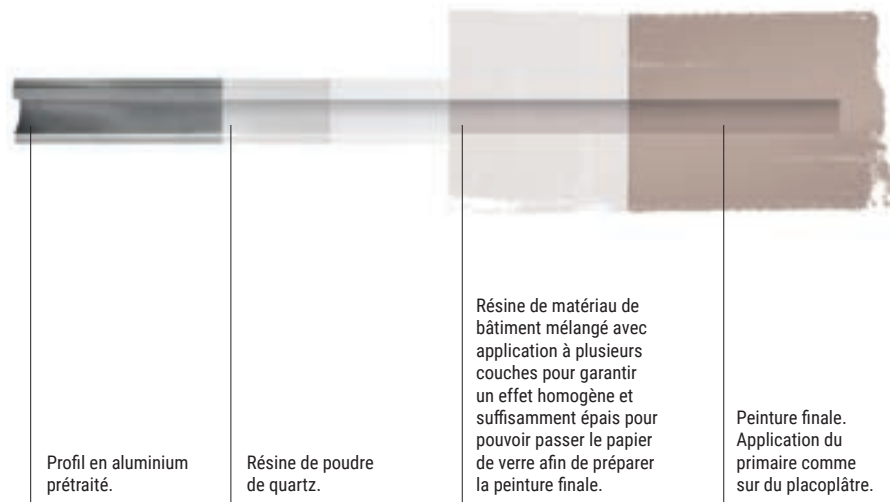

Intégration totale dans le mur

Sa résistance élevée aux agents climatiques permet d'installer Fylo+ Out en toute sécurité. Les matériaux et la qualité de fabrication sont des garanties de la fiabilité.

- Effectuer un creux dans la maçonnerie.
- Insérer le boîtier d'encastrement en EPS.
- Bloquer le boîtier d'encastrement en EPS avec de l'enduit au ciment.
- Enlever le boîtier d'encastrement et disposer le câble d'alimentation.
- Insérer le profil dans le logement précédemment créé.
- Compléter l'installation avec différentes couches d'enduit en vérifiant que le filet adhère à la première couche. Ensuite, insérer la source LED et effectuer le raccordement électrique.

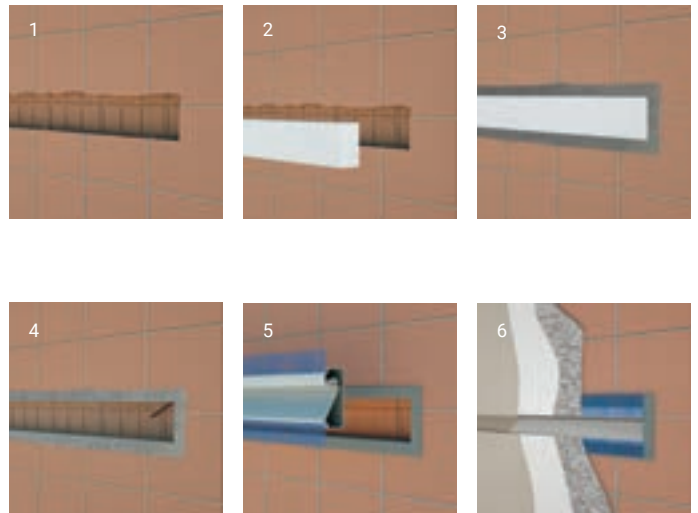

Intégration totale dans le revêtement

- Couper le mur-manteau d'isolation thermique afin d'aménager le logement pour le profil.
- Mettre de la colle polyuréthane sur le côté arrière du profil et l'insérer dans le logement en faisant attention à faire passer les câbles d'alimentation. Placer éventuellement des bouchons de fermeture.
- Passer la première couche de colle, positionner le filet en excluant la partie en relief du profil, passer les couches successives de colle, puis passer l'enduit.
- À la fin, insérer la source LED dans le bloc optique approprié et effectuer le raccordement électrique.

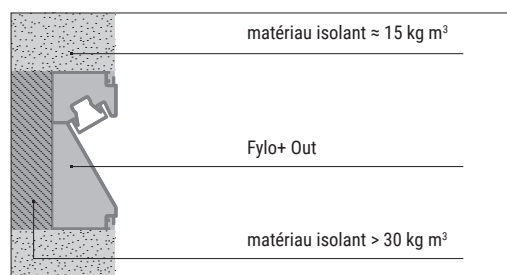

*Il est conseillé de choisir un matériau isolant ayant une densité au moins deux fois supérieure à celui du revêtement utilisé comme surface d'appui pour Fylo+ Out, afin d'augmenter l'isolation thermique.

Fylo+ Out Recessed_S | Recessed light body

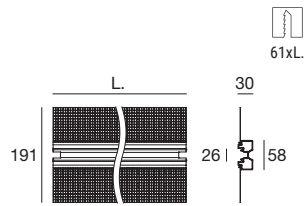
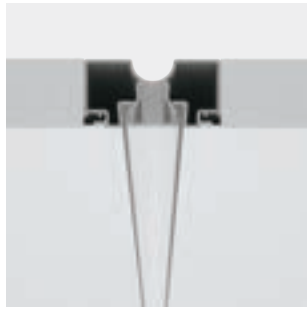

	L mm
Primer 65036	1000
Primer 65037	2000
Primer 65090*	custom

Les modules doivent être complétés par une source de lumière et une alimentation.

*En sélectionnant le code « Custom », il est possible de commander la longueur de profilé souhaitée, d'un minimum de 1,1 m à un maximum de 1,9 m.
Par exemple : pour obtenir 1,3 m de Fylo+, il suffit de commander 1,3 x 65090.

Accessoires Pag. 783

RTG 65037

Fylo+ Out Recessed_W | Recessed light body

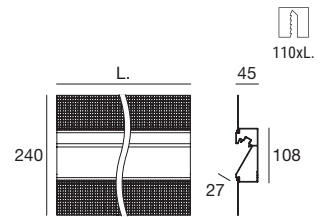

	L mm
Primer 65039	1000
Primer 65040	2000
Primer 65093*	custom

Les modules doivent être complétés par une source de lumière et une alimentation.

*En sélectionnant le code « Custom », il est possible de commander la longueur de profilé souhaitée, d'un minimum de 1,1 m à un maximum de 1,9 m.
Par exemple : pour obtenir 1,3 m de Fylo+, il suffit de commander 1,3 x 65093.

Accessoires Pag. 783

RTG 65039 / 65040

Silicone_F 120 LEDs/m | stripLED | 9.6 W/m 24 V

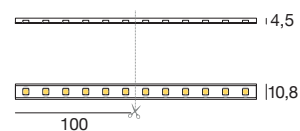
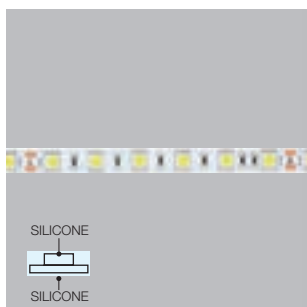

	Cct	lm S - D
62761 5 m	M 2700	2070 - On req

Strip suggested for Fylo+ Out article

Électronique

99374	99331	99332	83062	99787
ON/OFF 75 W p 210 x l 148 x h 25	ON/OFF 150 W p 150 x l 60 x h 35	0/1-10V 150 W p 150 x l 60 x h 35	DALI 120 W p 191 x l 63 x h 38	DALI 120 W p 244 x l 71 x h 38

RTG 62761

Accessoires

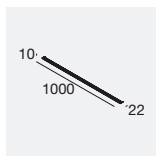

description
62757 Diffuseur opalin
suitable for: Fylo+ Out Recessed_S
 Fylo+ Out Recessed_W

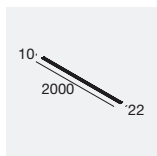

description
62758 Diffuseur opalin
suitable for: Fylo+ Out Recessed_S
 Fylo+ Out Recessed_W

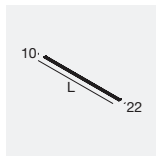

description
65094 Diffuseur opalin (custom)
suitable for: Fylo+ Out Recessed_S
 Fylo+ Out Recessed_W

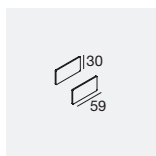

description
65026 Bouchons de fermeture
suitable for: Fylo+ Out Recessed_S



description
65023 Bouchons de fermeture
suitable for: Fylo+ Out Recessed_W

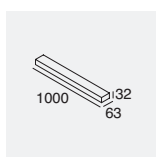

description
65035 Template
suitable for: Fylo+ Out Recessed_S

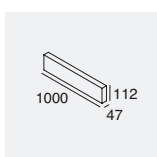

description
65038 Template
suitable for: Fylo+ Out Recessed_W

RTG 65094 / 62758 / 65035 / 65038 / 62757 / 65026 / 65023

Private residence | Italy

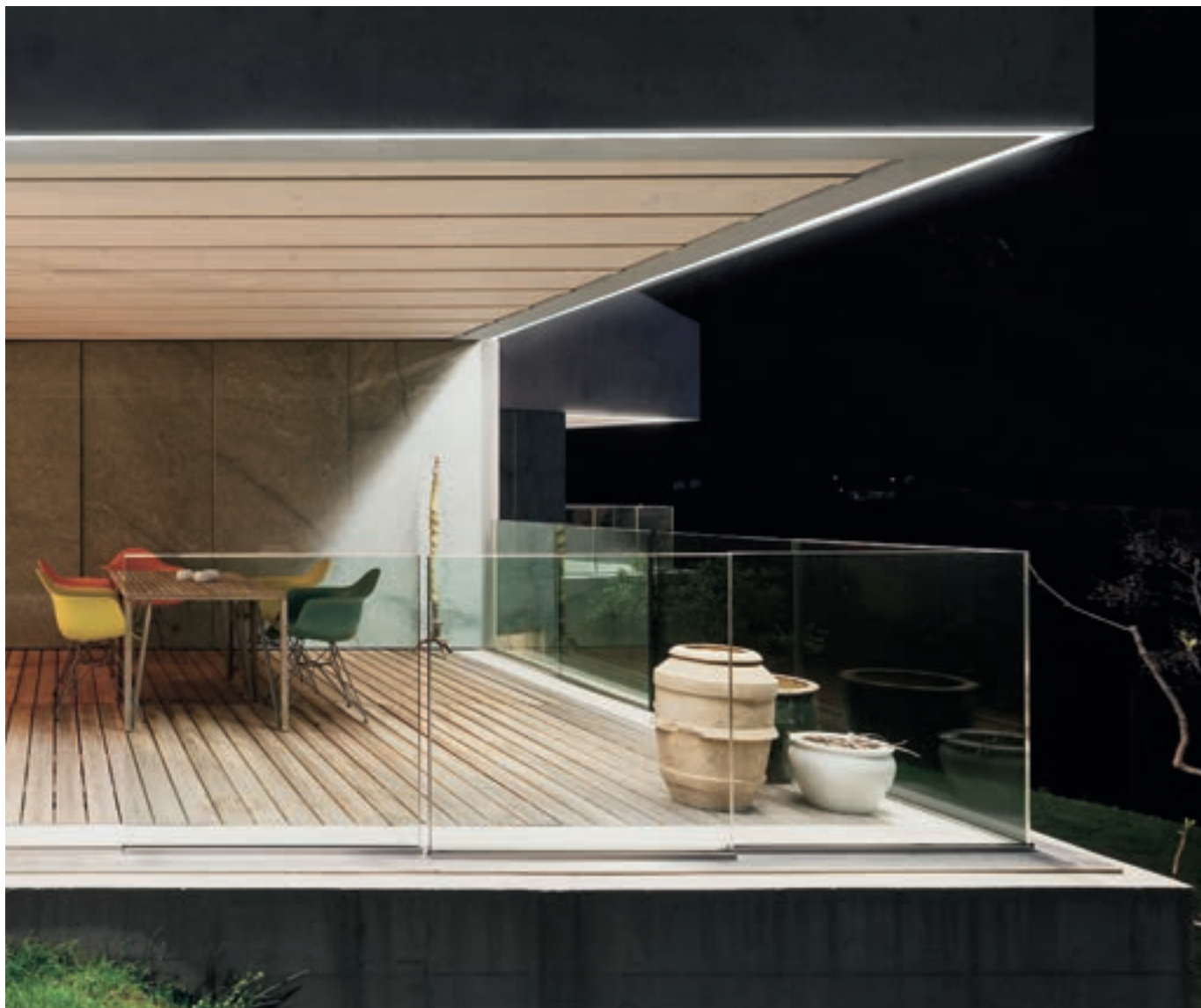

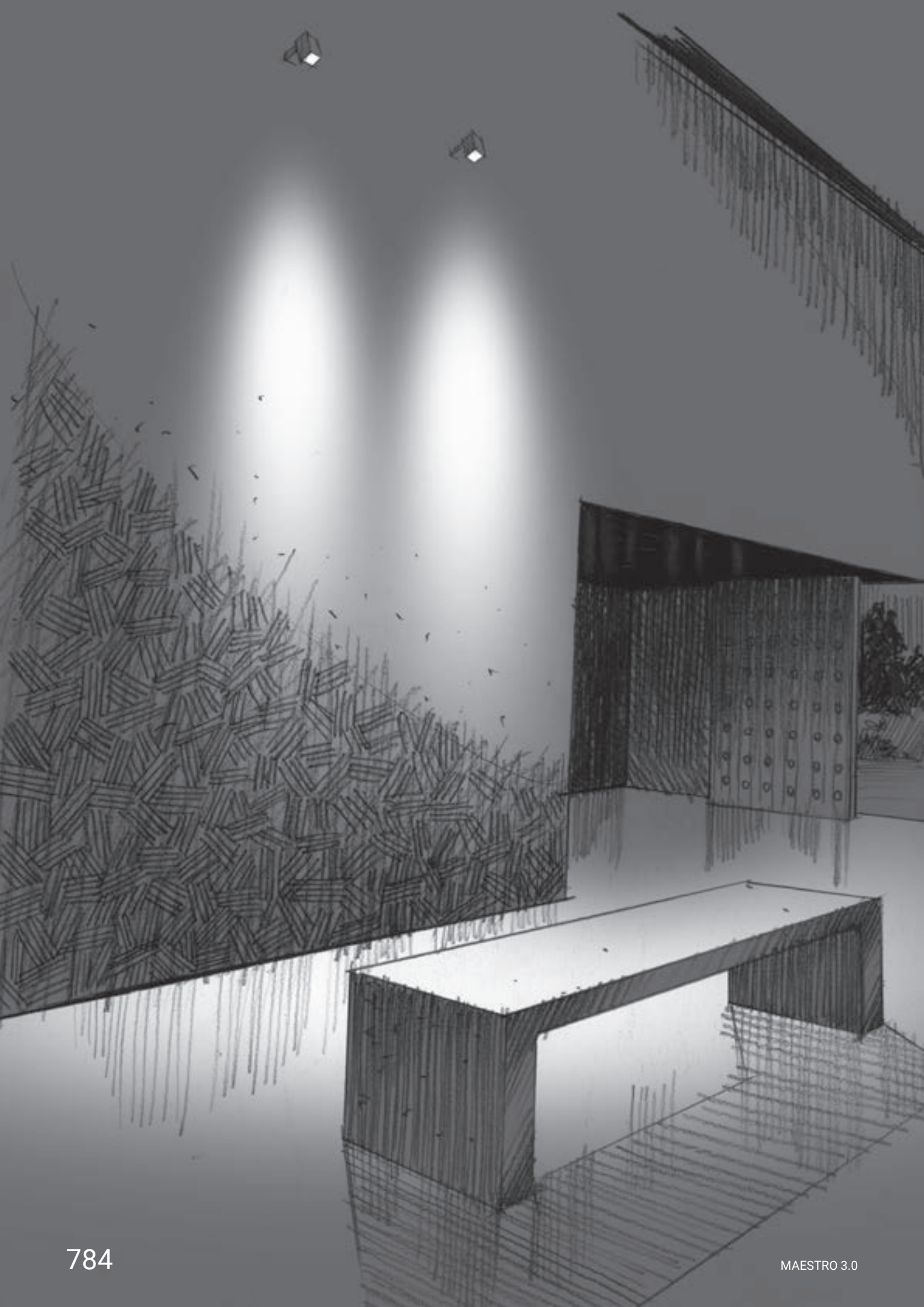

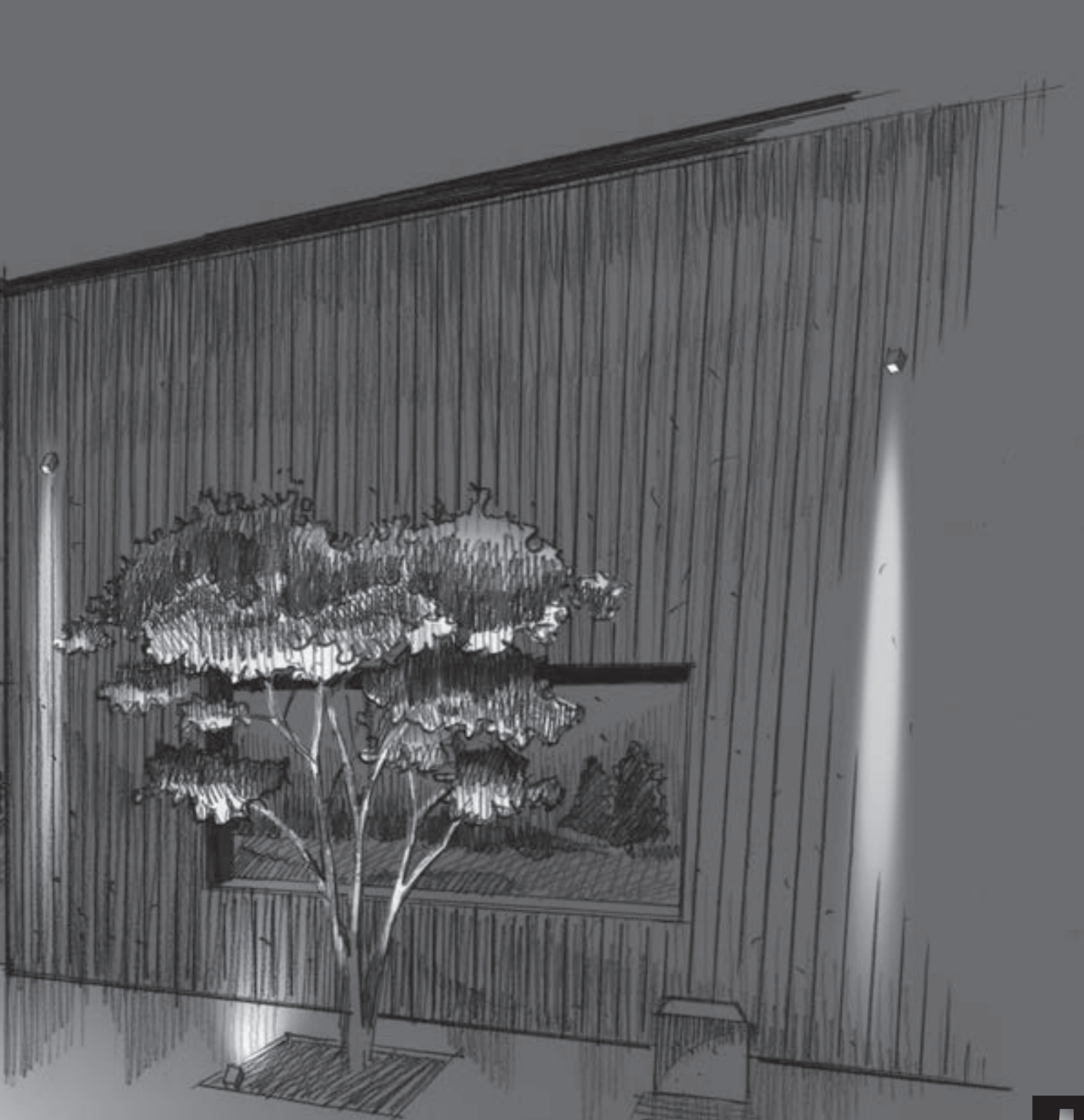

Accent lighting

accent lighting range index

Eyelet65

Eyelet65_R



789

Eyelet65_Q



789

Periskop

Periskop

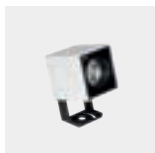

794

Periskop Narrow



794

Shaker

Shaker

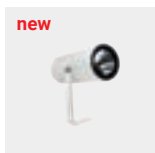

801

Gardener

Gardener

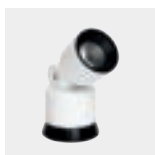

804

Narcissus

Narcissus



807

Clivo

Clivo

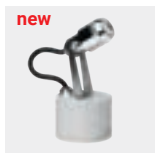

811

Clivo_2

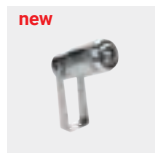

811

Clivo_SL



811

Iris67

Iris67

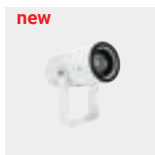

814

Iris67 Elliptic

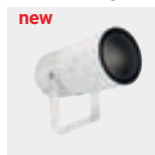

815

Vuelta

Vuelta_Y

Vuelta



817



817

Prolamp

Prolamp

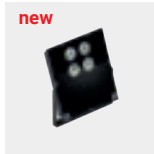

820

Archiline

Archiline Twin



823

eyelet65

Matériaux
Corps en aluminium



Eyelet65_R | Accent lighting | powerLED 2 W DC 630 mA

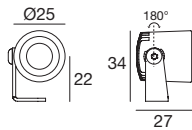
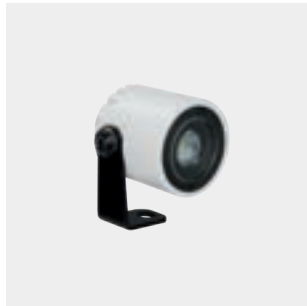

		Cct	lm S - D	Optic
White	91214	M 2700	219 - 171	15 Spot (12°)
Black	91215	W 3000	233 - 183	30 Flood (26°)
Grey	91216	N 4000	249 - 208	60 Wide Flood (51°)

Électronique

89420	99179	99186	83102
ON/OFF 1 - 2 art. p 65 x l 74 x h 27	ON/OFF 3 - 6 art. p 80 x l 100 x h 31	ON/OFF 6 - 12 art. p 92 x l 117 x h 38	DALI 1 - 14 art. p 54 x l 121 x h 26

Accessoires Pag. 789

RTG 91214W30 / 91215M30 / 91215M60 / 91215W15
91215W30 / 91215W60 / 91216W30 / 91216W60

Eyelet65_Q | Accent lighting | powerLED 2 W DC 630 mA

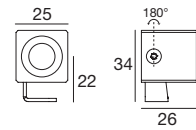

		Cct	lm S - D	Optic
White	91217	M 2700	219 - 152	15 Spot (12°)
Black	91219	W 3000	233 - 171	30 Flood (26°)
Grey	91220	N 4000	249 - 183	60 Wide Flood (51°)

Électronique

89420	99179	99186	83102
ON/OFF 1 - 2 art. p 65 x l 74 x h 27	ON/OFF 3 - 6 art. p 80 x l 100 x h 31	ON/OFF 6 - 12 art. p 92 x l 117 x h 38	DALI 1 - 14 art. p 54 x l 121 x h 26

Accessoires Pag. 789

RTG 91219W30 / 91219W60 / 91220W30 / 91220W60



Eyelet65 avec accessoire Snoot intégré

Accessoires



	description
98624	Piquet en acier 160 mm
suitable for: Eyelet65_R / Eyelet65_Q	



	description
98669	Piquet en acier 101 mm
suitable for: Eyelet65_R / Eyelet65_Q	



	description
99746	Snoot
suitable for: Eyelet65_R / Eyelet65_Q	



	description
84992	Wrench for installing the Snoot
suitable for: Eyelet65_R / Eyelet65_Q	

periskop

Matériaux

Corps en aluminium

Diffuseur en verre trempé extra-clair





periskop range

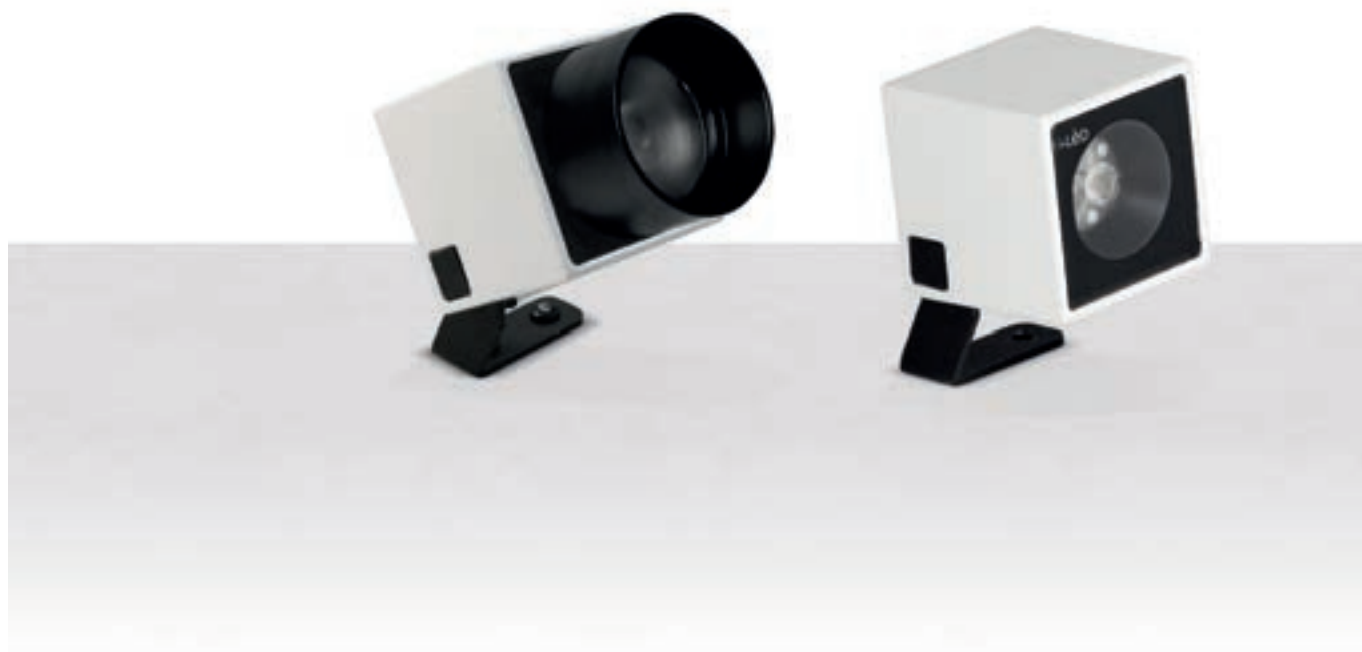

	Periskop	Periskop Narrow
4,5 W	□ 46 mm RGB	-
6 W - 6,5 W	□ 46 mm - □ 76 mm	□ 46 mm
8 W	□ 76 mm RGBW	□ 76 mm
9 W	-	-
18 W	□ 110 mm - □ 110 mm RGBW	□ 110 mm
30 W	□ 162 mm	-
37 W	□ 162 mm RGBW	-
42 W	□ 162 mm	-
46 W	□ 162 mm	□ 162 mm
Accessories		
Optics	Spot - Narrow Spot - Flood - Wide Flood	Spot - Narrow Spot
Finish	<input type="checkbox"/> White <input checked="" type="checkbox"/> Black <input type="checkbox"/> Grey <input type="checkbox"/> DarkBrown	<input type="checkbox"/> White <input checked="" type="checkbox"/> Black <input type="checkbox"/> Grey <input type="checkbox"/> DarkBrown
Cct	2700K - 3000K 4000K - RGB - RGBW	2700K - 3000K 4000K
Control	On/Off - DALI	On/Off - DALI

periskop accessories

Accessoires externes - Anti-éblouissement

Les accessoires anti-éblouissement sont conçus pour réduire l'éblouissement lumineux. Ces accessoires sont en aluminium finition noire.

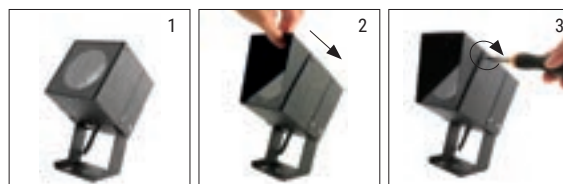
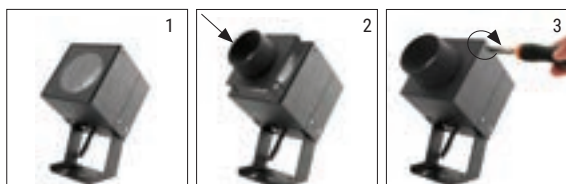

Accessoires internes - Honeycomb louvre et filtre elliptique

L'accessoire Honeycomb louvre est conçu pour réduire l'éblouissement lumineux. Le filtre elliptique permet de créer des projections ovalisées. Disponible uniquement sur demande.



81168W08

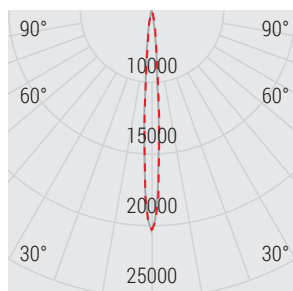

Courbe photométrique

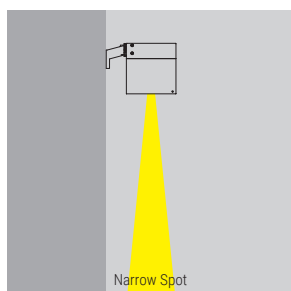

Faisceau lumineux

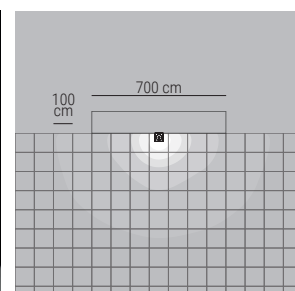
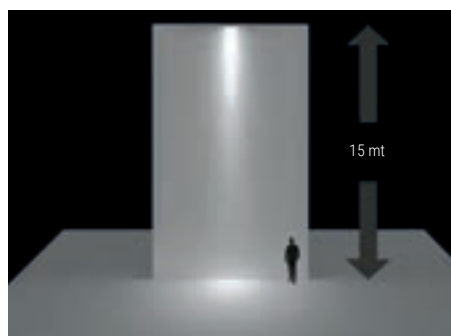

Planimétrie

Periskop | Accent lighting | powerLED 6 W DC 500 mA

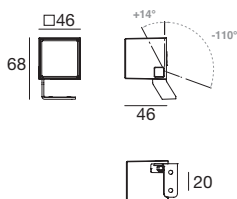

		Cct	lm S - D	Optic
White	90519	M 2700	659 - 396	15 Spot (14°)
Black	90520	W 3000	659 - 396	30 Flood (28°)
Grey	90521	N 4000	711 - 427	60 W.Flood (49°)
DarkBrown	90522			

Électronique

99181	99185	83101
ON/OFF 1 art.	ON/OFF 2 - 3 art.	DALI 1 - 4 art.
p 80 x l 100 x h 31	p 92 x l 117 x h 38	p 54 x l 121 x h 26

Accessoires Pag. 799

RTG 90521W30 / 90520W30 / 90520W60 / 90522W30 / 90522W60

Periskop RGB | Accent lighting | powerLED 4,5 W DC 500 mA

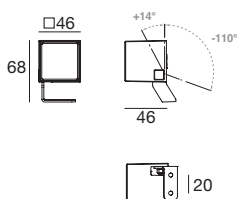

		Z RGB	Optic
White	95068		15 Spot -
Black	95126		60 W.Flood -
Grey	95141		
DarkBrown	95330		

Électronique

99742 + 99702	99333	DMX	Driver	Switching
Dimmer RF 1 - 12 art.	Dimmer DMX 2 - 12 art.	Contrrollers CV 24V/48V Pag. 952 - 953	CV 48V Pag. 941	CV 48V Pag. 932

Accessoires Pag. 799

RTG 95141Z15

Periskop Narrow | Accent lighting | powerLED 6 W DC 500 mA

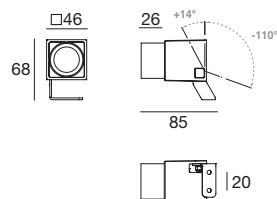
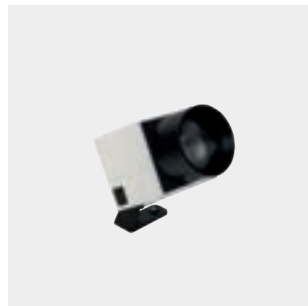

		Cct	lm S - D	Optic
White	81788	M 2700	659 - 487	08 Spot (11°)
Black	81789	W 3000	659 - 487	
Grey	81790	N 4000	711 - 524	
DarkBrown	81791			

Électronique

99181	99185	83101
ON/OFF 1 art.	ON/OFF 2 - 3 art.	DALI 1 - 4 art.
p 80 x l 100 x h 31	p 92 x l 117 x h 38	p 54 x l 121 x h 26

Accessoires Pag. 799

Periskop | 198-264 V AC | Accent lighting | arrayLED 6,5 W DC - 8 W AC

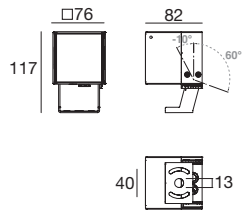
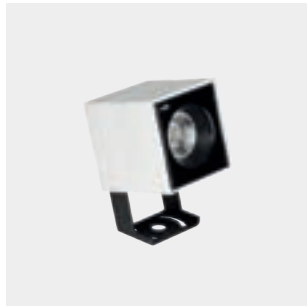

		Cct	lm S - D	Optic
White	95346	M 2700	770 - 557	15 Spot (15°)
Black	95347	W 3000	770 - 597	30 Flood (37°)
Grey	95348	N 4000	831 - 645	60 W.Flood (62°)
DarkBrown	95349			

Accessoires Pag. 799

RTG 95347W30 / 95348W30 / 95349W30

Periskop Narrow | 198-264 V AC | Accent lighting | powerLED 8 W DC - 10 W AC

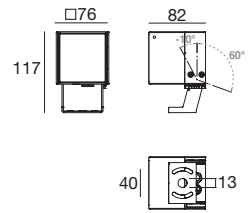

		Cct	lm S - D	Optic
White	81160	M 2700	854 - 588	08 N.Spot (6°)
Black	81161	W 3000	854 - 588	
Grey	81162	N 4000	922 - 635	
DarkBrown	81163			

Accessoires Pag. 799

Periskop RGBW | Accent lighting | powerLED 8 W DC 630 mA

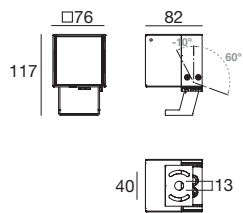

			Optic
White	81493	Q RGBW natural white	06 N.Spot -
Black	81494	V RGBW warm white	15 Flood -
Grey	81495		45 W.Flood -
DarkBrown	81496		

Électronique

99743 + 99702	99333	DMX	Driver	Switching
Dimmer RF 1 - 12 art.	Dimmer DMX 2 - 12 art.	DMX Controllers CV 24V/48V Pag. 952 - 953	Driver CV 48V Pag. 941	Switching CV 48V Pag. 932

Accessoires Pag. 799

Periskop | 198-264 V AC | Accent lighting | arrayLED 18 W DC - 20 W AC

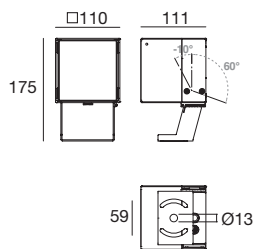

		Cct	lm S - D	Optic
White	95366	M 2700	2349 - 1700	15 Spot (17°)
Black	95368	W 3000	2510 - 1818	30 Flood (34°)
Grey	95370	N 4000	2510 - 1970	60 W.Flood (63°)
DarkBrown	95378			

Accessoires Pag. 799

Periskop Narrow | 198-264 V AC | Accent lighting | 3 x powerLEDs 18 W DC - 20 W AC

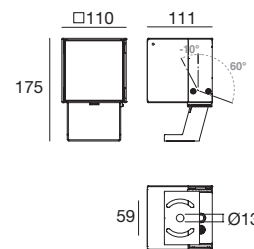

		Cct	lm S - D	Optic
White	81164	M 2700	1977 - 1452	08 N.Spot (8°)
Black	81165	W 3000	1977 - 1452	
Grey	81166	N 4000	2133 - 1567	
DarkBrown	81167			

Accessoires Pag. 799

Periskop RGBW | Accent lighting | arrayLED 18 W DC 500 mA

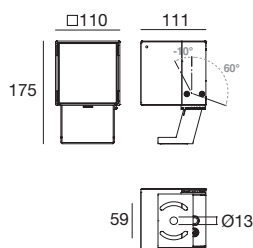

			Optic
White	81497	V RGBW warm white	15 Spot -
Black	81498		30 Flood -
Grey	81499		60 W.Flood -
DarkBrown	81500		

Électronique

99742 + 99702	99333	DMX	Driver	Switching
Dimmer RF 1 - 4 art.	Dimmer DMX 1 - 4 art.	Controllers Pag. 952 - 953	CV 48V Pag. 941	CV 48V Pag. 932

Accessoires Pag. 799



Periskop | 198-264 V AC | Accent lighting | arrayLED

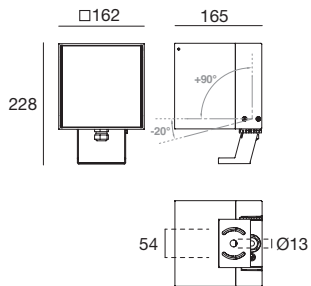

30 W DC - 33 W AC		Cct	lm S - D	Optic
White	81367	M 2700	3991 - 3272	20 Spot (20°)
Black	81368	W 3000	4270 - 3501	30 Flood (27°)
Grey	81369	N 4000	4588 - 3762	60 W.Flood (51°)
DarkBrown	81370			

46 W DC - 50 W AC		Cct	lm S - D	Optic
White	80383	M 2700	6153 - 4538	20 Flood (26°)
Black	80384	W 3000	6153 - 4538	30 Flood (30°)
Grey	80385	N 4000	7074 - 5218	60 W.Flood (51°)
DarkBrown	80386			

Accessoires Pag. 799

Periskop | 100-277 V AC | Accent lighting | arrayLED

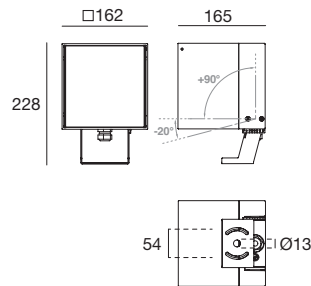

30 W DC - 33 W AC		Cct	lm S - D	Optic
White	81542	M 2700	3991 - 3272	20 Spot (20°)
Black	81543	W 3000	4270 - 3501	30 Flood (27°)
Grey	81544	N 4000	4588 - 3762	60 W.Flood (51°)
DarkBrown	81545			

42 W DC - 46 W AC		Cct	lm S - D	Optic
White	81546	M 2700	5953 - 4389	20 Spot (25°)
Black	81547	W 3000	5953 - 4389	30 Flood (30°)
Grey	81548	N 4000	6845 - 5049	60 W.Flood (51°)
DarkBrown	81549			

Accessoires Pag. 799

Periskop Narrow | 198-264 V AC | Accent lighting | 9 x powerLEDs 46 W DC - 50 W AC

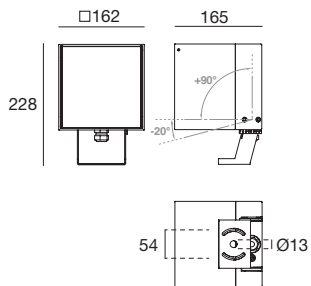

		Cct	lm S - D	Optic
White	81168	M 2700	5243 - 1452	08 N.Spot (7°)
Black	81169	W 3000	5243 - 1452	
Grey	81170	N 4000	5660 - 1567	
DarkBrown	81171			

Accessoires Pag. 799

Periskop RGBW | 99-264 V AC | Accent lighting | arrayLED 37 W DC - 40 W AC

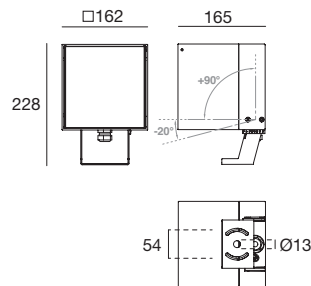

		V	Optic
White	81784	RGBW warm white	15 Spot -
Black	81785		30 Flood -
Grey	81786		60 W.Flood -
DarkBrown	81787		

Électronique

DMX DMX controllers Pag. 952 - 953	99385 DMX/RDM addresser	98986 DMX LINE Clouser 120 Ohm	98985/99390 Splitter ALLinONE Start & Continuity Pag. 956
---	--------------------------------------	---	---

Accessoires Pag. 799

Accessoires



description

98624 Piquet en acier 160 mm

suitable for: Periskop 46mm / Periskop Narrow 46mm
Periskop RGB 46mm

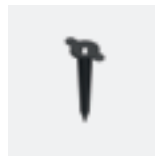

description

98549 Piquet

suitable for: Periskop 76/110/162mm
Periskop Narrow 76/110/162mm
Periskop RGBW 76/110/162mm

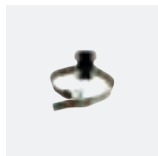

description

99802 Ceinture pour arbre

suitable for: Periskop / Periskop Narrow
Periskop RGB / Periskop RGBW

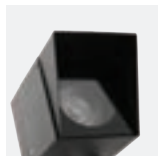

description

98966 Écran anti-éblouissement

suitable for: Periskop 76mm / Periskop Narrow 76mm
Periskop RGBW 76mm

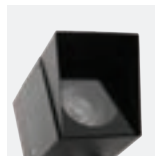

description

98967 Écran anti-éblouissement

suitable for: Periskop 110mm / Periskop Narrow 110mm
Periskop RGBW 110mm

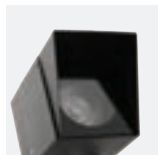

description

98968 Écran anti-éblouissement

suitable for: Periskop 162mm / Periskop Narrow 162mm
Periskop RGBW 162mm



description

98969 Tube anti-éblouissement

suitable for: Periskop 76mm / Periskop RGBW 76mm



description

98970 Tube anti-éblouissement

suitable for: Periskop 110mm / Periskop RGBW 110mm



description

98971 Tube anti-éblouissement

suitable for: Periskop 162mm / Periskop RGBW 162mm



description

On request Honey-comb

suitable for: Periskop

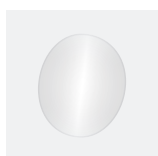

description

On request Filtre elliptique

suitable for: Periskop

shaker

Matériaux

Corps en aluminium

Diffuseur en verre trempé extra-clair



Shaker | Accent lighting | 198-264 V AC | arrayLED 6,5 W DC - 8,5 W AC

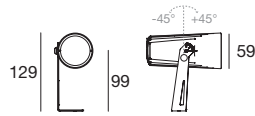
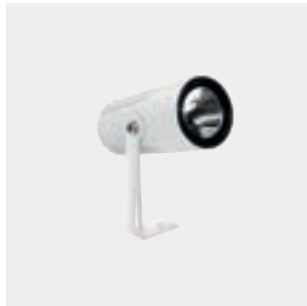

		Cct	lm S - D	Optic
White	96981	M 2700	770 - 582	15 Spot (14°)
Black	96982	W 3000	770 - 624	30 Flood (18°)
Grey	96983	N 4000	831 - 624	60 W.Flood (55°)
DarkBrown	96989			
Sand	82509			

Accessoires Pag. 801

RTG 96981W30 / 96981W60 / 96982W30 / 96982W60
96983W30 / 96983W60 / 96989W30 / 96989W60

Shaker | Accent lighting | 198-264 V AC | arrayLED 23 W DC - 26 W AC

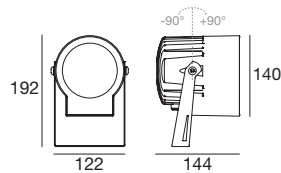

		Cct	lm S - D	Optic
White	91331	M 2700	3101 - 2847	15 Spot (19°)
Black	91338	W 3000	3321 - 3049	30 Flood (29°)
Grey	91342	N 4000	3568 - 3276	60 W.Flood (51°)
DarkBrown	83711			
Sand	82511			

Accessoires Pag. 801

Accessoires



description	
98514	Anti-éblouissement
suitable for: Shaker 6,5W	



description	
99819	Anti-éblouissement
suitable for: Shaker 15W	

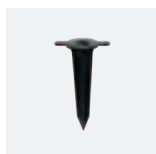

description	
89371	Piquet
suitable for: Shaker 6,5W / Shaker 15W	



description	
98549	Piquet
suitable for: Shaker 23W	

gardener

Matériaux

Corps en aluminium

Réflecteur en polycarbonate métallisé





Gardener | Accent lighting | 198-264 V AC | arrayLED 8 W DC - 9 W AC

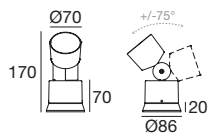
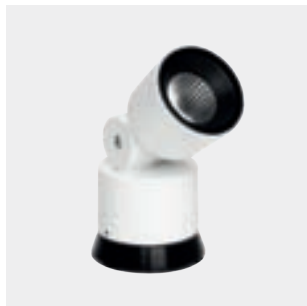

		Cct	lm S - D	Optic
White	97270	M 2700	1088 - 0n req	15 Spot (19°)
Black	97271	W 3000	1088 - 867	30 Flood (27°)
Grey	97272	N 4000	1173 - 933	60 E.W.Flood(71°)
DarkBrown	97387			

Accessoires Pag. 805

Gardener | Accent lighting | 198-264 V AC | arrayLED 18 W DC - 20 W AC

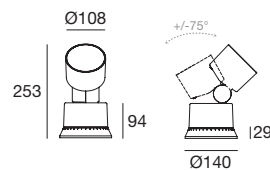

		Cct	lm S - D	Optic
White	81308	M 2700	2714 - 1832	15 Spot (18°)
Black	81309	W 3000	2900 - 1958	30 Flood (37°)
Grey	81310	N 4000	2900 - 1958	60 W.Flood (65°)
DarkBrown	81311			

Accessoires Pag. 805

Gardener | Accent lighting | 198-264 V AC | arrayLED 26 W DC - 29 W AC

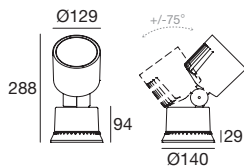

		Cct	lm S - D	Optic
White	81312	M 2700	3400 - 2829	15 Spot (20°)
Black	81313	W 3000	3637 - 3023	30 Flood (28°)
Grey	81314	N 4000	3909 - 3252	60 W.Flood (52°)
DarkBrown	81315			

Accessoires Pag. 805

Gardener RGBW | Accent lighting | powerLED 8 W DC 630 mA

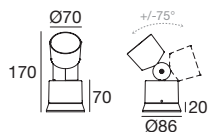
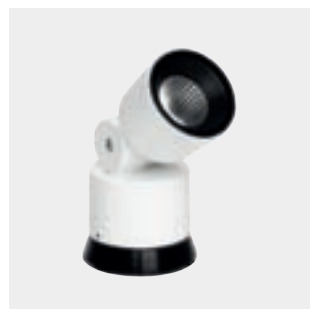

		V	RGBW warm white	Optic	
White	81505			05	Spot -
Black	81506			15	Flood -
Grey	81507			45	W.Flood -
DarkBrown	81508				

Électronique

99743 + 99702	99333	DMX	Driver	Switching
Dimmer RF 1 - 12 art.	Dimmer DMX 2 - 12 art.	DMX Controllers CV 24V/48V Pag. 952 - 953	Driver CV 48V Pag. 941	Switching CV 48V Pag. 932

Accessoires Pag. 805

Gardener RGBW | Accent lighting | arrayLED 18 W DC 500 mA

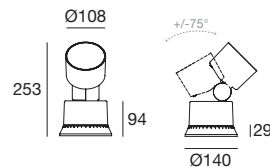
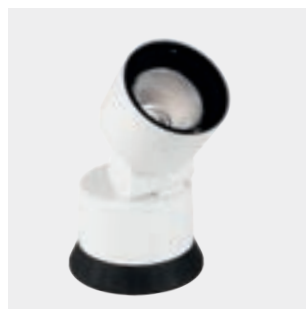

		V	RGBW warm white	Optic	
White	81501			15	Spot -
Black	81502			30	Flood -
Grey	81503			60	W.Flood -
DarkBrown	81504				

Électronique

99742 + 99702	99333	DMX	Driver	Switching
Dimmer RF 1 - 4 art.	Dimmer DMX 1 - 4 art.	Controllers Pag. 952 - 953	CV 48V Pag. 941	CV 48V Pag. 932

Accessoires Pag. 805

Accessoires



description	
89371	Piquet
suitable for: Gardener / Gardener RGBW	

narcissus

Matériaux

Corps en inox AISI 316L

Diffuseur en verre trempé extra-clair



Narcissus | Accent lighting | 198-264 V AC | powerLED 2 W DC - 2,2 W AC

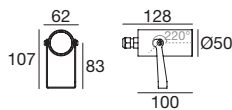

	Cct	lm S - D	Optic
Steel 95151	M 2700	219 - 0n req	08 N.Spot (10°)
	W 3000	233 - 178	15 Spot (18°)
	N 4000	249 - 189	30 Flood (27°)
			60 W.Flood (45°)

Accessoires Pag. 807

Narcissus | Accent lighting | 198-264 V AC | powerLED 6 W DC - 8 W AC

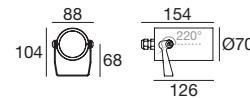

	Cct	lm S - D	Optic
Steel 95152	M 2700	536 - 476	15 Spot (18°)
	W 3000	566 - 503	30 Flood (27°)
	N 4000	626 - 556	60 W.Flood (45°)

Accessoires Pag. 807

Narcissus | Accent lighting | 198-264 V AC | arrayLED 13 W DC - 13,5 W AC

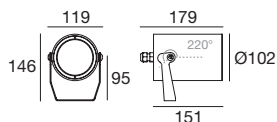

	Cct	lm S - D	Optic
Steel 81945	M 2700	1724 - 0n req	15 Spot -
	W 3000	1724 - 0n req	30 Flood -
	N 4000	1854 - 0n req	60 W.Flood -

Accessoires Pag. 807

Accessoires



	description
84890	Piquet en acier 250 mm
suitable for: Narcissus	



	description
98112	Piquet en acier 700 mm
suitable for: Narcissus	





HOTEL
EZZO

clivo

Matériaux

Corps en laiton ou en inox AISI316L
Diffuseur en verre trempé extra-clair



Clivo | Accent lighting | 190-250 V AC | powerLED 2 W DC - 2,2 W AC

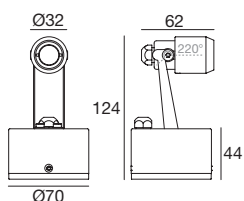
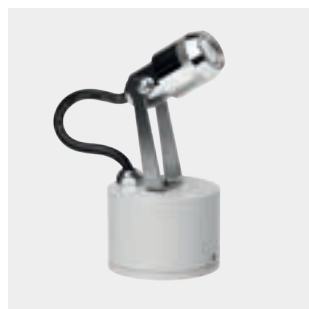

		Cct	lm S - D	Optic
Chrome	92203	M 2700	219 - On req	85 10°-60°
Nickel	92204	W 3000	233 - On req	
		N 4000	249 - On req	

Accessoires Pag. 811

Clivo_SL | Accent lighting | powerLED 4 W DC 350 mA

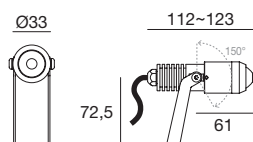

		Cct	lm S - D	Optic
White	90400	M 2700	490 - On req	85 10°-60°
Black	90401	W 3000	490 - On req	
Chrome	90402	N 4000	529 - On req	
Nickel	90403			
DarkBrown	90404			
Brass	81474			

Électronique

89421	99183	83100
ON/OFF 1 art. p 65 x l 74 x h 27	ON/OFF 1 - 2 art. p 80 x l 100 x h 31	DALI 1 - 4 art. p 54 x l 121 x h 26

Accessoires Pag. 811

Clivo_2 | Accent lighting | powerLED 2 W DC 630 mA

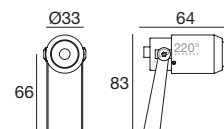

		Cct	lm S - D	Optic
White	97068	M 2700	219 - On req	85 10°-60°
Black	97069	W 3000	233 - 168	
Chrome	97072	N 4000	249 - 180	
Nickel	97071			
DarkBrown	97070			
Brass	81473			
Steel	97073			

Électronique

89420	99179	99186	83102
ON/OFF 1 - 2 art. p 65 x l 74 x h 27	ON/OFF 3 - 6 art. p 80 x l 100 x h 31	ON/OFF 6 - 12 art. p 92 x l 117 x h 38	DALI 1 - 14 art. p 54 x l 121 x h 26

Accessoires Pag. 811

Accessoires



description

84890 Piquet en acier 250 mm
suitable for: Clivo_2 2W / Clivo_SL 4W



description

98112 Piquet en acier 700 mm
suitable for: Clivo_2 2W / Clivo_SL 4W



description

98513 Anti-éblouissement
suitable for: Clivo 2W / Clivo_2 2W / Clivo_SL 4W



description

89371 Piquet
suitable for: Clivo 2W

iris67

Matériaux

Corps en aluminium



Projecteur polyvalent en IP67

Avec son esthétique soignée et ses formes minimalistes, Iris67 offre la possibilité de contrôler de manière professionnelle le faisceau lumineux dans un environnement extérieur, permettant ainsi un large éventail d'applications d'éclairage pour les éléments décoratifs (statues, installations) et les grands arbres. Un luminaire perfectionné, IP67 et entièrement en aluminium : le design concret et fiable d'Iris67 garantit une protection maximale contre les agents atmosphériques, l'eau (à l'exception de l'immersion) et les particules microscopiques.



Optique ajustable

Iris67 permet d'ajuster le faisceau lumineux en fonction des besoins d'orientation liés aux environnements extérieurs, et peut ainsi s'adapter à la croissance de grands arbres et/ou mettre en valeur des éléments de mobilier urbain de tailles différentes. La bague graduée de focalisation intégrée permet de calibrer l'ouverture du faisceau, variable en fonction du modèle choisi, et rend ainsi l'opération d'orientation simple et précise. Le système de verrouillage de l'angle d'ouverture, facile à utiliser, permet d'obtenir une ouverture correspondant à l'angle sélectionné sur la bague.



Gamme optique dynamique

La version Elliptic représente le produit phare de la famille Iris67, une nouveauté de qui augmente le potentiel d'un projecteur d'extérieur hautement professionnel. Outre le réglage de l'ouverture du faisceau, Iris67 Elliptic intègre une deuxième bague permettant de contrôler le mouvement d'un filtre spécifique placé à l'extrémité de l'appareil. En augmentant ou en diminuant la distance du filtre par rapport à l'objectif principal, il est possible de modifier la forme du faisceau lumineux, obtenant ainsi un éclairage elliptique idéal pour les grands arbres ou les éléments urbains verticaux (ex. les enseignes).



Iris67 | Accent lighting | arrayLED 6 W DC 630 mA

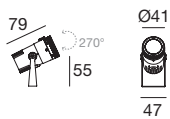
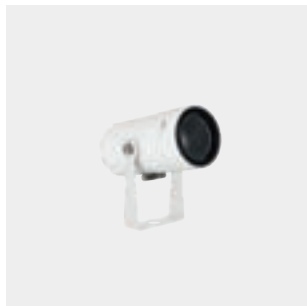

		Cct	lm S - D	Optic
White	92230	M 2700	685 - On req	85 15°-45°
Black	92231	W 3000	685 - 620	
Grey	92232	N 4000	739 - 620	

Électronique

99179	99186	83102
ON/OFF 1 - 2 art.	ON/OFF 2 - 4 art.	DALI 1 - 4 art.
p 80 x l 100 x h 31	p 92 x l 117 x h 38	p 54 x l 121 x h 26

Accessoires Pag. 815

RTG 92230W85 / 92231W85 / 92232W85

Iris67 | Accent lighting | arrayLED 12 W DC 350 mA

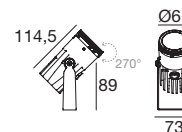

		Cct	lm S - D	Optic
White	97318	M 2700	1724 - On req	85 15°-62°
Black	97319	W 3000	1724 - 1487	
Grey	97320	N 4000	1854 - 1487	

Électronique

99183	83100
ON/OFF 1 art.	DALI 1 art.
p 80 x l 100 x h 31	p 54 x l 121 x h 26

Accessoires Pag. 815

RTG 97318W85 / 97319W85 / 97320W85

Iris67 | Accent lighting | arrayLED 23 W DC 630 mA

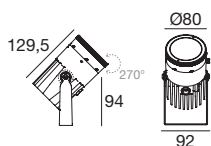

		Cct	lm S - D	Optic
White	97321	M 2700	2714 - On req	85 16°-52°
Black	97322	W 3000	2900 - 2343	
Grey	97323	N 4000	2900 - 2516	

Électronique

99186	83102
ON/OFF 1 art.	DALI x art.
p 92 x l 117 x h 38	p 54 x l 121 x h 26

Accessoires Pag. 815

Iris67 | Accent lighting | arrayLED 30 W DC 840 mA

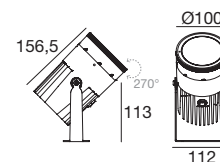

		Cct	lm S - D	Optic
White	97324	M 2700	4220 - 1388	85 15°-56°
Black	97325	W 3000	4535 - 3859	
Grey	97326	N 4000	4535 - 3859	

Électronique

99269
ON/OFF 1 art.
p 92 x l 117 x h 38

Accessoires Pag. 815

Iris67 Elliptic | Accent lighting | arrayLED 6 W DC 630 mA

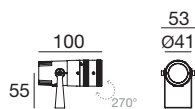
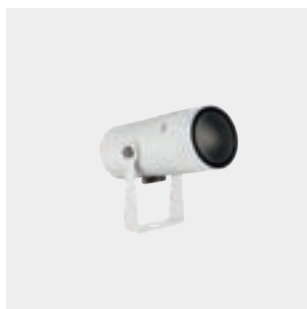

		Cct	lm S - D	Optic
White	81720	M 2700	685 - On req	88 15°- 45°
Black	81721	W 3000	685 - On req	
Grey	81722	N 4000	739 - On req	

Électronique

99179	99186	83102
ON/OFF 1- 2 art. p 80 x l 100 x h 31	ON/OFF 2- 4 art. p 92 x l 117 x h 38	DALI 1- 4 art. p 54 x l 121 x h 26

Accessoires Pag. 815

Iris67 Elliptic | Accent lighting | arrayLED 13 W DC 350 mA

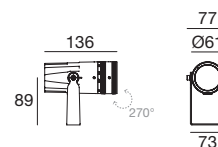

		Cct	lm S - D	Optic
White	81723	M 2700	1724 - On req	88 15°- 62°
Black	81724	W 3000	1724 - On req	
Grey	81725	N 4000	1854 - On req	

Électronique

99183	83100
ON/OFF 1 art. p 80 x l 100 x h 31	DALI 1 art. p 54 x l 121 x h 26

Accessoires Pag. 815

Iris67 Elliptic | Accent lighting | arrayLED 23 W DC 630 mA

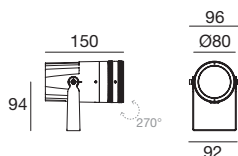

		Cct	lm S - D	Optic
White	81726	M 2700	2714 - On req	88 16°- 52°
Black	81727	W 3000	2900 - On req	
Grey	81728	N 4000	2900 - On req	

Électronique

99186	83102
ON/OFF 1 art. p 92 x l 117 x h 38	DALI x art. p 54 x l 121 x h 26

Accessoires Pag. 815

Iris67 Elliptic | Accent lighting | arrayLED 30 W DC 840 mA

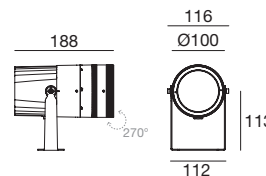

		Cct	lm S - D	Optic
White	81729	M 2700	4220 - On req	88 15°- 56°
Black	81730	W 3000	4535 - On req	
Grey	81731	N 4000	4535 - On req	

Électronique

99269
ON/OFF 1 art. p 92 x l 117 x h 38

Accessoires Pag. 815

Accessoires



description
84890 Piquet en acier 250 mm
suitable for: Iris67 - Iris67 Elliptic



description
98112 Piquet en acier 700 mm
suitable for: Iris67 - Iris67 Elliptic

vuelta

Matériaux

Corps en aluminium

Diffuseur en verre transparent



Vuelta_Y | Outdoor spotlights | 100-264 V AC | arrayLED 13,5 W DC - 16 W AC

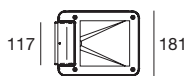
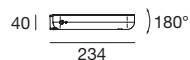

		Cct	lm S - D	Optic
Grey	64522	W 3000	1627 - On req	07 Asymm. -
BK Grey	64523	N 4000	1718 - On req	

Accessoires Pag. 817

Vuelta | Outdoor spotlights | 100-264 V AC | arrayLED 13,5 W DC - 16 W AC

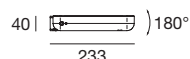

		Cct	lm S - D	Optic
Grey	64520	W 3000	1627 - On req	12 E.W.Flood(97°)
BK Grey	64521	N 4000	1718 - On req	

Accessoires Pag. 817

Vuelta_Y | Outdoor spotlights | Pole-top | 176-264 V AC | arrayLED 30 W DC - 32 W AC

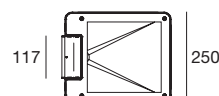
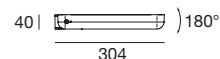

		Cct	lm S - D	Optic
Grey	64530	W 3000	3565 - On req	07 Asymm. -
BK Grey	64531	N 4000	3832 - On req	

Accessoires Pag. 817

Vuelta | Outdoor spotlights | Pole-top | 176-264 V AC | arrayLED 30 W DC - 32 W AC

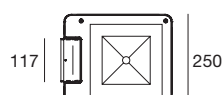
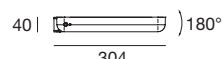

		Cct	lm S - D	Optic
Grey	64528	W 3000	4171 - On req	12 E.W.Flood(97°)
BK Grey	64529	N 4000	4486 - On req	

Accessoires Pag. 817

Piquet



Support angulaire



Grille



Pôle



Kit pour le pôle



Accessoires

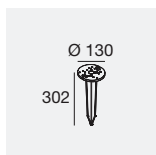

	description	type
14931	Piquet	Black

suitable for: Vuelta_Y / Vuelta

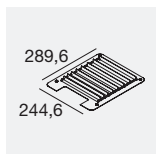

	description	type
64534	Grille	Black

suitable for: Vuelta_Y 30W / Vuelta 30W

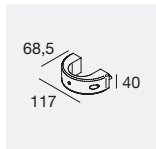

	description	type
64532	Kit pour le pôle	Grey
64533	Kit pour le pôle	BK Grey

suitable for: Vuelta_Y / Vuelta

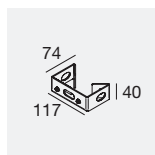

	description	type
64538	Support angulaire	Grey
64539	Support angulaire	BK Grey

suitable for: Vuelta_Y / Vuelta

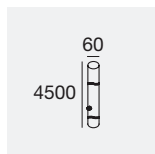

	description	type
64536	Pôle	Grey
64537	Pôle	BK Grey

suitable for: Vuelta_Y / Vuelta

prolamp

Matériaux

Corps en aluminium anodisé à pores
ouverts avec revêtement par poudre
Diffuseur en verre transparent





Prolamp | Accent lighting | 198-264 V AC | 2 x arrayLED 65 W DC - 72 W AC

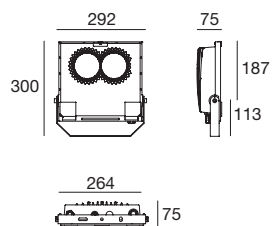
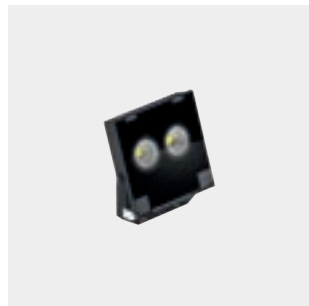

		Cct	lm S - D	Optic
Black	83851	M 2700	7517 - On req	15 Spot -
DALI		W 3000	7873 - On req	30 Flood -
Black	83852	N 4000	8464 - On req	60 W.Flood -

Câble d'entrée-sortie inclus

Câbles Pag. 820

Prolamp | Accent lighting | 198-264 V AC | 3 x arrayLED 101 W DC - 111 W AC

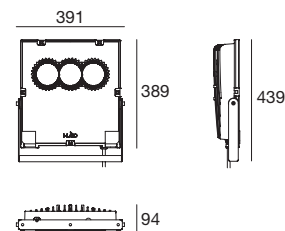

		Cct	lm S - D	Optic
Black	83853	M 2700	11533 - On req	15 Spot -
DALI		W 3000	12350 - On req	30 Flood -
Black	83854	N 4000	12988 - On req	60 W.Flood -

Câble d'entrée-sortie inclus

Câbles Pag. 820

Prolamp | Accent lighting | 198-264 V AC | 4 x arrayLED 171 W DC - 180 W AC

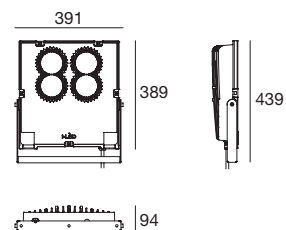
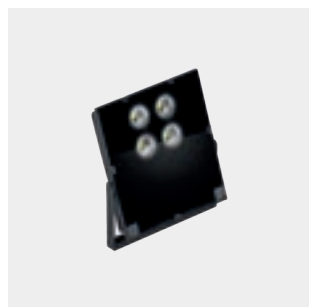

		Cct	lm S - D	Optic
Black	83855	M 2700	20124 - On req	15 Spot -
DALI		W 3000	21079 - On req	30 Flood -
Black	83856	N 4000	22660 - On req	60 W.Flood -

Câble d'entrée-sortie inclus

Câbles Pag. 820

Prolamp | Accent lighting | 198-264 V AC | 6 x arrayLED 270 W DC - 280 W AC

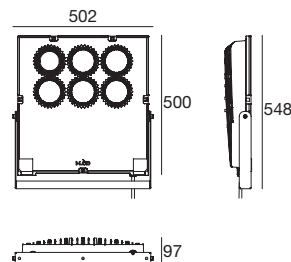

		Cct	lm S - D	Optic
Black	83857	M 2700	31739 - On req	15 Spot -
DALI		W 3000	33245 - On req	30 Flood -
Black	83858	N 4000	35738 - On req	60 W.Flood -

Câble d'entrée-sortie inclus

Câbles Pag. 820

Câbles



On/Off 190-250V AC	
99057	Conn. F.3 pin (L 2m)

suitable for: Prolamp



DALI 190-250V AC	
99826	Conn. F. 5 pin (L 1m)
99822	Conn. F. 5 pin (L 5m)

suitable for: Prolamp (DALI)



On/Off 190-250V AC	
98147	Conn. M. / F. 3 pin (L 5m)
98146	Conn. M. / F. 3 pin (L 10m)

suitable for: Prolamp



DALI 190-250V AC	
99823	Conn. M. / F. 5 pin (L 1m)
99824	Conn. M. / F. 5 pin (L 5m)
99825	Conn. M. / F. 5 pin (L 10m)

suitable for: Prolamp (DALI)

Prolamp | Accent lighting | 48 V | 8 x powerLEDs 59 W DC - 64 W AC

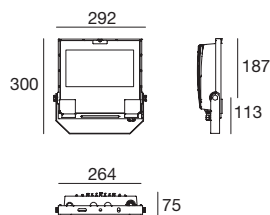
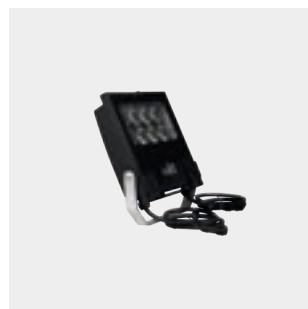

	Cct	lm S - D	Optic
Black 81946	W 3000	6473 - On req	15 Spot -
	N 4000	6988 - On req	30 Flood -



	RGBW	Optic
Black 81949	Q RGBW natural white	06 N.Spot -
	V RGBW warm white	15 Spot -
		30 Flood -
		25 Elliptic -

Électronique

99785	DMX	99385	98986	98985/99390
ON/OFF 240W	DMX controllers Pag. 952 - 953	DMX/RDM addresser	120 Ohm DMX line closure	Connector splitter ALLinONE Start & Continuity Pag. 956

Câble d'entrée-sortie inclus

Accessoires et câbles Pag. 821

Prolamp | Accent lighting | 220-240 V AC | 24 x powerLEDs 174 W DC - 190 W AC

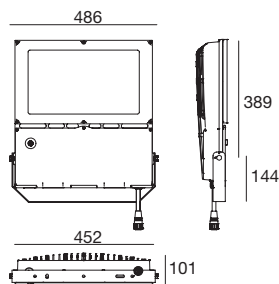

	Cct	lm S - D	Optic
Black 81948	W 3000	19419 - On req	15 Spot -
	N 4000	20964 - On req	30 Flood -



	RGBW	Optic
Black 81951	Q RGBW natural white	06 N.Spot -
	V RGBW warm white	15 Spot -
		30 Flood -
		25 Elliptic -

Électronique

DMX	99385	98986	98985/99390
DMX controllers Pag. 952 - 953	DMX/RDM addresser	DMX LINE Clouser 120 Ohm	Splitter ALLinONE Start & Continuity Pag. 956

Câble d'entrée-sortie inclus

Accessoires et câbles Pag. 821

Accent lighting

Prolamp | Accent lighting | 220-240 V AC | 18 x powerLEDs 133 W DC - 150 W AC

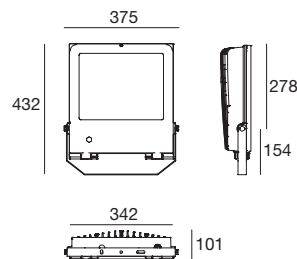
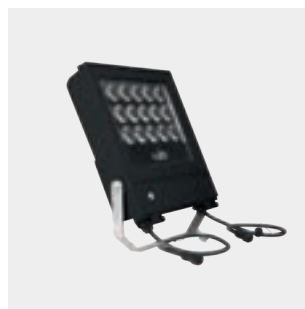

	Cct	lm S - D	Optic
Black 81947	W 3000	14564 - On req	15 Spot -
	N 4000	15723 - On req	30 Flood -



	RGBW	Optic
Black 81950	Q RGBW natural white	06 N.Spot -
	V RGBW warm white	15 Spot -
		30 Flood -
		25 Elliptic -

Électronique

DMX	99385	98986	98985/99390
DMX controllers Pag. 952 - 953	DMX/RDM addresser	DMX LINE Clouser 120 Ohm	Splitter ALLinONE Start & Continuity Pag. 956

Câble d'entrée-sortie inclus

Accessoires et câbles Pag. 821

Accessoires

	description
	On request Volets directionnels - shaper
	suitable for: Prolamp 59W - 133W - 174W / Prolamp RGBW

Câbles

	On/Off 190-250V AC
	99057 Conn. F.3 pin (L 2m)
	suitable for: Prolamp 59W - 133W - 174W

	AllinOne DMX cable 190-250V AC
	98660 F. 6 pin (L 1m)
	98661 F. 6 pin (L 5m)
	suitable for: Prolamp RGBW

Câbles d'extension

	On/Off 190-250V AC
	98147 Conn. M. / F. 3 pin (L 5m)
	98146 Conn. M. / F. 3 pin (L 10m)
	suitable for: Prolamp 59W - 133W - 174W

	AllinOne DMX cable 190-250V AC
	98662 M. / F. 6 pin (L 1m)
	98663 M. / F. 6 pin (L 5m)
	suitable for: Prolamp RGBW

archiline

Matériaux

Corps en aluminium

Diffuseur en verre trempé extra-clair



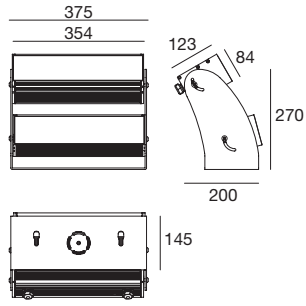

		Cct	lm S - D	Optic
Black	81483	M 2700	5061 - 0n req	15 Spot -
		W 3000	5442 - 0n req	30 Flood -
		N 4000	5874 - 0n req	25 Elliptic -

		Cct	lm S - D	Optic
Black	81484	M 2700	5061 - 0n req	06 N.Spot -
		W 3000	5442 - 0n req	
		N 4000	5874 - 0n req	

The image on page 822 is a custom solution.





Light effects

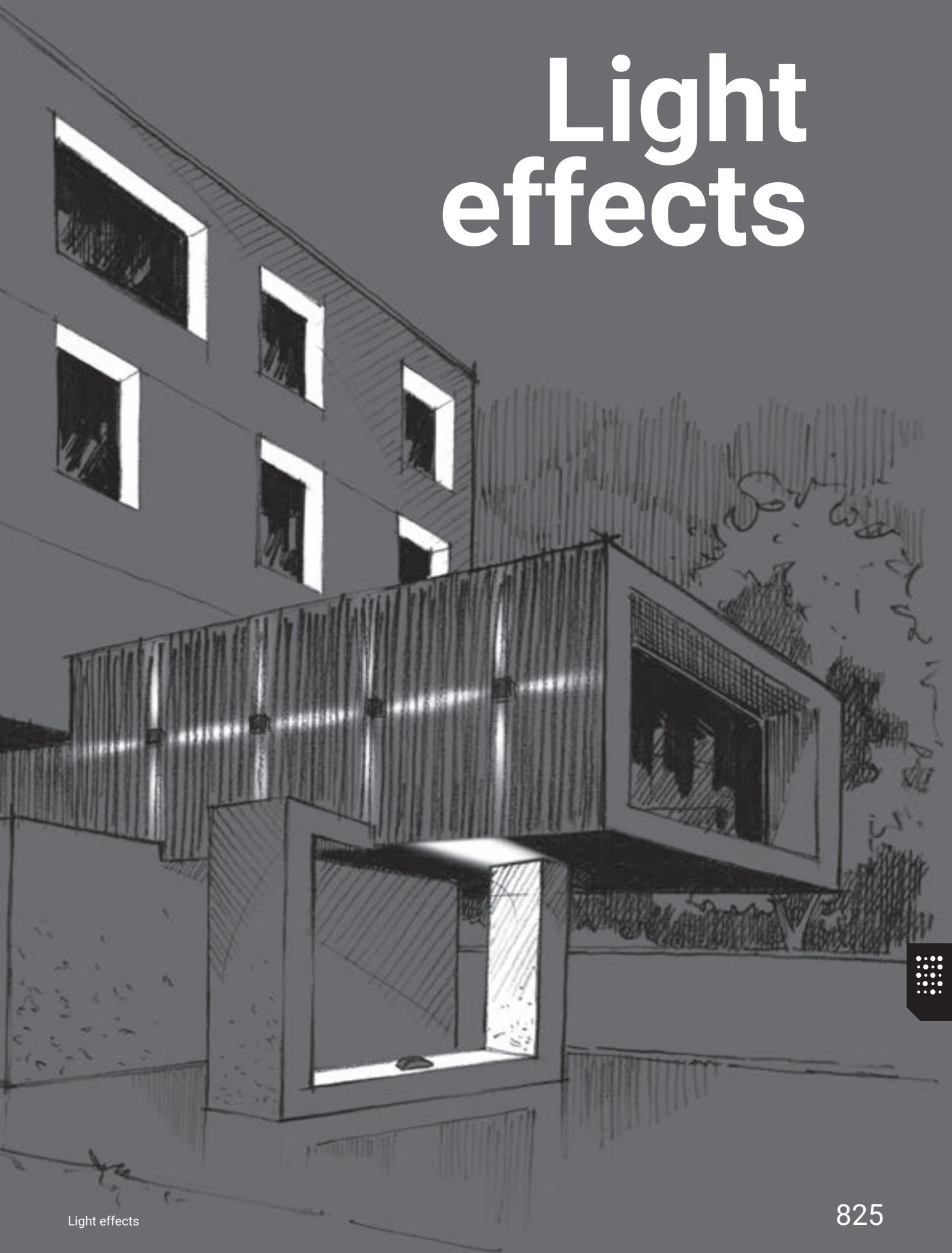

light effects range index

Arcada



Xenia



Orma

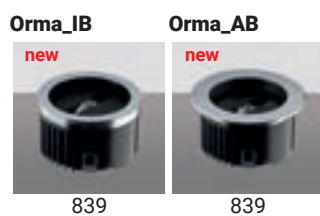

Myia



Lopp66



Xenia



Pixie



Paseo

Paseo_PIXEL

Paseo_PIXEL
Dark



851



851

Arcada

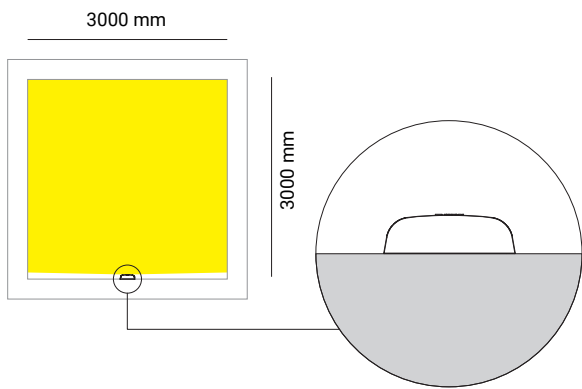

Arcada_Pro

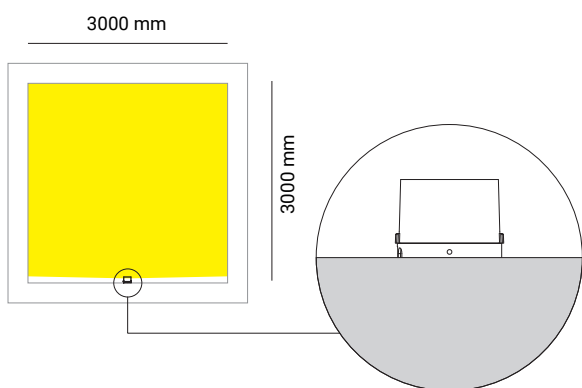

Xenia Blade



3000 mm

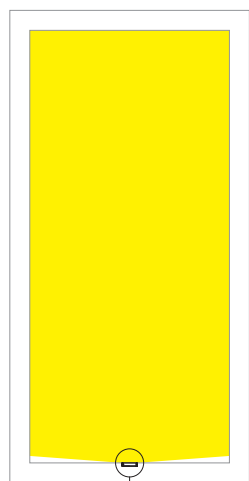

6500 mm

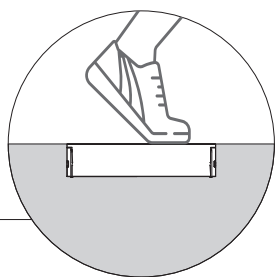

Orma



3000 mm

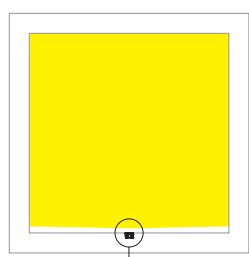

3000 mm

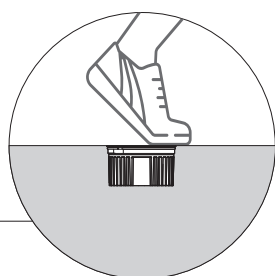

arcada

Matériaux

Corps en aluminium/polycarbonate





Arcada | Arc light | 198-264V AC | powerLED 4 W DC - 6 W AC

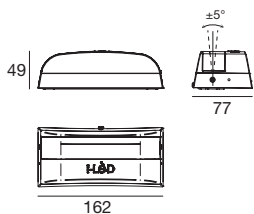

		Cct	lm S - D	Optic
White	95454	M 2700	544 - 394	18 E.W.Flood(140°)
Black	95612	W 3000	580 - 424	
Grey	95619	N 4000	620 - 450	

Arcada | Arc light | powerLED 8W DC 630 mA

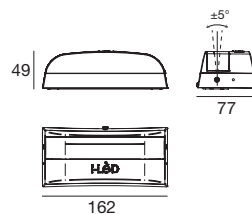

		Cct	lm S - D	Optic
White	95458	M 2700	876 - 636	18 E.W.Flood(140°)
Black	95616	W 3000	932 - 678	
Grey	95623	N 4000	996 - 724	

Électronique

99179	99186	83102
ON/OFF 1 art.	ON/OFF 2 - 3 art.	DALI 1 - 3 art.
p 80 x l 100 x h 31	p 92 x l 117 x h 38	p 53 x l 121 x h 26

Arcada | Arc light | powerLED 8 W DC 220 mA x Ch

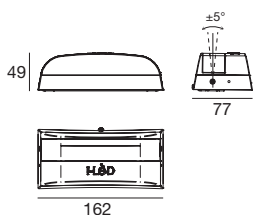

			Optic
White	95749	Z RGB	18 E.W.Flood -
Black	95750		
Grey	95751		

Électronique

99703 + 99702	99333	DMX	Driver	Switching
Dimmer RF 1 - 3 art.	Dimmer DMX 1 - 3 art.	DMX Controllers Pag. 952 - 953	Driver CV 48V Pag. 941	Switching CV 48V Pag. 932

95458N18

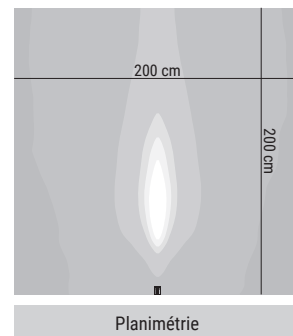
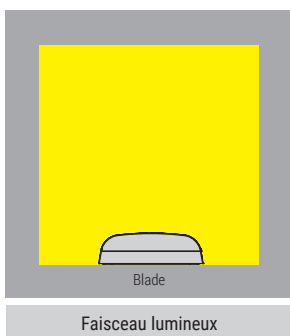
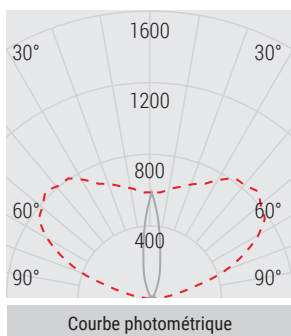

Arcada Pro | Arc light | 198-264V AC | powerLED 4 W DC - 6 W AC

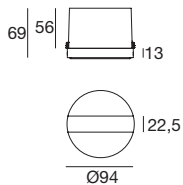

		Cct	lm S - D	Optic
White	84283	M 2700	440 - On req	18 E.W.Flood(128°)
Black	84284	W 3000	500 - On req	
Grey	84285	N 4000	536 - On req	

Arcada Pro | Arc light | 198-264V AC | powerLED 4 W DC 350 mA x Ch

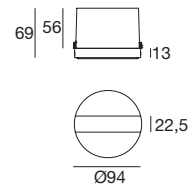

			Optic
White	84286	Q RGBW natural white	18 E.W.Flood -
Black	84287	V RGBW warm white	
Grey	84288		

Électronique

99741 + 99702	99333	DMX	Driver	Switching
Dimmer RF 1 - 12 art.	Dimmer DMX 2 - 12 art.	DMX Controllers Pag. 952 - 953	Driver CV 48V Pag. 941	Switching CV 48V Pag. 932

84283N18

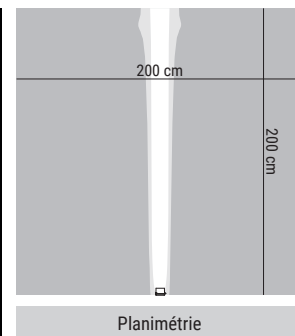
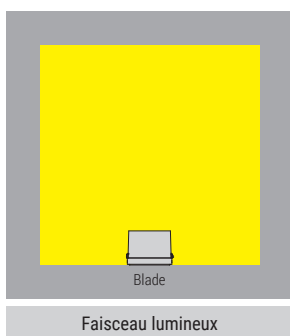
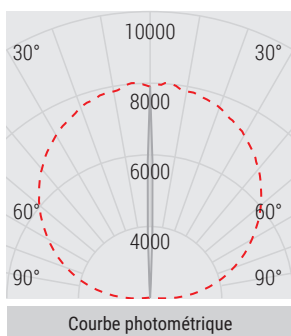





NYX HOTEL



xenia

Matériaux

Corps en aluminium



Xenia_A_Blade | Arc light | powerLED 6 W DC 500mA

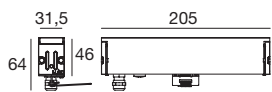

Anod. AL.	82761	Cct	Im S - D	Optic
		M 2700	453 - On req	18 E.W.Flood -
		W 3000	516 - On req	
		N 4000	552 - On req	

Électronique

99181	99185	83101
ON/OFF 1 art. p 80 x l 100 x h 31	ON/OFF 2 - 3 art. p 92 x l 117 x h 38	DALI 1 - 4 art. p 54 x l 121 x h 26



Boîtier d'encastrement et accessoires Pag. 837

Xenia_AL_Blade | Arc light | powerLED 6 W DC 500mA

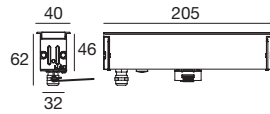

Anod. AL.	82762	Cct	Im S - D	Optic
		M 2700	453 - On req	18 E.W.Flood -
		W 3000	516 - On req	
		N 4000	552 - On req	

Électronique

99181	99185	83101
ON/OFF 1 art. p 80 x l 100 x h 31	ON/OFF 2 - 3 art. p 92 x l 117 x h 38	DALI 1 - 4 art. p 54 x l 121 x h 26



Boîtier d'encastrement et accessoires Pag. 837

Boîtier d'encastrement

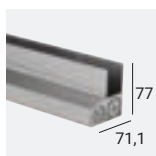

description	
99933	205 mm
suitable for: Xenia_A_blade	



description	
99932	205 mm
suitable for: Xenia_AL_blade	

Accessoires



description	
99917	Bouchons de fermeture
suitable for: Xenia_A_blade	



description	
83188	Bouchons de fermeture
suitable for: Xenia_AL_blade	

Light effects



orma

Matériaux

Corps en aluminium

Bride en inox AISI 316L



Orma_IB | Up-Light | powerLED

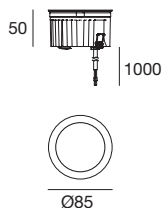

C.C. - 8W DC 630 mA	Cct	lm S - D	Optic
Steel/Alu 83642	M 2700	854 - On req	18 E.W.Flood -
	W 3000	854 - On req	
	N 4000	922 - On req	

Électronique

99179	99186	83102
ON/OFF 1 art. p 80 x l 100 x h 31	ON/OFF 2 - 3 art. p 92 x l 117 x h 38	DALI 1 - 3 art. p 53 x l 121 x h 26

C.V. 9W DC 24V DC	Cct	lm S - D	Optic
Steel/Alu 83643	M 2700	854 - On req	18 E.W.Flood -
	W 3000	854 - On req	
	N 4000	922 - On req	

Électronique

89179	89359	99331	99332	99722
ON/OFF 1 - 2 art. p 92 x l 117 x h 38	ON/OFF 1 - 5 art. p 115 x l 140 x h 50	ON/OFF 1 - 15 art. p 150 x l 160 x h 35	0/1-10V 1 - 15 art. p 150 x l 160 x h 35	DALI 1 - 12 art. p 191 x l 163 x h 38

Boîtier d'encastrement Pag. 839

Orma_AB | Up-Light | powerLED

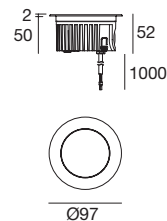

C.C. - 8W DC 630 mA	Cct	lm S - D	Optic
Steel/Alu 83644	M 2700	854 - On req	18 E.W.Flood -
	W 3000	854 - On req	
	N 4000	922 - On req	

Électronique

99179	99186	83102
ON/OFF 1 art. p 80 x l 100 x h 31	ON/OFF 2 - 3 art. p 92 x l 117 x h 38	DALI 1 - 3 art. p 53 x l 121 x h 26

C.V. 9W DC 24V DC	Cct	lm S - D	Optic
Steel/Alu 83645	M 2700	854 - On req	18 E.W.Flood -
	W 3000	854 - On req	
	N 4000	922 - On req	

Électronique

89179	89359	99331	99332	99722
ON/OFF 1 - 2 art. p 92 x l 117 x h 38	ON/OFF 1 - 5 art. p 115 x l 140 x h 50	ON/OFF 1 - 15 art. p 150 x l 160 x h 35	0/1-10V 1 - 15 art. p 150 x l 160 x h 35	DALI 1 - 12 art. p 191 x l 163 x h 38

Boîtier d'encastrement Pag. 839

Boîtier d'encastrement



description	type
99651 Boîtiers d'encastrement	PVC
suitable for: Orma_AB / Orma_IB	



description	type
99563 Boîtiers d'encastrement	PVC
suitable for: Orma_IB	



description	type
99856 Boîtiers d'encastrement	PVC
suitable for: Orma_IB	

Light effects



myia

Matériaux
Corps en aluminium



Myia | Wall light | 198-264V AC | powerLED 8W DC - 9W AC

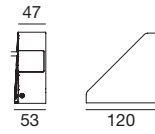
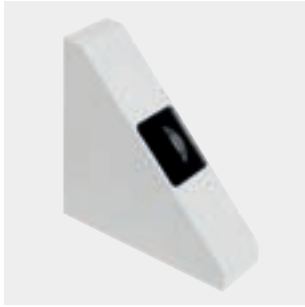
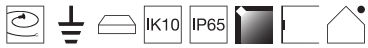

		Cct	lm S - D	Optic
White	91596	M 2700	877 - 311	90 E.W.Flood -
Black	91597	W 3000	945 - 311	
Grey	91598	N 4000	1013 - 335	

Private Villa | Athens, Greece



Light effects

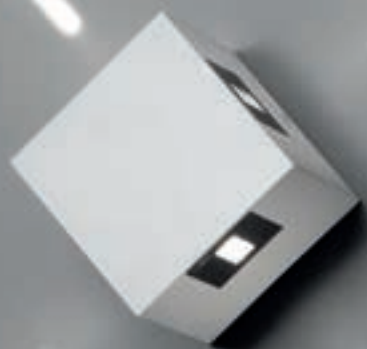

loop66

Matériaux
Corps en aluminium

Loop66 | Wall light | 198-264V AC | powerLEDs 23W DC - 25 W AC

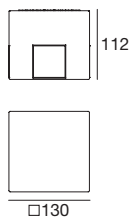
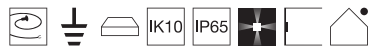

		Cct	lm S - D	Optic
White	97065	M 2700	2628 - 1170	05 N.Spot (5°)
Black	97066	W 3000	2796 - 1248	
Grey	97067	N 4000	2988 - 1332	
DarkBrown	97357			



Light effects





xenia

Matériaux

Corps en alliage d'aluminium 6060 anodisé



Xenia_PIXEL | Light effects | 48V DC | topLED 9,5 W DC

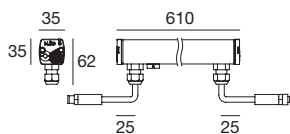

Optic

Anod. AL.	82596	Z RGB	00 General -
-----------	--------------	-------	---------------------

Accessoires Pag. 847

Pour les câbles et l'alimentation/l'unité de contrôle, contacter le service d'assistance Linea Light.

Xenia_PIXEL | Light effects | 48V DC | topLED 19 W DC

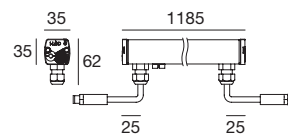

Optic

Anod. AL.	82597	Z RGB	00 General -
-----------	--------------	-------	---------------------

Accessoires Pag. 847

Pour les câbles et l'alimentation/l'unité de contrôle, contacter le service d'assistance Linea Light.

Accessoires



description

98949	Support de fixation 46-67 mm
suitable for: Xenia_PIXEL	



description

89045	Support de fixation 90 mm
suitable for: Xenia_PIXEL	



description

89046	Support de fixation 150 mm
suitable for: Xenia_PIXEL	



description

89047	Support de fixation 300 mm
suitable for: Xenia_PIXEL	



description

83190	Anti-éblouissement 595 mm
suitable for: Xenia_PIXEL	



description

83191	Anti-éblouissement 1170 mm
suitable for: Xenia_PIXEL	

pixie

Matériaux

Corps en aluminium anodisé à pores
ouverts avec revêtement par poudre
Diffuseur en PMMA opalin



Pixie_PIXEL | light effects | 48V DC | topLED 3,5 W DC

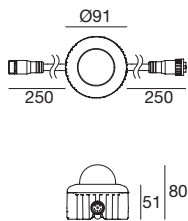

Optic

Grey **83841** Q RGBW natural white 00 General -

Accessoires et câbles Pag. 849

Pour l'alimentation/l'unité de contrôle, contacter le service d'assistance Linea Light.

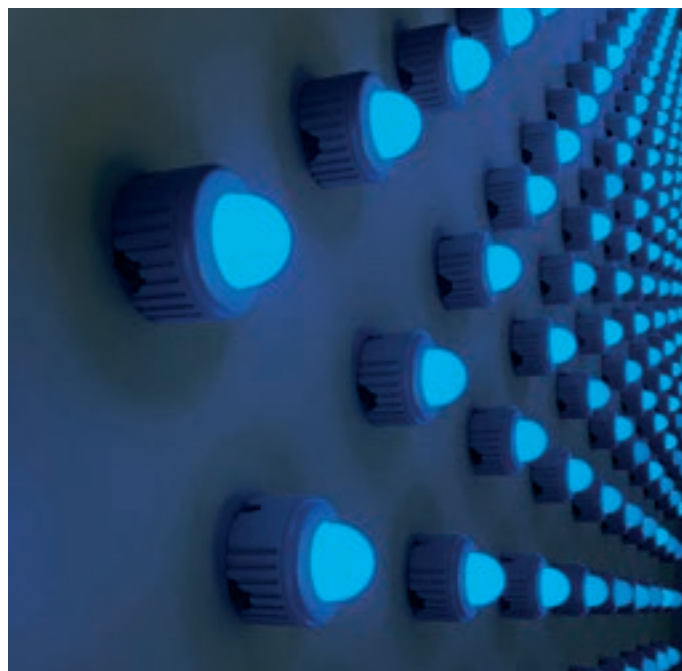

Accessoires

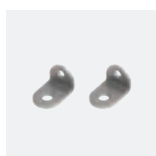

description

98659 Paire d'étriers de fixation latérale

suitable for: Pixie_PIXEL



description

98655 Support de fixation invisible

suitable for: Pixie_PIXEL



description

98654 Support de fixation invisible

suitable for: Pixie_PIXEL

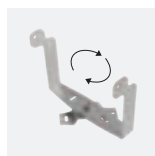

description

98653 Support de fixation basculant

suitable for: Pixie_PIXEL

Câbles



AllinOne SPI 48 V DC

83201 Conn. M. 4 pin M12 (L 2,5m)

suitable for: Pixie_PIXEL



AllinOne SPI 48 V DC

83202 Conn. F. 4 pin M12 (L 2,5m)

suitable for: Pixie_PIXEL

Câbles d'extension



AllinOne SPI 48 V DC

83199 Conn. M+F 4 pin M12 (L 1m)

83200 Conn. M+F 4 pin M12 (L 5m)

suitable for: Pixie_PIXEL

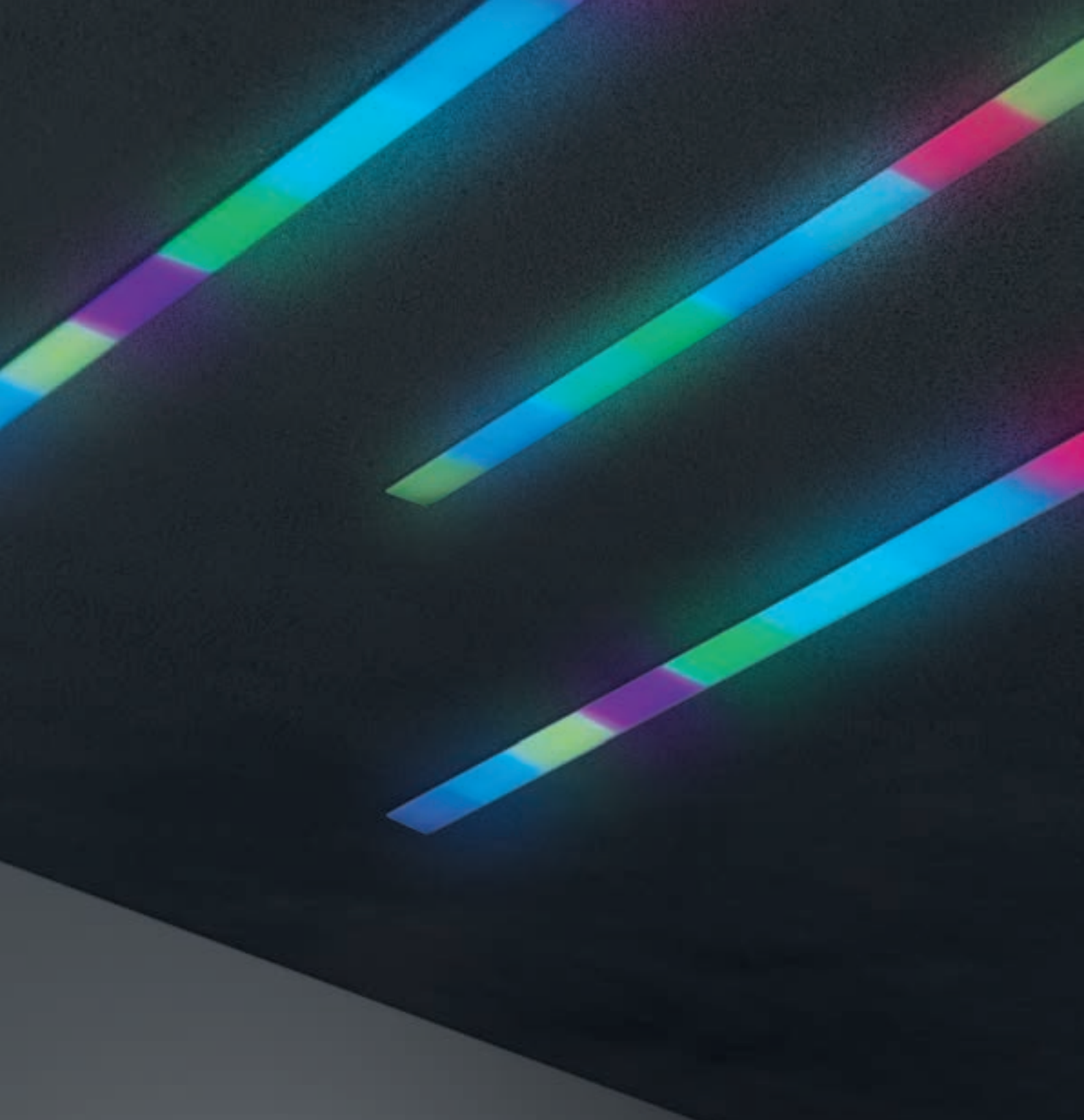

paseo

Matériaux
Corps en polycarbonate

Paseo_PIXEL | Light effects | 24V DC | topLED 9,5 W DC

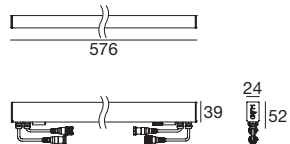

Optic

Opaline	81337	Z RGB	00 General -
---------	--------------	-------	---------------------

Boîtier d'encastrement Pag. 755/756/757

Pour les câbles et l'alimentation/l'unité de contrôle, contacter le service d'assistance Linea Light.

Paseo_PIXEL | Light effects | 24V DC | topLED 19,5W DC

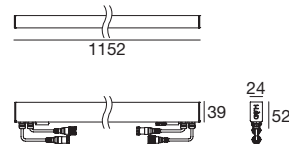

Optic

Opaline	81338	Z RGB	00 General -
---------	--------------	-------	---------------------

Boîtier d'encastrement Pag. 755/756/757

Pour les câbles et l'alimentation/l'unité de contrôle, contacter le service d'assistance Linea Light.

Paseo_PIXEL Dark | Light effects | 48V DC | topLED 9,5 W DC

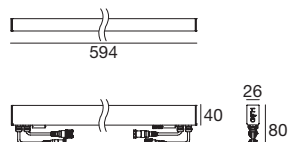

Optic

Black	84217	Z RGB	00 General -
-------	--------------	-------	---------------------

Accessoires Pag. 851

Pour les câbles et l'alimentation/l'unité de contrôle, contacter le service d'assistance Linea Light.



Paseo_PIXEL Dark | Light effects | 48V DC | topLED 19,5 W DC

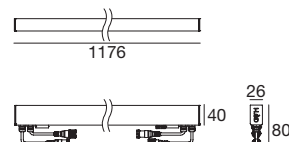

Optic

Black	84218	Z RGB	00 General -
-------	--------------	-------	---------------------

Accessoires Pag. 851

Pour les câbles et l'alimentation/l'unité de contrôle, contacter le service d'assistance Linea Light.



Accessoires



	description
83162	Étrier de support pour l'installation au mur
suitable for: Paseo_PIXEL Dark 9,5W / 19,5W	

Light effects

Paseo_PIXEL RGB

Performance d'éclairage et ingénierie

La barre i-LèD Paseo_PIXEL RGB redéfinit le paysage environnant à travers la création d'effets de lumière dynamiques. Chaque LED RGB peut être commandée individuellement. Les versions disponibles sont le Paseo_PIXEL RGB 576 mm avec 32 LED RGB full-color, ou le Paseo_PIXEL RGB 1152 mm avec 64 LED RGB full-color.



RGB
Pixel



Chaque LED est divisée en 3 canaux (Red, Green, Blue - Rouge, Vert, Bleu)

Power
24V

Signal
DMX / RDM

Les différentes résolutions disponibles permettent une flexibilité maximale et une excellente efficacité de contrôle avec le même produit ; il est possible de faire varier le rapport entre LED et pixel en fonction de la taille de l'installation. Le pixel est la diode RGB contrôlable individuellement. En résolution maximale, les modèles Paseo_PIXEL RGB de 1152 mm et 576 mm sont respectivement composés de 64 et 32 pixels indépendants. En résolution minimale, les modèles Paseo_PIXEL RGB de 1152 mm et 576 mm sont respectivement composés de 4 et 2 pixels indépendants. La programmation de la résolution est effectuée via RDM* (Remote Device Management ou gestion de dispositifs à distance), un système permettant une communication bidirectionnelle avec les luminaires. L'appareil recommandé pour effectuer cette opération est le Pro Mk2 d'Enttec.

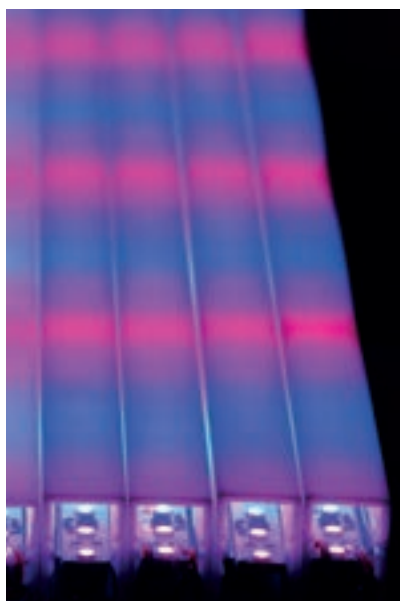

2 LEDs x Pixel

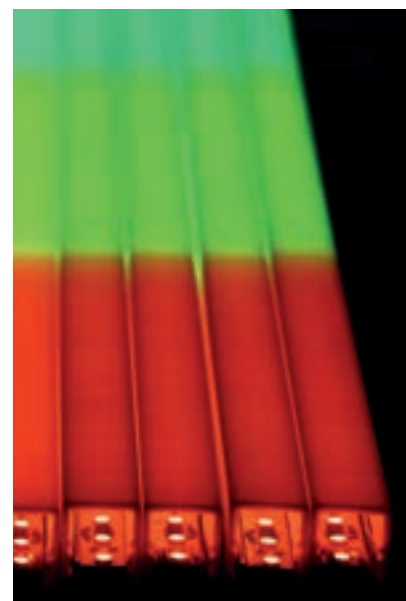

16 LEDs x Pixel



Ci-après sont listées des instructions relatives au dimensionnement du pixel-pitch.

Les calculs et exemples suivants constituent des lignes directrices générales pour la détermination des distances minimale et maximale de visionnage dans le cas d'un affichage d'une vidéo basse résolution avec Paseo_PIXEL RGB.

- Pour déterminer la distance minimale de visionnage, multiplier le pixel-pitch par 100. Par exemple : si le pixel-pitch mesure 36 mm, la distance de visionnage minimale est de 3,6 m.
- Pour déterminer la distance maximale permettant de distinguer l'image, multiplier la hauteur de l'écran par 20. Par exemple : si l'écran mesure 30 m de haut, la distance de visionnage maximale sera de 600 m.
- Les affichages à LED sont visibles au-delà de la distance maximale permettant de distinguer l'image. Pour déterminer la distance de visionnage maximale pour un impact visuel adéquat, multiplier la hauteur de l'écran par 50. Par exemple : un écran mesurant 20 m de haut maintiendra un impact visuel jusqu'à 1000 m d'éloignement.

Il est cependant possible d'obtenir un bon impact visuel jusqu'à une distance égale à 50 fois la hauteur de l'écran, y compris au-delà de la distance de visionnage maximale mentionnée au point précédent.



Underwater

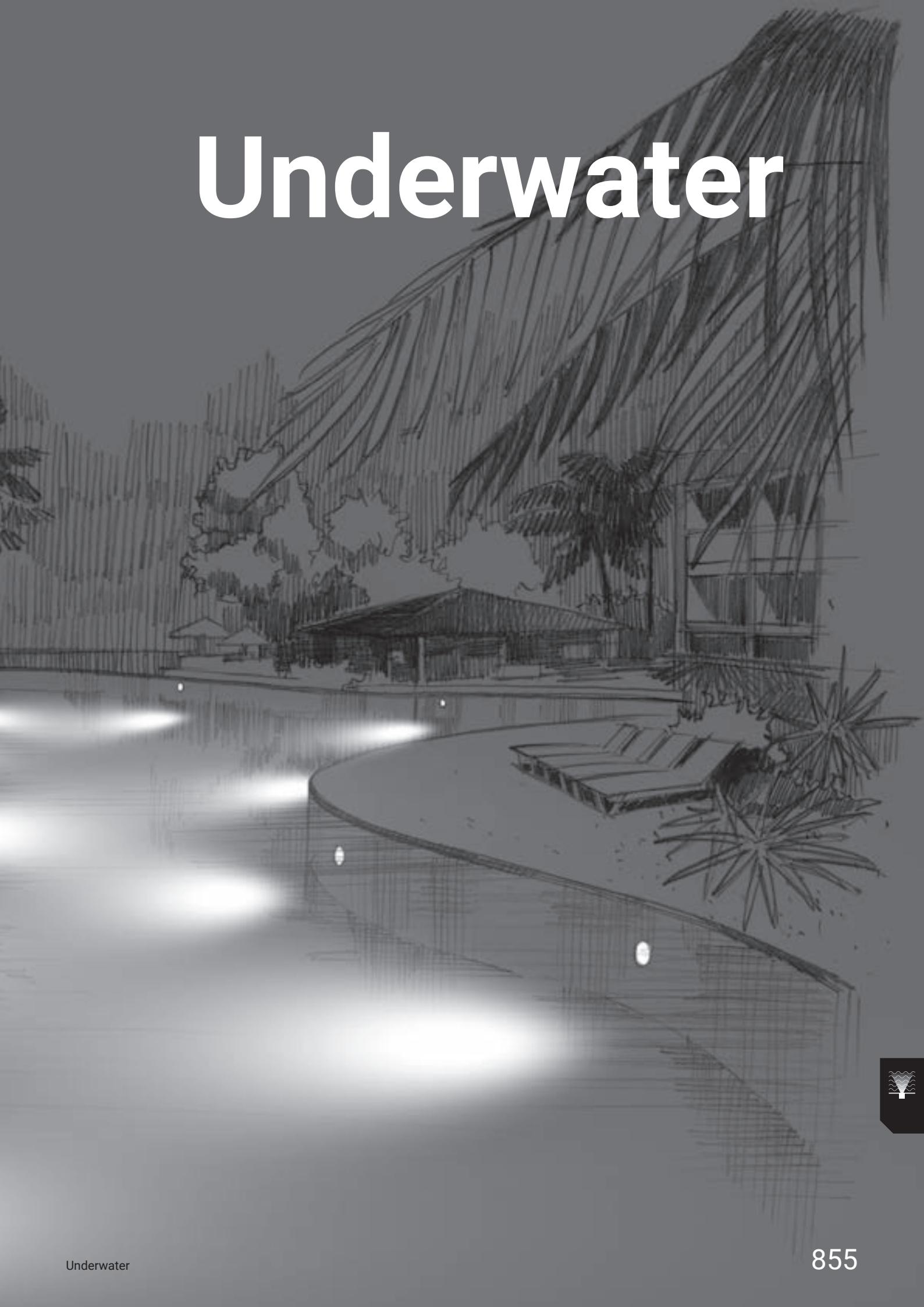

underwater range index

Nautilus

Nautilus_RF



864

Nautilus_R



866

Nautilus_RP

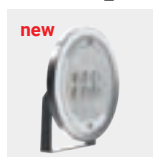

868

Suelo

Suelo_R



871

Suelo_R Pro



871

MK68

MK68_R



873

MK68_Q



873

Sub

Sub_R



875

Sub_Q



875

Rodix

Rodix



877

Rubber

Rubber 3D
PROtection



880









nautilus

Matériaux

Corps en inox AISI 316L



nautilus range



	Nautilus_RF	Nautilus_R	Nautilus_RP
4W	-	-	Ø 55 mm
4,5W	Ø 108 mm	-	-
6W	-	-	Ø 134 mm
14W	Ø 148 mm	Ø 145 mm	Ø 134 mm
26W	Ø 230 mm	Ø 226 mm	Ø 214 mm
38W	Ø 230 mm	Ø 226 mm	Ø 214 mm
Finish	Steel	Steel	Steel
CCT	3000K 4000K RGBW	3000K 4000K RGBW	3000K 4000K RGBW
Optics	Spot - Flood - Elliptic - Asymm. - Mix Flux	Spot - Flood - Elliptic - Asymm. - Mix Flux	Spot - Flood - Wide Flood - Elliptic
Driver	On/Off	On/Off	On/Off

Nautilus

Le design sobre de Nautilus, souligné par un cadre rigoureux en acier, est plat pour les structures en béton ou bombé pour les structures avec bêche. Le diffuseur en verre trempé ultra clair, avec un bord sérigraphié blanc est donc invisible une fois immergé. Le système breveté « anti-aspiration », qui préserve des infiltrations, des émissions asymétriques vers le bas pour une distribution optimale de la lumière, et la possibilité de combiner et de commander indépendamment différentes optiques sont des avantages supplémentaires. Tous les modèles utilisent des sources blanches de 3000 ou 4000 K ou RGBW pour créer des décors surprenants.

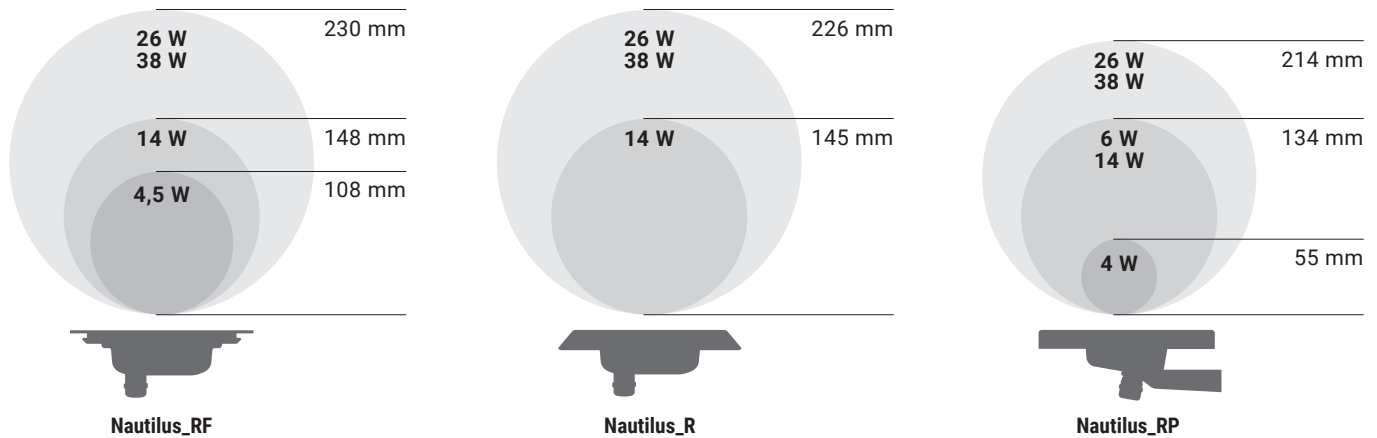

Nautilus descend jusqu'à 25 mètres

Nautilus est un spot encastrable pour immersion IP68, idéal pour créer des décors évocateurs sous l'eau. Le boîtier d'encastrement est étanche grâce à la bride de fixation en acier inoxydable AISI 316, et peut donc être positionné au mur ou au sol. La structure spéciale confère au projecteur une capacité de résistance qui va jusqu'à 25 mètres de profondeur.

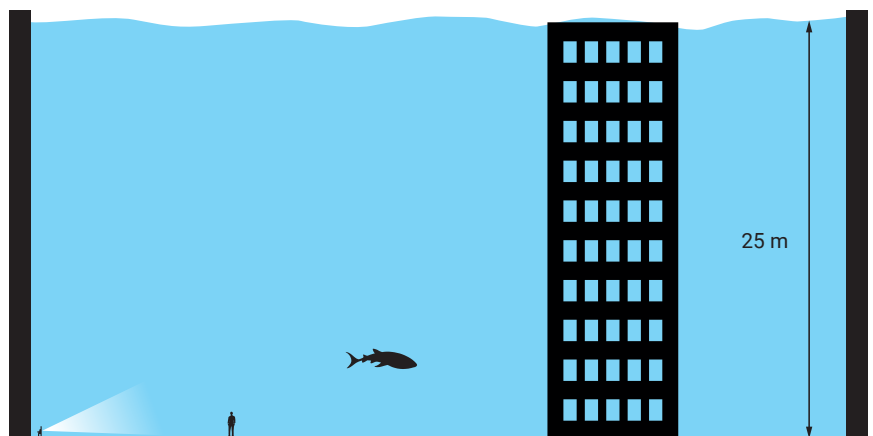

Nouvelles optiques

Les nouvelles optiques augmentent considérablement la versatilité et la fonctionnalité de Nautilus. Les optiques fixes, Spot, Flood, Elliptic, Asymmetric + wall-washer sont positionnées côte à côte, pour les versions de 6 et 9 LED : deux nouvelles typologies dénommées Mixflux, Asymmetric + wall-washer e Asymmetric + Spot, qui grâce aux protocoles DALI et DMX peuvent être commandées de manière indépendante, en multipliant les possibilités de création pour le concepteur de projet.

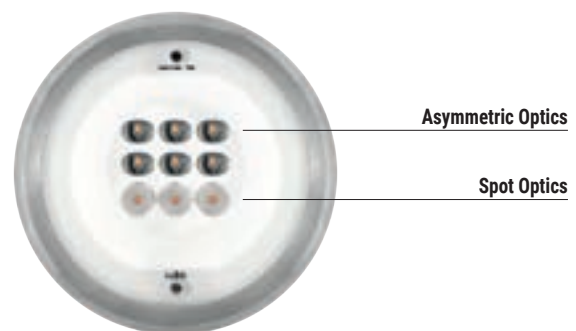

Example: Spot beam on

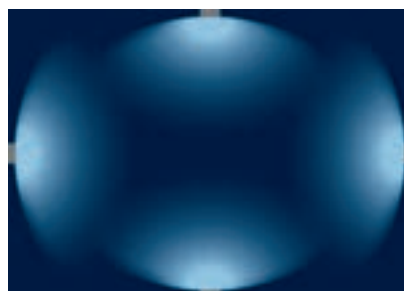

Example: Asymmetric beam on

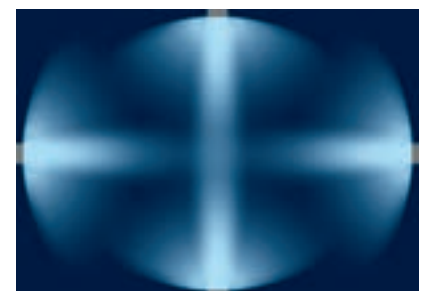

Example: Mix Fluxed double beam on

Nautilus_RF | Underwater luminaires | powerLED 4,5W DC

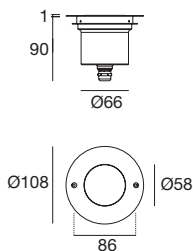

CV 12V DC	Cct	lm S - D	Optic
Steel 84031	W 3000	575 -	20 Spot -
	N 4000	620 -	40 Flood -
			07 Asymm. -
			25 Elliptic -

Électronique

83010	83013
ON/OFF 1 art. p 150 x 160 x h 35	ON/OFF 1 - 3 art. p 150 x 160 x h 35

Dimmable on request

RGBW	Optic
Steel 84032	Q RGBW natural white
	V RGBW warm white
	20 Spot -
	40 Flood -
	07 Asymm. -
	25 Elliptic -

Électronique 12V DC

99741 + 99702	83187	DMX	83010
Dimmer RF 1 - 4 art.	Dimmer DMX 1 - 4 art.	Controllers Pag 952 - 953	Driver CV 12V 60W

Électronique 24V DC

99741 + 99702	83187	DMX	99331
Dimmer RF 1 - 8 art.	Dimmer DMX 1 - 8 art.	Controllers Pag 952 - 953	Driver CV 24V 150W DC

Boîtier d'encastrement Pag. 865

Available from April 2021

RTG 84031W20 / 84032V40

Nautilus_RF | Underwater luminaires | powerLEDs 14W DC

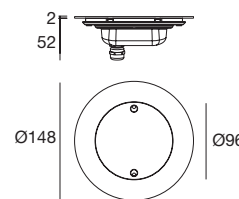

CV 12V DC	Cct	lm S - D	Optic
Steel 84033	W 3000	1521 -	20 Spot -
	N 4000	1640 -	40 Flood -
			07 Asymm. -
			25 Elliptic -

Électronique

83010	83013
ON/OFF 1 art. p 150 x 160 x h 35	ON/OFF 1 - 3 art. p 150 x 160 x h 35

Dimmable on request

RGBW	Optic
Steel 84034	Q RGBW natural white
	V RGBW warm white
	20 Spot -
	40 Flood -
	07 Asymm. -
	25 Elliptic -

Électronique 12V DC

99741 + 99702	83187	DMX	83010
Dimmer RF 1 art.	Dimmer DMX 1 art.	Controllers Pag 952 - 953	Driver CV 12V 60W DC

Électronique 24V DC

99741 + 99702	83187	DMX	99331
Dimmer RF 1 - 2 art.	Dimmer DMX 1 - 2 art.	Controllers Pag 952 - 953	Driver CV 24V 150W DC

Boîtier d'encastrement Pag. 865

Available from April 2021

Nautilus_RF | Underwater luminaires | powerLEDs 26W DC

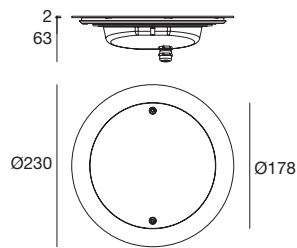

CV 12V DC	Cct	lm S - D	Optic
Steel 84037	W 3000	3042 -	20 Spot -
	N 4000	3281 -	40 Flood -
			07 Asymm. -
			25 Elliptic -
			31 Mix Flux (07+25)
			32 Mix Flux (07+20)

Électronique

83010	83013	Dimmable on request
ON/OFF 1 art. p 150 x l 60 x h 35	ON/OFF 1 - 3 art. p 150 x l 60 x h 35	

RGBW	Optic
Steel 84039	Q RGBW natural white
	V RGBW warm white
	20 Spot -
	40 Flood -
	07 Asymm. -
	25 Elliptic -
	31 Mix Flux (07+25)
	32 Mix Flux (07+20)

Électronique 12V DC

99743 + 99702	83187	DMX	99331
Dimmer RF 1 art.	Dimmer DMX 1 art.	Controllers Pag 952 - 953	Driver CV 12V 60W DC

Électronique 24V DC

99743 + 99702	83187	DMX	99331
Dimmer RF 1 - 2 art.	Dimmer DMX 1 - 2 art.	Controllers Pag 952 - 953	Driver CV 24V 150W DC

Boîtier d'encastrement Pag. 865

Available from April 2021

Nautilus_RF | Underwater luminaires | powerLEDs 38W DC

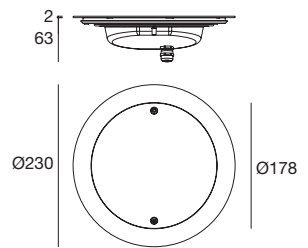

CV 12V DC	Cct	lm S - D	Optic
Steel 84038	W 3000	4563 -	20 Spot -
	N 4000	4921 -	40 Flood -
			07 Asymm. -
			25 Elliptic -
			31 Mix Flux (07+25)
			32 Mix Flux (07+20)

Électronique

83010	83013	Dimmable on request
ON/OFF 1 art. p 150 x l 60 x h 35	ON/OFF 1 - 3 art. p 150 x l 60 x h 35	

RGBW	Optic
Steel 84040	Q RGBW natural white
	V RGBW warm white
	20 Spot -
	40 Flood -
	07 Asymm. -
	25 Elliptic -
	31 Mix Flux (07+25)
	32 Mix Flux (07+20)

Électronique 12V DC

83187	DMX	83010
Dimmer DMX 1 art.	Controllers Pag 952 - 953	Driver CV 12V 60W DC

Électronique 24V DC

83187	DMX	99331
Dimmer DMX 1 - 2 art.	Controllers Pag 952 - 953	Driver CV 24V 150W DC

Boîtier d'encastrement Pag. 865

Available from April 2021

Boîtier d'encastrement



description	PVC
83140 Boîtier d'encastrement	IP68
suitable for: Nautilus_RF 4,5W	
RTG 83140	



description	PVC
83142 Encastrement pour installation en maçonnerie	IP68
83198 Encastrement pour installation sur un plafond tendu	IP68
suitable for: Nautilus_RF 26W / Nautilus_RF 38W	



description	PVC
83141 Encastrement pour installation en maçonnerie	IP68
83197 Encastrement pour installation sur un plafond tendu	IP68
suitable for: Nautilus_RF 14W	

Nautilus_R | Underwater luminaires | powerLEDs 14W DC

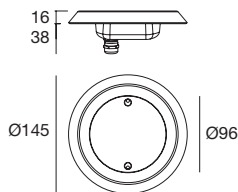

CV 12V DC	Cct	lm S - D	Optic
Steel 84035	W 3000	1521 -	20 Spot -
	N 4000	1640 -	40 Flood -
			07 Asymm. -
			25 Elliptic -

Électronique

83010	83013	Dimmable on request
ON/OFF 1 art. p 150 x 160 x h 35	ON/OFF 1 - 3 art. p 150 x 160 x h 35	

RGBW	Optic
Steel 84036	Q RGBW natural white
	V RGBW warm white
	20 Spot -
	40 Flood -
	07 Asymm. -
	25 Elliptic -

Électronique 12V DC

99741 + 99702	83187	DMX	83010
Dimmer RF 1 art.	Dimmer DMX 1 art.	Controllers Pag 952 - 953	Driver CV 12V 60W DC

Électronique 24V DC

99741 + 99702	83187	DMX	99331
Dimmer RF 1 - 2 art.	Dimmer DMX 1 - 2 art.	Controllers Pag 952 - 953	Driver CV 24V 150W DC

Boîtier d'encastrement Pag. 867

Available from April 2021

Nautilus_R | Underwater luminaires | powerLEDs 26W DC

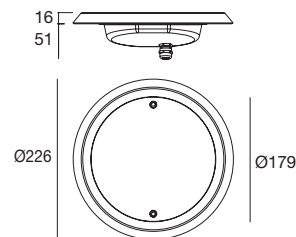

CV 12V DC	Cct	lm S - D	Optic
Steel 84041	W 3000	3042 -	20 Spot -
	N 4000	3281 -	40 Flood -
			07 Asymm. -
			25 Elliptic -
			31 Mix Flux (07+25)
			32 Mix Flux (07+20)

Électronique

83010	83013	Dimmable on request
ON/OFF 1 art. p 150 x 160 x h 35	ON/OFF 1 - 3 art. p 150 x 160 x h 35	

RGBW	Optic
Steel 84043	Q RGBW natural white
	V RGBW warm white
	20 Spot -
	40 Flood -
	07 Asymm. -
	25 Elliptic -
	31 Mix Flux (07+25)
	32 Mix Flux (07+20)

Électronique 12V DC

99743 + 99702	83187	DMX	99331
Dimmer RF 1 art.	Dimmer DMX 1 art.	Controllers Pag 952 - 953	Driver CV 12V 60W DC

Électronique 24V DC

99743 + 99702	83187	DMX	99331
Dimmer RF 1 - 2 art.	Dimmer DMX 1 - 2 art.	Controllers Pag 952 - 953	Driver CV 24V 150W DC

Boîtier d'encastrement Pag. 867

Available from April 2021

Nautilus_R | Underwater luminaires | powerLEDs 38W DC

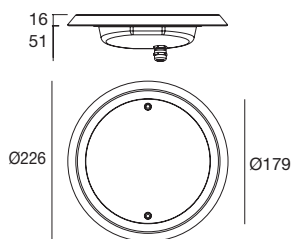

CV 12V DC	Cct	lm S - D	Optic
Steel 84042	W 3000	4563 -	20 Spot -
	N 4000	4921 -	40 Flood -
			07 Asymm. -
			25 Elliptic -
			31 Mix Flux (07+25)
			32 Mix Flux (07+20)

Électronique

83010	83013	Dimmable on request
ON/OFF 1 art. p 150 x 160 x h 35	ON/OFF 1 - 3 art. p 150 x 160 x h 35	

RGBW	Optic
Steel 84044	20 Spot -
Q RGBW natural white	40 Flood -
V RGBW warm white	07 Asymm. -
	25 Elliptic -
	31 Mix Flux (07+25)
	32 Mix Flux (07+20)

Électronique 12V DC

83187	DMX	83010
Dimmer DMX 1 art.	Controllers Pag 952 - 953	Driver CV 12V 60W DC

Électronique 24V DC

83187	DMX	99331
Dimmer DMX 1 - 2 art.	Controllers Pag 952 - 953	Driver CV 24V 150W DC

Boîtier d'encastrement Pag. 867

Available from April 2021

Boîtier d'encastrement



	description	PVC
83141	Encastrement pour installation en maçonnerie	IP68
83197	Encastrement pour installation sur un plafond tendu	IP68

suitable for: Nautilus_R 14W



	description	PVC
83142	Encastrement pour installation en maçonnerie	IP68
83198	Encastrement pour installation sur un plafond tendu	IP68

suitable for: Nautilus_R 26W / Nautilus_R 38W

Nautilus_RP | Underwater luminaires | powerLED 4W DC 350 mA

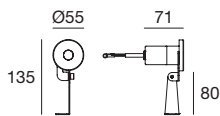

		Cct	lm S - D	Optic
Steel	80314	W 3000	490 - On req	15 Spot
		N 4000	529 - On req	30 Flood
				60 W.Flood

Électronique

89421	99183	83100
ON/OFF 1 art. p 65 x l 74 x h 27	ON/OFF 1 - 2 art. p 80 x l 100 x h 31	DALI 1 - 4 art. p 54 x l 121 x h 26

Available from April 2021

Nautilus_RP | Underwater luminaires | powerLEDs

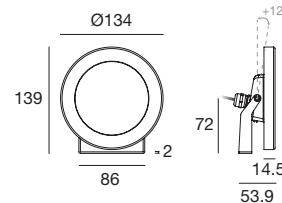

		Cct	lm S - D	Optic
Steel	84193	W 3000	945 - On req	20 Spot -
		N 4000	1019 - On req	40 Flood -
				25 Elliptic -

Électronique

83010	83013
ON/OFF 1 art. p 150 x l 60 x h 35	ON/OFF 1 - 3 art. p 150 x l 60 x h 35

Dimmable on request

			Optic
Steel	84194	Q RGBW natural white	20 Spot -
		V RGBW warm white	40 Flood -
			25 Elliptic -

Électronique

99741 + 99702	83187	DMX	83010
Dimmer RF 1 art.	Dimmer DMX 1 art.	Controllers Pag 952 - 953	Driver CV 12V 60W DC

		Cct	lm S - D	Optic
Steel	84025	W 3000	1521 - On req	20 Spot -
		N 4000	1640 - On req	40 Flood -
				25 Elliptic -

Électronique

83010	83013
ON/OFF 1 art. p 150 x l 60 x h 35	ON/OFF 1 - 3 art. p 150 x l 60 x h 35

Dimmable on request

			Optic
Steel	84026	Q RGBW natural white	20 Spot -
		V RGBW warm white	40 Flood -
			25 Elliptic -

Électronique

99741 + 99702	83187	DMX	83010
Dimmer RF 1 art.	Dimmer DMX 1 art.	Controllers Pag 952 - 953	Driver CV 12V 60W DC

Available from April 2021

Nautilus_RP | Underwater luminaires | powerLEDs 26W DC

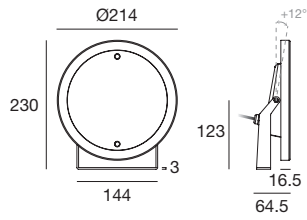

C.V. 12V DC	Cct	lm S - D	Optic
Steel 84027	W 3000	3042 - On req	20 Spot -
	N 4000	3281 - On req	40 Flood -
			25 Elliptic -

Électronique

83010	83013
ON/OFF 1 art. p 150 x 160 x h 35	ON/OFF 1-3 art. p 150 x 160 x h 35

**Dimmable
on request**

C.C. RGBW	Optic
Steel 84029	Q RGBW natural white 20 Spot -
	V RGBW warm white 40 Flood -
	25 Elliptic -

Électronique 12V DC

99743 + 99702	83187	DMX	99331
Dimmer RF 1 art.	Dimmer DMX 1 art.	Controllers Pag 952 - 953	Driver CV 12V 60W DC

Électronique 24V DC

99743 + 99702	83187	DMX	99331
Dimmer RF 1-2 art.	Dimmer DMX 1-2 art.	Controllers Pag 952 - 953	Driver CV 24V 150W DC

Available from April 2021

Nautilus_RP | Underwater luminaires | powerLEDs 38W DC

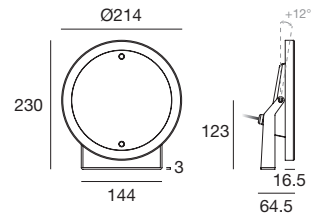

C.V. 12V DC	Cct	lm S - D	Optic
Steel 84028	W 3000	4563 - On req	20 Spot -
	N 4000	4921 - On req	40 Flood -
			25 Elliptic -

Électronique

83010	83013
ON/OFF 1 art. p 150 x 160 x h 35	ON/OFF 1-3 art. p 150 x 160 x h 35

**Dimmable
on request**

C.C. RGBW	Optic
Steel 84030	Q RGBW natural white 20 Spot -
	V RGBW warm white 40 Flood -
	25 Elliptic -

Électronique 12V DC

83187	DMX	83010
Dimmer DMX 1 art.	Controllers Pag 952 - 953	Driver CV 12V 60W DC

Électronique 24V DC

83187	DMX	99331
Dimmer DMX 1-2 art.	Controllers Pag 952 - 953	Driver CV 24V 150W DC

Available from April 2021

suelo

Matériaux

Corps en inox AISI 316L

Suelo_R | Up-Light | 1 W powerLED 350mA

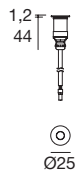

C.C.	Cct	lm S - D	Optic
Steel 80432	M 2700	136 - 104	20 Flood (26°)
	W 3000	145 - 111	35 Flood (36°)
	N 4000	155 - 119	

Électronique

89419	89421	99183	83100
ON/OFF 1 - 2 art. p 65 x l 74 x h 27	ON/OFF 3 - 6 art. p 65 x l 74 x h 27	ON/OFF 6 - 12 art. p 80 x l 1100 x h 31	DALI 1 - 14 art. p 54 x l 121 x h 26

Boîtier d'encastrement Pag. 871

Suelo_R Pro | Up-Light | powerLED

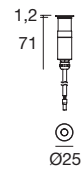

C.C. - 350 mA - 1W DC	Cct	lm S - D	Optic
Steel 80433	M 2700	136 - 96	20 Flood (23°)
	W 3000	145 - 102	35 Flood (34°)
	N 4000	155 - 110	

Électronique

89419	89421	99183	83100
ON/OFF 1 - 2 art. p 65 x l 74 x h 27	ON/OFF 3 - 6 art. p 65 x l 74 x h 27	ON/OFF 6 - 12 art. p 80 x l 1100 x h 31	DALI 1 - 14 art. p 54 x l 121 x h 26

C.V. - 24V DC - 1,5W DC

Cct	lm S - D	Optic
Steel 80434	M 2700	136 - 96
	W 3000	145 - 102
	N 4000	155 - 110

Électronique

89488	89179	89359	99332	99722
ON/OFF 1 - 9 art. p 80 x l 100 x h 31	ON/OFF 1 - 15 art. p 92 x l 117 x h 38	ON/OFF 1 - 30 art. p 115 x l 140 x h 50	0/1-10V 1 - 98 art. p 150 x l 160 x h 35	DALI 1 - 78 art. p 191 x l 163 x h 38

Boîtier d'encastrement Pag. 871

Boîtier d'encastrement

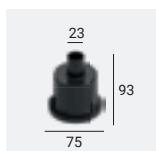

description	PVC
99678 Boîtier d'encastrement IP68	IP68
suitable for: Suelo_R	



description	PVC
99679 Boîtier d'encastrement IP68	IP68
suitable for: Suelo_R Pro	

Underwater

MK68

Matériaux

Corps en polycarbonate

Éléments de fermeture en inox AISI 316L/polycarbonate



MK68_R | Underwater luminaires | 12 V DC | topLED

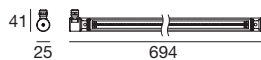

694 mm - 11W DC	Cct	lm S - D	Optic
Transp. 82642	W 3000	1470 - On req	36 Diffused
	N 4000	1538 - On req	
	C 6000	1538 - On req	

694 mm - 11W DC	Cct	lm S - D	Optic
Opaline 82646	W 3000	1470 - On req	00 General
	N 4000	1538 - On req	
	C 6000	1538 - On req	

Électronique

83010	83013	83012	83015
ON/OFF 1 - 5 art. p 150 x l 60 x h 35	ON/OFF 1 - 13 art. p 150 x l 60 x h 35	DALI 1 - 5 art. p 191 x l 63 x h 38	DALI 1 - 10 art. p 220 x l 71 x h 38

1290 mm - 20W DC	Cct	lm S - D	Optic
Transp. 82644	W 3000	2940 - On req	36 Diffused
	N 4000	3076 - On req	
	C 6000	3076 - On req	

1290 mm - 20W DC	Cct	lm S - D	Optic
Opaline 82648	W 3000	2940 - On req	00 General
	N 4000	3076 - On req	
	C 6000	3076 - On req	

Électronique

83010	83013	83012	83015
ON/OFF 1 - 3 art. p 150 x l 60 x h 35	ON/OFF 1 - 7 art. p 150 x l 60 x h 35	DALI 1 - 3 art. p 191 x l 63 x h 38	DALI 1 - 6 art. p 220 x l 71 x h 38

Accessoires

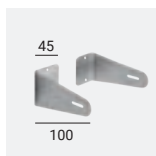

description	
83020	Boîtier d'encastrement
suitable for: MK68_R / MK68_Q	

ZeroAir system

Grâce à son expérience en conception de luminaires immergeables, Linea Light group a su breveter un système spécial nommé ZeroAir, qui permet d'empêcher de manière définitive la formation d'humidité à l'intérieur du produit, et ce, afin de protéger le circuit LED de la condensation.



Underwater

MK68_Q | Underwater luminaires | 12 V DC | topLED

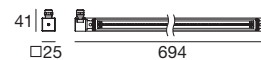

694 mm - 11W DC	Cct	lm S - D	Optic
Transp. 82650	W 3000	1470 - On req	36 Diffused
	N 4000	1538 - On req	
	C 6000	1538 - On req	

694 mm - 11W DC	Cct	lm S - D	Optic
Opaline 82654	W 3000	1470 - On req	00 General
	N 4000	1538 - On req	
	C 6000	1538 - On req	

Électronique

83010	83013	83012	83015
ON/OFF 1 - 5 art. p 150 x l 60 x h 35	ON/OFF 1 - 13 art. p 150 x l 60 x h 35	DALI 1 - 5 art. p 191 x l 63 x h 38	DALI 1 - 10 art. p 220 x l 71 x h 38

1290 mm - 20W DC	Cct	lm S - D	Optic
Transp. 82652	W 3000	2205 - On req	36 Diffused
	N 4000	2307 - On req	
	C 6000	2307 - On req	

1290 mm - 20W DC	Cct	lm S - D	Optic
Opaline 82656	W 3000	2940 - On req	00 General
	N 4000	3076 - On req	
	C 6000	3076 - On req	

Électronique

83010	83013	83012	83015
ON/OFF 1 - 3 art. p 150 x l 60 x h 35	ON/OFF 1 - 7 art. p 150 x l 60 x h 35	DALI 1 - 3 art. p 191 x l 63 x h 38	DALI 1 - 6 art. p 220 x l 71 x h 38

MK68 descend jusqu'à 25 mètres

La structure spéciale confère au MK68 une capacité de résistance qui va jusqu'à 25 mètres de profondeur.

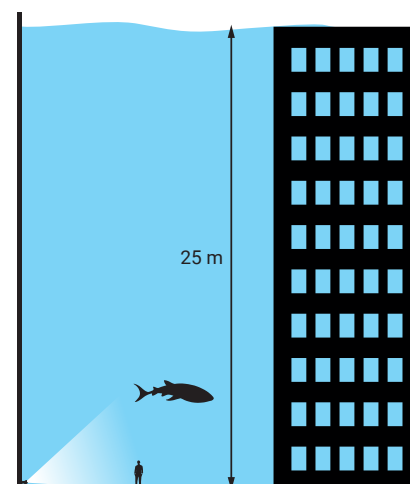

sub

Matériaux

Corps en inox AISI 316L

Sub_R | Underwater luminaires | powerLED 1.5W DC 500 mA

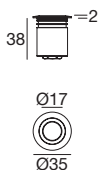

	Cct	lm S - D	Optic
Steel 97315	M 2700	187 - On req	15 Spot (19°)
	W 3000	199 - 161	30 Flood (25°)
	N 4000	213 - 171	60 W.Flood (50°)
			00 General (116°)

Électronique

89422	89423	99181	99185	83101
ON/OFF 1 - 2 art. p 65 x l 74 x h 27	ON/OFF 2 - 3 art. p 65 x l 74 x h 27	ON/OFF 3 - 6 art. p 80 x l 100 x h 31	ON/OFF 6 - 12 art. p 92 x l 117 x h 38	DALI 1 - 12 art. p 54 x l 121 x h 26

Boîtier d'encastrement Pag. 875

RTG 97315W15 / 97315W30 / 97315W60 / 97315W00 / 97315N30

Sub_Q | Underwater luminaires | powerLED 1.5W DC 500 mA

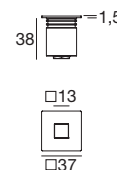

	Cct	lm S - D	Optic
Steel 97317	M 2700	187 - On req	15 Spot (19°)
	W 3000	199 - 161	30 Flood (25°)
	N 4000	213 - 171	60 W.Flood (50°)
			00 General (116°)

Électronique

89422	89423	99181	99185	83101
ON/OFF 1 - 2 art. p 65 x l 74 x h 27	ON/OFF 2 - 3 art. p 65 x l 74 x h 27	ON/OFF 3 - 6 art. p 80 x l 100 x h 31	ON/OFF 6 - 12 art. p 92 x l 117 x h 38	DALI 1 - 12 art. p 54 x l 121 x h 26

Boîtier d'encastrement Pag. 875

Boîtier d'encastrement



	description	PVC
98148	Boîtier d'encastrement IP68	IP68
	suitable for: Sub_R / Sub_Q	
RTG 98148		

Underwater



	description	PVC
98060	Boîtier d'encastrement	
	suitable for: Sub_R / Sub_Q	
RTG 98060		

rodix

Matériaux

Corps en inox AISI 316

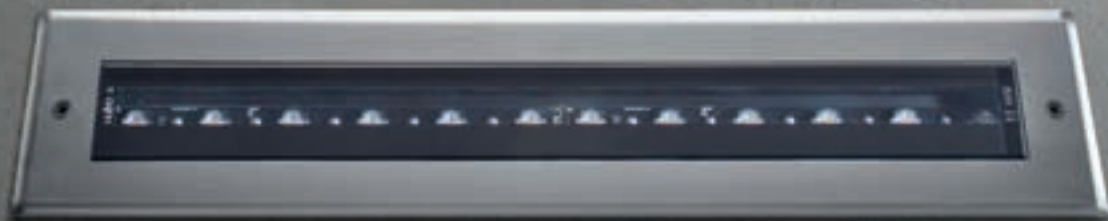

Rodix | Underwater luminaires | 198-264V AC | powerLEDs



12W DC - 13W AC	Cct	lm S - D	Optic
Steel 84212	M 2700	1398 - On req	15 Spot -
	W 3000	1494 - On req	30 Flood -
	N 4000	1494 - On req	60 W.Flood -
			07 Asymm. -

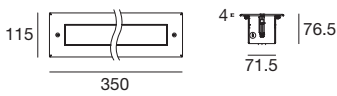

24W DC - 26W AC	Cct	lm S - D	Optic
Steel 84213	M 2700	2796 - On req	15 Spot -
	W 3000	2988 - On req	30 Flood -
	N 4000	2998 - On req	60 W.Flood -
			07 Asymm. -

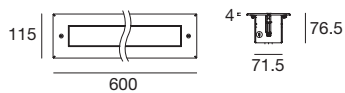

Boîtier d'encastrement Pag. 877

Boîtier d'encastrement

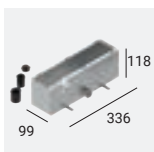

description	Steel
83160 336 mm	
suitable for: Rodix 12W	

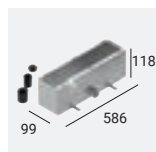

description	Steel
83161 586 mm	
suitable for: Rodix 24W	



rubber

Matériaux

Corps en technopolymère

Diffuseur en résine polyuréthane

Rubber 3D PROtection

IP68 et immersion permanente

Rubber 3D PROtection détient la certification de classe IP68, et se prête à des installations permanentes allant jusqu'à 3 mètres d'immersion, telles que dans les piscines, les fontaines, les cascades verticales, les douches modernes et bien d'autres encore, en garantissant un maximum de flexibilité. De plus, le câble d'alimentation étanche permet une protection contre l'eau. Longueur de 5 mètres, bien plus que la moyenne si l'on tient compte des produits similaires en vente sur le marché, le câble permet de placer l'alimentation dans un logement séparé pour aider l'installateur, et faciliter l'entretien ultérieur de Rubber, et/ou les éventuels remplacements.

IP68



IP69

IP69 est une classification de la norme allemande DIN 40050-9 qui étend la classification standard IP, développée pour les secteurs qui nécessitent une protection supplémentaire contre les hautes pressions et les températures élevées. Rubber 3D PROtection a réussi le test IP69 : une fois installé dans la piscine ou dans d'autres lieux où il est nécessaire de nettoyer périodiquement avec un nettoyeur haute pression, Rubber PROtection résiste aux jets de vapeur ou d'eau chaude à haute pression dirigés directement sur le produit sans qu'il soit nécessaire de le retirer et de le replacer ensuite. Un avantage considérable qui permet d'éviter les opérations de manutention obligatoires et répétées. IP69 est un complément à la classification de la norme IP68 institué par le système IEC60529. Rubber 3D PROtection est certifié pour les deux indices de protection.

 High Temperature 80°C
High Pressure 80/100 bar

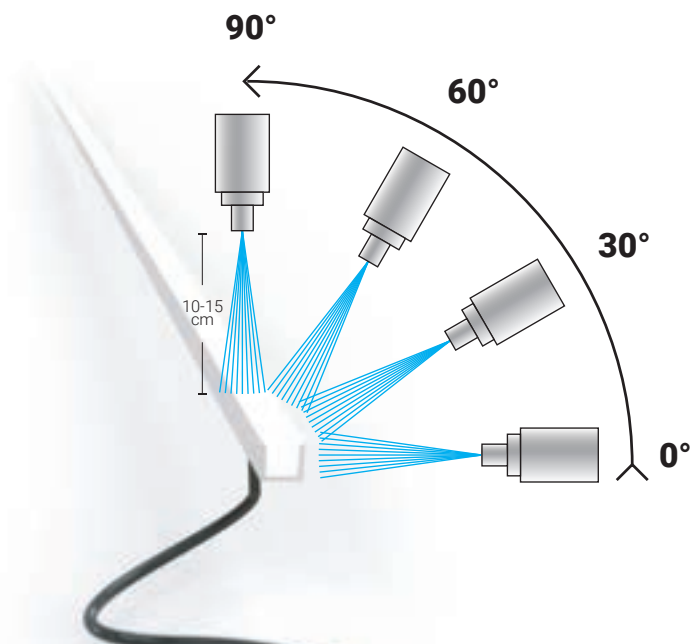

Rubber 3D PROtection | LED strip | 10W/m 24V DC



CRI 85	Cct	lm S - D	
White 80415	2700	1020 - 455	1 m
White 80416	3000	1100 - 506	1 m
White 80417	4000	1190 - 674	1 m

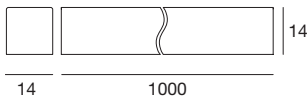

Électronique

89179	89359	99331	83019	99332	99722
ON/OFF 1 - 2 art. p 92 x l 117 x h 38	ON/OFF 1 - 4 art. p 115 x l 140 x h 50	ON/OFF 1 - 15 art. p 150 x l 60 x h 35	PUSH 1 - 15 art. p 150 x l 60 x h 35	0/1-10V 1 - 15 art. p 150 x l 60 x h 35	DALI 1 - 12 art. p 191 x l 63 x h 38

CRI 85	Cct	lm S - D	
White 99543	2700	5100 - 2275	5 m
White 99544	3000	5500 - 2528	5 m
White 99545	4000	5950 - 3370	5 m

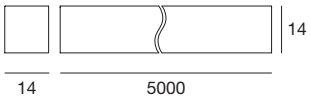

Électronique

99331	83019	99332	99722	99787
ON/OFF 1 - 3 art. p 150 x l 60 x h 35	PUSH 1 - 3 art. p 150 x l 60 x h 35	0/1-10V 1 - 3 art. p 150 x l 60 x h 35	DALI 1 - 2 art. p 191 x l 63 x h 38	DALI 1 - 4 art. p 191 x l 63 x h 38

RTG 80416 / 80417 / 99544 / 99545

Accessoires Pag. 881

Rubber 3D PROtection | LED strip | 16,5 W/m 24V DC



White 80730	RGBW (3000K)	1 m
-------------	--------------	-----

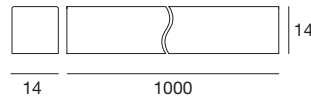

Électronique

99696+ 99702	99331	99278	DMX	99331
Dimmer RF CV 24V 150 W p 150 x l 60 x h 35	CV 24V 150 W p 150 x l 60 x h 35	Dimmer DMX	DMX Controllers Pag. 952 - 953	CV 24V 150 W p 150 x l 60 x h 35

White 80731	RGBW (3000K)	5 m
-------------	--------------	-----

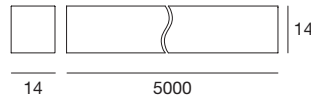

Électronique

99696+ 99702	99331	99278	DMX	99331
Dimmer RF CV 24V 150 W p 150 x l 60 x h 35	CV 24V 150 W p 150 x l 60 x h 35	Dimmer DMX	DMX Controllers Pag. 952 - 953	CV 24V 150 W p 150 x l 60 x h 35

RTG 80730 / 80731

Accessoires Pag. 881

Accessoires

Rubber | Profil linéaire



	description	PVC
80418	1000 mm/ 18 mm/ 19 mm	
suitable for: Rubber 3D PROtection		

Rubber | Profil linéaire avec passage de câble

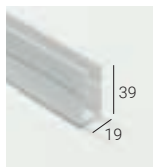

	description	PVC
80419	1000 mm/ 39 mm/ 19 mm	
suitable for: Rubber 3D PROtection		

Rubber | Clip

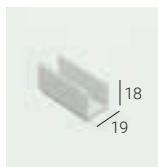

	description	PVC
80733	50 mm/ 18 mm/ 19 mm	
suitable for: Rubber 3D PROtection		

Rubber | Clip avec passage de câble

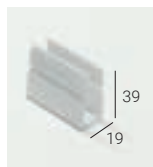

	description	PVC
80734	50 mm/ 39 mm/ 19 mm	
suitable for: Rubber 3D PROtection		

Rubber | Boîtier d'encastrement



	description
98148	
suitable for: Rubber 3D PROtection	

Rubber | Ruban adhésif double face



	description
99520	33 m
suitable for: Rubber 3D PROtection	

Rubber | Connecteur

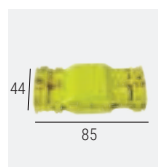

	description
89548	
suitable for: Rubber 3D PROtection	

Rubber | Connecteur







	description
98990	
suitable for: Rubber 3D PROtection	







RTG 98148 / 99520 / 89548

flex light range index



Rubber

Rubber_2D	Rubber 3D	Rubber 3D Optics	Rubber 3D Protection	Accessories
new  Mado in Italy	new  Mado in Italy	new  Mado in Italy	new  Mado in Italy	new 
890	892	893	878	894





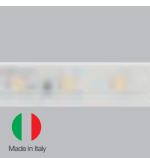
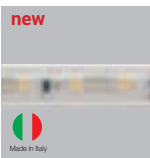
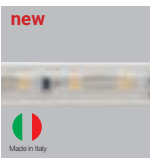

Ribbon Plus

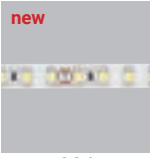

Ribbon Plus 70	Ribbon Plus Hi-Flux	Ribbon Plus 140	Ribbon Plus WT	Ribbon Plus Dynamic	Ribbon Plus RGBW
 Mado in Italy	 Mado in Italy	 Mado in Italy	 Mado in Italy	 Mado in Italy	 Mado in Italy
900	900	900	901	901	901

PU_C

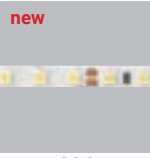

PU_C Plus 70	PU_C Plus Hi-Flux	PU_C Plus 140	PU_C Plus 140 Hi-Flux	PU_C RGBW 60
 Mado in Italy	 Mado in Italy	new  Mado in Italy	new  Mado in Italy	new  Mado in Italy
902	902	902	902	903

Ribbon



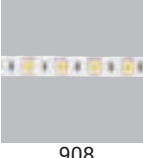

Ribbon Basic 60	Ribbon Hi-Flux	Ribbon 120	Ribbon 240	Ribbon Slim	Ribbon Hi-Flux 150
 Mado in Italy	 Mado in Italy	new  Mado in Italy	 Mado in Italy	new  Mado in Italy	new  Mado in Italy
906	906	906	906	906	907

Ribbon Dynamic	Ribbon RGB	Ribbon RGBW
 Mado in Italy	 Mado in Italy	new  Mado in Italy
907	907	907

Dropper

Dropper Basic	Dropper Hi-Flux	Dropper 120	Dropper RGB
 Mado in Italy	 Mado in Italy	 Mado in Italy	 Mado in Italy
908	908	908	908

Silicone_C

Silicone_C Basic	Silicone_C Hi-Flux	Silicone_C 120	Silicone_C RGB
new  Mado in Italy	 Mado in Italy	 Mado in Italy	 Mado in Italy
909	909	909	909

Accessories

Accessories



912





rubber

Matériaux

Corps en technopolymère

Diffuseur en résine polyuréthane



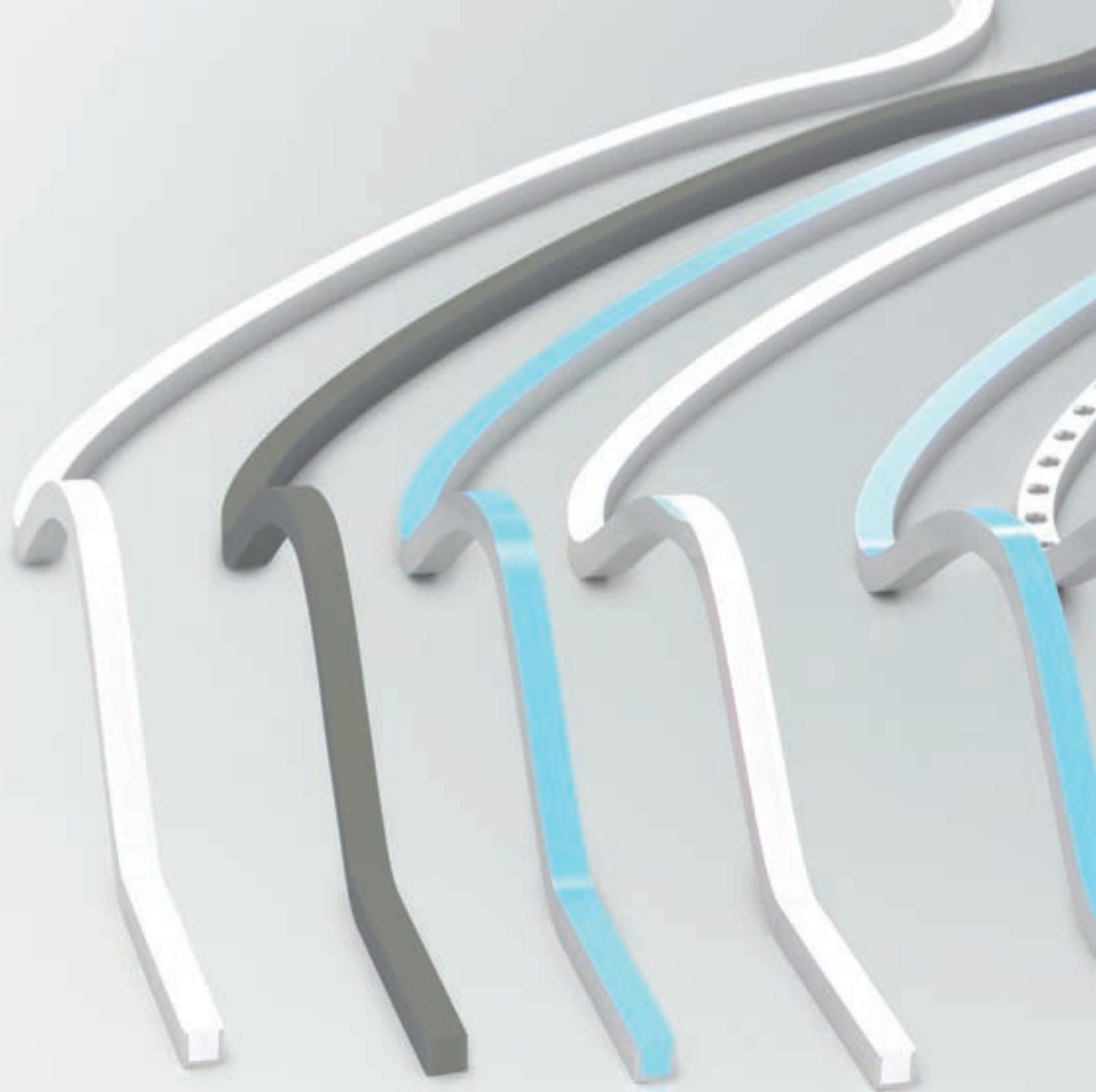

Rubber 3D
White finish

Rubber 3D
Concrete
finish

Rubber 3D
White finish
RGBW

**Rubber 3D
PROtection**
White finish
(pag 878)



**Rubber 3D
PROtection**
White finish
RGBW

**Rubber 3D
Optics**
White finish

**Rubber 3D
Optics**
Black finish

**Rubber 2D
Mini**
White finish

Rubber 2D
White finish

Rubber 2D
White finish
48 V

3D

Rubber 3D est unique en son genre : grâce à la structure brevetée du circuit interne, le produit peut se plier sur tous les axes et permettre de nouvelles méthodes d'installation et concepts applicatifs. Il n'y a pas de limite à l'imagination : les structures curvilignes organiques et fluides, avec changements de direction imprévus, ne sont plus un problème en raison de la flexibilité sans contrainte de Rubber 3D. Les rouleaux peuvent être facilement découpés tous les 45 mm afin de garantir de nombreuses possibilités d'utilisation différentes. Les câbles d'entrées/ de sortie facilitent le raccordement en série de plusieurs appareils d'éclairage en maintenant une lumière uniforme et constante sur toute la longueur de l'installation sans interruption aux points de jonction.

Rayon minimal de courbure : 250 mm



IP68 et immersion permanente

Pag. 878

Rubber 3D PROtection détient la certification de classe IP68, et se prête à des installations permanentes allant jusqu'à 3 mètres d'immersion, telles que dans les piscines, les fontaines, les cascades verticales, les douches modernes et bien d'autres encore, en garantissant un maximum de flexibilité. De plus, le câble d'alimentation étanche permet une protection contre l'eau. Longueur de 5 mètres, bien plus que la moyenne si l'on tient compte des produits similaires en vente sur le marché, le câble permet de placer un alimentateur dans un logement séparé pour aider l'installateur, et faciliter l'entretien ultérieur de Rubber, et/ou les éventuels remplacements.



IP68



Cove Light

Produit installé: Rubber 3D Optic
White Finish | Optic 20°
Distance d'installation: 10cm
Longueur du mur: 32,5m

Eclairage des passerelles:
250lux med

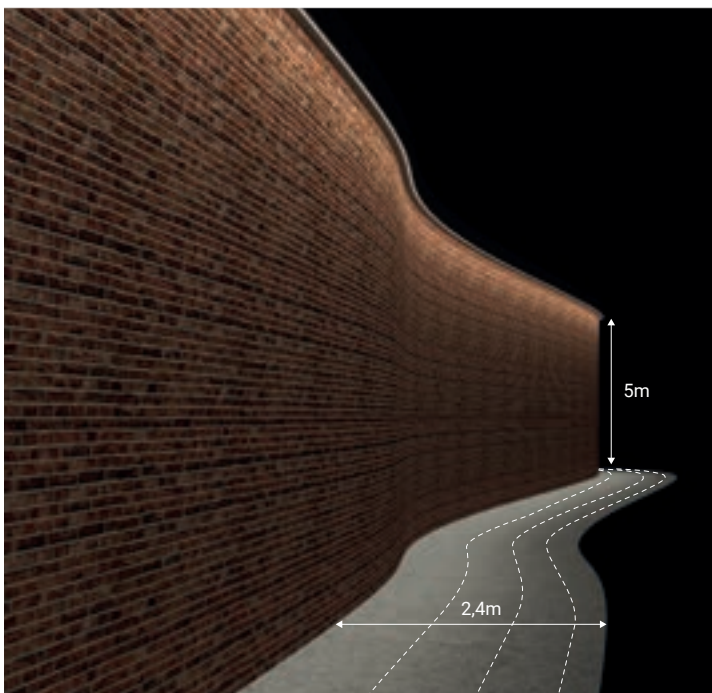

2D

Rubber 2D et le nouveau Rubber 2D Mini complètent la famille Rubber, en élargissant les possibilités de choix de la gamme. Rubber 2D est extrêmement flexible et peut se plier au point de couvrir un rayon très étroit. Il s'adapte parfaitement aux profilés sinueux et parcourant courbes et contrecourbes. Rubber 2D est disponible jusqu'à 10 mètres de longueur par rouleau, et peut être sectionné tous les 50 mm pour des compositions d'une grande ductilité. L'IP67 permet de réaliser une grande variété d'installation en extérieur. Grâce au raccordement avec des câbles d'entrée et de sortie, la lumière est uniforme et constante sur toute la longueur, et également aux points de jonction.

Rayon minimal de courbure : 250 mm



La caractéristique principale que Linea Light Group introduit avec Rubber 2D 48 V est la capacité d'augmenter la distance entre les points d'alimentation, utile également dans des projets pour lesquels les longueurs sont importantes. Simplifiant ainsi la conception et l'installation.



Rubber 2D Mini

Comme le modèle standard de 14 mm, la version Mini se propose comme une solution idéale pour les courbes et les contrecourbes qui demandent le pliage sur un axe unique, en combinant flexibilité d'installation et hautes performances. Certifié IP67, il se différencie des autres Rubber en raison de ses dimensions extrêmement réduites. En 6 mm à peine, Rubber 2D Mini concentre un circuit spécifiquement conçu pour obtenir de très hautes performances dans un éclairage très subtil, pour des effets linéaires discrets et élégants. Tout comme la partie électronique interne, les accessoires, les clips et les profilés ont été spécialement étudiés pour restituer un encombrement minimal à la Rubber 2D Mini.

Rayon de courbure minimum : 150 mm



Rubber 2D_mini | LED strip | 5 W/m 24 V DC

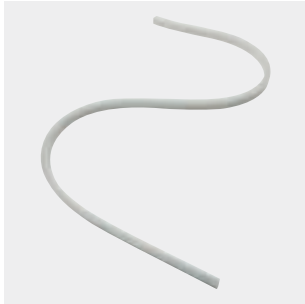

CRI 85	Cct	lm S - D
White 82147	2700	510 - 228
White 82148	3000	550 - 246
White 82149	4000	595 - 266

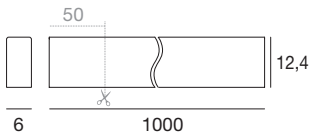

99374	99331	99332	83062	99787
ON/OFF 75 W p 210 x l 48 x h 25	ON/OFF 150 W p 150 x l 60 x h 35	0/1-10V 150 W p 150 x l 60 x h 35	DALI 120 W p 191 x l 63 x h 38	DALI 120 W p 244 x l 71 x h 38

CRI 85	Cct	lm S - D
White 82150	2700	2550 - 1140
White 82151	3000	2750 - 1230
White 82152	4000	2975 - 1330

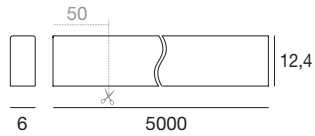

99374	99331	99332	83062	99787
ON/OFF 75 W p 210 x l 48 x h 25	ON/OFF 150 W p 150 x l 60 x h 35	0/1-10V 150 W p 150 x l 60 x h 35	DALI 120 W p 191 x l 63 x h 38	DALI 120 W p 244 x l 71 x h 38

CRI 85	Cct	lm S - D
White 82153	2700	5100 - 2280
White 82154	3000	5500 - 2460
White 82155	4000	5950 - 2660

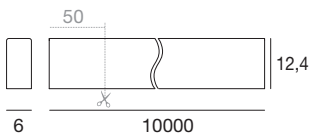

99374	99331	99332	83062	99787
ON/OFF 75 W p 210 x l 48 x h 25	ON/OFF 150 W p 150 x l 60 x h 35	0/1-10V 150 W p 150 x l 60 x h 35	DALI 120 W p 191 x l 63 x h 38	DALI 120 W p 244 x l 71 x h 38

RTG 82147 / 82148 / 82149 / 82150 / 82151
82152 / 82153 / 82154 / 82155

Accessoires et câbles Pag. 894/895

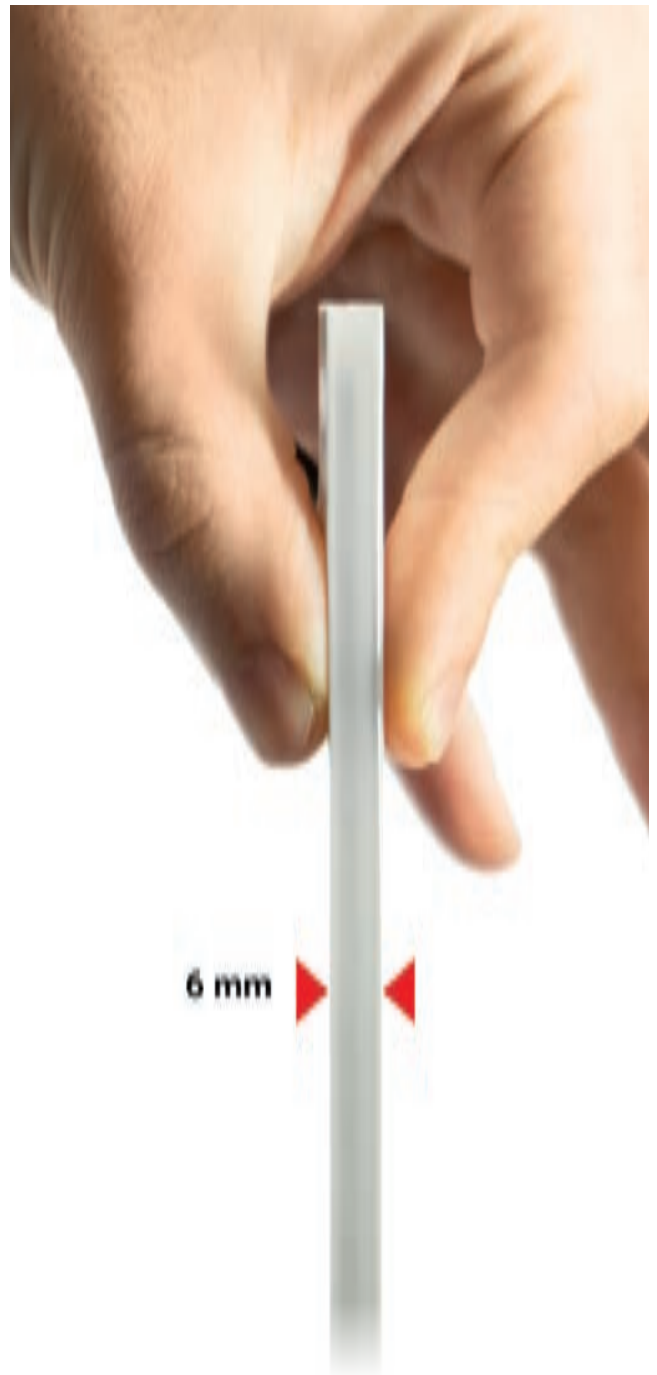

Rubber 2D | LED strip | 10 W/m 24 V DC



CRI 85	Cct	lm S - D
White 80409	2700	1060 - 437
White 80410	3000	1145 - 472
White 80411	4000	1236 - 509

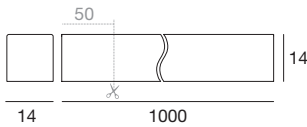

99374	99331	99332	83062	99787
ON/OFF 75 W p 210 x l 148 x h 25	ON/OFF 150 W p 150 x l 60 x h 35	0/1-10V 150 W p 150 x l 60 x h 35	DALI 120 W p 191 x l 63 x h 38	DALI 120 W p 244 x l 71 x h 38

CRI 85	Cct	lm S - D
White 80412	2700	5300 - 2185
White 80413	3000	5725 - 2360
White 80414	4000	6180 - 2545

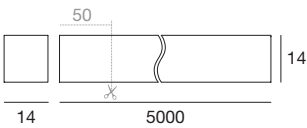

99374	99331	99332	83062	99787
ON/OFF 75 W p 210 x l 148 x h 25	ON/OFF 150 W p 150 x l 60 x h 35	0/1-10V 150 W p 150 x l 60 x h 35	DALI 120 W p 191 x l 63 x h 38	DALI 120 W p 244 x l 71 x h 38

CRI 85	Cct	lm S - D
White 80391	2700	10600 - 4370
White 80392	3000	11450 - 4720
White 80393	4000	12360 - 5090

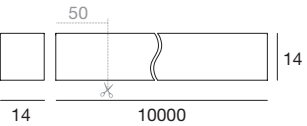

99374	99331	99332	83062	99787
ON/OFF 75 W p 210 x l 148 x h 25	ON/OFF 150 W p 150 x l 60 x h 35	0/1-10V 150 W p 150 x l 60 x h 35	DALI 120 W p 191 x l 63 x h 38	DALI 120 W p 244 x l 71 x h 38

RTG 80409 / 80410 / 80411 / 80412 / 80413 / 80414 / 80391 / 80392 / 80393

Accessoires et câbles Pag. 894/895

Rubber 2D | LED strip | 10 W/m 48 V DC



CRI 85	Cct	lm S - D
White 82135	2700	1060 - On req.
White 82136	3000	1145 - On req.
White 82137	4000	1236 - On req.

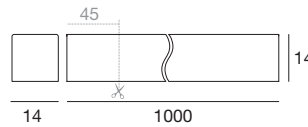

99784	99785	83179	Switching	83178
On/Off 150W CV 48V	On/Off 240W CV 48V	DALI/PUSH 150W CV 48V	Switching CV 48V Pag. 932	DMX 384W

CRI 85	Cct	lm S - D
White 82138	2700	5300 - On req.
White 82139	3000	5725 - On req.
White 82140	4000	6180 - On req.

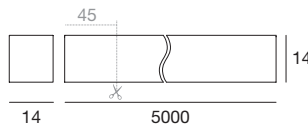

99784	99785	83179	Switching	83178
On/Off 150W CV 48V	On/Off 240W CV 48V	DALI/PUSH 150W CV 48V	Switching CV 48V Pag. 932	DMX 384W

CRI 85	Cct	lm S - D
White 82141	2700	10600 - On req.
White 82142	3000	11450 - On req.
White 82143	4000	12360 - On req.

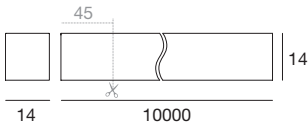

99784	99785	83179	Switching	83178
On/Off 150W CV 48V	On/Off 240W CV 48V	DALI/PUSH 150W CV 48V	Switching CV 48V Pag. 932	DMX 384W

RTG 82135 / 82136 / 82137 / 82138 / 82139 / 82140 / 82141 / 82142 / 82143

48V La caractéristique principale que Linea Light Group introduit avec Rubber 2D 48 V est la capacité d'augmenter la distance entre les points d'alimentation, utile également dans des projets pour lesquels les longueurs sont importantes. Simplifiant ainsi la conception et l'installation.

Accessoires et câbles Pag. 894/895

Rubber 3D | LED strip | 10W/m 24 V DC



CRI 85	Cct	lm S - D
White 80394	2700	1020 - 455
White 80395	3000	1100 - 506
Concrete 82208	3000	1100 - 260
White 80396	4000	1190 - 674

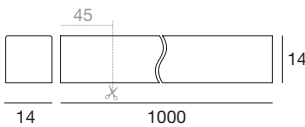

99374	99331	99332	83062	99787
ON/OFF 75 W p 210 x l 148 x h 25	ON/OFF 150 W p 150 x l 60 x h 35	0/1-10V 150 W p 150 x l 60 x h 35	DALI 120 W p 191 x l 63 x h 38	DALI 120 W p 244 x l 71 x h 38

CRI 85	Cct	lm S - D
White 80397	2700	5100 - 2275
White 80398	3000	5500 - 2528
Concrete 82211	3000	5500 - 1300
White 80399	4000	5950 - 3370

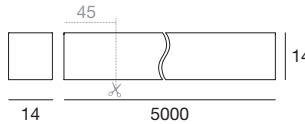

99374	99331	99332	83062	99787
ON/OFF 75 W p 210 x l 148 x h 25	ON/OFF 150 W p 150 x l 60 x h 35	0/1-10V 150 W p 150 x l 60 x h 35	DALI 120 W p 191 x l 63 x h 38	DALI 120 W p 244 x l 71 x h 38

CRI 85	Cct	lm S - D
White 80400	2700	10200 - 4550
White 80401	3000	11000 - 4910
White 80402	4000	11900 - 4300

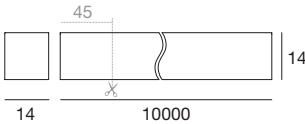

99374	99331	99332	83062	99787
ON/OFF 75 W p 210 x l 148 x h 25	ON/OFF 150 W p 150 x l 60 x h 35	0/1-10V 150 W p 150 x l 60 x h 35	DALI 120 W p 191 x l 63 x h 38	DALI 120 W p 244 x l 71 x h 38

RTG 80394 / 80395 / 80396 / 80397 / 80398 / 80399 / 80400 / 80401 / 80402 / 82208 / 82211

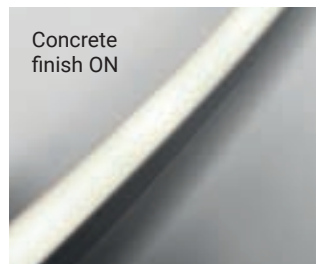
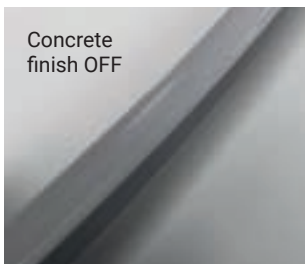

Rubber 3D RGBW | LED strip | 16,5 W/m 24 V DC



White 80403	RGBW (3000K) (CRI 85)	1 m
--------------------	-----------------------	-----

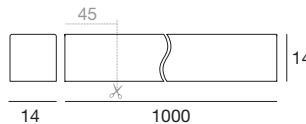

99696+ 99702	99331	99278	DMX	99331
Dimmer RF CV 24V 150 W p 150 x l 60 x h 35	Dimmer DMX CV 24V 150 W p 150 x l 60 x h 35	DMX Controllers Pag. 952 - 953	DMX Controllers Pag. 952 - 953	CV 24V 150 W p 150 x l 60 x h 35

White 80404	RGBW (3000K) (CRI 85)	5 m
--------------------	-----------------------	-----

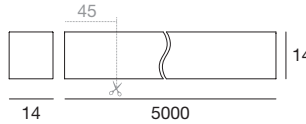

99696+ 99702	99331	99278	DMX	99331
Dimmer RF CV 24V 150 W p 150 x l 60 x h 35	Dimmer DMX CV 24V 150 W p 150 x l 60 x h 35	DMX Controllers Pag. 952 - 953	DMX Controllers Pag. 952 - 953	CV 24V 150 W p 150 x l 60 x h 35

RTG 80403 / 80404

Accessoires et câbles Pag. 894/895

Rubber 3D optics | LED strip | 24 V DC

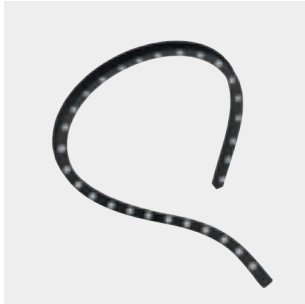

CRI 85 - 19 W - 1 m	Cct	lm S - D	Optic
White 82216	M 2700	2185 - 1748	20 Flood -
Black 82219	W 3000	2300 - 1840	30 Flood -
	N 4000	2415 - 1932	

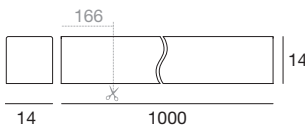

99374	99331	99332	83062	99787
ON/OFF 75 W p 210 x l 148 x h 25	ON/OFF 150 W p 150 x l 60 x h 35	0/1-10V 150 W p 150 x l 60 x h 35	DALI 120 W p 191 x l 63 x h 38	DALI 120 W p 244 x l 71 x h 38

CRI 85 - 28,5 W - 1,5 m	Cct	lm S - D	Optic
White 82217	M 2700	3277 - 2622	20 Flood -
Black 82220	W 3000	3450 - 2760	30 Flood -
	N 4000	3622 - 2898	

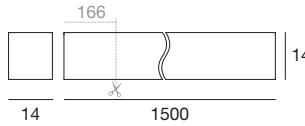

99374	99331	99332	83062	99787
ON/OFF 75 W p 210 x l 148 x h 25	ON/OFF 150 W p 150 x l 60 x h 35	0/1-10V 150 W p 150 x l 60 x h 35	DALI 120 W p 191 x l 63 x h 38	DALI 120 W p 244 x l 71 x h 38

CRI 85 - 57 W - 3 m	Cct	lm S - D	Optic
White 82218	M 2700	6554 - 5244	20 Flood -
Black 82221	W 3000	6900 - 5520	30 Flood -
	N 4000	7244 - 5796	

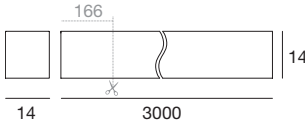

99374	99331	99332	83062	99787
ON/OFF 75 W p 210 x l 148 x h 25	ON/OFF 150 W p 150 x l 60 x h 35	0/1-10V 150 W p 150 x l 60 x h 35	DALI 120 W p 191 x l 63 x h 38	DALI 120 W p 244 x l 71 x h 38

RTG 82216W20 / 82216W30 / 82216N20 / 82216N30 / 82217W20 / 82217W30 / 82217N20 / 82217N30 / 82218W20 / 82218W30 / 82218N20 / 82218N30 / 82219M20 / 82219M30 / 82219W20 / 82219W30 / 82219N20 / 82219N30 / 82220M20 / 82220M30 / 82220W20 / 82220W30 / 82220N20 / 82220N30 / 82221M20 / 82221M30 / 82221W20 / 82221W30 / 82221N20 / 82221N30

Accessoires et câbles Pag. 894/895

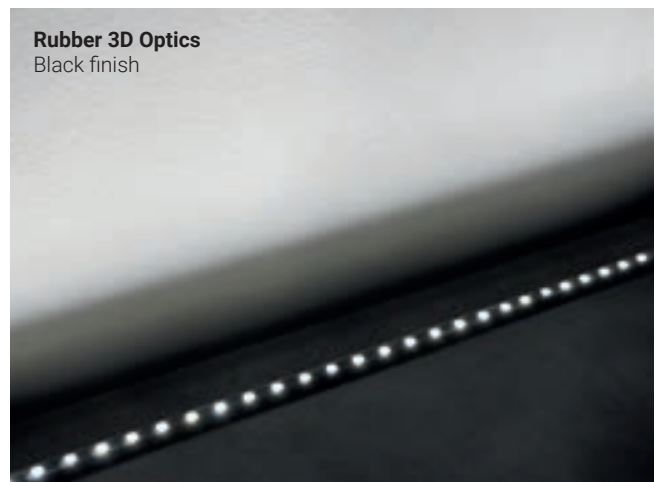

Accessoires

Rubber | Profil linéaire

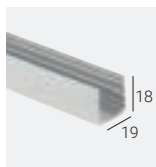

description		Anod. AL
99549	1000 mm/ 18 mm/ 19 mm	
suitable for: Rubber 2D / Rubber 3D		

Rubber | Profil linéaire

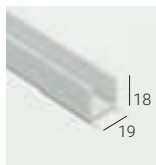

description		PVC
80418	1000 mm/ 18 mm/ 19 mm	
suitable for: Rubber 2D / Rubber 3D		

Rubber | Profil linéaire avec passage de câble

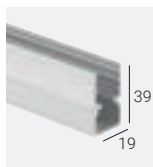

description		Anod. AL
83034	1000 mm/ 39 mm/ 19 mm	
suitable for: Rubber 2D / Rubber 3D		

Rubber | Profil linéaire avec passage de câble

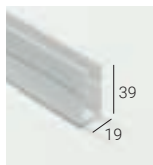

description		PVC
80419	1000 mm/ 39 mm/ 19 mm	
suitable for: Rubber 2D / Rubber 3D		

Rubber | Profil linéaire

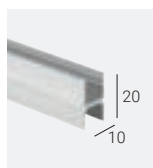

description		Anod. AL
82846	1000 mm/ 20 mm/ 10 mm	
suitable for: Rubber 2D Mini		

RTG 99549 / 80418 / 83034 / 80419 / 82846

Rubber | Profil flexible



description		Steel
99541	1045 mm/ 19 mm/ 16,2 mm	
suitable for: Rubber 2D / Rubber 3D		

RTG 99541

Rubber | Clip avec ressort denté



description		Anod. AL
99536	50 mm/ 23 mm/ 21 mm	
suitable for: Rubber 2D / Rubber 3D		

Rubber | Clip



description		PVC
80733	50 mm/ 18 mm/ 19 mm	
suitable for: Rubber 2D / Rubber 3D		

Rubber | Clip avec ressort denté avec passage de câble



description		Anod. AL
99537	50 mm/ 41 mm/ 21 mm	
suitable for: Rubber 2D / Rubber 3D		

Rubber | Clip avec passage de câble

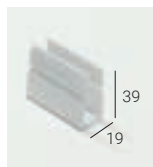

description		PVC
80734	50 mm/ 39 mm/ 19 mm	
suitable for: Rubber 2D / Rubber 3D		

Rubber | Clip avec ressort denté



description		Anod. AL
82847	50 mm/ 20 mm/ 10 mm	
suitable for: Rubber 2D Mini		

RTG 99536 / 80733 / 99537 / 80734 / 82847

Accessoires

Rubber | Kit de bouchons



description	
99539	
suitable for: Rubber 2D / Rubber 3D	

Rubber | Gabarit pour béton Rubber

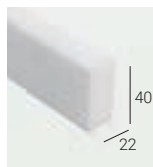

description	
99521	1100 mm/ 40 mm/ 22 mm
suitable for: Rubber 2D / Rubber 3D	

Rubber | Kit de bouchons



description	
99538	
suitable for: Rubber 2D Mini	

RTG 99539 / 99521 / 99538

Câbles

Rubber | Câble avec connecteur femelle



description	
99688	2x 0,75 / 2000 mm
suitable for: Rubber 2D / Rubber 3D	

Rubber | Câble avec connecteur mâle



description	
99689	2x 0,75 / 2000 mm
suitable for: Rubber 2D / Rubber 3D	

Rubber | Câble avec connecteur femelle RGBW



description	
99692	5x 0,75 / 2000 mm
suitable for: Rubber 3D RGBW	

Rubber | Câble avec connecteur mâle RGBW



description	
99693	5x 0,75 / 2000 mm
suitable for: Rubber 3D RGBW	

RTG 99688 / 99689 / 99692 / 99693

Accessoires IP68

Rubber | Boîtier d'encastrement



description	
98148	
suitable for: Rubber 2D / Rubber 3D	

Rubber | Ruban adhésif double face



description	
99520	33 m
suitable for: Rubber 3D	

Rubber | Connecteur

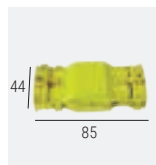

description	
89548	
suitable for: Rubber 3D	

Rubber | Connecteur



description	
98990	
suitable for: Rubber 3D	

RTG 98148 / 99520 / 89548

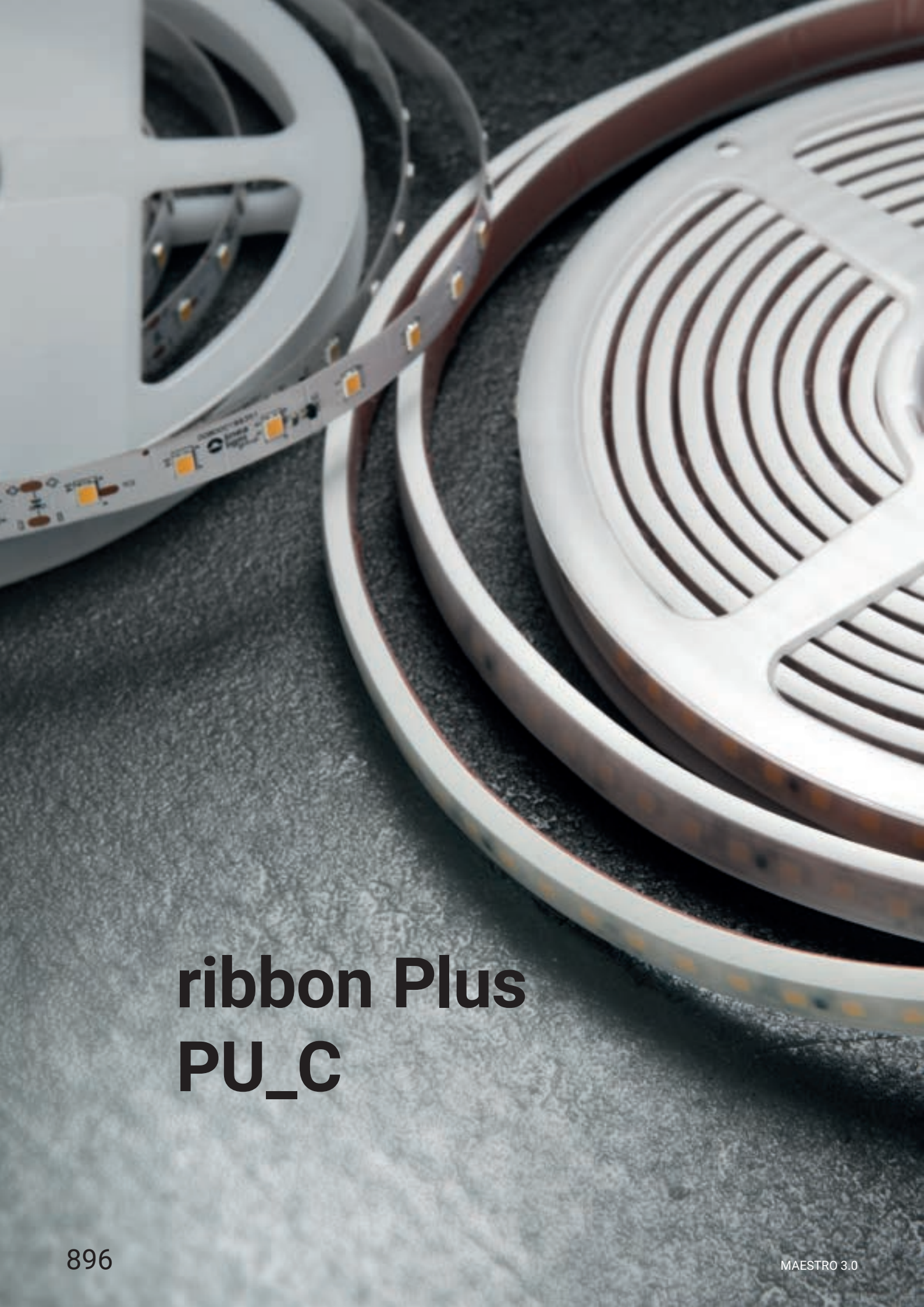

ribbon Plus PU_C



QUALITÉ, MATÉRIAUX, SÉCURITÉ, TEST ET CONTROL PARLENT UNE SEULE LANGUE



Qualité

Rubber et Strip, sont certifiés et ont une garantie de 3 ans, extensible jusqu'à 5 ans sur demande. Les différents types, températures de couleur et puissances sont immédiatement disponibles, et ce, grâce à une chaîne d'approvisionnement courte et contrôlée, 100 % Made in Italy. La société est certifiée ISO 9001. Les matériaux et composants utilisés pour la fabrication de nos produits sont garantis par des organismes internationaux de certification, tels qu'IMQ et UL, et sont marqués et testés selon les normes CE.



Matériel

Tous matériaux employés dans la fabrication de Rubber et Strip sont de la plus haute qualité. Rubber possède une structure en polyuréthane stabilisé et un diffuseur en résine de polyuréthane, ce qui garantit un maximum de flexibilité et de polyvalence grâce à la qualité des matières premières utilisées. Strip LED est recouvert de polyuréthane, un matériau capable de résister à des contraintes et des températures élevées. En outre, ces produits sont, en outre, conçus pour résister au vieillissement et au jaunissement à long terme. Le cuivre utilisé dans les circuits présente un degré de pureté de 99,9 %, garantissant ainsi la continuité parfaite des connexions électroniques. Auto-dissipante par nature, la gamme Flex Light ne nécessite pas de corps dissipateur ni de systèmes de dissipation supplémentaires.



Autodissipation

Rubber est composé de différents matériaux: la structure est en polyuréthane et le diffuseur en résine de polyuréthane. Strip possède un revêtement en silicone. S'agissant de matériaux plastiques, ils sont sujets à des variations chromatiques et physiques au fil du temps. Linea Light Group a choisi des matériaux qui préviennent ces effets indésirables. Le test aux rayons UV vise à prévenir le vieillissement des produits, en simulant des conditions extrêmes (jusqu'à 80 °C) et des chocs thermiques, pour garantir les matériaux et leurs performances dans le temps.

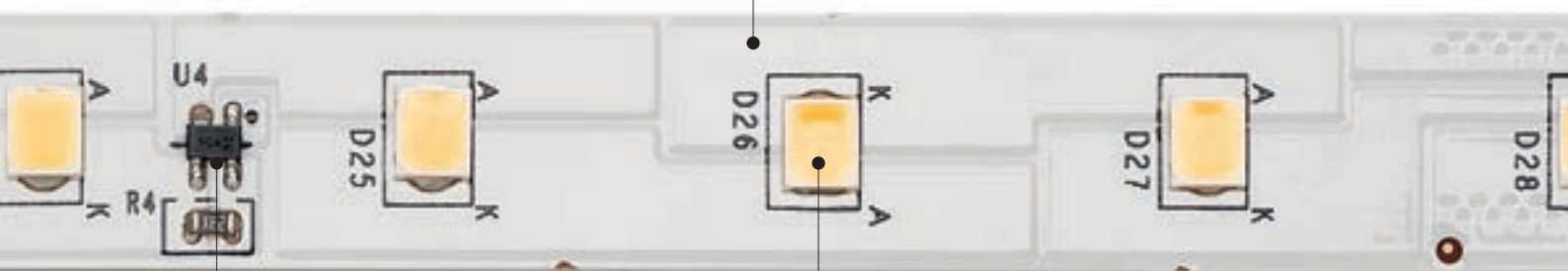
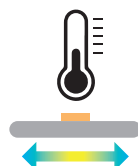

Intégrés régulateurs

Tous les produits de la gamme Flex Light sont dotés d'un système à polarité inversée qui sert de garantie et de protection en cas d'inversion des pôles lors du montage. En outre, la présence de circuits régulateurs intégrés garantit l'uniformité et l'homogénéité de la lumière sur toute la longueur de l'installation.

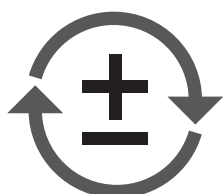

Test e control

Rubber et Strip LED ont été conçus et fabriqués pour assurer le meilleur confort visuel possible. L'ensemble de la gamme est étudié pour s'adapter au rythme circadien, simplement en ajustant l'intensité lumineuse et la température de couleur de manière progressive de 3000 K à 6000 K. Ceci favorise le contrôle de la mélatonine et la fixation du cortisol, deux éléments essentiels au bien-être visuel et vital de l'homme. En outre, les nombreux tests garantissent la durabilité et le maintien de l'efficacité et de la qualité de la lumière, éléments fondamentaux dans les environnements fermés ou protégés, tels que les bureaux ou les hôpitaux.



Ribbon Plus 70 LEDs/m | LED strip | 3,2 W/m 24 V DC

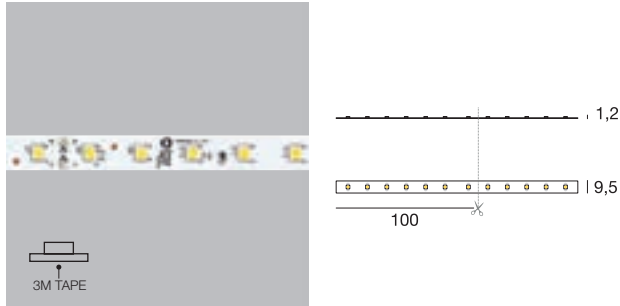

CRI 85 - 5 m 16W	Cct	lm S - D
98635	2700	2070 - 1970
98636	3000	2245 - 2140
98637	4000	2425 - 2309

99374	99331	99332	83062	99787
ON/OFF 75 W p 210 x l 48 x h 25	ON/OFF 150 W p 150 x l 60 x h 35	0/1-10V 150 W p 150 x l 60 x h 35	DALI 120 W p 191 x l 63 x h 38	DALI 120 W p 244 x l 71 x h 38

RTG 98635 / 98636 / 98637

Ribbon Plus 140 LEDs/m | LED strip | 7,2 W/m 24 V DC

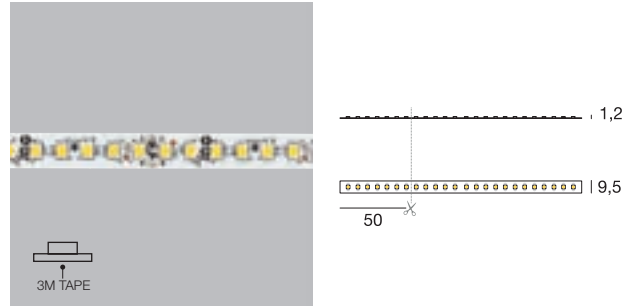

CRI 85 - 5 m 36W	Cct	lm S - D
98945	2700	4315 - 4115
98946	3000	4615 - 4400
98948	4000	4715 - 4490

99374	99331	99332	83062	99787
ON/OFF 75 W p 210 x l 48 x h 25	ON/OFF 150 W p 150 x l 60 x h 35	0/1-10V 150 W p 150 x l 60 x h 35	DALI 120 W p 191 x l 63 x h 38	DALI 120 W p 244 x l 71 x h 38

RTG 98945 / 98946 / 98948

Ribbon Plus Hi-Flux 70 LEDs/m | LED strip | 12,6 W/m 24 V DC

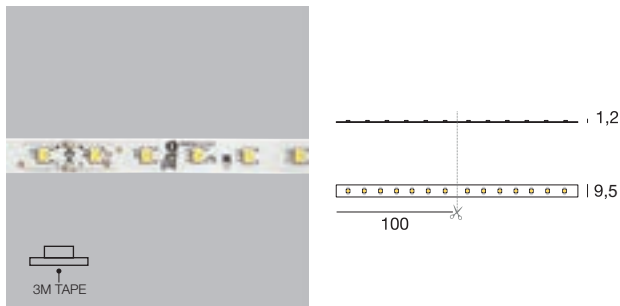

CRI 85 - 5 m 63W	Cct	lm S - D
98638	2700	7745 - 7375
98639	3000	8385 - 7975
98640	4000	8980 - 8550

99374	99331	99332	83062	99787
ON/OFF 75 W p 210 x l 48 x h 25	ON/OFF 150 W p 150 x l 60 x h 35	0/1-10V 150 W p 150 x l 60 x h 35	DALI 120 W p 191 x l 63 x h 38	DALI 120 W p 244 x l 71 x h 38

RTG 98638 / 98639 / 98640

Ribbon Plus 140 Hi-Flux LEDs/m | LED strip | 25 W/m 24 V DC

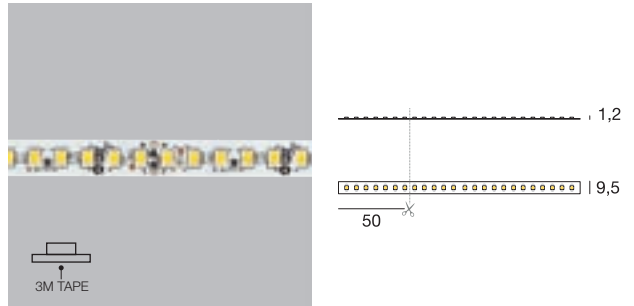

CRI 85 - 5 m 125W	Cct	lm S - D
81956	2700	2416 - 2300
81957	3000	2531 - 2410
81958	4000	2626 - 2500

99374	99331	99332	83062	99787
ON/OFF 75 W p 210 x l 48 x h 25	ON/OFF 150 W p 150 x l 60 x h 35	0/1-10V 150 W p 150 x l 60 x h 35	DALI 120 W p 191 x l 63 x h 38	DALI 120 W p 244 x l 71 x h 38

RTG 81956 / 81957 / 81958

Ribbon Plus WT 70+70 LEDs/m | LED strip | 13 W/m 24 V DC

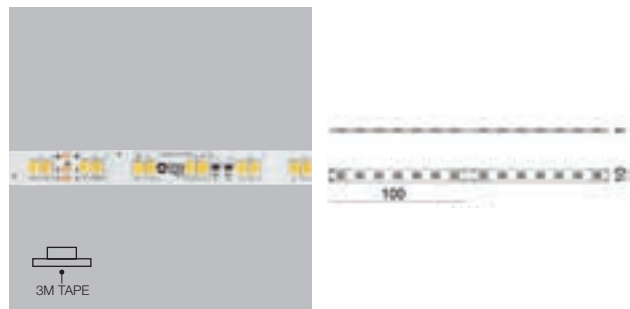

CRI 85 - 5 m 65W
99671 1800-3000 K

99694 + 99700	99331	99278	DMX	99331
Dimmer RF	CV 24V 150 W p 150 x l 60 x h 35	Dimmer DMX	DMX Controllers Pag. 952 - 953	CV 24V 150 W p 150 x l 60 x h 35

RTG 99671

Ribbon Plus Dynamic White 70+70 LEDs/m | LED strip | 12,8 W/m 24 V DC



CRI 85 - 5 m 64W
99672 1800-5000 K

99695 + 99701	99331	99278	DMX	99331
Dimmer RF	CV 24V 150 W p 150 x l 60 x h 35	Dimmer DMX	DMX Controllers Pag. 952 - 953	CV 24V 150 W p 150 x l 60 x h 35

RTG 99672

Ribbon Plus RGBW | LED strip 60+60 LEDs/m | 19,6 W/m 24 V DC



5 m 98W
99670 RBGW - 3000 K (CRI 85)

99696 + 99702	99331	99278	DMX	99331
Dimmer RF	CV 24V 150 W p 150 x l 60 x h 35	Dimmer DMX	DMX Controllers Pag. 952 - 953	CV 24V 150 W p 150 x l 60 x h 35

RTG 99670

PU_C Plus 70 LEDs/m | LED strip | 3,2 W/m 24 V DC

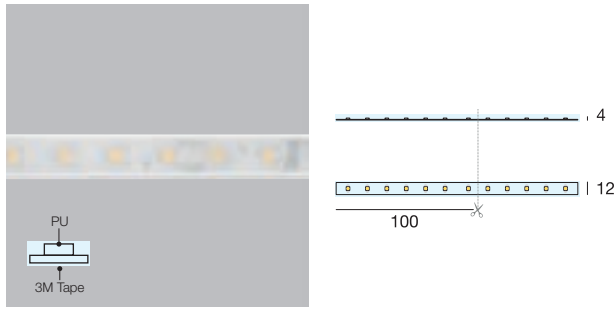

CRI 85 - 5 m 16W	Cct	lm S - D
98774	2700	2070 - 314
98776	3000	2245 - 350
98775	4000	2425 - 466

99374	99331	99332	83062	99787
ON/OFF 75 W	ON/OFF 150 W	0/1-10V 150 W	DALI 120 W	DALI 120 W
p 210 x 148 x h 25	p 150 x 160 x h 35	p 150 x 160 x h 35	p 191 x 163 x h 38	p 244 x 171 x h 38

RTG 98774 / 98776 / 98775

PU_C Plus 140 LEDs/m | LED strip | 7,2 W/m 24 V DC

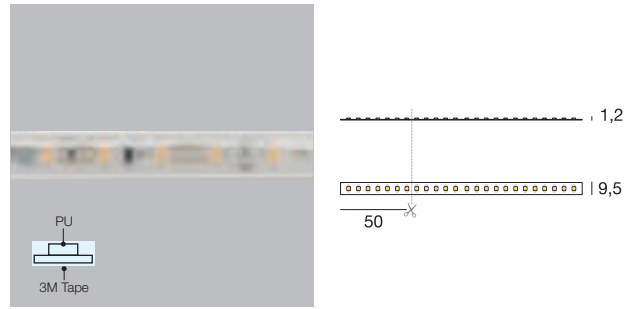

CRI 85 - 5 m 36W	Cct	lm S - D
81959	2700	897 - On req.
81960	3000	923 - 740
81961	4000	981 - On req.

99374	99331	99332	83062	99787
ON/OFF 75 W	ON/OFF 150 W	0/1-10V 150 W	DALI 120 W	DALI 120 W
p 210 x 148 x h 25	p 150 x 160 x h 35	p 150 x 160 x h 35	p 191 x 163 x h 38	p 244 x 171 x h 38

RTG 81959 / 81960 / 81961

PU_C Plus Hi-Flux 70 LEDs/m | LED strip | 12,6 W/m 24 V DC

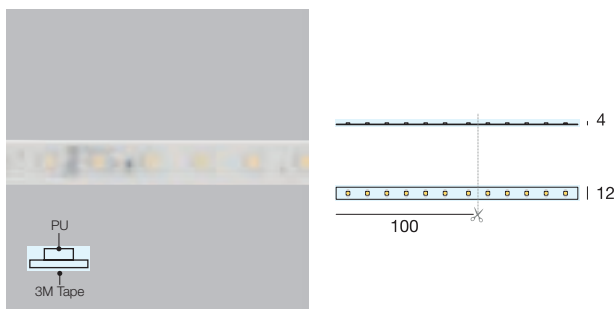

CRI 85 - 5 m 63W	Cct	lm S - D
98777	2700	7745 - 1340
98779	3000	8385 - 1361
98778	4000	8980 - 1401

99374	99331	99332	83062	99787
ON/OFF 75 W	ON/OFF 150 W	0/1-10V 150 W	DALI 120 W	DALI 120 W
p 210 x 148 x h 25	p 150 x 160 x h 35	p 150 x 160 x h 35	p 191 x 163 x h 38	p 244 x 171 x h 38

RTG 98777 / 98779 / 98778

PU_C Plus 140 Hi-Flux LEDs/m | LED strip | 25 W/m 24 V DC

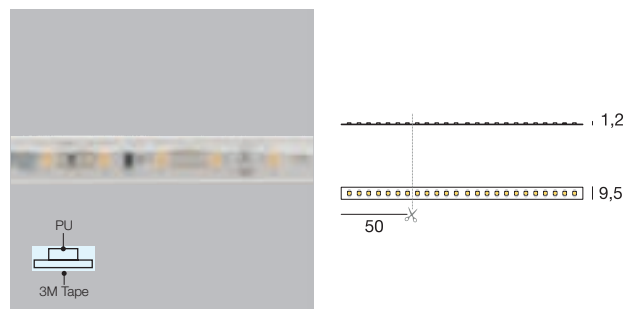

CRI 85 - 5 m 125W	Cct	lm S - D
81962	2700	2340 - On req.
81963	3000	2531 - 1910
81964	4000	2600 - On req.

99374	99331	99332	83062	99787
ON/OFF 75 W	ON/OFF 150 W	0/1-10V 150 W	DALI 120 W	DALI 120 W
p 210 x 148 x h 25	p 150 x 160 x h 35	p 150 x 160 x h 35	p 191 x 163 x h 38	p 244 x 171 x h 38

RTG 81962 / 81963 / 81964

PU_C RGBW 60 LEDs/m | LED strip | 19,6 W/m 24 V DC

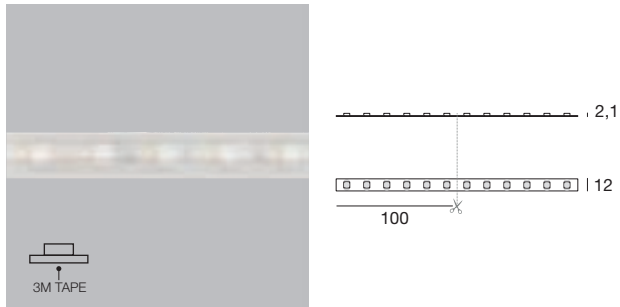

5 m 98W

81965 RGBW - 3000 K (CRI 85)

99696 + 99702	99331	99278	DMX	99331
Dimmer RF	CV 24V 150 W p 150 x l 60 x h 35	Dimmer DMX	DMX Controllers Pag. 952 - 953	CV 24V 150 W p 150 x l 60 x h 35

RTG 81965

PU_C Plus | Kit de fixation

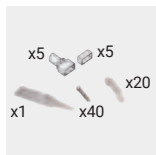

	description
98964	1 x glue 20 x brackets 40 x M3x25 screws 10 x caps

suitable for: 5 m PU_C

RTG 98964

PU_C Plus | Support de fixation



	description
89223	10 x brackets 20 x M3x25 screws

suitable for: 5 m PU_C

RTG 89223

ribbon dropper silicone_C





Ribbon Basic 60 LEDs/m | LED strip | 5 W/m 24 V DC

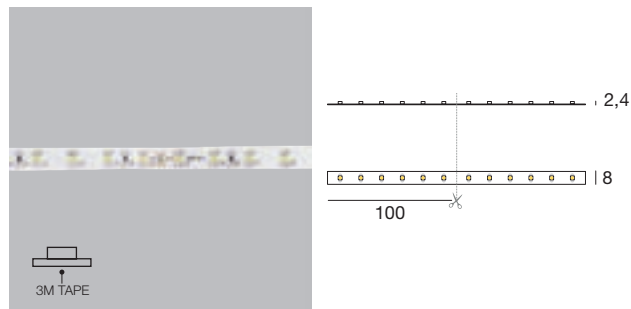

CRI 80 - 5 m 24W	Cct	lm S - D
98011	2700	1800 - 360
98556	3000	1825 - 365
98012	4000	1850 - 370

Ribbon 120 LEDs/m | LED strip | 9,6 W/m 24 V DC

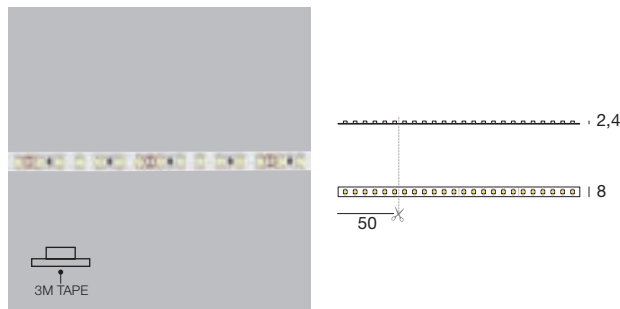

CRI 80 - 5 m 48W	Cct	lm S - D
83659	2700	4250 - 720
83657	3500	4400 - 725
83658	4000	4800 - 740

Ribbon Hi-Flux 60 LEDs/m | LED strip | 12 W/m 24 V DC

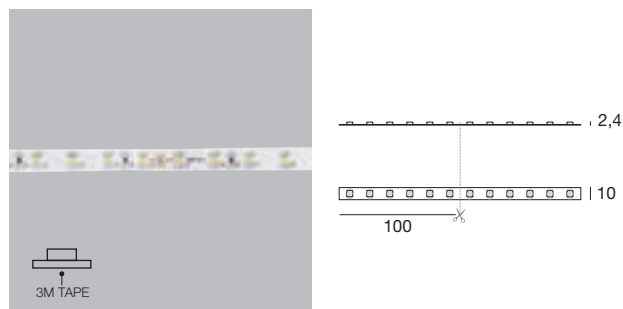

CRI 80 - 5 m 60W	Cct	lm S - D
99608	2700	4900 - On req.
99612	3000	5100 - On req.
99610	4000	5500 - On req.

Ribbon 240 LEDs/m | LED strip | 19,2 W/m 24 V DC

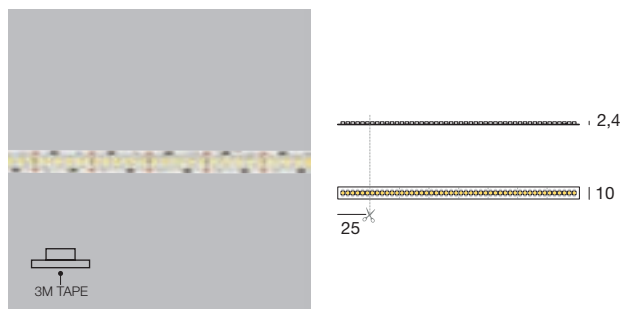

CRI 80 - 5 m 96W	Cct	lm S - D
98084	2700	7200 - 1440
98570	3000	7250 - 1440
98083	4000	7400 - 1480

Ribbon 120 LEDs/m | LED strip | 9,6 W/m 24 V DC

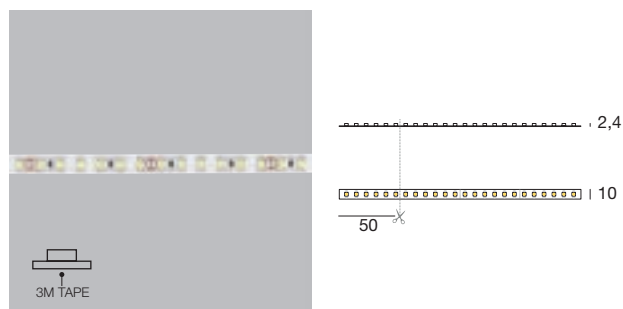

CRI 80 - 5 m 48W	Cct	lm S - D
98078	2700	3600 - 720
98568	3000	3610 - 720
98077	4000	3700 - 740

Ribbon Slim 120 LEDs/m | LED strip | 9,6 W/m 24 V DC

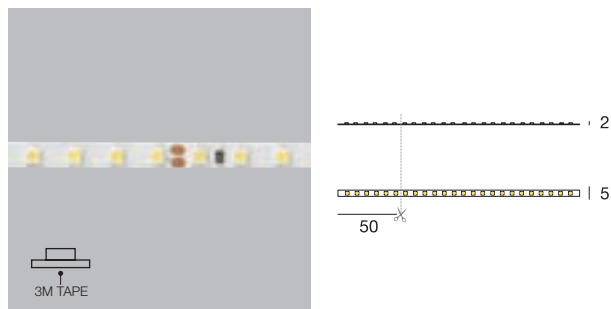

CRI 80 - 5 m 48W	Cct	lm S - D
98880	2700	3350 - On req.
98881	3000	3450 - On req.
98882	4000	3750 - On req.

Électronique

99374	99331	99332	83062	99787
ON/OFF	ON/OFF	0/1-10V	DALI	DALI
75 W	150 W	150 W	120 W	120 W
p 210 x 148 x h 25	p 150 x 160 x h 35	p 150 x 160 x h 35	p 191 x 163 x h 38	p 244 x 171 x h 38

Ribbon Hi-Flux 150 LEDs/m | LED strip | 20 W/m 48 V DC

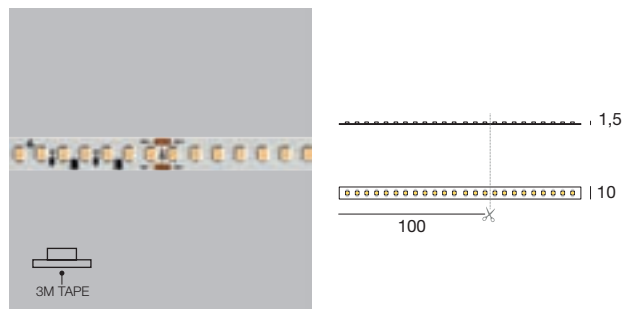

CRI 80 - 5 m 100W	Cct	lm S - D
84195	3000	8625 - 0n req.
84196	4000	9750 - 0n req.

99784	99785	83179	Switching	83178
On/Off 150W CV 48V	On/Off 240W CV 48V	DALI/PUSH 150W CV 48V	Switching CV 48V Pag. 932	DMX 384W

Ribbon RGB 60 LEDs/m | LED strip | 14,4 W/m 24 V DC

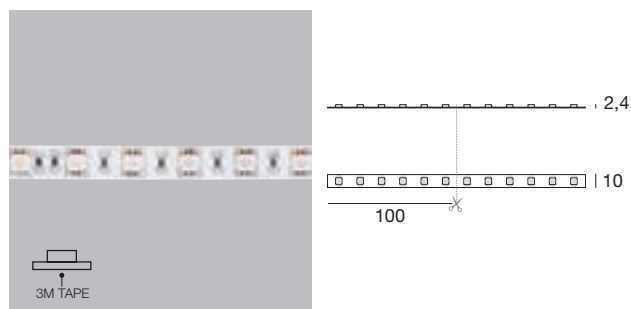

5 m 72W	98017	RGB
---------	-------	-----

99696+ 99702	99331	99278	DMX	99331
Dimmer RF	CV 24V 150 W p 150 x l 60 x h 35	Dimmer DMX	DMX Controllers Pag. 952 - 953	CV 24V 150 W p 150 x l 60 x h 35

Ribbon RGBW 60 LEDs/m | LED strip | 19,2 W/m 48 V DC

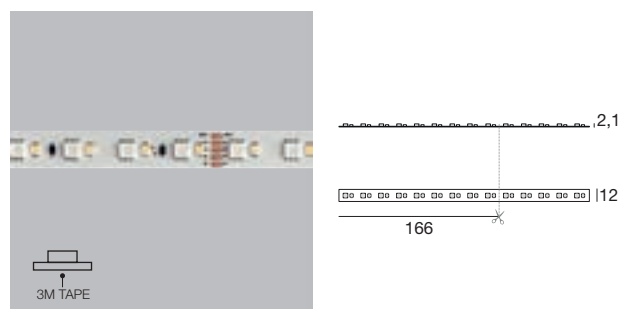

CRI 80 - 5 m 96W	84197	84198
	RGBW - 3000 K (CRI 80)	RGBW - 4000 K (CRI 80)

99696+ 99702	99331	99278	DMX	99331
Dimmer RF	CV 24V 150 W p 150 x l 60 x h 35	Dimmer DMX	DMX Controllers Pag. 952 - 953	CV 24V 150 W p 150 x l 60 x h 35

Ribbon Dynamic 60+60 LEDs/m | LED strip | 19,2 W/m 24 V DC

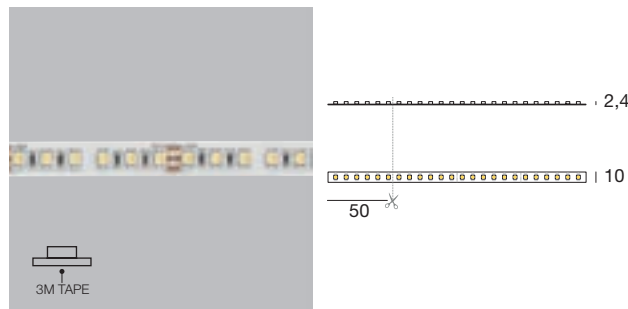

CRI 80 - 5 m 96W	98548
	3000 - 6000 K

99695+ 99701	99331	99278	DMX	99331
Dimmer RF	CV 24V 150 W p 150 x l 60 x h 35	Dimmer DMX	DMX Controllers Pag. 952 - 953	CV 24V 150 W p 150 x l 60 x h 35

Pag. 906

RTG 98011 / 98556 / 98012

RTG 83659 / 83657 / 83658

RTG 99608 / 99612 / 99610

RTG 98078 / 98568 / 98077

RTG 98084 / 98570 / 98083

RTG 98880 / 98881 / 98882

Pag. 907

RTG 84195 / 84196

RTG 98017

RTG 84197 / 84198

Dropper Basic 60 LEDs/m | LED strip | 5 W/m 24 V DC

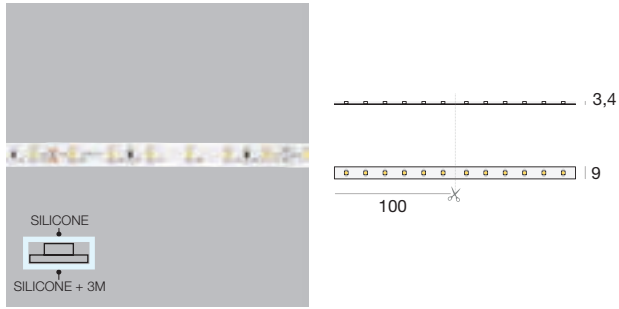

CRI 80 - 5 m 25W	Cct	lm S - D
99588	2700	2300 - On req.
99592	3000	2400 - On req.
99590	4000	2500 - On req.

★ Électronique **RTG 99588 / 99592 / 99590**

Dropper Hi-Flux 60 LEDs/m | LED strip | 14,4 W/m 24 V DC

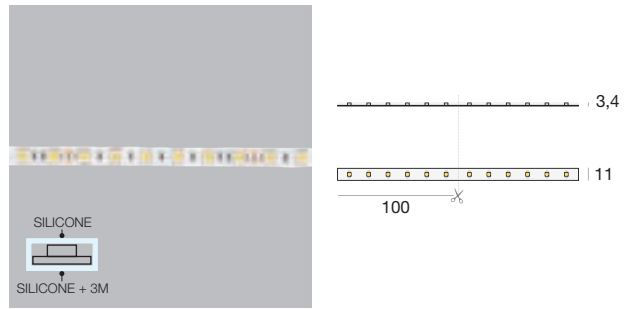

CRI 80 - 5 m 72W	Cct	lm S - D
99628	2700	4750 - On req.
99632	3000	5100 - On req.
99630	4000	5500 - On req.

★ Électronique **RTG 99628 / 99632 / 99630**

Dropper Hi-Flux 60 LEDs/m | LED strip | 14,4 W/m 24 V DC

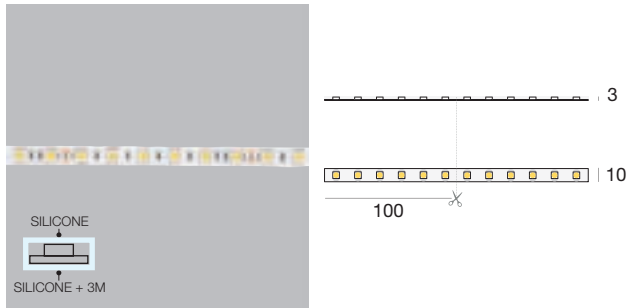

CRI 80 - 5 m 72W	Cct	lm S - D
98092	2700	5400 - 1080

★ Électronique **RTG 98092**

Dropper 120 LEDs/m | LED strip | 9,6 W/m 24 V DC

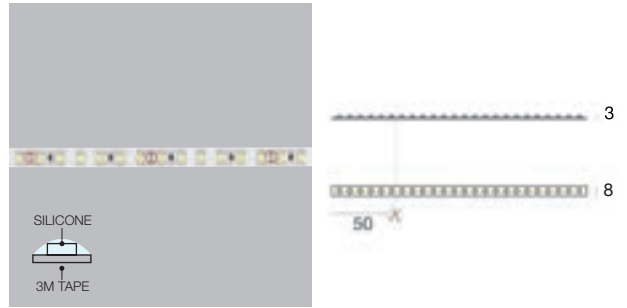

CRI 80 - 5 m 48W	Cct	lm S - D
98572	3000	3610 - 144
98574	4000	3700 - On req.

★ Électronique **RTG 98572 / 98574**

Dropper RGB 60 LEDs/m | LED strip | 14,4 W/m 24 V DC

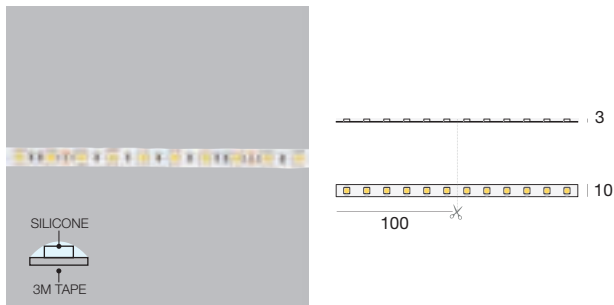

5 m 72W	
98025	RGB

★★ Électronique **RTG 98025**

★ 99374	99331	99332	83062	99787
ON/OFF 75 W p 210 x l 48 x h 25	ON/OFF 150 W p 150 x l 60 x h 35	0/1-10V 150 W p 150 x l 60 x h 35	DALI 120 W p 191 x l 63 x h 38	DALI 120 W p 244 x l 71 x h 38

★★ 99696+ 99702	99331	99278	DMX	99331
Dimmer RF	CV 24V 150 W p 150 x l 60 x h 35	Dimmer DMX	DMX Controllers Pag. 952 - 953	CV 24V 150 W p 150 x l 60 x h 35

Silicone_C Basic 60 LEDs/m | LED strip | 4,8 W/m 24 V DC

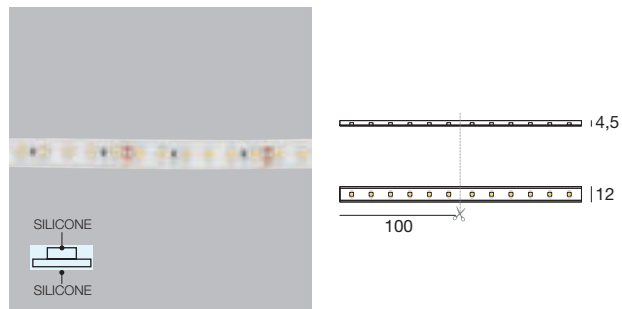

CRI 80 - 5 m 24W	Cct	lm S - D
99598	2700	1800 - On req.
99602	3000	2300 - On req.
99600	4000	1850 - On req.

★ **Électronique** **RTG** 99598 / 99602 / 99600

Silicone_C Hi-Flux 60 LEDs/m | LED strip | 12 W/m 24 V DC

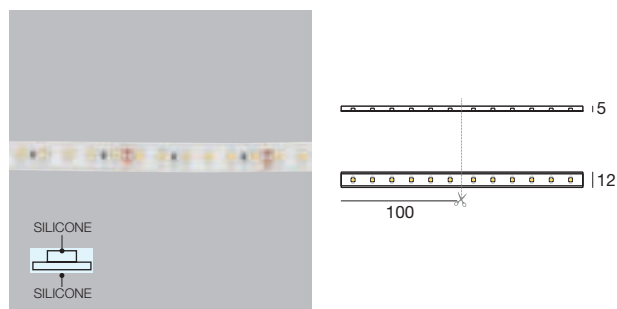

CRI 80 - 5 m 60W	Cct	lm S - D
99622	3000	4750 - On req.
99620	4000	5100 - On req.

★ **Électronique** **RTG** 99622 / 99620

Silicone_C Hi-Flux 60 LEDs/m | LED strip | 14,4 W/m 24 V DC

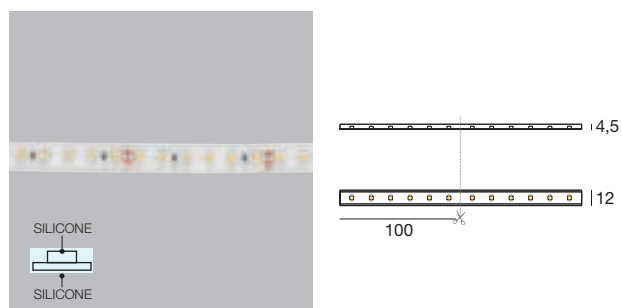

CRI 80 - 5 m 72W	Cct	lm S - D
98042	2700	5400 - On req.

★ **Électronique** **RTG** 98042

★ 99374	99331	99332	83062	99787
ON/OFF 75 W p 210 x l 48 x h 25	ON/OFF 150 W p 150 x l 60 x h 35	0/1-10V 150 W p 150 x l 60 x h 35	DALI 120 W p 191 x l 63 x h 38	DALI 120 W p 244 x l 71 x h 38

Silicone_C 120 LEDs/m | LED strip | 14,4 W/m 24 V DC

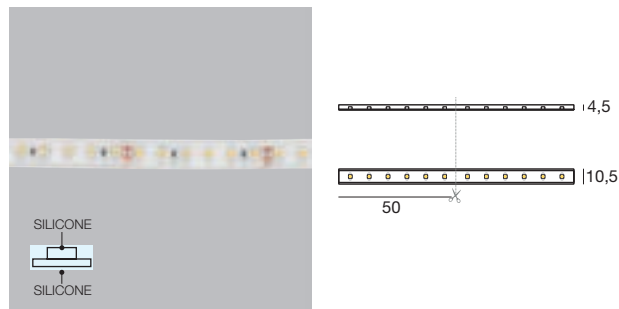

CRI 80 - 5 m 72W	Cct	lm S - D
62403	3000	7230 - On req.
62403N	4000	7495 - On req.

★ **Électronique** **RTG** 62403 / 62403N

Silicone_C Basic RGB 60 LEDs/m | LED strip | 14,4 W/m 24 V DC

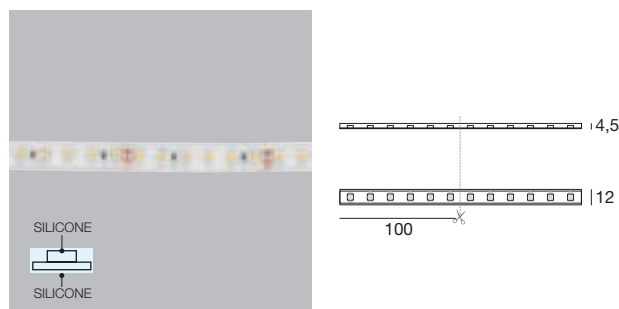

5 m 72W	
98033	RGB

★★ **Électronique** **RTG** 98033

Silicone_C | Kit de fixation

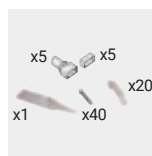

description
1 x glue
20 x brackets
40 x M3x25 screws
10 x caps

suitable for: 5 m Silicone_C

Silicone_C | Support de fixation



description
10 x brackets
20 x M3x25 screws

suitable for: 5 m Silicone_C

RTG 89223

★★ 99696 + 99702	99331	99278	DMX	99331
Dimmer RF	CV 24V 150 W p 150 x l 60 x h 35	Dimmer DMX	DMX Controllers Pag. 952 - 953	CV 24V 150 W p 150 x l 60 x h 35

LED Strips | Câble à prises multiples



RTG

	connector	L mm	sec. Ø	available for
89121	F	300	2 x 0,35 mm ²	Ribbon mono
				Dropper mono

LED Strips | Rallonge pour prises multiples



RTG

	connector	L mm	sec. Ø	available for
89123	M + F	1000	2 x 0,35 mm ²	Ribbon mono
89125	M + F	3000	2 x 0,35 mm ²	Dropper mono

LED Strips | Connecteur rapide



RTG

	connector	L mm	sec. Ø	available for
98384	1 clip	150	2 x 0,35 mm ²	Ribbon basic mono
				Ribbon Hi-Flux mono

LED Strips | Extension du connecteur rapide



RTG

	connector	L mm	sec. Ø	available for
98379	2 clip	150	2 x 0,70 mm ²	Ribbon basic mono
				Ribbon Hi-Flux mono

LED Strips | Joint de connecteur rapide



RTG

	connector	available for
98383	2 clip	Ribbon basic mono
		Ribbon Hi-Flux mono
		Ribbon basic RGB
		Ribbon Hi-Flux RGB

LED Strips | Câble à prises multiples



RTG

	connector	L mm	sec. Ø	available for
89119	6 M	1000	2 x 0,35 mm ²	Ribbon basic mono
				Dropper mono

LED Strips | Rallonge pour prises multiples



RTG

	connector	sec. Ø	available for
99357	F	3 x 0,35 mm ²	Ribbon Dynamic
99358	M	3 x 0,35 mm ²	Ribbon Dynamic

LED Strips | Rallonge pour prises multiples



RTG

	connector	L mm	sec. Ø	available for
98551	M + F	1000 m	3 x 0,35 mm ²	Ribbon Dynamic
98552	M + F	3000 m	3 x 0,35 mm ²	Ribbon Dynamic

RGB Strips | Câble à prises multiples



RTG

	connector	L mm	sec. Ø	available for
89122	F	300	4 x 0,35 mm ²	Ribbon RGB Dropper RGB

RGB Strips | Rallonge pour prises multiples



RTG

	connector	L mm	sec. Ø	available for
89124	M + F	1000	2 x 0,35 mm ²	Ribbon RGB
89126	M + F	3000	2 x 0,35 mm ²	Dropper RGB

LED Strips | Câble à prises multiples



RTG

	connector	available for
89120	6 M	Ribbon RGB Dropper RGB

LED Strips | Câble IP66



RTG

	connector	L mm	sec. Ø	available for
89629	1 M	1000	2 x 0,75 mm ²	Silicone_C mono

LED Strips | Rallonge IP66



RTG

	connector	L mm	sec. Ø	available for
99000	1 F	2000	2 x 0,75 mm ²	Silicone_C mono

RGB Strips | Câble IP66



RTG

	connector	L mm	sec. Ø	available for
89630	1 M	2000	4 x 0,35 mm ²	Silicone_C RGB

RGB Strips | Rallonge IP66



RTG

	connector	L mm	sec. Ø	available for
99001	1 F	2000	4 x 0,35 mm ²	Silicone_C RGB

Vojo_17/08 | Low surface profile | Indoor LED Strips

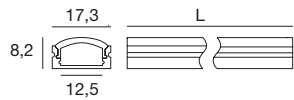

		L mm	
Anod. AL	98891	2000	Profilo - Profile
Black	83129	2000	Profilo - Profile
Transp.	98941	2000	Diffusore - Diffuser
Satinized	98942	2000	Diffusore - Diffuser
Opaline	98943	2000	Diffusore - Diffuser
Black	83132	2000	Diffusore - Diffuser
	98892	2 x	Tappi - Caps
Black	83133	2 x	Tappi - Caps
	98944	5 x	Staffe - Brackets

KIT composition			
1 x	98954	98891-98943-98892-98944	
10 x	98955	98891-98943	

Compatible with: Ribbon - Ribbon Plus - Ribbon slim - Dropper

RTG 98891 / 83129 / 98941 / 98942 / 98943
83132 / 83133 / 98954 / 98955

Luno_20/27 | Low surface profile | Indoor LED Strips

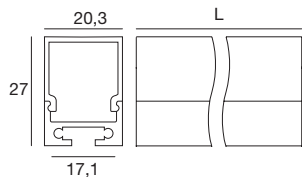

		L mm	
Anod. AL	98929	2000	Profilo - Profile
Black	83137	2000	Profilo - Profile
Opaline	98930	2000	Diffusore - Diffuser
Black	83138	2000	Diffusore - Diffuser
	98932	2 x	Tappi - Caps
Black	83139	2 x	Tappi - Caps
	98931	5 x	Staffe - Brackets

KIT composition			
10 x	99986	98929-98930	

Compatible with: Ribbon - Ribbon Plus - Ribbon slim - Dropper

RTG 98929 / 98930 / 83138 / 98932 / 83139 / 98931 / 99986

Vojo_17/08 | Low surface profile | Indoor LED Strips

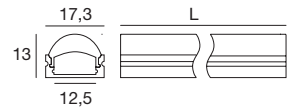

		L mm	
Anod. AL	98891	2000	Profilo - Profile
Satinized	98925	2000	Diffusore - Diffuser (90°)
	98928	2 x	Tappi - Caps
	98944	5 x	Staffe - Brackets

KIT composition			
1 x	99983	98891-98925-98928-98944	
10 x	99984	98891-98943	

Compatible with: Ribbon - Ribbon Plus - Ribbon slim - Dropper

RTG 98891 / 98925 / 98928 / 98944 / 99983 / 99984

Luno_20/27 | Low surface profile | Indoor LED Strips

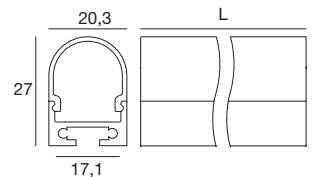
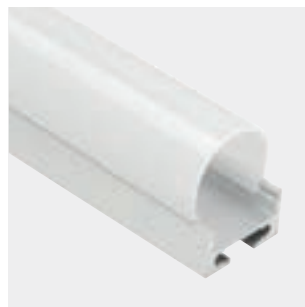

		L mm	
Anod. AL	98929	2000	Profilo - Profile
Black	83137	2000	Profilo - Profile
Opaline	98934	2000	Diffusore - Diffuser
Black	83183	2000	Diffusore - Diffuser
	98936	2 x	Tappi - Caps
Black	83184	2 x	Tappi - Caps
	98931	5 x	Staffe - Brackets

KIT composition			
10 x	99988	98929-98934	

Compatible with: Ribbon - Ribbon Plus - Ribbon slim - Dropper

RTG 98929 / 83137 / 98934 / 83183 / 83184 / 98936 / 98931 / 99988

Rive_17/16 | Low surface profile | Indoor LED Strips

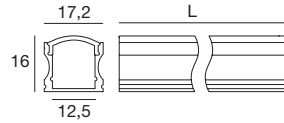
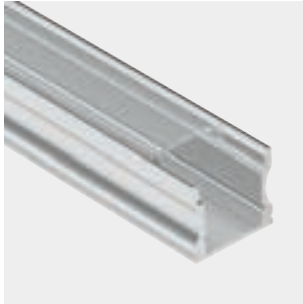

		L mm	
Anod. AL	98893	2000	Profilo - Profile
Black	83130	2000	Profilo - Profile
Transp.	98941	2000	Diffusore - Diffuser
Satinized	98942	2000	Diffusore - Diffuser
Opaline	98943	2000	Diffusore - Diffuser
Black	83132	2000	Diffusore - Diffuser
	98894	2 x	Tappi - Caps
Black	83135	2 x	Tappi - Caps
	98944	5 x	Staffe - Brackets

KIT composition			
1 x	99905	98893-98943-98894-98944	
10 x	99906	98893-98943	

Compatible with: Ribbon - Ribbon Plus - Ribbon slim - Dropper - Silicone_C - PU_C Plus

RTG 98893 / 83130 / 98941 / 98942 / 98943 / 98894 / 83135 / 98944 / 99905 / 99906

Sageto_24/08 | Low surface profile | Indoor LED Strips

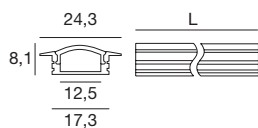
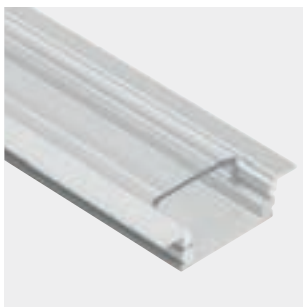

		L mm	
Anod. AL	98895	2000	Profilo - Profile
Transp.	98941	2000	Diffusore - Diffuser
Satinized	98942	2000	Diffusore - Diffuser
Opaline	98943	2000	Diffusore - Diffuser
	98896	2 x	Tappi - Caps
	98944	5 x	Staffe - Brackets

KIT composition			
1 x	98965	98895-98943-98896-98944	
10 x	99907	98895-98943	

Compatible with: Ribbon - Ribbon Plus - Ribbon slim - Dropper

RTG 98895 / 98941 / 98942 / 98943 / 98896 / 98944 / 98965 / 99907

Example with black profile + black diffuser.

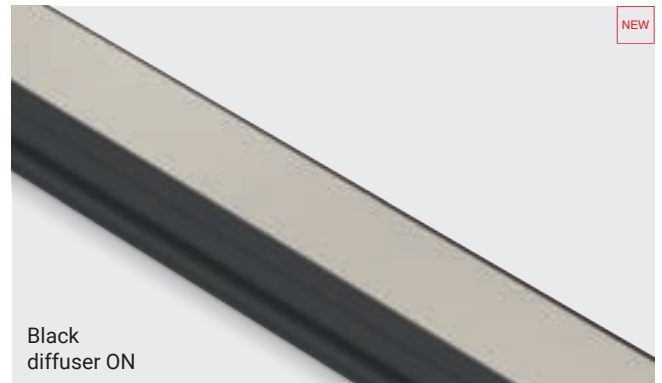

Roko_33/15 | Low surface profile | Indoor LED Strips

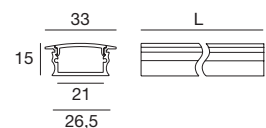
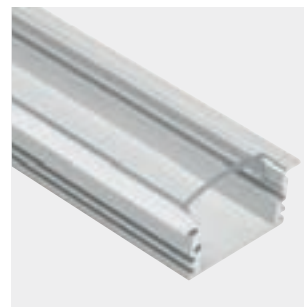

		L mm	
Anod. AL	98897	2000	Profilo - Profile
Transp.	98898	2000	Diffusore - Diffuser
Satinized	98899	2000	Diffusore - Diffuser
Opaline	98900	2000	Diffusore - Diffuser
	98902	2 x	Tappi - Caps
	98901	5 x	Staffe - Brackets

KIT composition			
1 x	99908	98897-98900-98902-98901	

Compatible with: Ribbon - Ribbon Plus - Ribbon slim - Dropper - Silicone_C - PU_C Plus

RTG 98897 / 98898 / 98899 / 98900 / 98902 / 98901 / 99908

Ghost_64/14 | Low surface profile | Indoor LED Strips

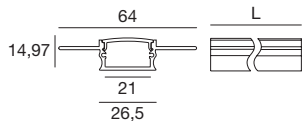

		L mm	
Anod. AL	98906	2000	Profilo - Profile
Transp.	98898	2000	Diffusore - Diffuser
Satinized	98899	2000	Diffusore - Diffuser
Opaline	98900	2000	Diffusore - Diffuser
	98907	2 x	Tappi - Caps

KIT composition		
1 x	99989	98906-98900-98907

Compatible with: Ribbon - Ribbon Plus - Ribbon slim - Dropper - Silicone_C - PU_C Plus

RTG 98906 / 98898 / 98899 / 98900 / 98907 / 99989

Papilio_41/41 | Low surface profile | Indoor LED Strips

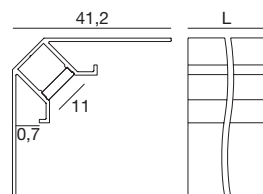
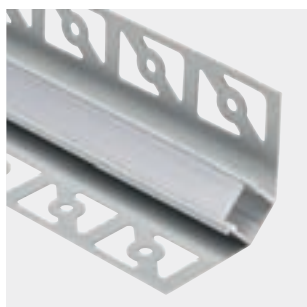

		L mm	
Anod. AL	98919	2000	Profilo - Profile
Opaline	98917	2000	Diffusore - Diffuser
	98920	2 x	Tappi - Caps

Compatible with: Ribbon - Ribbon Plus - Ribbon slim - Dropper

RTG 98919 / 98917 / 98920

Armata_58/15 | Low surface profile | Indoor LED Strips

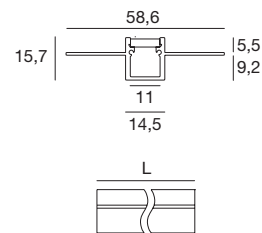

		L mm	
Anod. AL	98916	2000	Profilo - Profile
Opaline	98917	2000	Diffusore - Diffuser
	98918	2 x	Tappi - Caps

Compatible with: Ribbon - Ribbon Plus - Ribbon slim - Dropper

RTG 98916 / 98917 / 98918

Tabulo_35/14 | Low surface profile | Indoor LED Strips

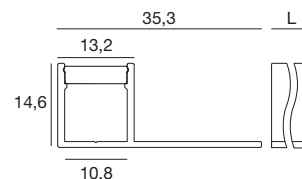

		L mm	
Anod. AL	98921	2000	Profilo - Profile
Opaline	98917	2000	Diffusore - Diffuser
	98922	2 x	Tappi - Caps

Compatible with: Ribbon - Ribbon Plus - Ribbon slim - Dropper

RTG 98921 / 98917 / 98922

Ribba_09/15 | Low surface profile | Indoor LED Strips

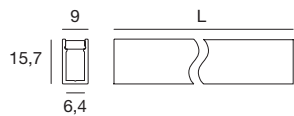
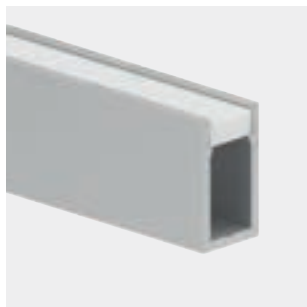

		L mm	
Anod. AL	98908	2000	Profilo - Profile
Opaline	98909	2000	Diffusore - Diffuser
	98911	2 x	Tappi - Caps
	98910	5 x	Staffe - Brackets

KIT composition		
10 x	99998	98908-90909

Compatible with: Ribbon slim

RTG 98908 / 98909 / 98911 / 98910 / 99998

Fonis_06/11 | Low surface profile | Indoor LED Strips

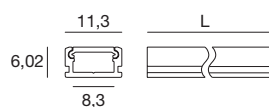

		L mm	
Anod. AL	98885	2000	Profilo - Profile
Transp.	98886	2000	Diffusore - Diffuser
Satinized	98887	2000	Diffusore - Diffuser
Opaline	98888	2000	Diffusore - Diffuser
	98890	2 x	Tappi - Caps
	98889	5 x	Staffe - Brackets

KIT composition		
1 x	83003	98885-98888-98890-98889
10 x	83004	98885-98888

Compatible with: Ribbon slim

RTG 98885 / 98886 / 98887 / 98888 / 98890 / 98889 / 83003 / 83004

Alise_10/10 | Low surface profile | Indoor LED Strips

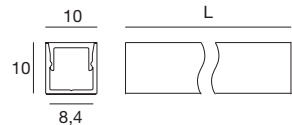

		L mm	
Anod. AL	98912	2000	Profilo - Profile
Opaline	98913	2000	Diffusore - Diffuser
	98915	2 x	Tappi - Caps
	98914	5 x	Staffe - Brackets

KIT composition		
10 x	83002	98912-98913

Compatible with: Ribbon slim

RTG 98912 / 98913 / 98915 / 98914 / 83002

Suo_56/10 | Low surface profile | Indoor LED Strips

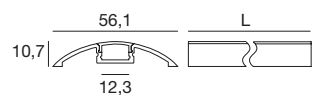

		L mm	
Anod. AL	98937	2000	Profilo - Profile
Opaline	98938	2000	Diffusore - Diffuser
	98940	2 x	Tappi - Caps
	98939	5 x	Staffe - Brackets

KIT composition		
10 x	83006	98937-98943

Compatible with: Ribbon - Ribbon Plus - Ribbon slim - PU_C Plus

RTG 98937 / 98943 / 98940 / 98939 / 83006

Ozner_25/10 | Low surface profile | Indoor LED Strips

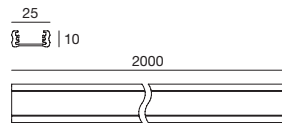

	L mm	
Anod. AL. 98419	2000	Profilo - Profile
Opaline 98395	2000	Diffusore - Diffuser
98418	2 x	Tappi - Caps
98420	5 x	Staffe - Brackets

Compatible with: Ribbon - Ribbon Plus - Ribbon slim - Dropper - Silicone_C - PU_C Plus

RTG 98419 / 98395 / 98418 / 98420

Svik_00/00 | Low surface profile | Indoor LED Strips

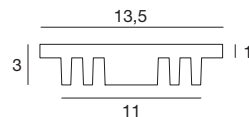

	L mm	
Anod. AL. 98956	2000	Dissipatore - Heat sink

KIT composition		
10 x	99999	99895

Compatible with: Ribbon - Ribbon Plus - Ribbon slim - Dropper - Silicone_C - PU_C Plus

RTG 98956 / 99999

Cela_18/18 | Low surface profile | Indoor LED Strips

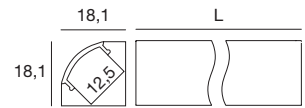

	L mm	
Anod. AL. 98903	2000	Profilo - Profile
Black 83131	2000	Profilo - Profile
Transp. 98941	2000	Diffusore - Diffuser
Satinized 98942	2000	Diffusore - Diffuser
Opaline 98943	2000	Diffusore - Diffuser
Black 83132	2000	Diffusore - Diffuser
98905	2 x	Tappi - Caps
Black 83136	2 x	Tappi - Caps
98904	5 x	Staffe - Brackets

KIT composition		
1 x	99910	98903-98943-98905-98904
10 x	99911	98903-98943

Compatible with: Ribbon - Ribbon Plus - Ribbon slim - Dropper

RTG 98903 / 83131 / 98941 / 98942 / 98943 / 98905 / 83136 / 98904 / 99910 / 99911

Example with black profile + black diffuser.

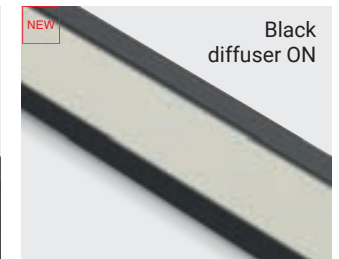

Narp_12/12 | Low surface profile | Indoor LED Strips

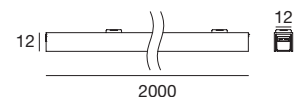
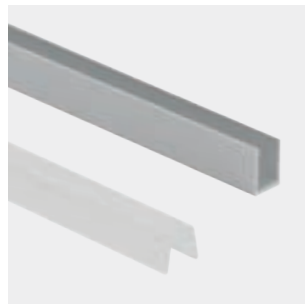

	L mm	
Anod. AL. 63560L2	2000	

Compatible with: Ribbon - Dropper

RTG 63560L2

Ice_14/11 | Low surface profile | Indoor LED Strips

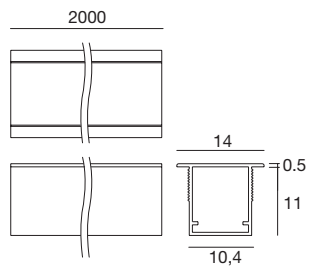

	L mm	
Anod. AL. 99977	2000	Profilo - Profile
99976	2 x	Tappi - Caps

Compatible with: Ribbon - Ribbon slim - Dropper

RTG 99977 / 99976

Ice_10/10 | Low surface profile | Indoor LED Strips

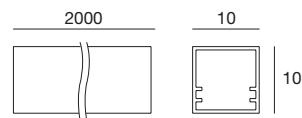

	L mm	
Anod. AL. 99979	2000	Profilo - Profile
99978	2 x	Tappi - Caps
98398	5 x	Clips di fissaggio - Fixing clips

Compatible with: Ribbon - Ribbon slim - Dropper

RTG 99979 / 99978 / 98398

GavriiLux FourSeasons Astir | Greece



electronics range index

Indoor			
	Bluetooth	Hendriks	922
		Cherokee	922
		Easyfit	922
		Mura	922
Costant current	Over voltage protection	Defender	923
	On/Off	Bit	924
		Slim	924
		Simon	924
		Leon	925
		Jeti	925
		Wade	925
		Smart 50	926
	Triac	Edge	926
		WT	926
	0/1-10V	Maxi JOLLY HV	926
		Slim	927
		Simon	927
		Boson	927
		WT	927
	DALI	Slim	928
		Simon	928
		Argo	928
		Planck	929
		WT	929
	DALI 2	Dynamic Drive	928
		DualDrive	929
		Maxi JOLLY	929
		Maxi JOLLY HV	930
		Lco	930
Converter CC	0/1-10V	Slim	930
	DALI	Slim	930
Costant voltage	On/Off	Slim	931
		Fusion	931
		Reson_75	931
		Peta	932
		Peta / Exa	932
		Peta	932
		Peta / Exa	932
		Peta / Exa	932
		Peta / Exa	932
		Peta / Exa	933
		Peta	933
	On/Off + N/O button	KIT_RESON	934
		KIT_RESON	934
	DALI	Trid	934
Converter CV	N/O button	Nyquist	935
	DALI 0/1-10V	Bode	935
	DALI	Berda mini	935
	DALI	Berda Maxi	935
Outdoor			
Costant current	On/Off	Mini_Penny	936
		Mini_Aqualed	936
		Penny_Q	936
		Penny	937
		Aqualed	937
		Maxi_Aqualed	937
	0/1-10V	Mean	938
	DALI 2	Aqualed_DALI	938
	DALI	Mean	939
		Mean	939
		Mean	939

Constant voltage	On/Off	AquaLED	940	
		Lingotto	940	
		Maxi_AquaLED	940	
		Giant_AquaLED	940	
		Reson_150	941	
		Mean	941	
		Mean On/Off Driver 48V	941	
		Mean On/Off Driver 48V	941	
		Mean On/Off 12V	942	
		Mean On/Off 12V	942	
		0/1-10V	Reson_150	943
		DALI	Mean DALI driver 12V	942
			Mean DALI driver 12V	942
			Mean DALI Driver 24V	943
			Mean DALI Driver 24V	943
Mean DALI Driver 48V	943			
Converter CV	On/Off	Round	944	
Master & Controller	RF remote	Smart RF remote	944	
		Smart RF remote	945	
	TRIAC Controller	Eltako	945	
	DALI power Supply	Dali_PS2	946	
		Dali_PS1	946	
	DALI Controller	Dali_USB	947	
		Dali_XC	947	
		UPB4	948	
		SceneCOM	948	
		Pannel DALI	948	
		basicDIM DGC	basicDIM DGC Digital controller	949
		basicDIM DGC Sensor 5DPI 14rc	949	
		basicDIM DGC Full Programmer	949	
		basicDIM DGC Easy Programmer	949	
	DMX	Real_T	950	
	DMX/RDM	Dalc MAXI CC DMX/RDM 4ch	950	
		Dalc Mono CV DMX/RDM 1ch	951	
		Dalc Maxi CV DMX/RDM 4ch	951	
	DMX	Spectrum DMX 4ch	951	
	DMX Controller	Slesa_UE7 DMX Controller	952	
	DMX/RDM Controller	Dina DR1 DMX controller	952	
	DMX Controller	Stick_GU2 DMX Controller	953	
		Stick_DE3 DMX Controller	953	
	ArtNet RDM/DMX controller	Pixie_PIXEL box	954	
		Paseo_PIXEL box	954	
		Pix2048	954	
	ArtNet DMX Recorder	Pixout	955	
	converter ArtNet DMX\RDM	Pixtwo	955	
	Splitter line isolator Boost DMX/RDM	Line isolator DMX	955	
		Splitter Visual	956	
		Splitter SWI	956	
	ArtNet DMX controller	Titan	956	
		Pro Mk2	956	
	ArtNet converter	DMXnode	957	
		Key Madrix 5	957	
		WS WorkStation HP	957	
		MHD Monitor	957	
		HPE Ethernet Switch	957	
	Emergency Kit			
	Emergency	Emergency light kit Emergency	958	
		Emergency light kit Emergency	959	



CONFIGURER VOTRE RÉSEAU

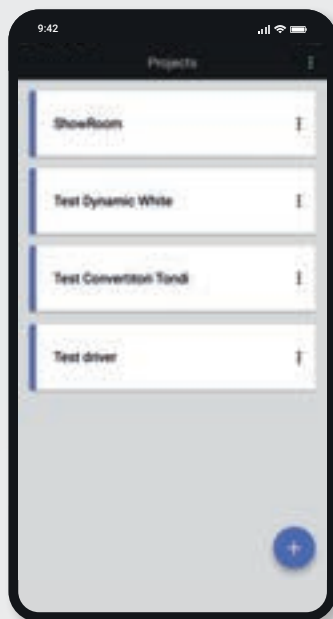

1. Définir les zones à contrôler simplement en quelques étapes.



2. Télécharger vos plans et configurer les appareils.

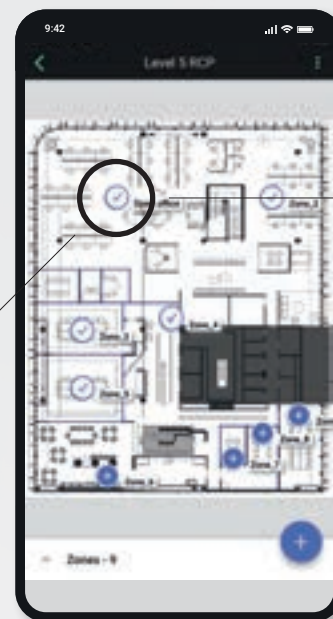

3. Après configuration des zones, l'app. Silvair vous permet d'accéder dans n'importe quelle zone de la pièce sélectionnée.

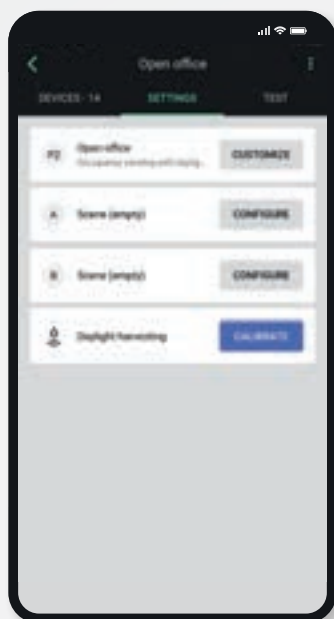

6. Il est possible de paramétrer simplement en quelques étapes des scénarios personnalisables en fonction des besoins.

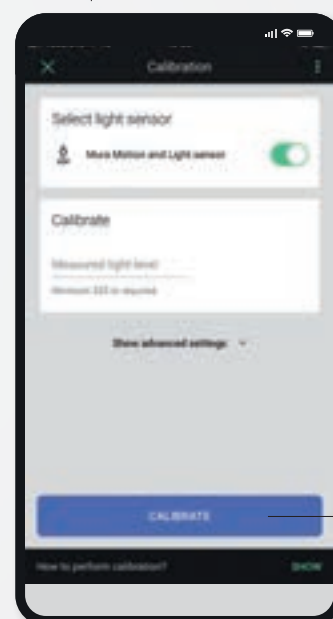
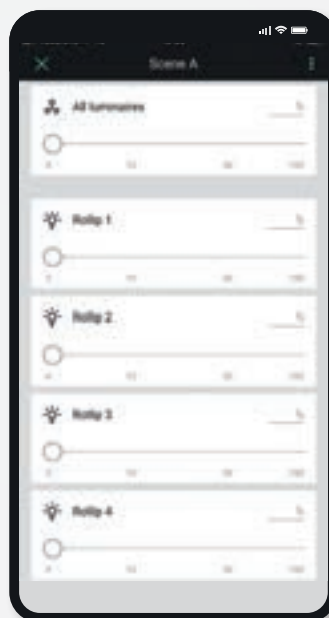

7. Le capteur Mura peut être calibré en sélectionnant la quantité de lumière désirée dans une zone déterminée, ce qui permet de régler l'éclairage des pièces selon les besoins des utilisateurs.

Technology Partner
SILVAIR

920

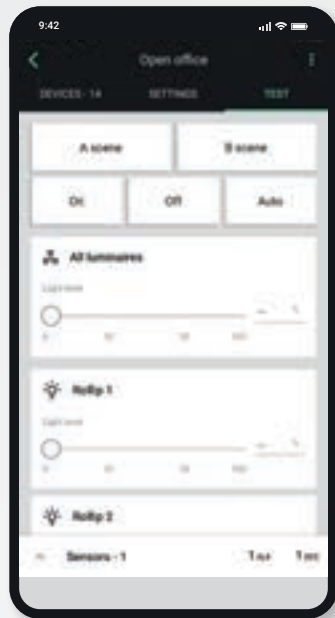

4. Le tableau de contrôle permet de gérer tous les appareils en même temps ou individuellement, et de personnaliser les niveaux d'éclairage lumineux dans l'ensemble du bâtiment.

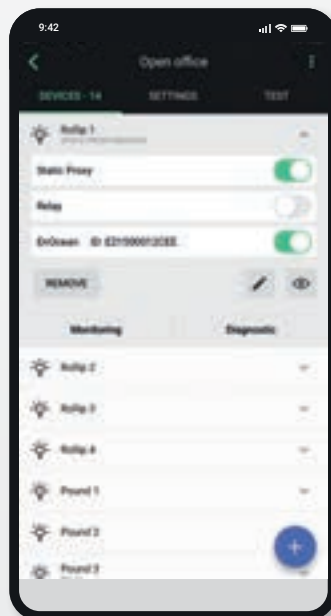
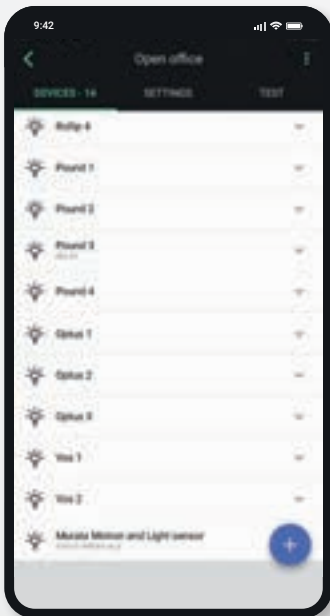
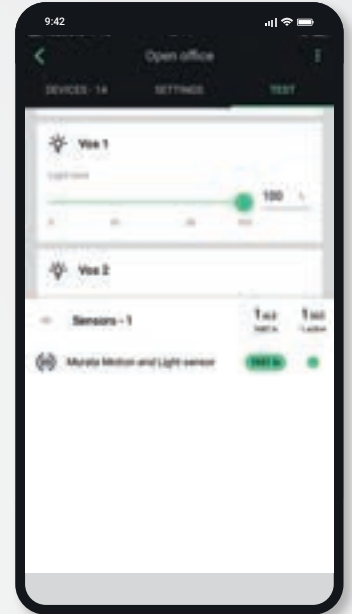
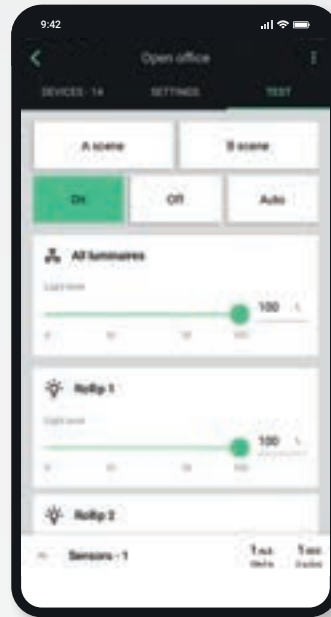

5. Le capteur Mura Sensor permet de configurer les appareils et d'autonomiser le système d'allumage, d'extinction et de gradation, en garantissant une plus grande économie d'énergie.

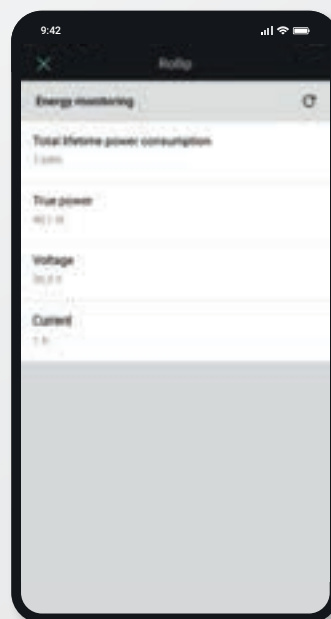

8. Le système permet de surveiller l'état de chaque appareil, en garantissant un contrôle immédiat des consommations dans les différentes pièces paramétrées.



Mura Sensor
Capteur avec Bluetooth mesh approuvé, adapté au contrôle drivers DALI avec une alimentation de bus DALI supplémentaire.
Pag. 922.

Hendriks | Driver Bluetooth mesh

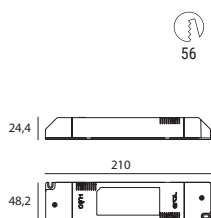

	range	output	input	eff.	PF	surge
83104	12W DC arrayLED	350 mA 37V	198~264 V AC	71%	0.85 C	4kV
83105	15W DC arrayLED	400 mA 37V	198~264 V AC	73%	0.87 C	4kV
83106	25W DC arrayLED	700 mA 37V	198~264 V AC	79%	0.93 C	4kV
83107	35W DC arrayLED	950 mA 37V	198~264 V AC	84%	0.96 C	4kV

Driver avec Bluetooth mesh approuvé, doté d'une sortie à courant constant qui le rend idéal pour toute application indépendante de 12 W à 35 W.

Cherokee | Controller Bluetooth mesh 0/1-10V 2 uscite 24/48 V DC

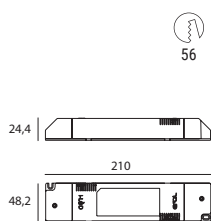

	range	output	input	surge
83189	2ch. x (1- 96W stripLED/ch.)	2xch 4A 24V	198-264 V AC	1kV
	2ch. x (1- 72W stripLED/ch.)	2xch 3A 48V	198-264 V AC	

Contrôleur avec Bluetooth mesh approuvé, doté de deux sorties 24/48 VDC. Convient pour le contrôle de drivers avec interface 0/1-10V. Fonction de compteur de puissance sur le primaire qui permet de mesurer la puissance absorbée et l'énergie consommée pendant tout le cycle de vie de l'article. La portée du signal peut atteindre 30 m à vol d'oiseau et 10 m dans un environnement fermé.

Easyfit | switch Bluetooth

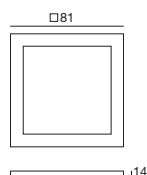

	type	frequency	range
83017	White	Radio Frequency 2.4 GHz	wireless 10m

Interrupteur qui transmet son statut selon la technologie Bluetooth à basse consommation. Ne nécessite pas d'alimentation. La portée du signal est de 10 m en espace clos.

Mura | sensor Bluetooth mesh

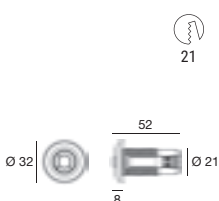

	type	frequency	range
83016	White	Radio Frequency 2.4 GHz	wireless 10m

99309
Power Supply

Capteur avec Bluetooth mesh approuvé, adapté au contrôle de drivers DALI avec une alimentation bus DALI supplémentaire. Le capteur est de type LUX/PIR. Hauteur maximale installable 3 m. La portée du signal est de 10 m en espace clos.



46

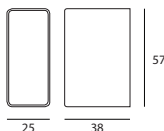

	U_N	I_N	I_{MAX}	I_{TOT}	U_{OC}	U_P
99341	230V AC	5kA	10kA	20kA	10kV	$\leq 1.5kV$
U_N	Nominal operating Voltage					
I_N	Nominal impulse discharge current					
I_{MAX}	Total impulse current (L+N+PE)					
I_{TOT}	Max. total impulse current (L+N+PE)					
U_{OC}	Surge protection level [L-N] [L+N-PE]					
U_P	Voltage protection level [L-N] [L/N-PE]					

Parafoudre pour décharges indirectes de type T3 (CEI EN 61643-11/A11) avec classification d'essai III (CEI EN 61643-11 Ed.1).
 Limiteur de surtension multipolaire avec éclateur et varistors connectés en série aux phases actives.
 Construction de type combiné, à amorçage avec limitation.
 Absence de courant de fuite.
 Absence courant de suite en raison de la combinaison en série varistor/éclateur.

Règles d'installation

L'installation d'un seul parafoudre en entrée sur chaque ligne peut s'avérer insuffisante pour garantir une protection efficace de l'ensemble du système. Tous les luminaires installés à une distance de 10 m en aval du parafoudre sont considérés comme protégés à 100 %. Si la longueur du câble entre le parafoudre et les luminaires dépasse les 10 m, il est conseillé de renouveler la protection en plaçant un autre parafoudre près des appareils à protéger (à une distance inférieure à 10 m). Afin de garantir un niveau de protection maximal, installer les parafoudres de la manière décrite à côté pour chaque ligne du système.

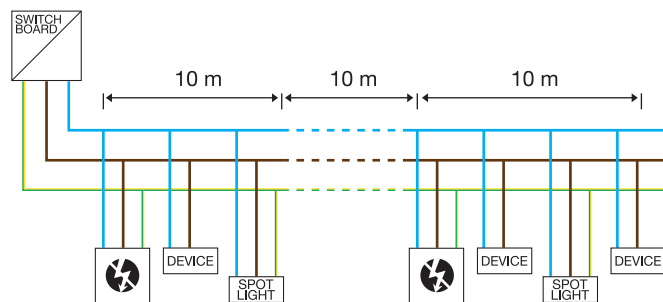
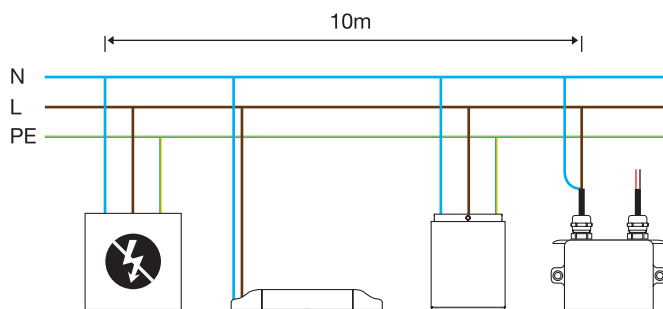

Bit | On/Off Driver

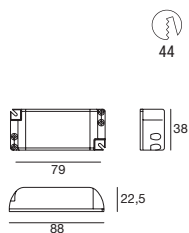

	range	output	input	eff.	PF	surge
99243	6.5W DC arrayLED	700mA 10V	100~240V AC	80%	0.6 C	0.5 kV
99370	10W DC arrayLED	300mA 36V	100~240V AC	80%	0.6 C	0.5 kV

Protection à réarmement automatique contre la surchauffe, la surcharge, les circuits ouverts et les courts-circuits sur la ligne de sortie.

Slim | On/Off Driver

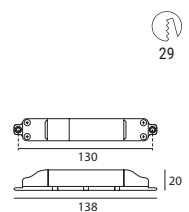

	range	output	input	eff.	PF	surge
99307	0.6-1.4W DC powerLEDs	220mA 6.6V	198~264V AC	80%	0.6 C	4 kV
83007	2-5W DC powerLEDs	220mA 20V	198~264V AC	80%	0.9 C	2 kV
89144	1-2W DC powerLEDs 1-2.5W DC topLED	350mA 6.6V	198~264V AC	80%	0.6 C	4 kV
89145	3-6W DC powerLEDs 3.5-7W DC topLED	350mA 20V	198~264V AC	80%	0.6 C	4 kV
99375	6-12W DC powerLEDs	350mA 40V	198~264V AC	80%	0.9 C	2 kV
99195	1.5-3W DC powerLEDs	500mA 6.6V	198~264V AC	80%	0.6 C	4 kV
89146	3-4.5W DC powerLEDs	500mA 10V	198~264V AC	80%	0.6 C	4 kV
99377	4.5-9W DC powerLEDs	500mA 20V	198~264V AC	80%	0.9 C	2 kV
89147	2-4W DC powerLEDs	630mA 6.6V	198~264V AC	80%	0.6 C	4 kV
99376	6-12W DC powerLEDs	630mA 20V	198~264V AC	80%	0.9 C	2 kV

Smartwave™ : excellente efficacité, longue durée de vie, protection contre les surtensions, PF élevé. Protection à réarmement automatique contre la surchauffe, la surcharge, les circuits ouverts et les courts-circuits sur la ligne de sortie.

Simon | On/Off Driver

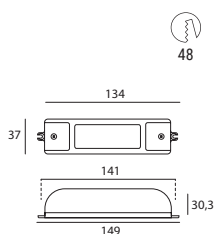

	range	output	input	eff.	PF	surge
99198	8W DC arrayLED 3-7W DC powerLEDs 8W DC topLED	220mA 39V	198~264V AC	89%	0.9 C	4 kV
99126	13.5W DC topLED 6-12W DC powerLEDs	350mA 39V	198~264V AC	89%	0.9 C	4 kV
99128	4.5-9W DC powerLEDs	500mA 20V	198~264V AC	89%	0.9 C	4 kV
99129	6-12W DC powerLEDs	630mA 20V	198~264V AC	89%	0.9 C	4 kV
99734	8W DC arrayLED 11W DC arrayLED 15W DC arrayLED	220mA 37V 300mA 37V 400mA 37V	198~264V AC	82%	0.96	2 kV
99735	6W DC powerLEDs 6.5-7W DC arrayLED 10W DC powerLEDs	500mA 12V 700mA 9-12V 800mA 12V	198~264V AC	74%	0.96	2 kV

	range	output	input	eff.	PF	surge
99260	13W DC topLED	350mA 36V	190~250V AC	89%	0.9 C	4 kV
99740	8W DC arrayLED 11W DC arrayLED 15W DC arrayLED	220mA 37V 300mA 37V 400mA 37V	190~250V AC	82%	0.96	2 kV

Smartwave™ : excellente efficacité, longue durée de vie, protection contre les surtensions, PF élevé. Protection contre la surchauffe, la surcharge, les circuits ouverts et les courts-circuits sur la ligne de sortie. Pour les codes 99734, 99735 et 99740, sélection du courant via cavalier.

Connecteur Easy Plug inclus pour les codes **99260, 99740**



Leon | On/Off Driver

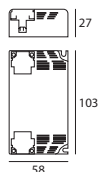

Connecteur Easy Plug inclus pour les codes **99261, 99093, 99146, 99112**

	range	output	input	eff.	PF	surge
99106	9-18W DC powerLEDs 19W DC topLED	500mA 39V	198~264V AC	91%	0.95	4 kV
99105	12-24W DC powerLEDs	630mA 39V	198~264V AC	91%	0.95	4 kV
99147	25W DC arrayLED	700mA 37V	198~264V AC	91%	0.95	4 kV
99135	30W DC arrayLED 30W DC topLED	840mA 39V	198~264V AC	91%	0.95	4 kV
99239	35W DC arrayLED	950mA 37V	198~264V AC	89%	0.95	4 kV

	range	output	input	eff.	PF	surge
99261	23W DC topLED	630mA 36V	198~264V AC	91%	0.95	4 kV
99112	25W DC arrayLED	700mA 37V	198~264V AC	91%	0.95	4 kV
99093	30W DC arrayLED 30W DC topLED	840mA 39V	198~264V AC	91%	0.95	4 kV
99146	35W DC arrayLED	950mA 37V	198~264V AC	89%	0.95	4 kV

Smartwave™ : excellente efficacité, longue durée de vie, protection contre les surtensions, PF élevé. Protection contre la surchauffe, la surcharge, les circuits ouverts et les courts-circuits sur la ligne de sortie.

Jeti | On/Off Driver

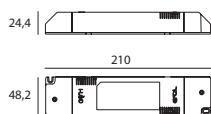

Connecteur Easy Plug inclus pour les codes **83113, 83114**



	range	output	input	eff.	PF	surge
83111	40W DC arrayLED	1100mA 37V	198~264 V AC	90%	0.9	4 kV
83113	40W DC arrayLED	1100mA 37V	198~264 V AC	90%	0.9	4 kV

	range	output	input	eff.	PF	surge
83112	50W DC arrayLED	1250mA 37V	198~264 V AC	90%	0.9	4 kV
83114	50W DC arrayLED	1250mA 37V	198~264 V AC	90%	0.9	4 kV

Smartwave™ : excellente efficacité, longue durée de vie, protection contre les surtensions, PF élevé. Protection contre la surchauffe, la surcharge, les circuits ouverts et les courts-circuits sur la ligne de sortie.

Wade | On/Off Driver

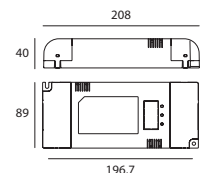

	range	output	input	eff.	PF	surge
99717	70W DC topLED	1.75A 37V	198~264V AC	88%	0.97	5 kV
99718	90W DC topLED	2.25A 37V	198~264V AC	88%	0.97	5 kV

Protection contre la surchauffe, la surcharge, les circuits ouverts et les courts-circuits sur la ligne de sortie.



Smart 50 | On/Off Driver

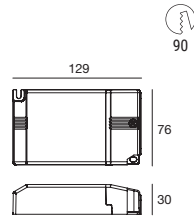

	range	output	input	eff.	PF	surge
83122	38 W DC powerLEDs	600mA 60V	198~264V AC	90%	0.95	2 kV
	46 W DC powerLEDs	600mA 72V				

Protection contre la surchauffe, la surcharge, les circuits ouverts et les courts-circuits sur la ligne de sortie.

Edge | Triac Multi Current

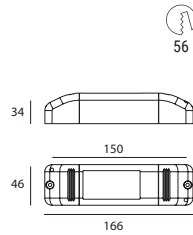

	range	output	input	eff.	PF	surge
99141	1-12 W DC powerLEDs	350mA 39V	198~264V AC	85%	0.97	1 kV
	1.5-18 W DC powerLEDs	500mA 39V				
	2-24 W DC powerLEDs	550mA 39V				
	25 W DC arrayLED	700mA 37V				

Réglage via gradateur à coupure de phase ou TRIAC.
Fonctionnement également en 24 VDC, maximum 22 W.
Sélection de l'intensité du courant de sortie via commutateur DIP dédié.
Protection contre les surchauffes, les courts-circuits, les surcharges et les surtensions de secteur.

98436

Cable and connector

WT | Triac Multi Current

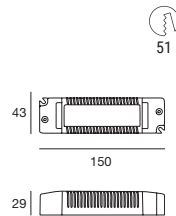

	range	output	input	eff.	PF	surge
99360	8 W arrayLED	250mA 37V	200~240V AC	88%	0.9	1 kV
	13 W arrayLED	350mA 37V				
	25 W arrayLED	700mA 37V				

Réglage via gradateur à coupure de phase ou TRIAC.
Sélection de l'intensité du courant de sortie via commutateur DIP.
Protection à réarmement automatique contre la surchauffe, la surcharge, les circuits ouverts et les courts-circuits sur la ligne de sortie.

98436

Cable and connector

Maxi JOLLY HV | 0/1-10V PUSH Multi Current

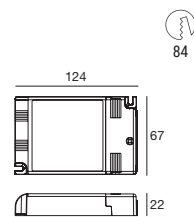

	range	output	input	eff.	PF	surge
83143	68 W DC powerLEDs	550mA 108V	99~264V AC	92%	0.95	4 kV

Driver multipower fourni avec dip-switch pour la sélection du courant de sortie. Protections: contre la surchauffe et les courts-circuits, contre les pointes de tension du réseau, contre les surcharges.
Régulation de la lumière 0/1 - 100% au moyen de la fonction PUSH, interface 0/1 ... 10 V (I = 1 mA) ou potentiomètre 100 Kohm.
Possibilité d'utiliser la fonction PUSH sur 4/5 pilotes sans câble de synchronisation.
La longueur maximale du câble, du bouton-poussoir au dernier pilote, doit être de max. 15 m.

Slim | 0/1-10V Driver



29

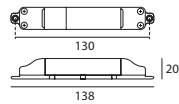

	range	output	input	eff.	PF	surge
99714	6 W DC powerLEDs	500mA 12V	198~264V AC	80%	0.6	4 kV

Réglages via interface 0/1-10 V ou potentiomètre. Assemblage driver + convertisseur.
Protection à réarmement automatique contre la surchauffe, la surcharge, les circuits ouverts et les courts-circuits sur la ligne de sortie.



Simon | 0/1-10V Multi Current



48

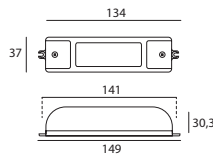

	range	output	input	eff.	PF	surge
99732 / 99739	8 W DC arrayLED	220mA 37V	198~264V AC	82%	0.96	2 kV
	11 W DC arrayLED	300mA 37V				
	15 W DC arrayLED	400mA 37V				

	range	output	input	eff.	PF	surge
99733	6 W DC powerLEDs	500mA 12V	198~264V AC	82%	0.96	2 kV
	6,5 W - 7 W DC arrayLED	700mA 9-12V				
	10 W DC powerLEDs	800mA 12V				

Sélection de l'intensité du courant de sortie via cavalier. Réglages via interface 0/1-10 V ou potentiomètre. Protection à réarmement automatique contre la surchauffe, la surcharge, les circuits ouverts et les courts-circuits sur la ligne de sortie.



Connecteur Easy Plug inclus pour les codes **99739**

Boson | 0/1-10V N/O button Multi Current



56

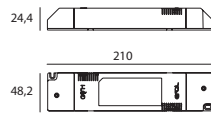

	range	output	input	eff.	PF	surge
99115	1-15 W DC powerLEDs	350mA 45V	198~264V AC	87%	0.6 C	4 kV
	15 W DC topLED	350mA 39V				
	1.5-18 W DC powerLEDs	500mA 39V				
	19 W DC topLED	500mA 39V				
	2-20 W DC powerLEDs	630mA 33V				

	range	output	input	eff.	PF	surge
99262	13 W DC topLED	350mA 37V	198~264V AC	87%	0.6 C	4 kV
	18 W DC topLED	500mA 37V				
	20 W DC topLED	630mA 33V				

Sélection de l'intensité du courant de sortie via une borne dédiée. Réglages via interface, ou potentiomètre 0/1-10 V, ou bouton NO. Possibilité de connecter jusqu'à 50 drivers (via bus Sync). Protection à réarmement automatique contre la surchauffe, la surcharge, les circuits ouverts et les courts-circuits sur la ligne de sortie.

WT | 0/1-10V Multi Current



56

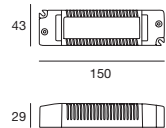

	range	output	input	eff.	PF	surge
99361	8 W DC arrayLED	250mA 37V	100~240V AC	88%	0.9	1 kV
	13 W DC arrayLED	350mA 37V				
	25 W DC arrayLED	700mA 37V				

Réglages via interface 1-10 V ou potentiomètre.
Sélection de l'intensité du courant de sortie via commutateur DIP.
Protection à réarmement automatique contre la surchauffe, la surcharge, les circuits ouverts et les courts-circuits sur la ligne de sortie.

98436
Cable and connector

Indoor CC dimmable driver

Slim | DALI Driver



29

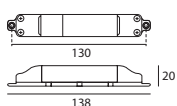

	range	output	input	eff.	PF	surge
99715	6W DC powerLEDs	500mA 12V	198~264V AC	80%	0.6	4 kV

Réglages via interface DALI. Optimisation du signal de transmission DALI. Assemblage driver + convertisseur. Protection à réarmement automatique contre la surchauffe, la surcharge, les circuits ouverts et les courts-circuits sur la ligne de sortie.

Simon | DALI Push and Simply Dim Multi Current



48

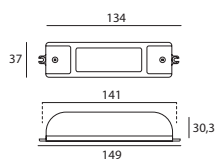

Connecteur Easy Plug inclus pour les codes **99738**

	range	output	input	eff.	PF	surge
99730 / 99738	8 W DC powerLEDs	220mA 37V	198~264 V AC	82%	0.96	2 kV
	11W DC arrayLED	300mA 37V				
	15W DC arrayLED	400mA 37V				
99731	6W DC powerLEDs	500mA 12V	198~264 V AC	74%	0.96	2 kV
	6.5-7W DC arrayLED	700mA 9-12V				
	10 W powerLEDs	800mA 12V				

Sélection de l'intensité du courant de sortie via cavalier. Réglages via interface DALI. Optimisation du signal de transmission DALI. Protection à réarmement automatique contre la surchauffe, la surcharge, les circuits ouverts et les courts-circuits sur la ligne de sortie.

Argo | DALI Push and Simply Dim Multi Current



56

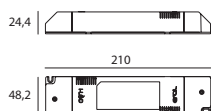

Connecteur Easy Plug inclus pour les codes **99721, 99330**

	range	output	input	eff.	PF	surge
99344 / 99721	1-12 W DC powerLEDs	350mA 39V	198~264V AC	83%	0.95	4 kV
	1.5-18 W DC powerLEDs	500mA 39V				
	2-24 W DC powerLEDs	630mA 39V				
99345 / 99330	25 W DC arrayLED	700mA 37V	198~264V AC	85%	0.95	4 kV
	30 W DC arrayLED	840mA 37V				
	35 W DC arrayLED	950mA 37V				

Réglages via interface DALI ou Simply Dim. Optimisation du signal de transmission DALI. Sélection de l'intensité du courant via une borne dédiée. Protection à réarmement automatique contre la surchauffe, la surcharge, les circuits ouverts et les courts-circuits sur la ligne de sortie.

Dynamic Drive | DRIVER DALI 2 DT8 2CH



66

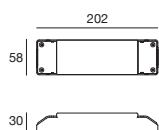

	range	output	input	eff.	PF	surge
83159	16-25W DC arrayLED	700mA 37V	198-264V AC	88%	0.9	1kV

Paramètres via l'interface DALI. Driver pour Dinamic White DT8. Niveau de gradation de 0 / 1-100%

Planck | DALI Multi Current

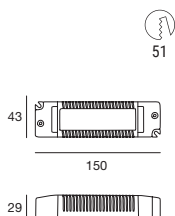

51

	range	output	input	eff.	PF	surge
99373	1-12W DC arrayLED	350mA 34V	100~240V AC	84%	0.9 C	0,5 kV
	1.5-12W DC powerLED	500mA 24V				
	1.5-12W DC powerLED	600mA 20V				

Recommandé pour un article 6 W ou 8 W, ou bien pour deux articles 6 W en série.
 Réglages via interface DALI.
 Optimisation du signal de transmission DALI.
 Sélection de l'intensité du courant de sortie via commutateur DIP.
 Protection à réarmement automatique contre la surchauffe, la surcharge, les circuits ouverts et les courts-circuits sur la ligne de sortie.

98436
Cable and connector

WT | DALI Multi Current

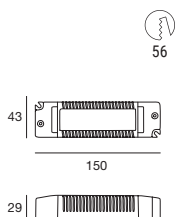

56

	range	output	input	eff.	PF	surge
99362	8 W DC arrayLED	250mA 37V	220~240V AC	85%	0.95	1 kV
	13 W DC arrayLED	350mA 37V				
	25 W DC arrayLED	700mA 37V				

Réglages via interface DALI.
 Optimisation du signal de transmission DALI.
 Sélection de l'intensité du courant de sortie via commutateur DIP.
 Protection à réarmement automatique contre la surchauffe, la surcharge, les circuits ouverts et les courts-circuits sur la ligne de sortie.

98436
Cable and connector

DualDrive | DRIVER DALI 2 DT8 2CH

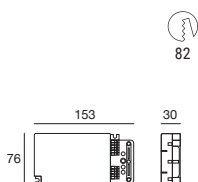

82

	range	output	input	eff.	PF	surge
83058	50W DC arrayLED	350mA 39V	120-250V AC	87%	0.9	2kV
83059	50W DC arrayLED	600mA 39V	120-250V AC	87%	0.9	2kV
83060	50W DC arrayLED	840mA 39V	120-250V AC	87%	0.9	2kV
83061	50W DC arrayLED	1250mA 39V	120-250V AC	87%	0.9	2kV

Paramètres via l'interface DALI.
 Driver pour Dinamic White DT8.
 Niveau de gradation de 0 / 1-100%

Maxi JOLLY | DALI 2 Push 0/1-10V Multi Current

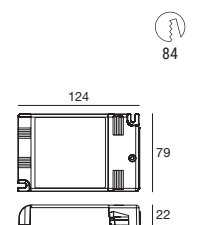

84

	range	output	input	eff.	PF	surge
83008 / 83066	4-18W DC powerLEDs	350mA 53V	99~264V AC	92%	0.96	4 kV
	6-26W DC powerLEDs	500mA 53V				
	8-31W DC powerLEDs	600mA 53V				
	15W DC arrayLED	400mA 37V				
	25W DC arrayLED	700mA 37V				
	30W DC arrayLED	850mA 37V				
	35W DC arrayLED	950mA 37V				
	45W DC arrayLED	1200mA 37V				

Driver multipower fourni avec dip-switch pour la sélection du courant de sortie. Protections: contre la surchauffe et les courts-circuits, contre les pointes de tension du réseau, contre les surcharges.
 RIPPLE FREE ≤ 3%.
 Sur demande certification BIS.
 Régulation de la lumière 0/1 - 100% au moyen de la fonction PUSH, interface 0/1 ... 10 V (I = 1 mA) ou potentiomètre 100 Kohm et DALI.
 Possibilité d'utiliser la fonction PUSH sur 4/5 pilotes sans câble de synchronisation.
 La longueur maximale du câble, du bouton-poussoir au dernier pilote, doit être de max. 15 m.

Connecteur Easy Plug inclus pour les codes **83066**

Slim |On/Off Driver

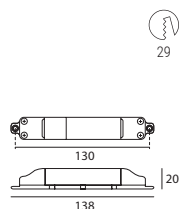

29

	range	output	input	eff.	PF	surge
89408	1-5W DC stripLED 200mA 24V	1A 24V	198~264V AC	80%	0.6 C	4 kV
	1-5W DC topLED					

Adapté à l'alimentation de bandes de LED, LED 5 mm et topLED à tension constante.
Protection à réarmement automatique contre les circuits ouverts et les courts-circuits sur la ligne de sortie.



Fusion |On/Off Driver

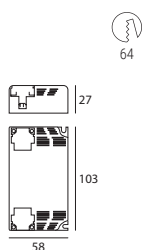

64

	range	output	input	eff.	PF	surge
84829	1-24W DC stripLED 1A 24V	1A 24V	198~264V AC	88%	0.6 C	2 kV
	1-24W DC topLED					

Adapté à l'alimentation de bandes de LED, LED 5 mm et topLED à tension constante.
Protection à réarmement automatique contre les circuits ouverts et les courts-circuits sur la ligne de sortie.



Reson_75 |On/Off Driver

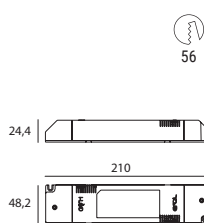

56

	range	output	input	eff.	PF	surge
99374	1-75 W DC stripLED	3.13A 24V	198~264V AC	91%	0.96	4 kV
	1-75 W DC topLED					

Adapté à l'alimentation de bandes de LED, LED 5 mm et topLED à tension constante.
Protection à réarmement automatique contre les circuits ouverts et les courts-circuits sur la ligne de sortie.
Efficacité élevée, longue durée de vie et PF élevé.



Peta | Switching Driver 50 W DC

 C.V.

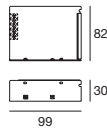

	type	output	input	cooling	PF
99371	Peta	2.2A 24V	88~264V AC	Natural Convection	No PFC

Protection à réarmement automatique contre les circuits ouverts et les courts-circuits sur la ligne de sortie.

Peta / Exa | Switching Driver 75 W DC

 C.V.

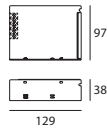

	type	output	input	cooling	PF
84700	Peta	3.2A 24V	88~264V AC	Natural Convection	No PFC

Protection à réarmement automatique contre les circuits ouverts et les courts-circuits sur la ligne de sortie.

Peta | Switching Driver 100 W DC

 C.V.

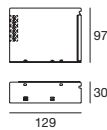

	type	output	input	cooling	PF
99372	Peta	4.2A 24V	88~264V AC	Natural Convection	No PFC

Protection à réarmement automatique contre les circuits ouverts et les courts-circuits sur la ligne de sortie.

Peta / Exa | Switching Driver 150 W DC

 C.V.

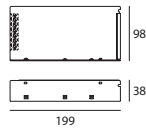

	type	output	input	cooling	PF
84701	Peta	6.5A 24V	88~264V AC	Natural Convection	No PFC

Protection à réarmement automatique contre les circuits ouverts et les courts-circuits sur la ligne de sortie.

Peta / Exa | Switching Driver 200 W DC

 C.V.

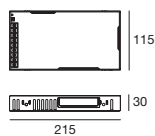

	type	output	input	cooling	PF
99682	Peta	8.4A 24V	88~264V AC	Natural Convection	0.95

Protection à réarmement automatique contre les circuits ouverts et les courts-circuits sur la ligne de sortie.

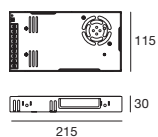

	type	output	input	cooling	PF
99683	Peta	13.4A 24V	88~264V AC	Forced conv.	0.95
99725	Exa	6.7A 48V	88~264V AC	Forced conv.	0.95

Protection à réarmement automatique contre les circuits ouverts et les courts-circuits sur la ligne de sortie.

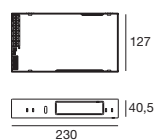

	type	output	input	cooling	PF
84787	Peta	21A 24V	88~264V AC	Forced conv.	0.95
84626	Exa	10A 48V	88~264V AC	Forced convection	0.95

Protection à réarmement automatique contre les circuits ouverts et les courts-circuits sur la ligne de sortie.

KIT_RESON | Driver + N/O button



56

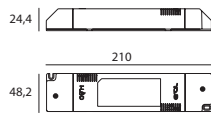

	range	output	input	eff. PF	surge
83018	1-75 W DC	3.13A 24V	198~264V AC	91% 0.96	4 kV



48

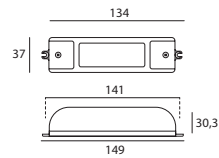

Adapté pour l'alimentation de bandes de LED et de LED 5 mm à tension constante. Gradation de 0 à 100 % avec le bouton N/A
 Chaque pilote peut fonctionner en tant que maître ou esclave.
 Possibilité de raccorder jusqu'à 20 pilotes avec le Bus Sync.
 Protection avec réarmement automatique contre la surchauffe, la surcharge, le circuit ouvert et le court-circuit sur la ligne.



KIT_RESON | Driver + N/O button



70

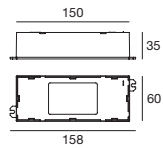

	range	output	input	eff. PF	surge
83019	150 W DC	6,25A 24V	198~264V AC	95% 0.98	4 kV



48

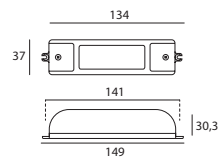

Adapté pour l'alimentation de bandes de LED et de LED 5 mm à tension constante. Gradation de 0 à 100 % avec le bouton N/A
 Chaque pilote peut fonctionner en tant que maître ou esclave.
 Possibilité de raccorder jusqu'à 20 pilotes avec le Bus Sync.
 Protection avec réarmement automatique contre la surchauffe, la surcharge, le circuit ouvert et le court-circuit sur la ligne.



Trid | Driver DALI PUSH



29

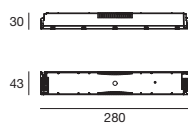

	range	output	input	eff. PF	surge
83062	150W DC	6.25A 24V	198-264V AC	94% 0.99	2 kV

Installation avec interface DALI.
 Pilote LED à tension constante de 24 V dimmable de 1 à 100 % avec interface DALI ou PUSH.

Nyquist | N/O button

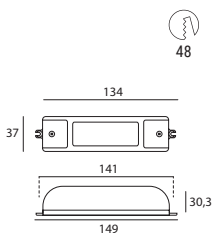

	range	output	input	eff.
99077	3ch. x (1-72 W DC stripLED/ch.)	3A 24V/ch.	24V DC	95%
	3ch. x (1-72 W DC topLED/ch.)			
99723	1-216 W DC stripLED	9A 24V	24V DC	95%
	1-216 W DC topLEDs			

Adapté à l'alimentation de bandes de LED, LED 5 mm et topLED à tension constante.
 Gradation 0-100 % via bouton NO.
 Chaque driver peut fonctionner en tant que maître ou esclave.
 Possibilité de connecter jusqu'à 20 drivers via le bus Sync.

Bode | DALI 0/1-10V

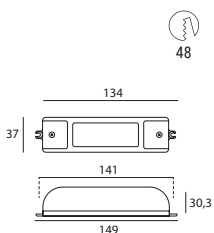

	range	output	input	eff.
99074	3ch. x (1-72 W DC stripLED/ch.)	3A 24V/ch.	24V DC	95%
	3ch. x (1-72 W DC topLED/ch.)			
99660	1-216 W DC stripLED	9A 24V	24V DC	95%
	1-216 W DC topLEDs			

Adapté à l'alimentation de bandes de LED, LED 5 mm et topLED à tension constante.
 Réglage via interface DALI, interface 0/1-10 V ou potentiomètre.

Berda mini | DALI converter

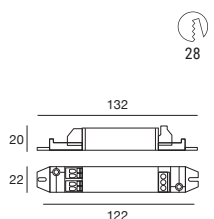
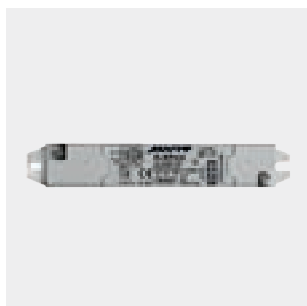

	range	output	input
83041	1-60 W DC stripLED	5A 12V	12V DC
	1-120 W DC stripLED	5A 24V	24V DC

Adapté pour l'alimentation de produits à tension constante de 12/24 V
 Régulation avec interface DALI, PUSH, interface de 1-10 V.

Berda Maxi | DALI converter

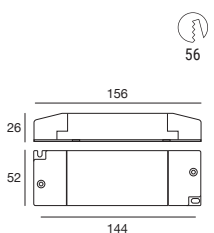
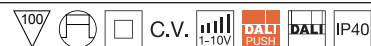

	range	output	input
83042	1-144 W DC stripLED	12A 12V	12V DC
	1-288 W DC stripLED	12A 24V	24V DC

Adapté pour l'alimentation de produits à tension constante de 12/24 V
 Régulation avec interface DALI, PUSH, interface de 0/1-10 V ou avec potentiomètre.

Mini_Penny |On/Off Driver

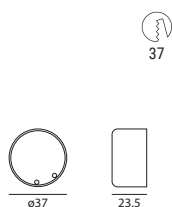
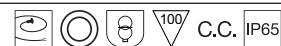

	range	output	input	eff.	PF	surge
89148	1-2 W DC powerLEDs	350mA 6.6V	198~264V AC	80%	0.6 C	0.5 kV
89149	3-6 W DC powerLEDs	350mA 20V	198~264V AC	80%	0.6 C	0.5 kV
89150	3-4.5 W DC powerLEDs	500mA 10V	198~264V AC	80%	0.6 C	0.5 kV
89151	2-4 W DC powerLEDs	630mA 6.6V	198~264V AC	80%	0.6 C	0.5 kV

Protection à réarmement automatique contre la surchauffe, la surcharge, les circuits ouverts et les courts-circuits sur la ligne de sortie.



Mini_Aquaed |On/Off Driver

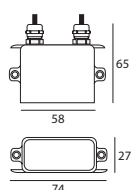

	range	output	input	eff.	PF	surge
89419	1-2 W DC powerLEDs	350mA 6.6V	198~264V AC	80%	0.6 C	0.5 kV
89421	3-6 W DC powerLEDs	350mA 20V	198~264V AC	80%	0.6 C	0.5 kV
89422	1.5-3 W DC powerLEDs	500mA 6.6V	198~264V AC	80%	0.6 C	0.5 kV
89423	3-4.5 W DC powerLEDs	500mA 10V	198~264V AC	80%	0.6 C	0.5 kV
89420	2-4 W DC powerLEDs	630mA 6.6V	198~264V AC	80%	0.6 C	0.5 kV

Protection à réarmement automatique contre la surchauffe, la surcharge, les circuits ouverts et les courts-circuits sur la ligne de sortie.



Penny_Q |On/Off Driver

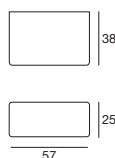

	range	output	input	eff.	PF	surge
99716	7.5 W DC topLED	180mA 40V	198~264V AC	76%	0.6 C	4 kV

Smartwave™ : excellente efficacité, longue durée de vie, protection contre les surtensions, PF élevé. Protection contre la surchauffe, la surcharge, les circuits ouverts et les courts-circuits sur la ligne de sortie.



Penny |On/Off Driver

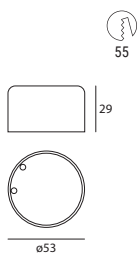
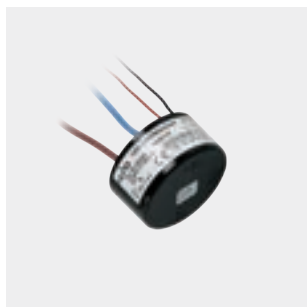
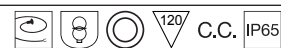

	range	output	input	eff.	PF	surge
99177	6-12 W DC powerLEDs	350mA 39V	198~264V AC	84%	0.96	4 kV
99176	4.5-9 W DC powerLEDs	500mA 20V	198~264V AC	84%	0.96	4 kV
99175	6-12 W DC powerLEDs	630mA 20V	198~264V AC	84%	0.96	4 kV

Smartwave™ : excellente efficacité, longue durée de vie, protection contre les surtensions, PF élevé.
Protection contre la surchauffe, la surcharge, les circuits ouverts et les courts-circuits sur la ligne de sortie.

Aquaed |On/Off Driver

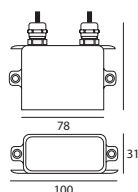

	range	output	input	eff.	PF	surge
99342	3.8-8.4W DC powerLEDs	220mA 39V	198~264V AC	84%	0.6 C	4 kV
99183	13 W DC arrayLED 6-12 W DC powerLEDs	350mA 36V	198~264V AC	84%	0.95	4 kV
99181	4.5-9 W DC powerLEDs	500mA 20V	198~264V AC	80%	0.95	4 kV
99179	6-12 W DC powerLEDs	630mA 20V	198~264V AC	80%	0.95	4 kV

Protection à réarmement automatique contre la surchauffe, la surcharge, les circuits ouverts et les courts-circuits sur la ligne de sortie.

Maxi_Aquaed |On/Off Driver

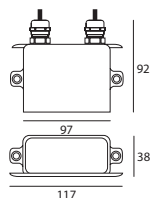

	range	output	input	eff.	PF	surge
99185	20 W DC arrayLED 9-18 W DC powerLEDs	500mA 39V	198~264V AC	91%	0.95	4 kV
99340	20 W DC arrayLED	580mA 37V	198~264V AC	91%	0.95	4 kV
99186	20 W DC arrayLED 12-24 W DC powerLEDs	630mA 39V	198~264V AC	91%	0.95	4 kV
99269	30 W DC arrayLED	840mA 37V	198~264V AC	91%	0.95	4 kV

Smartwave™ : excellente efficacité, longue durée de vie, protection contre les surtensions, PF élevé.
Protection contre la surchauffe, la surcharge, les circuits ouverts et les courts-circuits sur la ligne de sortie.

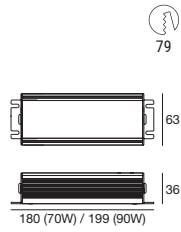

	range	output	input	eff.	PF	surge
99726	70 W DC topLED	1.8A 37V	100~250V AC	93%	0.9	2 kV
99728	90 W DC topLED	2.28A 37V	100~250V AC	93%	0.9	2 kV

Réglages via interface 0/1-10 V ou potentiomètre. Protection à réarmement automatique contre la surchauffe, la surcharge, les circuits ouverts et les courts-circuits sur la ligne de sortie.

98436
Cable and connector

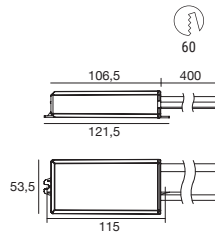
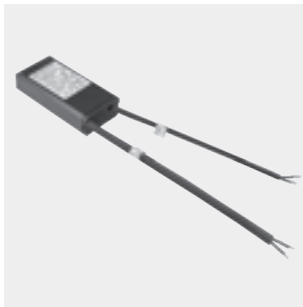

	range	output	input	eff.	PF	surge
83154	4-12W DC powerLEDs	250mA 15-49V	99~264 V AC	>88%	0,95	4kV
83100	1-14W DC powerLEDs	350mA 2-49V	99~264 V AC	>88%	0,95	4kV
83101	1,5-21W DC powerLEDs	500mA 2-49V	99~264 V AC	>88%	0,95	4kV
83102	2-28W DC powerLEDs	630mA 2-49V	99~264 V AC	>88%	0,95	4kV
83103	2,5-30W DC powerLEDs	700mA 2-43V	99~264 V AC	>88%	0,95	4kV

Réglages via interface DALI 2. Protection contre la surchauffe, la surcharge, les circuits ouverts et les courts-circuits sur la ligne de sortie.



99309
Power supply



Mean | DALI Driver

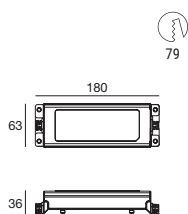

	range	output	input	eff.	PF	surge
83194	54 W DC topLED	1.45A 36V	100~305V AC	89%	0.9	4 kV
83195	75 W DC topLED	2.1A 36V	100~305V AC	89%	0.9	4 kV

Réglages via interface DALI. Protection à réarmement automatique contre la surchauffe, la surcharge, les circuits ouverts et les courts-circuits sur la ligne de sortie.



99309
Power supply

Mean | DALI Driver

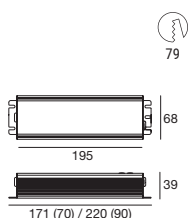

	range	output	input	eff.	PF	surge
99727	70 W DC topLED	1.8A 37V	120~277V AC	93%	0.9	2 kV
99729	90 W DC topLED	2.28A 37V	120~277V AC	93%	0.9	2 kV

Réglages via interface DALI. Protection à réarmement automatique contre la surchauffe, la surcharge, les circuits ouverts et les courts-circuits sur la ligne de sortie.



99309
Power supply

Mean | DALI Driver

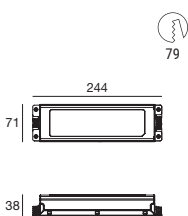

	range	output	input	eff.	PF	surge
83196	157W DC topLED	4.35A 42V	100~305V AC	92%	0.9	6 kV

Réglages via interface DALI. Protection à réarmement automatique contre la surchauffe, la surcharge, les circuits ouverts et les courts-circuits sur la ligne de sortie.



99309
Power supply

Aqualed |On/Off Driver 24V

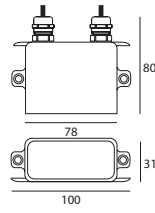

	range	output	input	eff.	PF	surge
89488	1-14.4 W DC stripLED	600mA 24V	190~250V AC	80%	0.6 C	0.5 kV
	1-14.4 W DC topLED					

Adapté à l'alimentation de bandes de LED, LED 5 mm et topLED à tension constante.
Protection à réarmement automatique contre les circuits ouverts et les courts-circuits sur la ligne de sortie.



Lingotto |On/Off Driver 24V

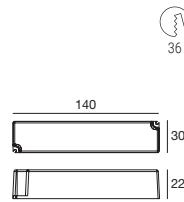
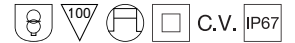

	range	output	input	eff.	PF	surge
83009	1-18 W DC stripLED	750mA 24V	190~250V AC	82%	0.6 C	3 kV
	1-18 W DC topLED					

Adapté à l'alimentation de bandes de LED, LED 5 mm et topLED à tension constante.
Protection à réarmement automatique contre les circuits ouverts et les courts-circuits sur la ligne de sortie.

Maxi_Aqualed |On/Off Driver 24V

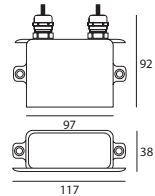

	range	output	input	eff.	PF	surge
89179	1-24 W DC stripLED	1A 24V	198~264V AC	88%	0.6 C	2 kV
	1-24 W DC topLED					

Adapté à l'alimentation de bandes de LED, LED 5 mm et topLED à tension constante.
Protection à réarmement automatique contre les circuits ouverts et les courts-circuits sur la ligne de sortie.



Giant_Aqualed |On/Off Driver 24V

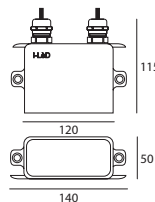

	range	output	input	eff.	PF	surge
89359	1-48 W DC stripLED	2A 24V	198~264V AC	89%	0.6 C	1 kV
	1-48 W DC topLED					

Adapté à l'alimentation de bandes de LED, LED 5 mm et topLED à tension constante.
Protection à réarmement automatique contre les circuits ouverts et les courts-circuits sur la ligne de sortie.

Reson_150 |On/Off Driver 24V

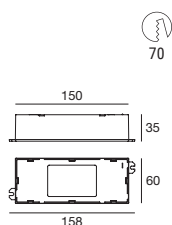

	range	output	input	eff.	PF	surge
99331	1-150 W DC stripLED 1-150 W DC topLED	6.25A 24V	198~264V AC	95%	0.98	5 kV

Adapté à l'alimentation de bandes de LED, LED 5 mm et topLED à tension constante. Protection à réarmement automatique contre les circuits ouverts et les courts-circuits sur la ligne de sortie. Efficacité élevée, longue durée de vie et PF élevé.



Mean |On/Off Driver 24V

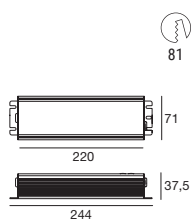

	range	output	input	eff.	PF	surge
99786	1-240 W DC stripLED 1-240 W DC topLED	10A 24V	100~240V AC	92%	0.95	2 kV

Adapté à l'alimentation de bandes de LED, LED 5 mm et top LED à tension constante. Protection à réarmement automatique contre les circuits ouverts et les courts-circuits sur la ligne de sortie.

Mean |On/Off Driver 48V

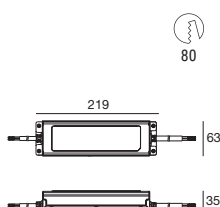
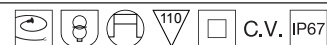

	range	output	input	eff.	PF	surge
99784	1-150 W DC	3.13A 48V	180~295V AC	91%	0.95	2 kV

Adapté pour Real_T, Smart, Pixie. Protection à réarmement automatique contre les circuits ouverts et les courts-circuits sur la ligne de sortie.

Mean |On/Off Driver 48V

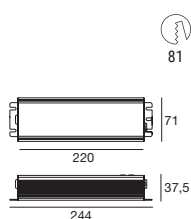
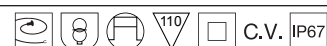

	range	output	input	eff.	PF	surge
99785	1-240 W DC	5A 48V	100~240V AC	92%	0.95	2 kV

Adapté pour Real_T, Smart, Pixie. Protection à réarmement automatique contre les circuits ouverts et les courts-circuits sur la ligne de sortie.

Mean | On/Off Driver 12V

NEW C.V. IP67

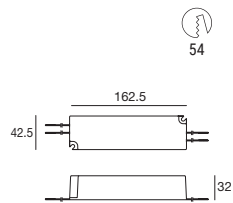

	range	output	input	eff.	PF	surge
83010	1-60W DC	5A 12V	90~264V AC	83%		3 kV

Adapté pour Nautilus, MK68.
Protection à réarmement automatique contre les circuits ouverts et les courts-circuits sur la ligne de sortie.

Mean | On/Off Driver 12V

NEW C.V. IP67

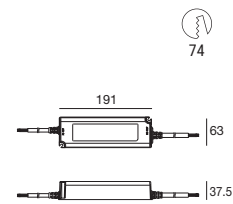

	range	output	input	eff.	PF	surge
83013	1-150W DC	12.5A 12V	180~305V AC	87%		3 kV

Adapté pour Nautilus, MK68.
Protection à réarmement automatique contre les circuits ouverts et les courts-circuits sur la ligne de sortie.



Mean | DALI driver 12V

NEW C.V. IP67

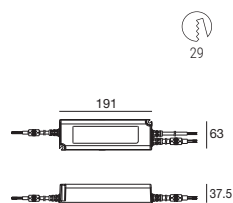

	range	output	input	eff.	PF	surge
83015	120W DC	10A 12V	90~305V AC	88%	0.9	2kV

Réglages via interface DALI. Protection à réarmement automatique contre la surchauffe, la surcharge, les circuits ouverts et les courts-circuits sur la ligne de sortie.

Mean | DALI driver 12V

NEW C.V. IP67

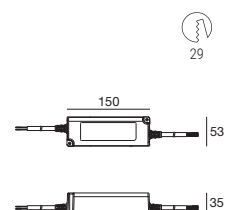

	range	output	input	eff.	PF	surge
83012	60W DC	5A 12V	90~305V AC	86%	0.9	2kV

Réglages via interface DALI. Protection à réarmement automatique contre la surchauffe, la surcharge, les circuits ouverts et les courts-circuits sur la ligne de sortie.

Reson_150 | 0/1-10V Driver 24V



70

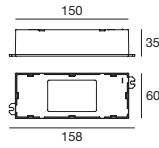

	range	output	input	eff.	PF	surge
99332	1-150 W DC stripLED	6.25A 24V	198~264V AC	95%	0.98	5 kV
	1-150 W DC topLED			95%	0.98	5 kV

Adapté à l'alimentation de bandes de LED, LED 5 mm et topLED à tension constante.
 Protection à réarmement automatique contre les circuits ouverts et les courts-circuits sur la ligne de sortie.
 Efficacité élevée, longue durée de vie et PF élevé.
 Réglage via interface ou potentiomètre 0/1-10 V.



Mean | DALI Driver 24V



73

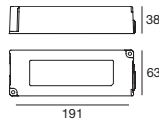

	range	output	input	eff.	PF	surge
99722	1-120 W DC stripLED	5A 24V	190~250V AC	90%	0.9C	2 kV

Réglages via interface DALI. Protection à réarmement automatique contre la surchauffe, la surcharge, les circuits ouverts et les courts-circuits sur la ligne de sortie.

Mean | DALI Driver 24V



81

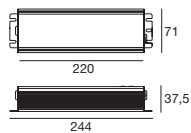

	range	output	input	eff.	PF	surge
99787	1-240 W DC stripLED	10A 24V	180~295V AC	91%	0.95	2 kV
	1-240 W DC topLED					

Adapté à l'alimentation de bandes de LED, LED 5 mm et topLED à tension constante. Réglage via interface DALI. Protection à réarmement automatique contre la surchauffe, la surcharge, les circuits ouverts et les courts-circuits sur la ligne de sortie.

Mean | DALI Driver 48V



80

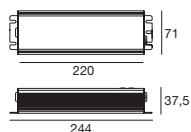

	range	output	input	eff.	PF	surge
83179	1-150W DC	3.13A 48V	180~295V AC	90%	0.95	6 kV

Adapté à l'alimentation de bandes de LED, LED 5 mm et topLED à tension constante. Réglage via interface DALI. Protection à réarmement automatique contre la surchauffe, la surcharge, les circuits ouverts et les courts-circuits sur la ligne de sortie.

Round | On/Off Converter

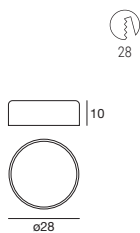
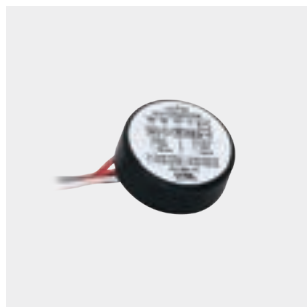

	range	output	input	eff.
89175	1-3 W DC powerLEDs	350mA 12V	12V DC	95%
	1-6 W DC powerLEDs	350mA 24V	24V DC	95%
89176	1.5-4.5 W DC powerLEDs	500mA 12V	12V DC	95%
	1.5-9 W DC powerLEDs	500mA 24V	24V DC	95%
89177	2-6 W DC powerLEDs	630mA 12V	12V DC	95%
	2-12 W DC powerLEDs	630mA 24V	24V DC	95%

Protection contre la surchauffe, la surcharge, les circuits ouverts et les courts-circuits sur la ligne de sortie.

Smart | RF remote

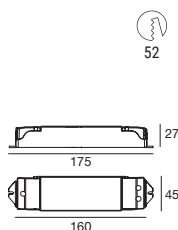

	range	output	input	eff.
99703	4ch. x (0.6-8.4 W powerLEDs/ch.)	220mA 39V	48V DC	95%
	4ch. x (0,6-4,2 W powerLEDs/ch.)	220mA 20V	24V DC	
99741	4ch. x (1-12 W powerLEDs/ch.)	350mA 39V	48V DC	95%
	4ch. x (1-6 W powerLEDs/ch.)	350mA 20V	24V DC	
99742	4ch. x (1.5-18 W powerLEDs/ch.)	500mA 39V	48V DC	95%
	4ch. x (1.5-9 W powerLEDs/ch.)	500mA 20V	24V DC	
99743	4ch. x (2-24 W powerLEDs/ch.)	630mA 39V	48V DC	95%
	4ch. x (2-12 W powerLEDs/ch.)	630mA 20V	24V DC	

48V DC switching

99784	Exa 150 W IP65
--------------	----------------

24V DC switching

99371	Peta 50 W
84700	Peta 75 W
99374	Reason 75 W



99700
RF Remote
Full MONO



99701
RF Remote
Full DYNAMIC



99702
RF Remote
Full RGB/RGBW

Gradation via télécommande à fréquence radio ou simple bouton NO.
Synchronisation de 20 éléments avec une seule télécommande. Appareil avec 4 canaux et commutateur DIP dédié pour les configurations : MONO, DYNAMIC, RGB, RGBW.
Protection contre la surchauffe, la surcharge, les circuits ouverts et les courts-circuits sur la ligne de sortie.

Fonctions de télécommande RF FULL :

- on/off
- gradation
- rappel de maximum 4 scènes

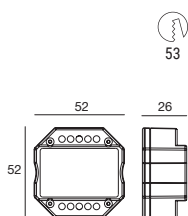

	range	output	input	eff.
99694	MONO stripLED	3A x 4ch. 24V	24V DC	95%
99695	DYNAMIC stripLED	3A x 4ch. 24V	24V DC	95%
99696	RGB/RGBW stripLED	3A x 4ch. 24V	24V DC	95%
99540	Repeater	5A x 4ch. 24V	24V DC	95%

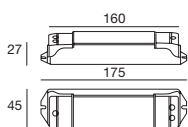

24V DC switching		24V DC switching	
99371	Peta 50 W	99331	Reason 150 W
84700	Peta 75 W	99786	Mean 240 W
99374	Reason 75 W		

Gradation via télécommande à fréquence radio ou simple bouton NO.
Synchronisation de 20 éléments avec une seule télécommande. Appareil avec 4 canaux et commutateur pour les configurations : MONO, DYNAMIC, RGB, RGBW.
Protection contre la surchauffe, la surcharge, les circuits ouverts et les courts-circuits sur la ligne de sortie.

Fonctions de télécommande RF FULL :

- on/off
- gradation
- rappel de maximum 4 scènes

FR Remote



99700
RF Remote
Full MONO



99701
RF Remote
Full DYNAMIC



99702
RF Remote
Full RGB/RGBW

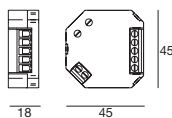

	comand	output	connector	input
KIT0027	Push DIM	350W	CLAMP	220~240V AC

Gradateur à coupure de phase, via bouton NO.
Sélecteurs rotatifs pour le choix de la gradation et des temps de montée et de descente.
Configuration AUTO qui permet la gradation de tout type de lampe à 230 VAC.

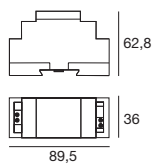

	type	signal output	connector	input
99310	White	DALI 15~16V DC	CLAMP	220~240V AC

Alimentation pour BUS DALI de 240 mA, pour appareils DALI ou modules de contrôle sans alimentation propre.

Alimentation adaptée au montage sur rail DIN Omega 35 mm.

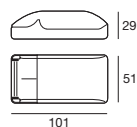

	type	signal output	connector	input
99309	Transp.	DALI 15~16V DC	CLAMP	220~240V AC

Alimentation pour BUS DALI de 200 mA, pour appareils DALI ou modules de contrôle sans alimentation propre.

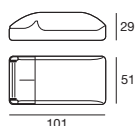

	type	signal output	connector	input
99308	Transp.	DALI	CLAMP USB	4.5~5V DC

Interface PC/DALI.
Elle permet de connecter le PC au système DALI pour effectuer l'adressage de chaque driver et gérer les scénarios et les groupes.
Le système doit être complété du logiciel gratuit « MasterCONFIGURATOR ». Alimentation via câble DALI et interface USB



99309
Power supply

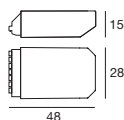

	type	signal output	connector	input
99311	White	DALI	CLAMP	15~16V DC

4 entrées indépendantes pour contacts/boutons NO.
Mode de fonctionnement réglable via 2 sélecteurs rotatifs.
Possibilité de connecter plusieurs DALI XC sur la ligne DALI.
Alimentation via câble DALI.
Câbles de connexion (longueur 25 cm, de couleurs correspondant aux bornes) inclus.



99309
Power supply

UPB4 | DALI

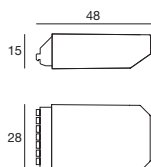

	type	signal output	connector	input
83147	White	DALI	CLAMP	15~16V AC

4 entrées indépendantes pour contacts et boutons N / O.
Possibilité de connecter plusieurs UPB4 sur la ligne DALI.
Alimentation via câble DALI.
Câbles de connexion d'une longueur de 25cm selon les couleurs du terminal.

SceneCOM | DALI

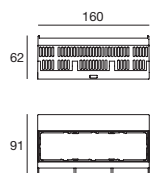

	type	signal output	connector	input
83146	White	3 DALI Lines	CLAMP	220~240V AC

Unité de contrôle DALI.
Nombre maximum de pilotes DALI pouvant être connectés 192.
3 sorties DALI.
Interface Web pour la programmation. Horaires et fonctions de calendrier programmables

Pannel DALI | x/e-touch PANEL

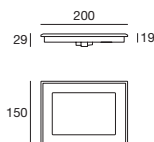

	type	signal output	connector	Input
99305	Grey	2 Uni DALI	Clamp RJ45 USB	220~240 VDC



99309
Power Supply



99310
Power Supply

Écran tactile couleur (7 ").
Logiciel d'application facile à utiliser «MasterCONFIGURATOR».
Avec les fonctions système DALI d'adressage et de regroupement.
Interface USB et Ethernet.
Il peut être contrôlé à distance via un navigateur web ou le logiciel em-LINK
Système de gestion de la lumière avec jusqu'à 128 DALI.

basicDIM DGC | Digital controller

IP20

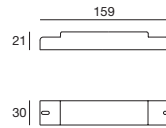

	type	signal output	connector	input
83115	White	DALI/DSI	CLAMP	220~240V AC

2 sorties de contrôle de broadcast pour 10 + 10 pilotes DALI \ DSI.
Possibilité de programmation via le programmeur TLC FULL 83118 ou via le logiciel gratuit "MasterCONFIGURATOR"

basicDIM DGC | Sensor 5DPI 14rc

IP20

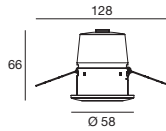

	type	signal output	connector	input
83116	White	DALI/DSI	CLAMP	220~240V AC

Capteur LUX \ PIR, maximum 4 capteurs connectés à un contrôleur 83115.
Possibilité de programmation via le programmeur TLC FULL 83118 ou via le logiciel gratuit "MasterCONFIGURATOR"

basicDIM DGC | Full Programmer

IP20

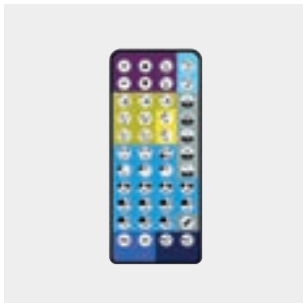

	L x W x H
83118	130x56x15

Télécommande de programmation pour 83115 et 83116.
Fonctions de programmation: niveaux de luminosité et temps de retard pour l'allumage et l'extinction, possibilité de désactiver LUX ou \ et capteur PIR.

basicDIM DGC | Easy Programmer

IP20



	L x W x H
83119	86.5x40.5x72

Télécommande pour la gestion des 83115 et 83116.
Fonctionnalité d'activation, de désactivation et de gradation.
Activation de la commande d'éclairage automatique (LUX).

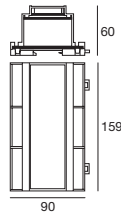

	range	output	input	eff.		
99333	4ch. x (0.6-8.4 W powerLEDs/ch.)	220mA 39V	48V DC	95%		
	4ch. x (1-12 W powerLEDs/ch.)	350mA 39V				
	4ch. x (15 W arrayLED/ch.)	400mA 37V				
	4ch. x (1.5-18 W powerLEDs/ch.)	500mA 39V				
	4ch. x (2-24 W powerLEDs/ch.)	630mA 39V				
	4ch. x (25 W arrayLED/ch.)	700mA 37V				
	4ch. x (30 W arrayLED/ch.)	840mA 37V				
	4ch. x (35 W arrayLED/ch.)	950mA 37V				
	4ch. x (0,6-4,2 W powerLEDs/ch.)	220mA 20V			24V DC	95%
	4ch. x (1-6 W powerLEDs/ch.)	350mA 20V				
4ch. x (1.5-9 W powerLEDs/ch.)	500mA 20V					
4ch. x (2-12 W powerLEDs/ch.)	630mA 20V					

code	48V DC switching	code	24V DC switching
99784	Mean 150 W IP65	99371	Peta 50 W
		84700	Peta 75 W
		99374	Reason 75 W
		99331	Reason 150 W IP65

Compatible avec le protocole USITT DMX 512-A.
 Adressage DMX via interface à boutons : CH1 - CH512.
 Possibilité de régler le courant de sortie de 220 mA à 1 A, via interface à boutons.
 Affichage du courant et de l'adresse DMX sur afficheur.
 Modification en temps réel des paramètres, de l'adresse DMX et du courant. Possibilité de gérer 3 ou 4 adresses/canaux DMX (RGB - RGBW - WRGB) via cavalier.
 Appareil adapté au montage sur rail DIN Omega 35 mm.



84865
Câble DMX

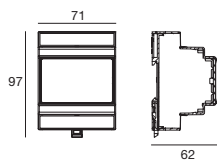

	range	output	input
83187	4ch 3/37W	250mA 700mA	12/24/48V DC
		12/24/48V DC	

Convient pour alimenter les produits Nautilus RGBW.
 Régulation via interface DMX, PUSH, interface 0 / 1-10V et potentiomètre.
 Quatre canaux de sortie. Fonctions de gradation accord chaud, blanc dynamique, RVB, RGBW. Adresse courant et dmx réglables via le commutateur rotatif ou via DMX \ RDM.



84865
Cable

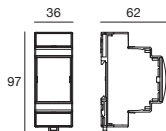

	range	output	input	eff.
83177	1-78 W DC	8A 12V	12V DC	95%
	1-156 W DC	8A 24V	24V DC	95%
	1-312 W DC	8A 48V	48V DC	95%

Convient pour alimenter des produits à tension constante 12/24 / 48V.
Régulation via interface DMX, PUSH, interface 0 / 1-10V ou potentiomètre. Canal de sortie unique.



84865
Cable

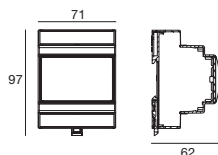

	range	output	input	eff.
83178	4ch (1-60W DC/ch)	5A 12V/ch	12V DC	95%
	4ch (1-120W DC/ch)	5A 24V/ch	24V DC	95%
	4ch (1-240W DC/ch)	5A 48V/ch	48V DC	95%

Convient pour alimenter des produits à tension constante 12/24 / 48V.
Régulation via interface DMX, PUSH, interface 0 / 1-10V.
Quatre canaux de sortie. Fonctions de réglage chaud, blanc dynamique, RVB, RGBW.



84865
Cable

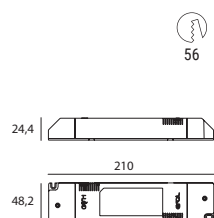

	range	output	input	eff.
99278	4ch. x (1-72 W stripLED/ch.)	3A 24V/ch	24V DC	95%
	4ch. x (1-72 W topLED/ch.)			

Adapté à l'alimentation de bandes de LED et LED 5 mm, y compris RGB.
Adresse DMX sélectionnable via 3 sélecteurs rotatifs.
Compatible avec le protocole USITT DMX 512-A.
256 appareils maximum peuvent être installés sur le même bus DMX.
Adressage DMX : CH1 - CH512. Longueur maximale de la ligne DMX : 300 m.
Possibilité de gérer 3 ou 4 adresses/canaux DMX (RGB - RGBW - WRGB) via cavalier.



84865
Cable



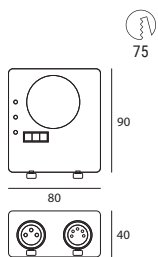

	signal output	connector	input
99050	DMX	RJ45 XLR 3 Pin F. XLR 5 Pin F. mini USB	5.5~6V DC

Passage de 1 à 49 pages différentes.
 Sélecteur de 5 zones.
 Afficheur graphique du mode de fonctionnement.
 Fonction « live » via USB.
 Compatible avec l'application à distance qui permet de créer une interface personnalisée et d'envoyer toute commande de l'unité de contrôle.



89186
 5 m extension M 5 pin M12
 M 3 pin XLR

98493
 5 m extension M 5 pin M12
 M 5 pin XLR



84869
 Connector
 M 3 pin XLR



99346
 Connector
 M 5 pin XLR



84865
 DMX cable

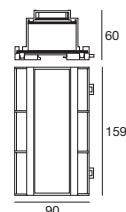

	signal output	connector	input
83144	6 uni DMX/RDM	CLAMP Ethernet RJ45 USB typeC	12V DC

Unité de contrôle DMX\RDM, contrôle jusqu'à 6 univers DMX, possibilité de gérer la scénographie par contacts. Gestion des relais de puissance. Application disponible pour le contrôle à distance



83145
 Power Supply

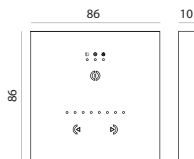
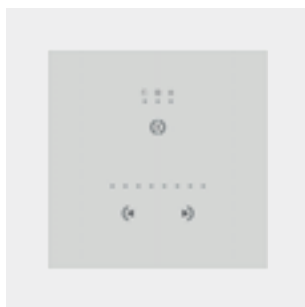

	type	signal output	connector	input
99045	White	DMX	CLAMP micro USB	5.5~6V DC
99046	Black	DMX	CLAMP micro USB	5.5~6V DC

Sélecteur de mode : Couleur, Scénario et Gradateur.
 En mode scénario, il est possible de rappeler une série de valeurs définies.
 Pendant l'exécution d'un programme, la fonction gradation permet de faire varier l'intensité.
 En mode couleur, il est possible de rappeler une série de couleurs statiques prédéfinies.
 Toutes les fonctions peuvent être configurées depuis le gestionnaire matériel (activation/désactivation des différents modes, sélection du scénario de départ, etc.).



- 
99184
 Power supply
- 
84865
 DMX cable
- 
98140
 Outer casing

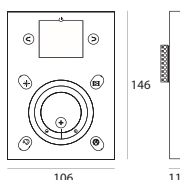

	type	signal output	connector	input
99234	White	DMX	CLAMP RJ45 mini USB	5.5~6V DC
99235	Black	DMX	CLAMP RJ45 mini USB	5.5~6V DC

Sélecteur de zone pour activer jusqu'à 10 scénarios simultanément.
 Gradateur pour le réglage de l'intensité lumineuse et de la saturation.
 Sélecteur permettant de choisir jusqu'à 50 scénarios et entre scénario dynamique et statique. Les flèches permettent de changer de scénario.
 Sélecteur permettant de choisir parmi 16 millions de couleurs. Les flèches permettent de sélectionner les valeurs RGB.
 Possibilité de faire varier la vitesse des scénarios dynamiques et des effets de couleur.



- 
99184
 Power supply
- 
84865
 DMX cable
- 
98140
 Outer casing

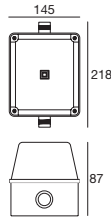

	signal output	signal input	connector	Power input
99387	Pixie cable	DMX512/RDM	5 Pin F.	48 V DC

Nécessaire pour piloter Pixies PIXEL.
Programmable via RDM. Isole galvaniquement la ligne Pixie PIXEL de la ligne DMX/RDM pour éviter la propagation de perturbations.



98493
5 m extension
M 5 pin M12
M 5 pin XLR



89187
M. / F.
5pin M12



83199
M. / F. 4 pin



84865
DMX cable



99785
48V



89365
DMX Line
closure

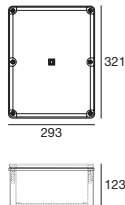

	signal output	signal input	connector	Power input
99388	4 Paseo cable	DMX512/RDM ETHERNET (Artnet, sACN)	5 Pin M12	100~240 V AC

Nécessaire pour piloter Paseo_PIXEL en mode haute densité de pixels.
Pont RDM pour la programmation des Paseo_PIXEL.
Prend en charge 16 univers DMX via protocole ARTNET ou sACN.
Génère le signal RS-485 nécessaire aux Paseo_PIXEL.



98493
5 m extension
M 5 pin M12
M 5 pin XLR



99346
Connector
M 5 pin XLR



84865
DMX cable

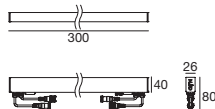

	type	signal output	signal input	connector	Power input
83193	Black	DMX 2048	DMX 512 / RDM	CLAMP	24 - 48V DC

Interface de contrôle non isolée pour article rgb / rgbw avec contrôle numérique.
Recommandé pour les éclips Paseo ou pour les articles Linea Light uniquement.
Distance maximale du nœud ArtNet 50 mètres.
Contrôle via l'adresseur DMX / RDM 99385.

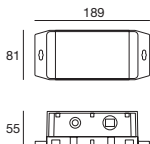

	signal output	connector	Input
99575	16 Uni ArtNet	RJ45	12~40 V DC
99576	32 Uni ArtNet	RJ45	12~40 V DC
99577	64 Uni ArtNet	RJ45	12~40 V DC

Enregistreur autonome ArtNet DMX des séquences ArtNet DMX.
Il est accessible à partir d'un appareil mobile ou d'un navigateur Web pour régler les paramètres d'enregistrement et de déclenchement.

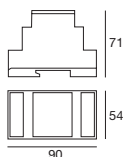

	signal output	signal input	connector	Power input
83192	2 x DMX-RDM	ETHERNET (Artnet4 protocol)	CLAMP RJ45	12 ~ 24 V DC

Convertisseur de signaux ArtNet vers DMX RDM.
Possibilité de configuration par le biais d'une page web.

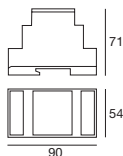

	signal output	signal input	connector	Power input
99657	Bus DMX512	Bus DMX512	Clamp	12V DC



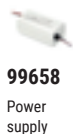

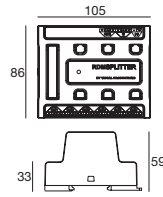
L'isolateur de ligne isole galvaniquement l'entrée DMX512/RDM et la sortie.
Il est possible, via RDM, de définir le comportement et donc le type de fonctionnement.





	signal output	signal input	connector input
99386	6 DMX512/RDM	DMX512/RDM	CLAMP 9~24V DC



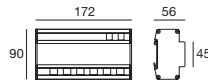

Le répartiteur DMX-512 reçoit le signal DMX en entrée et le renvoie aux 6 ports de sortie DMX. Le répartiteur peut également servir d'amplificateur de signal dans la mesure où chaque port prend en charge une autre connexion de 300 m de long. Ce répartiteur est conforme au protocole RDM pour la communication bidirectionnelle sur DMX. Appareil adapté au montage sur rail DIN Omega 35 mm.

- 
99658
 Power supply
- 
84865
 DMX cable
- 
89189
 5m cable M 5 pin M12
- 
98985
 ALLinONE splitter signal/power



	signal output	signal input	connector Input
83148	6 DMX 512 / RDM	DMX 512 / RDM	Clamp 10~48 VDC

Le répartiteur DMX-512 reçoit le signal DMX en entrée et le renvoie aux 6 ports de sortie DMX. Le répartiteur peut également servir d'amplificateur de signal dans la mesure où chaque port prend en charge une autre connexion de 300 m de long. Ce répartiteur est conforme au protocole RDM pour la communication bidirectionnelle sur DMX. Appareil adapté au montage sur rail DIN Omega 35 mm.

- 
99658
 Power supply
- 
84865
 DMX cable
- 
89189
 5m cable M 5 pin M12
- 
98985
 ALLinONE splitter signal/power

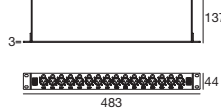

	signal output	signal input	connector	Power input
99381	2 DMX512	Ethernet RJ45	XLR 5 Pin F.	100~240V AC
99382	4 DMX512	Ethernet RJ45	XLR 5 Pin F.	100~240V AC
99383	8 DMX512	Ethernet RJ45	XLR 5 Pin F.	100~240V AC
99384	16 DMX512	Ethernet RJ45	XLR 5 Pin F.	100~240V AC

Reçoit via Ethernet le protocole ArtNet. Génère le signal DMX512. Synchronisation parfaite entre les univers. Configurable via page web.

- 
98493
 5 m extension M 5 pin M12
- 
99346
 Connector M 5 pin XLR
- 
84865
 DMX cable
- 
89189
 5m cable M 5 pin M12

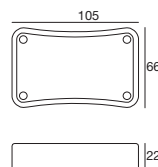

	signal output	signal input	connector	Power input
99385	2 DMX512	USBtypeMicro-B	XLR 5 Pin F.	USB 5V

Logiciel ENTTEC inclus. Nécessaire pour programmer des appareils DMX/RDM. Tester le bon fonctionnement du système. Il est possible d'utiliser les deux univers DMX et le mode autonome pour les mises en scène sur les petites installations (1024 pixels).

- 
89186
 5 m extension M 5 pin M12 M 3 pin XLR
- 
98493
 5 m extension M 5 pin M12 M 5 pin XLR
- 
99346
 Connector M 5 pin XLR
- 
84865
 DMX cable
- 
89189
 5m cable M 5 pin M12

DMXnode | ArtNet converter

NEW   IP20



	signal output	signal Input	Connector	Power Input
83149	4 UNI	ArtNet	RJ45 XLR3	100~240V AC
83150	4 UNI	ArtNet	RJ45 XLR3	
83151	8 UNI	ArtNet	RJ45 XLR3	

83152
 Plug Power DMXnode

Convertisseur Art-Net et sACN vers DMX pour 4 et 8 univers indépendants. 4 et 8 ports DMX isolés optiquement individuellement. Affichage graphique et bouton d'encodeur pour une configuration facile et des informations d'état précises. Interface Web pour l'observation de l'état, l'ajustement des paramètres et les mises à jour du micrologiciel. Entrée et sortie Neutrik powerCON

Key | Madrix 5



	type	signal output
81828	entry	8 DMX Universe
81829	basic	32 DMX Universe
81830	professional	128 DMX Universe
81831	ultimate	512 DMX Universe

Licence pour le logiciel Madrix, pour l'activation du signal ArtNet en sortie. Le logiciel MADRIX®5 est l'outil d'illumination préféré des professionnels du secteur, concepteurs d'éclairage.

WS | WorkStation HP

NEW  IP20



	Power input
81835	100~240 vAC

MHD | Monitor

NEW  IP20



			Power input
81836	24 pollici	HDMI	100~240 vAC

HPE | Ethernet Switch

NEW  IP20



	signal output	Power input
99578	8 RJ45	100~240 vAC
99579	24 RJ45	100~240 vAC

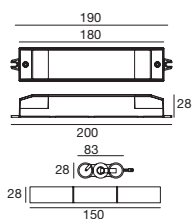

Commutable (on/off) en présence de tension de secteur via interrupteur sur l'entrée SL (ligne commutée). Réinitialisation automatique après remplacement de la batterie et/ou de la lampe LED. Système électronique de charge multi-niveau.
Fourni avec batterie 3000 mAh.

	range	output	input	eff.	PF	surge
99355	Universal	6-60V 40-400mA	220~240V AC	86%	0.5	4 kV

Frequency	50-60 Hz
Nominal input current	40 mA (30 A inrush current with cold start)
Outout voltage (without load)	6-60V
TA Operating temperature	-25 +50 °C
Max casing temperature TC	70 °C
Control interface	Switch Line, Rest mode

Protections	Overtemperature, overload, overvoltage, short-circuit, open circuit
Charge current	200 mA
Emergency output current	400-40 mA
Emergency power	2,4W
Emergency output current	20 h

Reference norms
IEC 61347-2-7:2011, IEC 61347-2-7:2011/AMD1:2017, IEC 61347-1:2015, IEC 61347-1:2015/AMD1:2017, EN 61347-1:2015, EN 61347-2-7:2012+A1:2019, EN 55015:2013/A1:2015, EN61547:2009, EN 61000-3-2: 2014, EN 61000-3-3: 2013

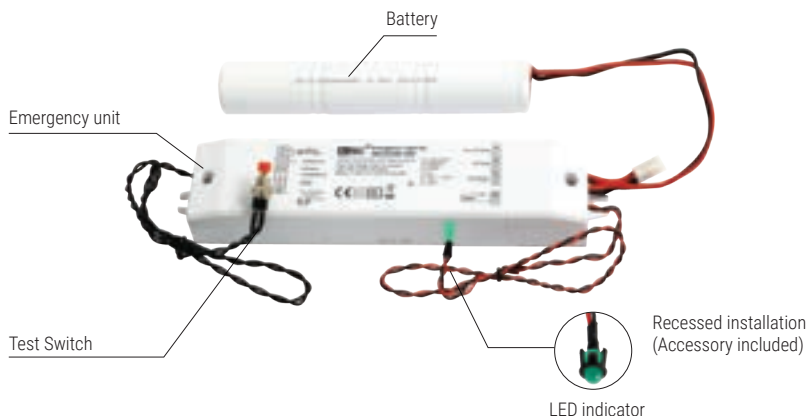

Unswitch Switch

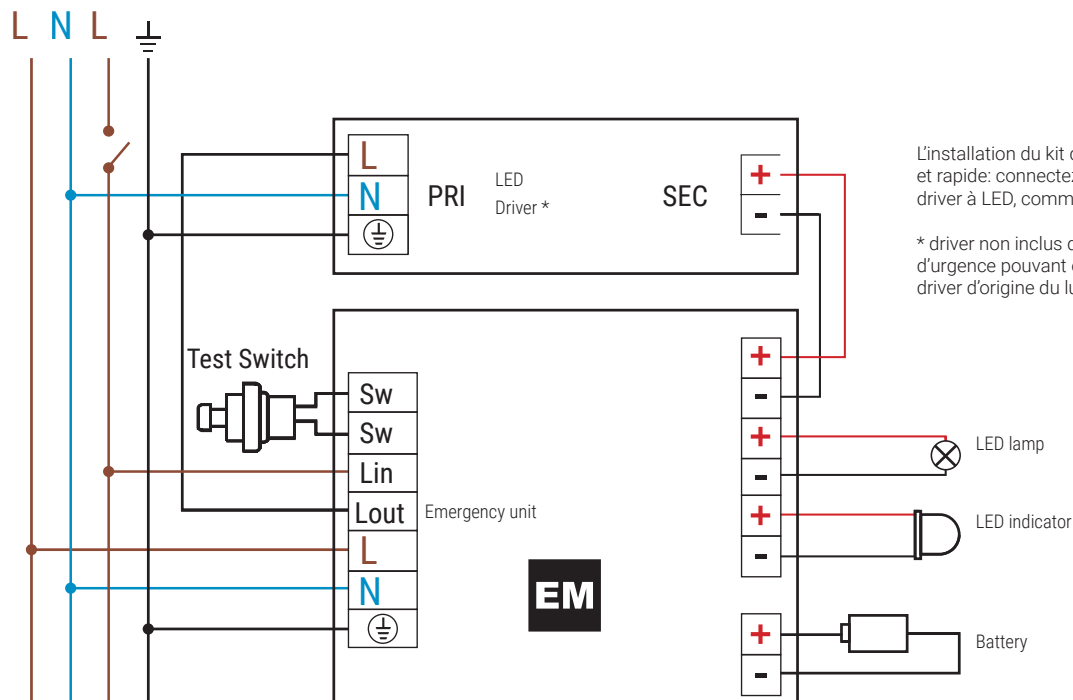

L'installation du kit d'urgence est simple et rapide: connectez l'unité de secours au driver à LED, comme indiqué sur le schéma.

* driver non inclus dans le kit d'urgence / kit d'urgence pouvant être connecté à tous les driver d'origine du luminaire à LED.

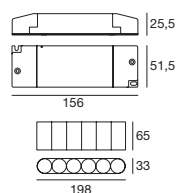

- Fonctionne uniquement en cas d'urgence
- Fonctionne en éclairage continu avec des alimentations électroniques, et électroniques avec gradateur.
- Version réglable avec commutateur DIP, pour alimentation à LED à courant constant ou pour modules LED à tension constante.
- Raccordables à des alimentations avec tension et courant maximaux en sortie de 90 V et 2 A
- Relais instantané en cas de coupure de réseau
- Batterie au NiCd haute température
- Indicateur de charge à LED avec câble FROR
- Dispositif de protection contre les décharges prolongées.
- Possibilités d'autodiagnostic avec le module externe MAT4 DALI.
- Dispositif de recharge avec isolation principale en mesure de recharger la batterie en mode normal, après l'épreuve mentionnée au point 22.3 de la norme CEI EN 61347-2-7:2007
- Fourni avec batterie 3000 mAh.

	range	output	input	PF
KIT0014	Universal C.C.	9-57V 350-60mA	220~240V AC	0.5
	Universal C.V.	24V 2000mA		

Frequency	50-60 Hz
Nominal input current	20 mA
Outout voltage (without load)	9-57V C.C. / 24V C.V.
TA Operating temperature	0 +50 °C
Max casing temperature TC	70 °C
Control interface	Switch Line, Rest mode

Protections	Overtemperature, overload, overvoltage, short-circuit, open circus
Emergency output current	350-60 mA C.C. / 2000mA C.V.
Emergency power	3,4W
Recharging time	24 h

Reference norms	EN61347-2-13, EN61347-2-7, EN61547, EN55015, EN60598-2-22, EN61000-3-2
-----------------	--

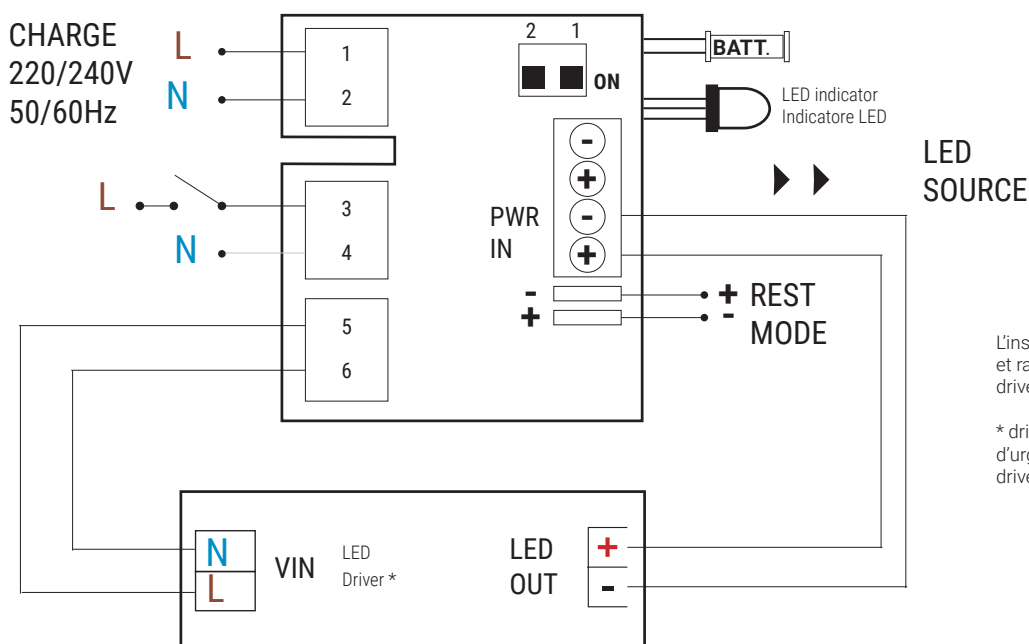

L'installation du kit d'urgence est simple et rapide: connectez l'unité de secours au driver à LED, comme indiqué sur le schéma.

* driver non inclus dans le kit d'urgence / kit d'urgence pouvant être connecté à tous les driver d'origine du luminaire à LED.

cables

application	type	voltage	insulation	Ø	nomenclature	sec. mm	cable colour	core colour	cable gland	temperature	
indoor	--	high	FEP + PVC	5,4 mm	--	3 x 0,75	○	○○○	--	90°C	99348
indoor	--	high	PE	6,6 mm	--	2 x 1	○	●●	PG7	--	99349
indoor	--	high	FEP + PVC	4,2 mm	--	2 x 0,5	○	○○	--	90°C	99350
indoor	RGB	low	PVC + PVC	7 mm	--	6 x 0,75	●	○●●●●●	PG7	--	84874
outdoor	MONO	low	FEP + PCP	5,3 mm	--	2 x 0,5	●	●●	--	70-90°C	99237
outdoor	MONO	low	GUM	6,5 mm	--	2 x 1	●	●●	PG7	--	84888
outdoor	MONO	low	GUM + PCP	8,3 mm	H07RN8-F	2 x 1	●	●●	PG9	60-90°C	84875
outdoor	MONO	low	PVC + PVC	4 mm	--	2 x 0,35	●	●●	--	90°C	99351
outdoor	MONO	low	FEP + PCP	5,8 mm	--	4 x 0,5	●	●●●●	--	70-90°C	99352
indoor out-door	MONO	low	FEP + FEP	1,9 x 3,3 mm	--	2 x 0,5	●●	●●	--	180°C	84892
outdoor	--	high	GUM + PCP	6,2 mm	H05RN-F	2 x 0,75	●	●●	PG7	60-90°C	99353
outdoor	--	high	GUM + PCP	6,5 mm	H05RN-F	2 x 1	●	●●	PG7	60-90°C	99229
outdoor	--	high	GUM + PCP	7,2 mm	H05RN-F	3 x 1	●	●●●	PG7	60-90°C	84887
outdoor	--	high	GUM + PCP	8,7 mm	H07RN-F	3 x 1	●	●●●	PG9	60-90°C	84863
outdoor underwater	MONO	low	NEOPRENE	5,3 mm	--	2 x 0,5	●	●●	--	70-90°C	99002
outdoor underwater	MONO	low	NEOPRENE	6,5 mm	--	3 x 1	●	●●●	PG9	--	84876
outdoor underwater	RGB	low	NEOPRENE	9,6 mm	--	7 x 1	●	○●●●●●●	PG9	--	84864

Extension cables

Les câbles conducteurs à utiliser pour installer nos produits à l'extérieur doivent être du type Néoprène H07 qui répond aux exigences de la norme EN60598 sect. 5.2.2 :

- température d'utilisation 90°C
- type de conducteur cuivre rouge
- tension de fonctionnement 450/750V
- nomenclature H07RN-F
- conforme à la norme CEI 20-19
- conforme aux exigences requises par les directives B.T.73/23CEE et 93/68CEE

Le câble est adapté pour utilisation en milieux tant humides que secs et en plein air ; il est résistant à l'eau, aux abrasions et aux fléchissements fréquents.

Le câble résiste à des températures jusqu'à -25°C sans présenter de fissures superficielles ; il faut néanmoins le protéger s'il se trouve sur une surface exposée au passage de véhicules ou de personnes et éviter des courbures de plus de 30°.

application	voltage	insulation	sec. mm	colour	temperature	
-------------	---------	------------	---------	--------	-------------	--

indoor	low	PVC	3 x 0,5	●●●	90°C	84866
indoor	low	PVC	3 x 0,5	●●●	90°C	84867
indoor	low	PVC	3 x 0,5	●●●	90°C	84872
indoor	low	PVC	3 x 0,5	●○●	90°C	84873

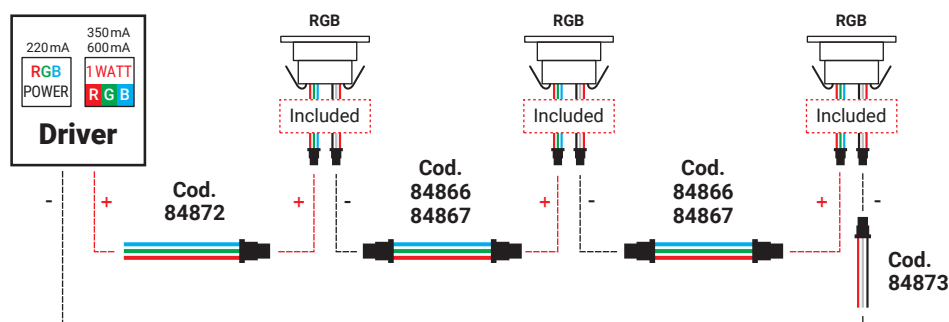

junction boxes | DMX accessories

Junction box | connector gel 2 ways

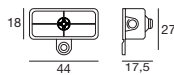

connectors	External Ø of the cable	
IP68 2x0,75 mm ²	Ø 4,8 ~ Ø 6 mm	98989

Junction box | connector 2 ways

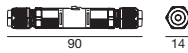

connectors	External Ø of the cable	
IP68 min. 2x0,25 mm ² max. 2x1,0 mm ²	Ø 3 ~ Ø 8 mm	98990

Junction box | connector gel 2 ways

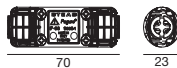

connectors	External Ø of the cable	
IP68 max. 3x1.5 mm ²	Ø 5,5 ~ Ø 10 mm	98991

Junction box | connector 2 ways



connectors	External Ø of the cable	
IP68 min. 2x0,5 mm ² max. 2x2.5 mm ²	Ø 7 ~ Ø 13,5 mm	84893

Junction box | connector gel 4 ways

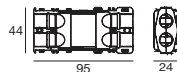

connectors	External Ø of the cable	
IP68 max. 4x1,5 mm ²	Ø 6,5 ~ Ø 12 mm	84894

Cables | DMX



connectors	sec. Ø	L m	
F 3 pin XLR	2 x 0,25 mm ² + shield	1	84895
		5	84994

Extension cables | DMX



connectors	sec. Ø	L m	
M + F 3 pin XLR	2 x 0,25 mm ² + shield	1	84871
		5	84885

Connectors | DMX



connectors	sec. Ø	L m	
XLR		3 M	84869
		3 F	84870
		5 M	99346
		5 F	99379

.....	GND	1
—	B	2
—	A	3



84869



84865



84870

Ø 21,5 mm

.....	GND	1
—	B	2
—	A	3
—		4
—		5



99346



84865



99379

Ø 21,5 mm

DMX accessories

Cable | DMX



price / m

sec. Ø

order: x m / 84865

2 x 0,25 mm² + shield

84865

Connector | DMX line closure adapter



suitable for

input

output

- *Paseo RGBW
- *Paseo_PIXEL RGB
- *Xenia 2.0 RGBW
- *Pixie_PIXEL_box

Bus DMX 512

120 Ohm

89365

Connector | ALLinONE DMX line closure adapter



suitable for

input

output

- *Archiline RGBW
- *Prolamp RGBW

Bus DMX 512

120 Ohm

98986

Connector splitter | ALLinONE splitter power/DMX

Start splitter suitable for

Archiline RGBW
Prolamp RGBW

input

- ① 3x1,5 mm² (for power supply)
- ② 2x0,25 mm² (for DMX) +shield

output

- ③ ALLinONE F
3 x 1,5 mm² +
2 x 0,2 mm² +shield

98985

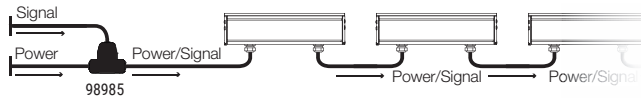

Continuity splitter A suitable for

Archiline RGBW
Prolamp RGBW

input

- ① ALLinONE M
3x1,5 mm² + 2x0,2 mm² +shiel
- ② 3x1,5 mm² (for power supply)

output

- ③ ALLinONE F
3 x 1,5 mm² +
2 x 0,2 mm² +shield

99390

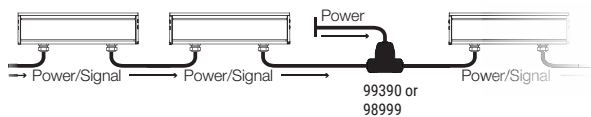
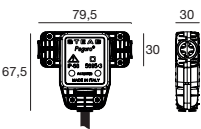

credits



Blue Waters Island
Dubai (UAE)
Project:
Lighting Design: Neolight
Photography:
Neolight



Damac Tower
Dubai (UAE)
Project KEO:
Lighting Concept: DPA
Lighting Consultants:
Oxford
Photography:
Linea Light Group



Museum des Arts Decoratifs
Paris (France)
Project:
Arch. Emmanuel Clair
Photography:
Nicolas Cardin



Vida Residence
Dubai (UAE)
Project:
Lighting Design: Neolight
Photography:
Neolight

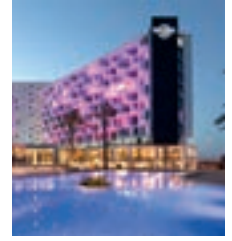

Hard Rock Caffe
Ibiza (Spain)
Project:
Palladium Hotel Group

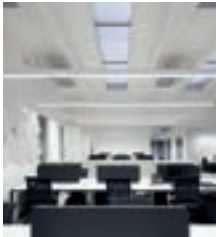

NGC HQ
Como (Italy)
Project:
Arch. Giuseppe Tortato
Architetti Firm
Photography:
Carola Merello



Timinis Store
Limassol (Cyprus)

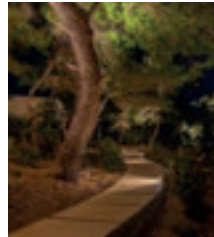

Four Season Hotel
Athens (Greece)
Project:
Lighting design: L+DG
Lighting Architects
Photography: Gavriilux
Papadiotis



Zeche Zollverein
Essen (Germany)
Project:
Lighting Design: Engineer
Büro Paulus Essen, Herr
Gräf
Photography:
Linea Light GmbH

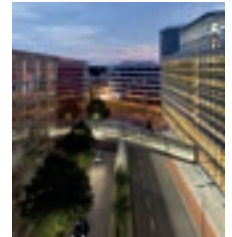

Capricorn Bridge
Dusseldorf (Germany)
Project:
Arch. SUPERGELB
Architekten
Photography: HGEsch



Agemar HQ
Athens (Greece)
Project:
Arch. Eleftheria Deko
Photography:
Nikos Daniilidis



Omantel
Mascate (Oman)
Project:
Arch. Visual Energy
Photography:
Linea Light Group

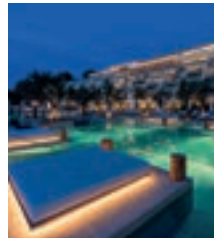

Four Season Hotel Nafsika
Athens (Greece)
Project:
Lighting designer: Lighting
Design International Studio,
London
Photography: Gavriilux
Papadiotis



Bosco Verticale
Milan (Italy)
Project:
Arch. Stefano Boeri
Photography:
Andrea Badoni

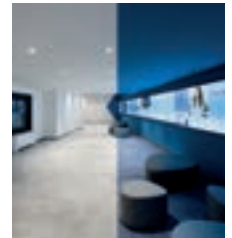

NGC HQ
Como (Italy)
Project:
Arch. Giuseppe Tortato
Architetti Firm
Photography:
Carola Merello

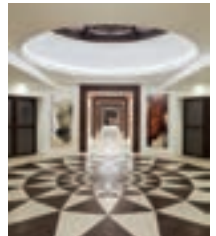

Barton Park
Perugia (Italy)
Project:
Arch. Studio Giovagnoni
Architetti Studio Bonucci
e Tognellini Drisaldi
Associati
Photography:
F16 Studio



Ferro Wine
Treviso (Italy)



Private house
Perugia (Italy)
Project:
Arch. A25design
Photography: Mattia
Micheli



Off. Prestito Felice
Milan (Italy)
Project:
Arch. CMA Design Studio
Arch. Giorgio Colombo
Photography:
Andrea Badoni

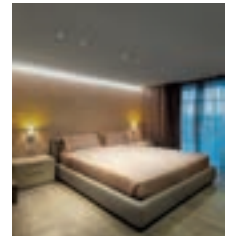

Private house
Milan (Italy)

credits



Shoowroom Copatlife
Pordenone (Italy)

Project:
Studio Gherardi

Photography:
Eye Studio



Melia Hotel
Petrovac (Montenegro)

Project:
Arch. Cedomir Mijovick

Photography: Milos
Martinovic

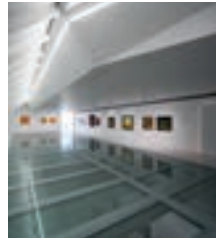

National Museum Riga
Riga (Lettonia)



Bloomingdale's
Kuwait City (Kuwait)

Project:
Lighting Design:
Nulty+Nulty+

Photography:
Romeo Productions



Annico church
Cremona (Italy)

Project:
Studio Archidue

Photography:
Francesco Roncoli



FKT
Venice (Italy)

Project:
Arch. Massimiliano
Pagnin

Photography:
Enrico Maria Verni



Universität Wr. Neustadt
(Austria)

Project:
Arch. Alexander Magyar

Photography: Alexander
Magyar



Grand Hotel Tremezzo
Como (Italy)

Project:
Arch. Silvia Perego

Photography:
Stefano Anzani



**Ristorante Gabin
Gusto Esclamativo**
Udine (Italy)

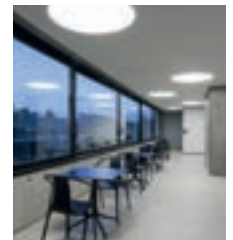

Ekipe Sporting Center
Catania (Italy)

Project:
Arch. Puleo Salvatore;
Arch. Catanese Angela;
Ing. Neri

Photography:
Fabio Gambina



Arcadia Center
Milan (Italy)

Project:
Arch. Giuseppe Tortato

Photography:
Moreno Maggi

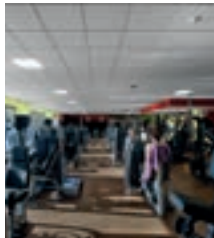

Happy Fit
Marghera (Italy)

Project:
Arch. Francesco Di Nisio

Photography:
Luigi De Nadai



NGC HQ
Como (Italy)

Project:
Arch. Giuseppe Tortato
Architetti Firm

Photography:
Carola Merello



NGC HQ
Como (Italy)

Project:
Arch. Giuseppe Tortato
Architetti Firm

Photography:
Carola Merello

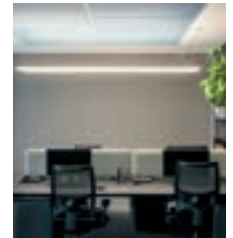

Off. Prestito Felice
Milan (Italy)

Project:
CMA Design Studio
Arch. Giorgio Colombo

Photography:
Andrea Badoni



Ca' Grande
Abano Terme (Italy)

Photography:
Studio Pointer



Uramakao
Sicily (Italy)

Project:
Arch. Salvo Puleo

Photography:
Giorgio Bottitta



Private House
Treviso (Italy)

Project:
Arch. Didonè Comacchio

Photography:
Alberto Sinigaglia



Residential Building
Milan (Italy)

Project:
Arch. Antonio Bonsante

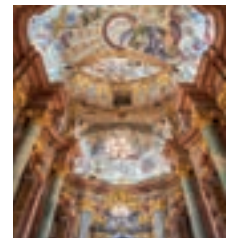

Kaplica
Hockberg (Poland)

Project:
Anpa Techniki
Oswietlenione Z.O.O.

Photography:
Szymon Aleksandrowicz

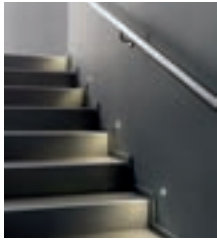

Off. Prestito Felice
Milan (Italy)
Project: CMA Design Studio
Arch. Giorgio Colombo
Photography: Andrea Badoni

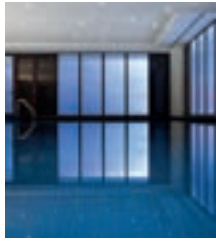

The Residency Tower
Puducherry (India)
Project: Lighting Designer: Litelab

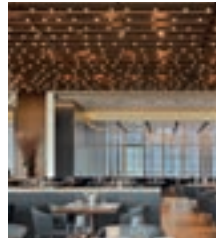

The River
New York City (USA)
Project: Bentel & Bentel
Photography: Arcphoto



Excelsior Hotel Gallia
Milan (Italy)
Project: Marco Piva Architetti
Photography: Fabio Gambina, Eye Studio



4-Spa
Catania (Italy)
Photography: Fabio Gambina, Eye Studio



Watergate hotel
Washington (USA)
Project: Arch. Cm Kling + Associates Inc.
Photography: Laura Arnold, Cm Kling + Associates Inc.

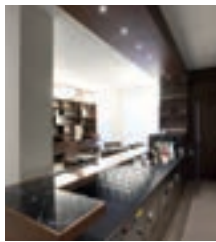

Eos Hotel
Lecce (Italy)



Almar Hotel
Jesolo (Italy)
Photography: Studio Pointer



Botanica di Leonardo
Florence (Italy)
Project: Studio Light Company
Photography: Lungimirante



Pixartprinting
Treviso (Italy)
Project: Arch. Zambonin Nicola
Photography: Corrado Covre



Vida Residence
Dubai (UAE)
Project: Lighting Design: Neolight
Photography: Neolight



Agemar HQ
Athens (Greece)
Project: Arch. Eleftheria Deko
Photography: Nikos Daniilidis



Villa San Gottardo
Vittorio Veneto (Italy)
Photography: Studio Pointer

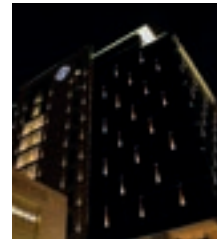

GV11
Dubai (UAE)
Project: Arch. Light Concept
Photography: Light Concept



Blue Waters Island
Dubai (UAE)
Project: Lighting Design: Neolight
Photography: Neolight

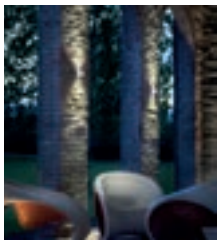

H-Farm
Treviso (Italy)
Photography: Studio Pointer



Private Residence
Treviso (Italy)

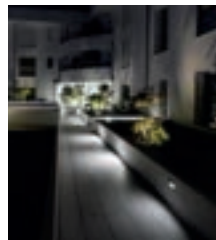

Private apartments
Jesolo (Italy)
Photography: Corrado Covre

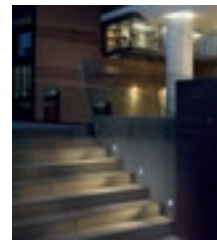

Almar Hotel
Jesolo (Italy)
Photography: Studio Pointer

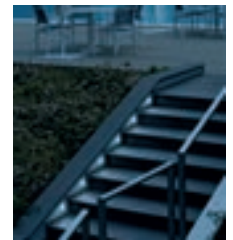

Private Residence
Venice (Italy)

credits



Sharjah Mosque
Dubai (UAE)
Project:
Study Light Concept
Photography:
Khacho Damerjian



Chq-building
Dublin (Ireland)



Ansam Yas Island
Abu Dhabi (UAE)
Photography:
Khacho Damerjian

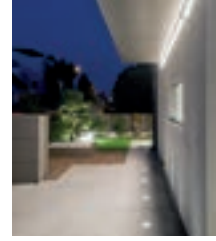

Private House
Castelfranco Veneto (Italy)
Project:
Arch. Enrico Scapinello



Private Residence
Castelfranco Veneto (Italy)
Photography:
Corrado Covre



Private Villa
Athens (Greece)
Project:
Ifi Group - Isv Architects
Photography:
Yannis Kontos
Photo Journalist

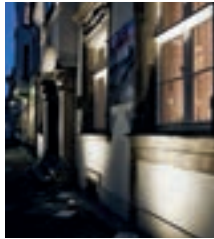

Marionette Theatre
Düsseldorf (Germany)
Project:
Arch. Doc. Edmund Spohr, Dus-illuminated
Photography:
Corrado Covre



Four Season Astir Palace Hotel
Athens (Greece)
Project:
Lighting design: L+DG Lighting Architects
Photography:
Gavrilux Papadiotis

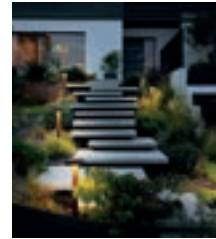

Private Residence
Leman (Switzerland)
Project:
Lighting planning: DCUBE. Swiss
Photography:
DCUBE.Swiss

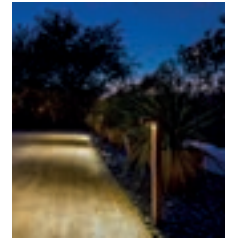

Private Residence
Treviso (Italy)



Capricorn Bridge
Dusseldorf (Germany)
Project:
Arch. SUPERGELB Architekten
Photography:
HGESch



Vida Residence
Dubai (UAE)
Project:
Lighting Design: Neolight
Photography:
Neolight

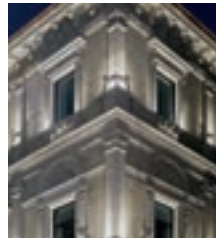

Via Broletto, ESA engineering
Milan (Italy)
Project:
Antonio Buonsante
Photography:
Antonio Buonsante



College Place d'Armes
Yverdon-les-Bains (Switzerland)

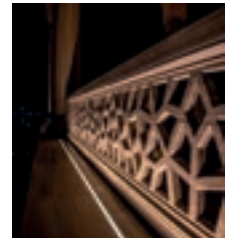

Sharjah Mosque
Dubai (UAE)
Project:
Study Light Concept
Photography:
Khacho Damerjian

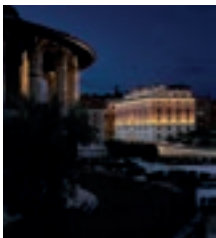

Hotel 47
Roma (Italy)
Project:
Studio Faber Technica s.a.s.
Photography:
Matteo Canestraro



GV11
Dubai (UAE)
Project:
Light Concept
Photography:
Light Concept



Private HouseMilan (Spain)
Project:
Vié Il·luminació
Photography:
Vié Il·luminació



Private residence
Padova (Italy)



Private Residence
Leman (Switzerland)
Project:
Lighting planning: DCUBE. Swiss
Photography:
DCUBE.Swiss



GV11
Dubai (UAE)
Project:
Light Concept
Photography:
Light Concept

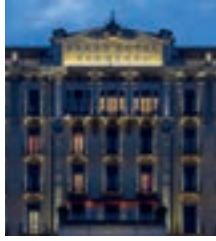

Grand Hotel Tremezzo
Como (Italy)
Project:
Arch. Silvia Perego
Photography:
Stefano Anzani

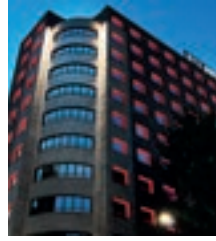

NYX Hotel
Milan (Italy)
Project:
Arch. Studio Luce Sacchi
Photography:
Andrea Badoni

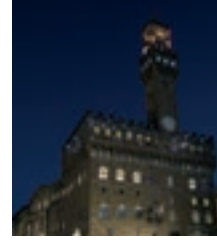

Palazzo Vecchio
Florence (Italy)
Photography:
Lungimirante Productions

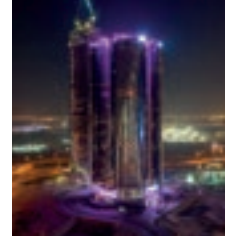

Damac Tower
Dubai (UAE)
Project KEO:
Lighting Concept: DPA
Lighting Consultants:
Oxford
Photography:
Linea Light Group



Private residence
(Greece)
Project:
Ifi Group
Isv Architects



**Caramel Grecotel
Boutique Resort**
Crete (Greece)
Project:
Visual Energy

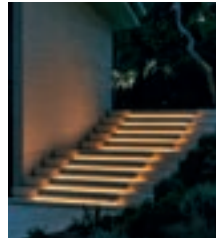

Four Season Hotel
Athens (Greece)
Project:
Lighting design: L+DG
Lighting Architects
Photography: Gavriilux
Papadiotis

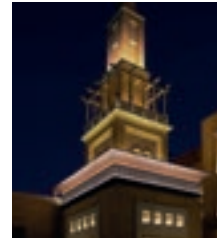



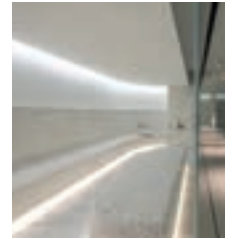





































Ansam Yas Island
Abu Dhabi (UAE)
Photography:
Khacho Damergian



Four Season Hotel
Athens (Greece)
Project:
Lighting design: L+DG
Lighting Architects
Photography: Gavriilux
Papadiotis

how to read symbols

	Installation en milieu intérieur		Classe III - classe d'isolation électrique (IEC)
	Installation en milieu extérieur		Over Voltage Protection
	Installation murale		Smartwave™
	Installation au sol	C.C.	Constant Current
	Installation au plafond	C.V.	Constant Voltage
	Installation au mur ou au sol		Gradation avec potentiomètre intégré
	Installation au plafond ou au mur		Simply DIM
	Installation au plafond, au mur ou au sol		Phase-cut
	Installation au plafond ou au sol		1-10 V
	Indice de protection (IEC 60529) contre les corps étrangers et l'eau		Digital Addressable Lighting Interface
	Produit conçu pour résister aux immersions temporaires		Digital Addressable Lighting Interface
	Indice de protection sur le compartiment optique		Digital Addressable Lighting Interface
	Indice de protection (IEC 62262) contre les impacts mécaniques externes	DMX 512	DMX 512
	Appareil piétinable		RDM, DMX 512
	Appareil carrossable		Infrarouge
	Acier inoxydable		Télécommande radiofréquence
	Article protégé par résine		Capteur PIR
	Trou d'installation circulaire		Alimentation avec transformateur de sécurité
	Trou d'installation quadrangulaire		Alimentation indépendante
	Faisceau lumineux orientable		Alimentation électrique protégée thermiquement
	Faisceau lumineux basculant		Isolation renforcée
	Disponible en version urgence		Unified Glare Rating
	Cordon d'alimentation inclus		Capteur de mouvement
	Appareil adapté au montage sur meubles		Antenne intégrée
	Appareil adapté au montage sur des surfaces normalement inflammables (EN 60598)		Antenne externe
	Appareil avec protection thermique intégrée		
	Driver inclus		
	Driver non inclus		
	Classe I - classe d'isolation électrique (IEC)		
	Classe II - classe d'isolation électrique (IEC)		

Tous les articles sont de classe énergétique A++.
Les schémas de connexion des composants électroniques sont disponibles dans la documentation technique.

finishes materials



Blanc | RAL 9003 gaufré



Gris | RAL 9006 gaufré

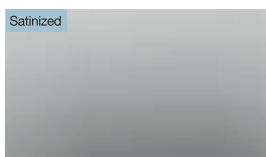

Satiné



Apprêt

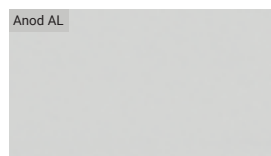

Aluminium anodisé



Aluminium



Acier



Nickel brossé

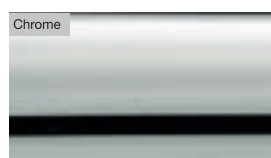

Chrome

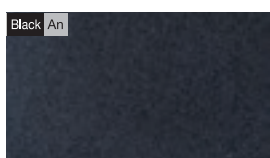

Noir anodisé

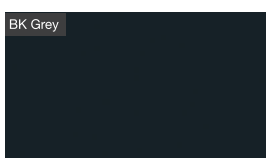

Gris noir | RAL 7021 gaufré



Noir | RAL 9005 gaufré

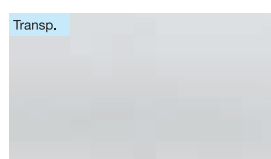

PMMA Transparent

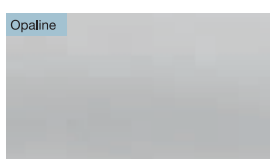

PMMA Opalin



Or

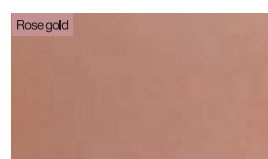

Or rose



Laiton



Bronze



Marron

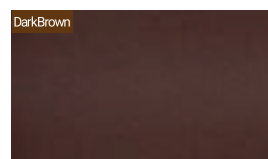

Dark brown

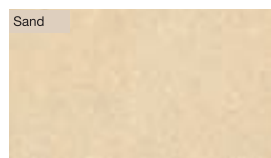

Sable



Béton

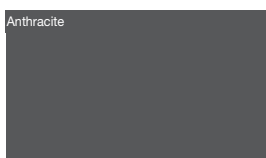

Anthracite

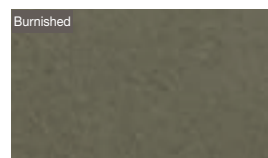

Bruni

Les dessins, les cotes, les matériaux et les couleurs du présent catalogue sont donnés à titre indicatif. Dans l'intérêt des clients, la société se réserve le droit de modifier les modèles à tout moment et sans préavis.

L'indication du drapeau italien dans le présent catalogue est purement indicative. Les produits peuvent avoir des origines différentes de celles indiquées.

«Linea Light Group» se réserve le droit, à tout moment et sans préavis, de modifier les caractéristiques de ses produits et leur disponibilité. Tous les produits, données techniques, illustrations et informations du catalogue ne sont pas contractuels pour «Linea Light Group». «Linea Light Group» ne pourra être tenu responsable des éventuelles erreurs d'illustration, de texte et/ou de traduction. Les autres caractéristiques des produits sont décrites dans les fiches techniques et les notices d'instructions correspondantes. Ce catalogue est protégé par la loi sur les droits d'auteur (loi 22/04/1941 n° 633 et loi 14/12/1942 n° 1485 : toute reproduction totale ou partielle du présent catalogue est interdite).

Toutes les valeurs indiquées dans ce catalogue sont des valeurs mesurées. Les données de flux, de CCT et de puissance sont soumises à des tolérances de +/- 10 %.

codes index

CODE	Product	Page	CODE	Product	Page	CODE	Product	Page	CODE	Product	Page
		655									
14931	Accessories	661	62510.U	Onsight_W	454	62922	Pool_S	260	63737	Tour_PI	239
		685	62511.L	Onsight_W	454	62923	Pool_S	260	63738	Tour_PI	239
		817	62511.R	Onsight_W	454	62925	Pool_S	260	63740	Tour_CD	234
53890	Accessories	689	62511.U	Onsight_W	454	62926	Pool_P	261	63750	Tour_CD	234
56990	Accessories	689	62514	Fled_E	452	62931	Pool_C	260	63760	Tour_CD	234
58675	Accessories	687	62520.L	Onsight_SF	454	62932	Pool_C	260	63772	Accessories	248
59165	Joe	655	62520.R	Onsight_SF	454	62933	Pool_C	260	63773	Accessories	248
59166	Joe	655	62520.U	Onsight_SF	454	62934	Pool_C	260	63778	Accessories	248
59950	Accessories	687	62521.L	Onsight_SF	454	62935	Pool_C	260	63779	Accessories	248
60830	Accessories	133	62521.R	Onsight_SF	454	62936	Pool_C	260	63782	Accessories	248
60861	Rollip60_MP	320	62521.U	Onsight_SF	454			317	63783	Accessories	248
60862	Rollip60_MP	320	62524	Fled_P	453	63300	Accessories	319	63788	Accessories	248
60863	Rollip60_MP	320	62530.S	Onsight_SF	454			321	63789	Accessories	248
60864	Rollip60_MP	320	62530.U	Onsight_SF	454			317	63798	Accessories	248
60865	Rollip60_MP	320	62531.S	Onsight_SF	454			317	63799	Accessories	248
60866	Rollip60_MP	320	62531.U	Onsight_SF	454	63301	Accessories	319	63945	Rollip7035_MP	318
60867	Rollip60_MP	320	62534	Fled_P	453			319	63946	Rollip7035_MP	318
60868	Rollip60_MP	320	62540.L	Onsight_RF	455			321	63947	Rollip7035_MP	318
60869	Rollip35_PC	322	62540.R	Onsight_RF	455			321	63948	Rollip7035_MP	318
60871	Rollip35_PC	322	62540.U	Onsight_RF	455	63302	Accessories	319	63949	Rollip7035_MP	318
60872	Rollip35_PC	322	62541.L	Onsight_RF	455			321	63955	Rollip7035_MP	318
60873	Rollip35_PC	322	62541.R	Onsight_RF	455	63445	Stalk	689	63956	Rollip7035_MP	318
60874	Rollip35_PC	322	62541.U	Onsight_RF	455	63446	Stalk	689	63957	Rollip7035_MP	318
60875	Rollip35_PC	322	62544	Fled_O	453	63455	Stalk	689	63958	Rollip7035_MP	318
60876	Rollip35_PC	322	62550.S	Onsight_RF	455	63456	Stalk	689	63959	Rollip7035_MP	318
60877	Rollip7035_PC	322	62550.U	Onsight_RF	455	63465	Stalk	689	63965	Rollip7035_MP	318
60878	Rollip7035_PC	322	62551.S	Onsight_RF	455	63466	Stalk	689	63966	Rollip7035_MP	318
60879	Rollip7035_PC	322	62551.U	Onsight_RF	455	63495	Stalk	689	63967	Rollip7035_PC	322
60881	Rollip60_PC	323	62554	Fled_O	453	63496	Stalk	689	63968	Rollip7035_PC	322
60883	Rollip60_PC	323	62757	Accessories	783	63499	Stalk	689	63969	Rollip7035_PC	322
60884	Rollip60_PC	323	62758	Accessories	783	63505	Stalk	689	63975	Rollip7035_PC	322
60885	Rollip60_PC	323	62761	Silicone_F	782	63506	Stalk	689	63976	Accessories	319
60886	Rollip60_PC	323	62781	Rollip7035_MP	318	63560L02	Accessories	916	64005	Accessories	314
60887	Rollip60_PC	323	62782	Rollip7035_MP	318	63700	Accessories	249			317
60888	Rollip60_PC	323	62783	Rollip7035_MP	318	63701	Accessories	248	64006	Accessories	315
60889	Rollip60_MP	320	62784	Rollip7035_MP	318	63702	Accessories	248			321
60891	Rollip35_PC	322	62785	Rollip7035_MP	318	63703	Accessories	248	64015	Accessories	314
60892	Rollip7035_PC	322	62786	Rollip7035_MP	318	63704	Accessories	248			317
60893	Rollip60_PC	323	62787	Rollip7035_MP	318	63706	Accessories	248	64016	Accessories	315
61115	Pilos	687	62788	Rollip7035_MP	318	63707	Accessories	248			321
61125	Pilos	687	62789	Rollip7035_MP	318	63708	Accessories	248	64025	Accessories	317
61145	Pilos	687	62791	Rollip7035_MP	318	63709	Accessories	248			315
62403	Silicone_C	909	62792	Rollip7035_MP	318	63710	Tour_R	232	64026	Accessories	321
62403N	Silicone_C	909	62793	Rollip7035_MP	318	63711	Tour_D	241			314
62460	Accessories	304	62794	Rollip7035_PC	322	63712	Tour_D	241	64035	Accessories	317
62461	Accessories	304	62795	Rollip7035_PC	322	63713	Tour_D	241			317
62462	Accessories	304	62796	Rollip7035_PC	322	63714	Tour_D	241	64045	Accessories	319
62463	Accessories	304	62797	Rollip7035_PC	322	63716	Accessories	248	64055	Accessories	319
62464	Accessories	304			365	63717	Accessories	248	64065	Accessories	319
62465	Accessories	304			365	63720	Tour_R	232	64075	Accessories	319
62470	RollipPRO	304			366	63721	Tour_CI	235	64200	Accessories	667
62471	RollipPRO	304			366	63722	Tour_CI	235	64210	Accessories	681
62472	RollipPRO	304			366	63723	Tour_CI	235	64240	Accessories	249
62473	RollipPRO_C	305			367			234	64250	Tour_QV	244
62474	RollipPRO_C	305	62900	Accessories	367	63724	Accessories	235	64252	Apache	681
62500.L	Onsight_W	454			367	63726	Tour_PD	238	64253	Apache	681
62500.R	Onsight_W	454			368	63727	Tour_PD	238	64254	Apache	681
62500.U	Onsight_W	454			368	63728	Tour_PD	238	64255	Apache	681
62501.L	Onsight_W	454			368	63729	Tour_PD	238	64256	Apache	681
62501.R	Onsight_W	454			369	63730	Tour_R	232	64257	Apache	681
62501.U	Onsight_W	454	62911	Pool_S	260	63731	Tour_PU	240	64258	Apache	681
62504	Fled_E	452	62912	Pool_S	260	63732	Tour_PU	240	64259	Apache	681
62510.L	Onsight_W	454	62915	Pool_S	260	63733	Tour_PU	240	64260	Tour_QV	244
62510.R	Onsight_W	454	62916	Pool_P	261	63734	Tour_PU	240	64262	Apache	681
			62921	Pool_P	261	63736	Tour_PI	239	64263	Apache	681

CODE	Product	Page	CODE	Product	Page	CODE	Product	Page	CODE	Product	Page
64264	Apache	681	64509	Cell	134	64631	Gypsum_Cell	132	64723	Ryo	650
64265	Apache	681	64510	Cell	134	64632	Gypsum_Cell	132	64724	Ryo	651
64266	Apache	681	64520	Vuelta	817	64633	Gypsum_Cell	132	64726	Ryo	650
64267	Apache	681	64521	Vuelta	817			314	64727	Ryo	651
64268	Apache	681	64522	Vuelta_Y	817	64634	Accessories	317	64728	Ryo	650
64269	Apache	681	64523	Vuelta_Y	817	64635	Joe	655	64729	Ryo	651
64270	Accessories	249	64526	Cell	134	64636	Joe	655	64734	Ryo	650
64272	Rollip7035_MP	318	64527	Cell	134	64637	Gypsum_Cell	132	64735	Ryo	651
64273	Rollip7035_MP	318	64528	Vuelta	817	64638	Gypsum_Cell	132	64736	Ryo	650
64274	Rollip7035_MP	318	64529	Vuelta	817			317	64737	Ryo	651
64275	Rollip7035_MP	318	64530	Vuelta_Y	817	64639	Accessories	319	64738	Baton_R	283
64276	Rollip7035_MP	318	64531	Vuelta_Y	817			321	64739	Baton_Q	283
64277	Rollip7035_MP	318	64532	Accessories	817	64640	Accessories	775	64740	Baton_Q	283
64278	Rollip7035_PC	322	64533	Accessories	817	64641	Accessories	775	64741	Baton_P	282
64279	Rollip7035_PC	322	64534	Accessories	817	64642	Dirigo_FL2	776	64742	Baton_P	282
64280	Accessories	319	64536	Accessories	817	64643	Dirigo_FL2	776	64743	Baton_P	282
64282	Rollip7035_MP	318	64537	Accessories	817	64644	Dirigo_M2 Master	774	64744	Baton_P	282
64283	Rollip7035_MP	318	64538	Accessories	817	64645	Dirigo_M2 Master	774	64745	Baton_Q	283
64284	Rollip7035_MP	318	64539	Accessories	817	64646	Dirigo_M2 Slave	774	64746	Baton_Q	283
64285	Rollip7035_MP	318	64540	Cell	134	64647	Dirigo_M2 Slave	774	64747	Baton_R	283
64286	Rollip7035_MP	318	64541	Cell	134	64648	Dirigo_M1 Slave	777	64749	Baton_R	283
64287	Rollip7035_MP	318	64542	Cell	135			317	64754	Baton_P	282
64288	Rollip7035_PC	322	64543	Cell	135	64649	Accessories	319	64755	Baton_P	282
64289	Rollip7035_PC	322	64544	Cell	135			321	64756	Baton_Q	283
		315	64545	Cell	135			317	64757	Baton_Q	283
64297	Accessories	321	64546	Gypsum_Cell	132	64660	Accessories	319	64758	Accessories	651
		315	64547	Gypsum_Cell	132			321	64759	Ryo	650
64298	Accessories	321	64548	Gypsum_Cell	133	64661	Accessories	775	64760	Ryo	650
		315	64549	Gypsum_Cell	133	64662	Accessories	775	64761	Ryo	650
64299	Accessories	321	64550	Gypsum_Cell	133	64663	Accessories	775	64762	Ryo	651
64300	Peak-Maxi_DL	673	64551	Gypsum_Cell	133	64664	Dirigo_M2 IN-Corner	774	64763	Ryo	651
64301	Peak-Maxi_DL	673	64560	Cem_W	502	64665	Dirigo_M2 IN-Corner	774	64764	Ryo	651
64302	Peak-Maxi_DL	673	64561	Cem_W	502	64666	Dirigo_M2 IN-Corner	774			317
64328	Accessories	249	64562	Cem_W	502	64667	Dirigo_M2 OUT-Corner	774	64776	Accessories	319
64329	Accessories	249	64563	Cem_W	503	64668	Dirigo_M2 OUT-Corner	774			321
64338	Accessories	249	64564	Cem_C	502	64669	Dirigo_M2 OUT-Corner	774	64782	Baton_P	282
64339	Accessories	249	64570	Tour_PD	238	64670	Accessories	249	64783	Baton_P	282
64348	Accessories	249	64571	Tour_PD	238	64671	Accessories	249	64784	Baton_P	282
64349	Accessories	249	64572	Tour_PD	238	64673	Accessories	249	64785	Baton_P	282
64358	Accessories	249	64573	Tour_PD	238	64682	Tour_PU	240	64786	Baton_P	282
64359	Accessories	249	64575	Accessories	249	64683	Tour_PU	240	64787	Baton_P	282
64360	Tour_Q	244	64577	Tour_PI	239	64685	Tour_PU	240	64788	Peak	672
64361	Tour_Q	244	64578	Accessories	248	64686	Tour_PU	240	64789	Peak	672
64362	Tour_Q	244	64579	Tour_PI	239	64687	Tour_PU	240	64790	Peak	672
64363	Tour_QD	245	64580	Accessories	248	64689	Tour_PU	240	64791	Peak	672
64364	Tour_QD	245	64581	Tour_PI	239	64690	Tour_PU	240	64792	Peak	672
64365	Tour_QD	245	64583	Tour_PU	240	64691	Tour_PU	240	64793	Peak	672
64368	Accessories	249	64584	Tour_PU	240	64693	Tour_PU	240	64794	Peak	672
64369	Accessories	249	64585	Tour_PU	240	64694	Tour_PU	240	64795	Peak	672
64370	Tour_Q	244	64586	Accessories	248	64695	Tour_PU	240	64796	Peak	672
64371	Tour_Q	244	64587	Tour_PU	240	64697	Tour_PU	240	64804	Fled_E	452
64372	Tour_Q	244	64588	Accessories	248			315	64814	Fled_E	452
64373	Tour_QD	245	64589	Accessories	775	64698	Accessories	321	64824	Fled_P	453
64374	Tour_QD	245	64590	Dirigo_FL1 Steel	776			315	64834	Fled_P	453
64375	Tour_QD	245	64591	Dirigo_M1 Master	777	64699	Accessories	321	64844	Fled_O	453
64378	Accessories	249	64592	Accessories	775	64700	Puro	663	64854	Fled_O	453
64379	Accessories	249	64593	Accessories	775	64701	Puro	663	65002	Accessories	503
64388	Accessories	249	64594	Dirigo_FL2	776	64715	Puro	663	65003	Fylo+ Recessed_3	366
64389	Accessories	249	64595	Dirigo_M2 Master	774	64716	Puro	663	65004	Fylo+ Recessed_3	366
64398	Accessories	249	64597	Dirigo_M2 Slave	774	64717	Puro	663	65005	Accessories	503
64399	Accessories	249	64610	Puro	663	64718	Puro	663	65006	Fylo+Recessed_2	366
64505	Cem_WF	503	64611	Puro	663	64719	Puro	663	65007	Fylo+Recessed_2	366
64506	Cem_WF	503	64612	Puro	663	64720	Puro	663	65008	Accessories	368
64507	Cell	134	64613	Puro	663	64721	Ryo	650	65009	Fylo+Recessed_4	367
64508	Cell	134	64630	Gypsum_Cell	132	64722	Ryo	651			

codes index

CODE	Product	Page	CODE	Product	Page	CODE	Product	Page	CODE	Product	Page
65010	Fylo+Recessed_4	367	65104	Tour_PI	239	65203	Rollip70_MC	310	65253	Rollip35_MP	316
		368	65105	Tour_PI	239	65204	Rollip35_MC	308	65254	Rollip35_MP	316
65011	Accessories	369	65107	Tour_PI	239	65205	Rollip35_MC	308	65255	Rollip35_MP	316
65012	Fylo+Recessed_5	367	65108	Tour_PI	239	65206	Rollip35_MC	308	65256	Rollip35_PC	322
65013	Fylo+Recessed_5	367	65109	Tour_PI	239	65207	Rollip35_MC	308	65257	Rollip35_PC	322
		368	65111	Tour_PI	239			311	65258	Rollip35_PC	322
65014	Accessories	369	65112	Tour_PD	238	65208	Accessories	319	65259	Rollip35_PC	322
			65113	Tour_PD	238			311	65260	Rollip35_MS	314
65015	Fylo+Surface_1	368	65115	Tour_PD	238	65209	Accessories	319	65261	Rollip35_MS	314
65016	Fylo+Surface_1	368	65116	Tour_PD	238			311	65262	Rollip35_MS	314
65018	Fylo+Surface_2	368	65117	Tour_PD	238	65210	Accessories	319	65263	Rollip35_MS	314
65019	Fylo+Surface_2	368	65119	Tour_PD	238			311	65264	Rollip35_MS	314
65021	Fylo+Surface_3	368	65120	Tour_PD	238	65211	Accessories	319	65265	Rollip35_MS	314
65022	Fylo+Surface_3	368	65121	Tour_PD	238			309	65266	Rollip35_MS	314
65023	Accessories	783	65123	Tour_PD	238	65212	Accessories	314	65267	Rollip35_MS	314
65024	Fylo+Surface_4	368	65124	Tour_PD	238			317	65270	Rollip35_PC	322
65025	Fylo+Surface_4	368	65125	Tour_PD	238			309	65271	Rollip35_PC	322
65026	Accessories	783	65127	Tour_PD	238	65213	Accessories	314	65272	Rollip35_MP	316
65027	Fylo+ Recessed_1	366	65128	Tour_PD	238			317	65273	Rollip35_MP	316
65028	Fylo+ Recessed_1	366	65129	Tour_PD	238			309	65274	Rollip35_MP	316
65032	Fylo+ Recessed_1	366	65130	Tour_PD	238	65214	Accessories	314	65275	Rollip35_MP	316
65035	Accessories	783	65131	Tour_PD	238			317	65276	Rollip35_MP	316
65036	Fylo+Out	782	65132	Tour_PI	239			309	65277	Rollip35_MP	316
65037	Fylo+Out	782	65133	Tour_PI	239	65215	Accessories	314	65278	Rollip35_MP	316
65038	Accessories	783	65134	Tour_PI	239			317	65279	Rollip35_MP	316
65039	Fylo+Out	782	65135	Tour_PU	240	65216	Rollip35_C	312	65280	Rollip35_PC	322
65040	Fylo+Out	782	65136	Tour_PU	240	65217	Rollip35_C	312	65281	Rollip35_PC	322
65045	Fylo+Recessed_2	366	65137	Tour_PU	240			311	65282	Rollip35_MP	316
65046	Fylo+ Recessed_3	366	65138	Tour_PU	240	65218	Accessories	311	65283	Rollip35_MP	316
65047	Fylo+Recessed_4	367	65141	Accessories	249			309	65284	Rollip35_MP	316
65048	Fylo+Recessed_5	367	65142	Accessories	248	65219	Accessories	309	65285	Rollip35_MP	316
65049	Fylo+Surface_1	368	65143	Accessories	248			310	65286	Rollip35_MP	316
65053	Fylo+Surface_2	368	65144	Accessories	248	65220	Rollip70_MC	310	65287	Rollip35_MP	316
		366	65145	Accessories	248	65221	Rollip70_MC	310	65288	Rollip35_MP	316
		366	65148	Accessories	248	65222	Rollip70_MC	310	65289	Rollip35_MP	316
65054	Accessories	367	65149	Accessories	248	65225	Rollip70_C	312			317
		368	65150	Accessories	248	65226	Rollip70_C	312	65290	Accessories	319
		369	65151	Accessories	248	65228	Rollip70_C	312			321
		366	65152	Accessories	248	65229	Rollip70_C	312		Accessories	314
		367	65153	Accessories	248	65231	Rollip70_MC	310	65291		317
65055	Accessories	368	65154	Accessories	248	65232	Rollip70_MC	310	65292	Rollip35_MS	314
		369	65155	Accessories	248	65233	Rollip35_MC	308	65293	Rollip35_MS	314
65058	Fylo+Surface_3	368	65158	Accessories	248			309	65294	Rollip35_MS	314
65059	Fylo+Surface_4	368	65159	Accessories	248	65234	Accessories	314	65295	Rollip35_MS	314
65063	Peak-Maxi_L	673	65160	Accessories	248			317	65296	Rollip35_MS	314
65064	Peak-Maxi_L	673	65161	Accessories	248			309	65297	Rollip35_MS	314
65065	Peak-Maxi_L	673	65180	Fylo+	365	65235	Accessories	314	65298	Rollip35_MS	314
65072	Peak-Maxi	672	65181	Fylo+	365			317	65299	Rollip35_MS	314
65073	Peak-Maxi	672			365	65236	Accessories	311	65300	Tour_D	241
65074	Peak-Maxi	672	65182	Accessories	369	65237	Accessories	311	65301	Tour_D	241
65075	Accessories	673			365	65238	Accessories	311	65302	Tour_D	241
65076	Accessories	673	65183	Accessories	369	65239	Accessories	311	65304	Tour_D	241
65077	Accessories	673			365	65240	Rollip35_MP	316	65305	Tour_D	241
65078	Accessories	673	65184	Accessories	369	65241	Rollip35_MP	316	65306	Tour_D	241
65082	Accessories	673			365	65242	Rollip35_MP	316	65307	Tour_D	241
65083	Peak-Maxi_W	673	65187	Fylo+	365	65243	Rollip35_MP	316	65308	Tour_D	241
65084	Peak-Maxi_W	673	65190	Cell_S	277	65244	Rollip35_MP	316	65310	Tour_D	241
65085	Peak-Maxi_W	673	65191	Cell_S	277	65245	Rollip35_MP	316	65311	Tour_D	241
65090	Fylo+Out	782	65192	Cell_S	277	65246	Rollip35_MP	316	65312	Tour_D	241
65093	Fylo+Out	782	65193	Cell_S	277	65247	Rollip35_MP	316	65313	Tour_D	241
65094	Accessories	783	65197	Peak-Maxi_DL	673	65248	Rollip35_MP	316	65314	Tour_D	241
		368	65198	Peak-Maxi_DL	673	65249	Rollip35_MP	316	65316	Tour_D	241
65097	Accessories	369	65199	Peak-Maxi_DL	673	65250	Rollip35_MP	316	65317	Tour_D	241
65100	Tour_PI	239	65200	Rollip70_MC	310	65251	Rollip35_MP	316	65318	Tour_D	241
65101	Tour_PI	239	65201	Rollip70_MC	310	65252	Rollip35_MP	316	65319	Tour_D	241
65103	Tour_PI	239	65202	Rollip70_MC	310						

CODE	Product	Page	CODE	Product	Page	CODE	Product	Page	CODE	Product	Page
65320	Tour_D	241	65393	Opti-pole	667	65462	Rollip70_C	312	65527	Rollip60_MS	315
65322	Tour_D	241	65394	Opti-pole	667	65463	Rollip70_C	312	65528	Rollip60_MS	315
65323	Tour_D	241	65395	Opti-pole	667	65464	Rollip70_C	312	65529	Rollip60_MS	315
65324	Accessories	248	65396	Opti-pole	667	65465	Rollip35_MP	316	65530	Rollip60_MS	315
65325	Accessories	248	65397	Opti-pole	667	65466	Rollip35_MP	316	65531	Rollip60_MS	315
65326	Accessories	248	65398	Accessories	248	65467	Rollip35_MP	316	65532	Rollip60_MS	315
65327	Accessories	248	65399	Accessories	248	65468	Rollip35_MP	316	65533	Rollip60_MS	315
65328	Accessories	248	65400	Peak-Maxi_L	673	65469	Rollip35_MP	316	65534	Rollip60_MS	315
65329	Accessories	248	65401	Peak-Maxi_L	673	65470	Rollip35_MP	316	65535	Rollip60_MS	315
65332	Accessories	248	65402	Peak-Maxi_L	673	65471	Rollip35_MP	316	65536	Rollip60_MS	315
65333	Accessories	248	65403	Peak	672	65472	Rollip35_MP	316	65537	Rollip60_MS	315
65334	Accessories	248	65404	Peak	672	65473	Rollip35_MP	316	65538	Rollip60_MS	315
65335	Accessories	248	65405	Peak	672	65474	Rollip35_MP	316	65539	Rollip60_MS	315
65336	Accessories	248	65406	Peak-Maxi	672	65475	Rollip35_MP	316	65540	Rollip60_MS	315
65337	Accessories	248	65407	Peak-Maxi	672	65476	Rollip35_MP	316	65541	Rollip60_MP	320
65338	Accessories	248	65408	Peak-Maxi	672	65477	Rollip35_MP	316	65542	Rollip60_MP	320
65339	Accessories	248	65409	Peak-Maxi_W	673	65478	Rollip35_MP	316	65543	Rollip60_MP	320
65340	Accessories	248	65410	Peak-Maxi_W	673	65479	Rollip35_MP	316	65544	Rollip60_MP	320
65341	Accessories	248	65411	Peak-Maxi_W	673	65480	Rollip35_MP	316	65545	Rollip60_MP	320
65344	Accessories	248	65412	Accessories	248	65481	Rollip35_MP	316	65546	Rollip60_MP	320
65345	Accessories	248	65413	Accessories	248	65482	Rollip35_MP	316	65547	Rollip60_MP	320
65346	Accessories	248	65414	Accessories	248	65483	Rollip35_MP	316	65548	Rollip60_MP	320
65347	Accessories	248	65416	Accessories	248	65484	Rollip35_MP	316	65549	Rollip60_MP	320
65349	Accessories	248	65417	Accessories	248	65485	Rollip35_MP	316	65550	Rollip60_MP	320
65350	Tour_CD	234	65418	Accessories	248	65486	Rollip35_MP	316	65551	Rollip60_MP	320
65351	Tour_CD	234	65419	Accessories	248	65487	Rollip35_MP	316	65552	Rollip60_MP	320
65352	Tour_CD	234	65420	Tour_R	232	65488	Rollip35_MP	316	65553	Rollip60_MP	320
65354	Tour_CD	234	65421	Tour_R	232	65489	Rollip35_MP	316	65554	Rollip60_MP	320
65355	Tour_CD	234	65422	Tour_R	232	65490	Rollip35_MP	316	65555	Rollip60_MP	320
65356	Tour_CD	234	65424	Tour_R	232	65491	Rollip35_MP	316	65556	Rollip60_MP	320
65357	Tour_CD	234	65425	Tour_R	232	65492	Rollip35_MP	316	65557	Rollip60_MP	320
65358	Tour_CD	234	65426	Tour_R	232	65493	Rollip35_MP	316	65558	Rollip60_MP	320
65360	Tour_CD	234	65427	Tour_R	232	65494	Rollip35_MP	316	65559	Rollip60_MP	320
65361	Tour_CD	234	65428	Tour_R	232	65495	Rollip35_MP	316	80009	Quantum_R	34
65362	Tour_CD	234	65430	Tour_R	232	65496	Rollip35_MP	316	80010	Quantum_R	34
65363	Tour_CD	234	65431	Tour_R	232	65497	Rollip35_MS	314	80011	Quantum_R	34
65364	Tour_CD	234	65432	Tour_R	232	65498	Rollip35_MS	314	80012	Quantum_R	34
65366	Tour_CD	234	65433	Tour_R	232	65499	Rollip35_MS	314	80013	AntonX	105
65367	Tour_CD	234	65434	Tour_R	232	65500	Rollip35_MS	314	80014	AntonX	105
65368	Tour_CI	235	65436	Tour_R	232	65501	Rollip35_MS	314	80015	AntonX	105
65369	Tour_CI	235	65437	Tour_R	232	65502	Rollip35_MS	314	80016	AntonX	105
65370	Tour_CI	235	65438	RollipPRO	304	65503	Rollip35_MS	314	80017	Quantum_R	34
65372	Tour_CI	235	65439	RollipPRO	304	65504	Rollip35_MS	314	80018	Quantum_R	34
65373	Tour_CI	235	65440	RollipPRO	304	65505	Rollip35_MS	314	80019	Quantum_R	34
65374	Tour_CI	235	65441	RollipPRO	304	65506	Rollip35_MS	314	80020	Quantum_R	34
65375	Tour_CI	235	65442	RollipPRO_C	305	65507	Rollip35_MS	314	80021	Quantum_R	34
65376	Tour_CI	235	65443	RollipPRO_C	305	65508	Rollip35_MS	314	80022	Quantum_R	34
65378	Tour_CI	235	65444	Rollip35_MC	308	65509	Rollip35_MS	314	80023	Quantum_R	34
65379	Tour_CI	235	65445	Rollip35_MC	308	65510	Rollip35_MS	314	80024	Quantum_R	34
65380	Tour_CI	235	65446	Rollip35_MC	308	65511	Rollip35_MS	314	80025	Quantum_R	34
65381	Tour_CI	235	65447	Rollip35_MC	308	65512	Rollip35_MS	314	80026	Quantum_R	34
65382	Tour_CI	235	65448	Rollip35_MC	308	65513	Rollip7035_MP	318	80027	Quantum_R	34
65384	Tour_CI	235	65449	Rollip70_MC	310	65514	Rollip7035_MP	318	80028	Quantum_R	34
65385	Tour_CI	235	65450	Rollip70_MC	310	65515	Rollip7035_MP	318	80029	Quantum_R	35
		234	65451	Rollip70_MC	310	65516	Rollip7035_MP	318	80030	Quantum_R	35
65386	Accessories	235	65452	Rollip70_MC	310	65517	Rollip7035_MP	318	80031	Quantum_R	35
		234	65453	Rollip70_MC	310	65518	Rollip7035_MP	318	80032	Quantum_R	35
65387	Accessories	235	65454	Rollip70_MC	310	65519	Rollip7035_MP	318	80033	Quantum_R	35
		234	65455	Rollip70_MC	310	65520	Rollip7035_MP	318	80034	Quantum_R	35
65389	Accessories	235	65456	Rollip70_MC	310	65521	Rollip7035_MP	318	80035	Quantum_R	35
		234	65457	Rollip70_MC	310	65522	Rollip7035_MP	318	80036	Quantum_R	35
65390	Accessories	235	65458	Rollip70_MC	310	65523	Rollip7035_MP	318	80037	Quantum_R	35
		234	65459	Rollip35_C	312	65524	Rollip7035_MP	318	80038	Quantum_R	35
65391	Accessories	235	65460	Rollip35_C	312	65525	Rollip60_MS	315	80039	Quantum_R	35
65392	Opti-pole	667	65461	Rollip70_C	312	65526	Rollip60_MS	315	80040	Quantum_R	35

codes index

CODE	Product	Page	CODE	Product	Page	CODE	Product	Page	CODE	Product	Page
80041	Quantum_R	35	80365	Loro_QJ	77	80446	Suelo_R	564	80591	Epitax	61
80042	Quantum_R	35	80366	Loro_QJ	77	80447	Suelo_R	564	80592	Epitax	61
80043	Quantum_R	35	80367	Loro_QJ	77	80448	Suelo_R	564	80593	Shaker	801
80044	Quantum_R	35	80368	Loro_QJ	77	80449	Suelo_R Pro	564	80594	Shaker	801
80045	Quantum_R	35	80369	Loro_QJ	77	80450	Suelo_R Pro	564	80595	Epitax	61
80046	Quantum_R	35	80370	Loro_RJ	73	80451	Suelo_R Pro	564	80596	Epitax	61
80047	Quantum_RJ	36	80371	Loro_RJ	73	80452	Suelo_R Pro	564	80597	Shaker	801
80048	Quantum_RJ	36	80372	Loro_RJ	73	80453	Suelo_R Pro	564	80598	Shaker	801
80049	Quantum_RJ	36	80373	Loro_RJ	73	80454	Suelo_R Pro	564	80599	Epitax	62
80050	Quantum_RJ	36	80374	Loro_RJ	73	80455	Suelo_RJ	565	80600	Epitax	62
80051	Quantum_RJ	36	80375	Loro_RJ	73	80456	Suelo_RJ	565	80603	Epitax	62
80052	Quantum_RJ	36	80376	Loro_RJ	73	80457	Suelo_RJ	565	80604	Epitax	62
80053	Quantum_RJ	36	80377	Loro_RJ	73	80476	Vos_QJ	28	80605	Envelope_1	520
80054	Quantum_RJ	36	80383	Periskop	798	80477	Vos_QJ	28	80607	Suelo_RX	574
80055	Quantum_RJ	36	80384	Periskop	798	80478	Vos_QJ	28	80608	Suelo_RX	574
80056	Quantum_RJ	36	80385	Periskop	798	80479	Vos_QJ	28	80609	Suelo_RX	575
80057	Quantum_RJ	36	80386	Periskop	798	80488	Vos_QJ	28	80610	Suelo_RX	575
80058	Quantum_RJ	36	80387	Illuminator	154	80489	Vos_QJ	28	80611	Suelo_RX Pro	574
80059	Quantum_RJ	36	80388	Illuminator	154	80490	Vos_QJ	28	80612	Suelo_RX Pro	574
80060	Quantum_RJ	36	80389	Illuminator	154	80491	Vos_QJ	28	80613	Suelo_RXJ	575
80061	Quantum_RJ	36	80390	Illuminator	154	80546	Suelo_R	566	80614	Suelo_RX	576
80062	Quantum_RJ	36	80391	Rubber 2D	891	80547	Suelo_R	566	80615	Suelo_RX	576
80063	Quantum_RJ	36	80392	Rubber 2D	891	80548	Suelo_RX	570	80616	Suelo_RX	576
80064	Quantum_RJ	36	80393	Rubber 2D	891	80549	Suelo_RX	570	80617	Suelo_RXJ	576
80065	Quantum_RJ	36	80394	Rubber 3D	892	80550	Suelo_R	566	80618	Portik_Q	479
80066	Quantum_RJ	36	80395	Rubber 3D	892	80551	Suelo_R	566	80619	Portik_Q	479
80067	Quantum_RJ	36	80396	Rubber 3D	892	80552	Suelo_RX	570	80620	Portik_Q	479
80068	Quantum_RJ	36	80397	Rubber 3D	892	80553	Suelo_RX	570	80621	Portik_Q	479
80069	Quantum_RJ	36	80398	Rubber 3D	892	80554	Suelo_R	566	80622	Portik_Q	479
80070	Quantum_RJ	36	80399	Rubber 3D	892	80555	Suelo_R	566	80623	Portik_Q	479
80071	Quantum_RJ	37	80400	Rubber 3D	892	80556	Suelo_RX	571	80624	Portik_Q	479
80072	Quantum_RJ	37	80401	Rubber 3D	892	80557	Suelo_RX	571	80625	Portik_Q	479
80073	Quantum_RJ	37	80402	Rubber 3D	892	80558	Suelo_R Pro	568	80630	Epitax	60
80074	Quantum_RJ	37	80403	Rubber 3D RGBW	892	80559	Suelo_R Pro	568	80631	Epitax	60
80075	Quantum_RJ	37	80404	Rubber 3D RGBW	892	80560	Suelo_R Pro	568	80632	Epitax	60
80076	Quantum_RJ	37	80409	Rubber 2D	891	80561	Suelo_RX Pro	571	80633	Epitax	60
80105	AntonX	105	80410	Rubber 2D	891	80562	Suelo_RX Pro	571	80634	Epitax	60
80106	AntonX	105	80411	Rubber 2D	891	80563	Suelo_RX Pro	571	80635	Epitax	60
80107	AntonX	105	80412	Rubber 2D	891	80564	Suelo_R Pro	568	80636	Epitax	60
80108	AntonX	105	80413	Rubber 2D	891	80565	Suelo_R Pro	568	80637	Epitax	60
80109	Cob40_RJ	87	80414	Rubber 2D	891	80566	Suelo_R Pro	568	80638	Epitax	61
80110	Cob40_RJ	87	80415	Rubber 3D_PRO	880	80567	Suelo_RX Pro	571	80639	Epitax	61
80244	Cob40_R	86	80416	Rubber 3D_PRO	880	80568	Suelo_RX Pro	571	80640	Epitax	61
80245	Cob40_R	86	80417	Rubber 3D_PRO	880	80569	Suelo_RX Pro	571	80641	Epitax	61
80314	Nautilus_RP	868			881	80570	Suelo_R Pro	568	80642	Epitax_J	63
80338	Illuminator	152	80418	Accessories	894	80571	Suelo_R Pro	568	80643	Epitax_J	63
80346	Loro_QJ	76			881	80572	Suelo_R Pro	568	80644	Epitax_J	63
80347	Loro_QJ	76	80419	Accessories	894	80573	Suelo_RX Pro	572	80645	Epitax_J	63
80348	Loro_QJ	76			562	80574	Suelo_RX Pro	572	80646	Epitax_J	63
80349	Loro_QJ	76	80432	Suelo_R	871	80575	Suelo_RX Pro	572	80647	Epitax_J	63
80350	Loro_QJ	76			562	80576	Suelo_RX Pro	569	80648	Epitax_J	63
80351	Loro_QJ	76	80433	Suelo_R Pro	871	80577	Suelo_RXJ	572	80649	Epitax_J	63
80352	Loro_QJ	76			562	80578	Suelo_RJ Pro	569	80658	Loro_Q	75
80353	Loro_QJ	76	80434	Suelo_R Pro	871	80579	Suelo_RXJ	572	80659	Loro_Q	75
80354	Loro_QJ	76			570	80580	Suelo_RJ Pro	569	80660	Loro_Q	75
80355	Loro_QJ	76	80435	Suelo_RX Pro	570	80581	Suelo_RXJ	572	80661	Loro_Q	75
80356	Loro_QJ	76	80436	Suelo_RX Pro	570	80582	Orma_I	604	80670	Loro_R	71
80357	Loro_QJ	76	80437	Suelo_RX Pro	570	80583	Orma_I	604	80671	Loro_R	71
80358	Loro_QJ	76	80438	Suelo_RX Pro	570	80584	Orma_I	604	80672	Loro_R	71
80359	Loro_QJ	76	80439	Suelo_R Pro	563	80585	Orma_I	604	80673	Loro_R	71
80360	Loro_QJ	76	80440	Suelo_R Pro	563	80586	Orma_I	604	80688	Loro_Q	75
80361	Loro_QJ	76	80441	Suelo_R Pro	563	80587	Orma_I	604	80689	Loro_Q	75
80362	Loro_QJ	77	80442	Suelo_R Pro	563	80588	Orma_I	604	80690	Loro_Q	75
80363	Loro_QJ	77	80443	Suelo_R	564	80589	Orma_I	604	80691	Loro_Q	75
80364	Loro_QJ	77	80444	Suelo_R	564	80590	Orma_I	604	80702	Loro_R	71
			80445	Suelo_R	564						

CODE	Product	Page	CODE	Product	Page	CODE	Product	Page	CODE	Product	Page
80703	Loro_R	71	80821	Loro_Q	74	80894	Loro_QJ	76	81063	Track system	202
80704	Loro_R	71	80822	Loro_Q	74	80895	Loro_QJ	76	81064	Track system	202
80705	Loro_R	71	80823	Loro_Q	74	80896	Loro_QJ	76	81066	Track system	202
80706	Loro_RJ	72	80824	Loro_Q	74	80897	Loro_QJ	76	81067	Track system	202
80707	Loro_RJ	72	80825	Loro_Q	74	80898	Loro_QJ	76	81069	Track system	203
80708	Loro_RJ	72	80826	Loro_Q	74	80899	Loro_QJ	77	81070	Track system	203
80709	Loro_RJ	72	80827	Loro_Q	74	80900	Loro_QJ	77	81072	Track system	203
80710	Loro_RJ	72	80828	Loro_Q	74	80901	Loro_QJ	77	81073	Track system	203
80711	Loro_RJ	72	80829	Loro_Q	74	80902	Loro_QJ	77	81075	Track system	203
80712	Loro_RJ	72	80830	Loro_Q	74	80903	Loro_QJ	77	81076	Track system	203
80713	Loro_RJ	72	80831	Loro_Q	74	80904	Loro_QJ	77	81078	Track system	203
80722	Vos_R	21	80832	Loro_Q	74	80905	Loro_QJ	77	81079	Track system	203
80723	Vos_R	21	80833	Loro_Q	74	80906	Loro_QJ	77	81081	Track system	203
80724	Vos_R	21	80834	Loro_Q	74	80981	Track system	202	81082	Track system	203
80725	Vos_R	21	80835	Loro_Q	75	80982	Track system	202	81084	Track system	203
80726	Vos_Q	27	80836	Loro_Q	75	80983	Track system	202	81085	Track system	203
80727	Vos_Q	27	80837	Loro_Q	75	80984	Track system	202	81086	Track system	203
80728	Vos_Q	27	80838	Loro_Q	75	80985	Track system	202	81087	Track system	203
80729	Vos_Q	27	80839	Loro_Q	75	80986	Track system	202	81088	Track system	203
80730	Rubber 3D_PRO	880	80840	Loro_Q	75	80990	Track system	202	81089	Suelo_R	564
80731	Rubber 3D_PRO	880	80841	Loro_Q	75	80991	Track system	202	81090	Suelo_R	564
80733	Accessories	881	80842	Loro_Q	75	80992	Track system	202	81091	Track system	203
		894	80843	Loro_RJ	72	80993	Track system	202	81093	Track system	203
80734	Accessories	881	80844	Loro_RJ	72	80994	Track system	202	81094	Track system	203
		894	80845	Loro_RJ	72	80995	Track system	202	81095	Track system	203
80744	Epitax	60	80846	Loro_RJ	72	80999	Track system	202	81097	Bond_PRO	661
80745	Epitax	60	80847	Loro_RJ	72	81000	Track system	202	81098	Bond_PRO	661
80746	Epitax	60	80848	Loro_RJ	72	81002	Track system	202	81099	Bond_PRO	661
80747	Epitax	60	80849	Loro_RJ	72	81003	Track system	202	81100	Bond_PRO	661
80748	Epitax	61	80850	Loro_RJ	72	81005	Track system	203	81101	Bond_PRO	661
80749	Epitax	61	80851	Loro_RJ	72	81006	Track system	203	81102	Bond_PRO	661
80750	Epitax	61	80852	Loro_RJ	72	81007	Track system	203	81103	Bond_PRO	661
80751	Epitax	61	80853	Loro_RJ	72	81008	Track system	203	81104	Bond_PRO	661
80752	Epitax	62	80854	Loro_RJ	72	81009	Track system	203	81105	Bond_PRO	661
80753	Epitax	62	80855	Loro_RJ	72	81012	Track system	203	81106	Bond_PRO	661
80757	Epitax_J	63	80856	Loro_RJ	72	81013	Track system	203	81107	Bond_PRO	661
80758	Epitax_J	63	80857	Loro_RJ	72	81014	Track system	203	81108	Bond_PRO	661
80759	Epitax_J	63	80858	Loro_RJ	72	81015	Track system	203	81109	Suelo_RX	574
80760	Epitax_J	63	80859	Loro_RJ	73	81018	Track system	203	81110	Suelo_RX	575
80787	Loro_R	70	80860	Loro_RJ	73	81019	Track system	203	81111	Suelo_RXJ	575
80788	Loro_R	70	80861	Loro_RJ	73	81021	Track system	203	81114	Vos_RJ	22
80789	Loro_R	70	80862	Loro_RJ	73	81022	Track system	203	81115	Vos_RJ	22
80790	Loro_R	70	80863	Loro_RJ	73	81024	Track system	203	81118	Vos_RJ	22
80791	Loro_R	70	80864	Loro_RJ	73	81025	Track system	203	81119	Vos_RJ	22
80792	Loro_R	70	80865	Loro_RJ	73	81026	Track system	203	81122	Vos_RJ	22
80793	Loro_R	70	80866	Loro_RJ	73	81033	Track system	202	81123	Vos_RJ	22
80794	Loro_R	70	80867	Loro_RJ	73	81034	Track system	202	81126	Vos_RJ	22
80795	Loro_R	70	80868	Loro_RJ	73	81036	Track system	202	81127	Vos_RJ	22
80796	Loro_R	70	80869	Loro_RJ	73	81037	Track system	202	81160	Periskop Narrow	795
80797	Loro_R	70	80870	Loro_RJ	73	81039	Track system	202	81161	Periskop Narrow	795
80798	Loro_R	70	80871	Loro_RJ	73	81040	Track system	202	81162	Periskop Narrow	795
80799	Loro_R	70	80872	Loro_RJ	73	81042	Track system	202	81163	Periskop Narrow	795
80800	Loro_R	70	80873	Loro_RJ	73	81043	Track system	202	81164	Periskop Narrow	796
80801	Loro_R	70	80874	Loro_RJ	73	81045	Track system	202	81165	Periskop Narrow	796
80802	Loro_R	70	80877	Loro_QJ	76	81046	Track system	202	81166	Periskop Narrow	796
80803	Loro_R	71	80883	Loro_QJ	76	81048	Track system	202	81167	Periskop Narrow	796
80804	Loro_R	71	80884	Loro_QJ	76	81049	Track system	202	81168	Periskop Narrow	798
80805	Loro_R	71	80885	Loro_QJ	76	81051	Track system	202	81169	Periskop Narrow	798
80806	Loro_R	71	80886	Loro_QJ	76	81052	Track system	202	81170	Periskop Narrow	798
80807	Loro_R	71	80887	Loro_QJ	76	81054	Track system	202	81171	Periskop Narrow	798
80808	Loro_R	71	80888	Loro_QJ	76	81055	Track system	202	81172	Orma_I	604
80809	Loro_R	71	80889	Loro_QJ	76	81057	Track system	202	81173	Orma_I	604
80810	Loro_R	71	80890	Loro_QJ	76	81058	Track system	202	81174	Orma_I	604
80819	Loro_Q	74	80891	Loro_QJ	76	81060	Track system	202	81175	Orma_I	605
80820	Loro_Q	74	80892	Loro_QJ	76	81061	Track system	202	81176	Orma_I	605
			80893	Loro_QJ	76						

codes index

CODE	Product	Page	CODE	Product	Page	CODE	Product	Page	CODE	Product	Page
81177	Orma_I	605	81242	Orma_CJ	472	81308	Gardener	804	81449	Archiline PRO_W	720
81178	Orma_I	605	81243	Orma_CJ	473	81309	Gardener	804	81450	Archiline PRO_W	720
81179	Orma_I	605	81244	Orma_CJ	473	81310	Gardener	804	81451	Archiline PRO_W	720
81180	Orma_I	605	81245	Orma_CJ	474	81311	Gardener	804	81452	Archiline PRO_W	720
81181	Orma_A	598	81246	Orma_CJ	474	81312	Gardener	804	81453	Xenia_A	732
81182	Orma_A	598	81247	Ice-cut	378	81313	Gardener	804	81454	Xenia_A	732
81183	Orma_A	598	81248	Ice-cut	378	81314	Gardener	804	81455	Xenia_A	732
81184	Orma_A	598	81249	Ice-cut	378	81315	Gardener	804	81456	Xenia_A	732
81185	Orma_A	598	81250	Ice-cut	378	81320	Vos_RJ	22	81457	Xenia_A	732
81186	Orma_A	598	81251	Ice-cut	378	81321	Orma_I	604	81458	Xenia_A	732
81187	Orma_A	598	81252	Ice-cut	378	81322	Orma_A	598	81459	Xenia_A	732
81188	Orma_A	598	81253	Ice-cut	378	81323	Step	387	81460	Xenia_A	732
81189	Orma_A	598	81254	Ice-cut	378	81324	Step	387	81461	Xenia_AL	733
81190	Orma_A	598	81255	Ice-Cut66_F	763	81325	Step	387	81462	Xenia_AL	733
81191	Orma_A	598	81256	Ice-Cut66_F	763	81326	Step	387	81463	Xenia_AL	733
81192	Orma_A	598	81257	Ice-Cut66_F	763	81327	Step	387	81464	Xenia_AL	733
81193	Orma_A	599	81258	Warp_RJ	50	81328	Paseo_L	748	81465	Xenia_A PRO	734
81194	Orma_A	599	81259	Warp_RJ	50	81329	Paseo_L	748	81466	Xenia_A PRO	734
81195	Orma_A	599	81260	Warp_RJ	50	81330	Paseo_L	748	81467	Xenia_A PRO	734
81196	Orma_A	599	81261	Warp_RJ	50	81331	Paseo_L	748	81468	Xenia_A PRO	734
81197	Orma_A	599	81262	Warp_RJ	50	81332	Paseo_L	748	81469	Beret_R	614
81198	Orma_A	599	81263	Warp_RJ	50	81333	Paseo_L	748	81470	Beret_R	614
81199	Orma_IJ	606	81264	Warp_RJ	50	81337	Paseo_PIXEL	851	81471	Beret_X	614
81200	Orma_IJ	606	81265	Warp_RJ	50	81338	Paseo_PIXEL	851	81473	Clivo_2	811
81201	Orma_IJ	606	81266	Vos_RJ	22	81339	Envelope_W	520	81474	Clivo_SL	811
81202	Orma_IJ	606	81267	Vos_RJ	22	81340	Envelope_W	520	81475	Suelo_Telescopic	580
81203	Orma_IJ	607	81268	Vos_RJ	22	81341	Envelope_W	520	81476	Suelo_Telescopic	580
81204	Orma_IJ	607	81269	Vos_RJ	22	81342	Envelope_W	520	81477	Giotto_P	82
81205	Orma_AJ	600	81270	Vos_QJ	28	81343	Envelope_W	521	81478	Giotto_P	82
81206	Orma_AJ	600	81271	Vos_QJ	28	81344	Envelope_W	521	81479	Giotto_P	82
81207	Orma_AJ	600	81272	Vos_QJ	28	81351	Cob40_R	86	81480	Giotto_P	82
81208	Orma_AJ	600	81273	Vos_QJ	28	81352	Cob40_R	86	81481	Warp_R	43
81209	Orma_AJ	601	81274	Vos_RJ	22	81367	Periskop	798	81482	Warp_R	43
81210	Orma_AJ	601	81275	Vos_RJ	22	81368	Periskop	798	81483	Archiline_Twin	823
81211	Orma_IL	608	81276	Vos_RJ	22	81369	Periskop	798	81484	Archiline_Twin	823
81212	Orma_IL	608	81277	Vos_RJ	22	81370	Periskop	798	81485	Warp_R	46
81213	Orma_IL	608	81278	Vos_QJ	28	81371	Portik_R	478	81486	Warp_R	46
81214	Orma_IL	608	81279	Vos_QJ	28	81372	Portik_R	478	81487	Warp_R	46
81215	Orma_IL	609	81280	Vos_QJ	28	81373	Portik_R	478	81488	Warp_R	46
81216	Orma_IL	609	81281	Vos_QJ	28	81374	Portik_R	478	81489	Warp_R	46
81217	Orma_AL	602	81282	Vos_RJ	22	81375	Portik_Q	479	81490	Warp_R	46
81218	Orma_AL	602	81283	Vos_RJ	22	81376	Portik_Q	479	81491	Warp_R	46
81219	Orma_AL	602	81285	Vos_RJ	22	81377	Portik_Q	479	81492	Warp_R	46
81220	Orma_AL	602	81286	Vos_QJ	28	81378	Portik_Q	479	81493	Periskop RGBW	795
81221	Orma_AL	603	81287	Vos_QJ	28			346	81494	Periskop RGBW	795
81222	Orma_AL	603	81288	Vos_QJ	28	81410	Ink system Cables	350	81495	Periskop RGBW	795
81223	Orma_C	472	81289	Vos_QJ	28			346	81496	Periskop RGBW	795
81224	Orma_C	472	81290	Envelope_W	521	81411	Ink system Cables	350	81497	Periskop RGBW	796
81225	Orma_C	472	81291	Envelope_W	521			356	81498	Periskop RGBW	796
81226	Orma_C	472	81292	Envelope_W	521	81413	Accessories	356	81499	Periskop RGBW	796
81227	Orma_C	472	81293	Envelope_W	521	81414	Accessories	356	81500	Periskop RGBW	796
81228	Orma_C	472	81294	Envelope_W	521	81416	Accessories	356	81501	Gardener RGBW	805
81229	Orma_C	473	81295	Envelope_W	521	81417	Accessories	356	81502	Gardener RGBW	805
81230	Orma_C	473	81296	Optiwall	515	81418	Accessories	358	81503	Gardener RGBW	805
81231	Orma_C	473	81297	Optiwall	515	81419	Accessories	358	81504	Gardener RGBW	805
81232	Orma_C	473	81298	Optiwall	515	81420	Accessories	358	81505	Gardener RGBW	805
81233	Orma_C	473	81299	Optiwall	515	81421	Accessories	358	81506	Gardener RGBW	805
81234	Orma_C	473	81300	Optiwall	515	81422	Accessories	359	81507	Gardener RGBW	805
81235	Orma_C	474	81301	Optiwall	515	81423	Accessories	359	81508	Gardener RGBW	805
81236	Orma_C	474	81302	Optiwall	515	81424	Accessories	356	81509	Envelope_W	521
81237	Orma_C	474	81303	Optiwall	515	81425	Accessories	359	81510	Envelope_W	521
81238	Orma_C	474	81304	Optiwall	515	81426	Accessories	346	81511	Envelope_W	521
81239	Orma_C	474	81305	Optiwall	515	81427	Accessories	359	81512	Envelope_W	521
81240	Orma_C	474	81306	Optiwall	515	81430	Accessories	346	81513	Archiline_W	718
81241	Orma_CJ	472	81307	Optiwall	515	81447	Archiline PRO_W	720	81514	Epitax	61
						81448	Archiline PRO_W	720			

CODE	Product	Page	CODE	Product	Page	CODE	Product	Page	CODE	Product	Page
81515	Epitax	61	81603	Archiline_A	710	81674	Archiline PRO_I	714	81785	Periskop RGBW	798
81516	Epitax	62	81604	Archiline_A	710	81675	Archiline PRO_I	714	81786	Periskop RGBW	798
81517	Epitax	62	81605	Archiline_A	710	81676	Archiline PRO_I	714	81787	Periskop RGBW	798
81518	Play_Quantum	140	81606	Archiline_A	710	81677	Archiline PRO_I	714	81788	Periskop Narrow	794
81519	Play_Quantum	140	81607	Archiline_A	710	81678	Archiline PRO_I	714	81789	Periskop Narrow	794
81520	Play_Quantum	140	81608	Archiline_A	710	81679	Archiline PRO_I	714	81790	Periskop Narrow	794
81521	Play_Quantum	140	81609	Archiline_A	710	81680	Archiline PRO_I	714	81791	Periskop Narrow	794
81522	Play_S	140	81610	Archiline_W	718	81687	Xenia_A PRO	734	81808	Pound_T	173
81526	Play_Navata	140	81611	Archiline_W	718	81688	Xenia_A PRO	734	81809	Pound_T	173
81527	Play_Navata	140	81612	Archiline_W	718	81689	Xenia_A PRO	734	81810	Pound_T	173
81528	Play_Navata	140	81613	Archiline_W	718	81690	Xenia_A PRO	734	81811	Pound_T	173
81529	Play_Navata	140	81614	Archiline_W	718	81691	Footpad Flat	639	81812	Pound_T	173
81530	Play_Navata	140	81615	Archiline_W	718	81692	Suelo_I Focus	581	81813	Pound_T	173
81531	Play_Navata	140	81616	Archiline_W	718	81693	Suelo Focus	581	81814	Optus_T	191
81532	Play_Navata	140	81617	Archiline_W	718	81695	Xenia_W	726	81815	Optus_T	191
81533	Play_Navata	140	81618	Archiline_W	718	81696	Xenia_W	726	81816	Optus_T	191
81534	Paly_P	141	81619	Suelo_RDX	577	81702	Xenia_W PRO	729	81817	Optus_T	191
81535	Paly_P	141	81620	Suelo_RDX	577	81703	Xenia_W PRO	729	81818	Optus_T	191
81536	Paly_P	141	81621	Xenia_A	732	81704	Xenia_W PRO	729	81819	Optus_T	191
81537	Paly_P	141	81622	Xenia_A	732	81705	Xenia_W PRO	729	81828	Electronics	957
81538	Play_Giotto	141	81623	Xenia_AL	733	81706	Xenia_W PRO	729	81829	Electronics	957
81539	Play_Giotto	141	81624	Xenia_A PRO	734	81713	Xenia_W PRO	729	81830	Electronics	957
81540	Play_Giotto	141	81625	Pound_T	172	81714	Xenia_W PRO	729	81831	Electronics	957
81541	Play_Giotto	141	81626	Pound_T	172	81715	Xenia_W PRO	729	81835	Electronics	957
81542	Periskop	798	81627	Pound_T	172	81716	Xenia_W PRO	729	81836	Electronics	957
81543	Periskop	798	81628	Pound_T	172	81717	Suelo_R	566	81838	Guardian	465
81544	Periskop	798	81629	Pound_T	172	81718	Suelo_RX	570	81839	Guardian	465
81545	Periskop	798	81630	Pound_T	172	81719	Suelo_RX	574	81840	Guardian_J	465
81546	Periskop	798	81631	Pound_T	172	81720	Iris67 Elliptic	815	81841	Guardian	466
81547	Periskop	798	81632	Pound_T	172	81721	Iris67 Elliptic	815	81842	Guardian	466
81548	Periskop	798	81633	Pound_T	172	81722	Iris67 Elliptic	815	81844	Guardian	466
81549	Periskop	798	81634	Pound_T	172	81723	Iris67 Elliptic	815	81845	Guardian	466
81550	Play_Quantum	140	81635	Pound_T	172	81724	Iris67 Elliptic	815	81846	Guardian	466
81551	Play_Quantum	140	81636	Pound_T	172	81725	Iris67 Elliptic	815	81848	Guardian	466
81552	Play_Quantum	140	81637	Pound_T	172	81726	Iris67 Elliptic	815	81849	Guardian_J	466
81553	Play_Quantum	140	81638	Pound_T	172	81727	Iris67 Elliptic	815	81850	Guardian_J	466
81574	Vedette_Q	493	81639	Pound_T	172	81728	Iris67 Elliptic	815	81851	Portik_R	478
81575	Vedette_Q	493	81640	Pound_T	172	81729	Iris67 Elliptic	815	81852	Portik_R	478
81576	Vedette_Q	493	81641	Pound_T	172	81730	Iris67 Elliptic	815	81853	Portik_R	478
81577	Vedette_Q	493	81642	Pound_T	172	81731	Iris67 Elliptic	815	81854	Portik_R	478
81578	Vedette_Q	493	81643	Optus_T	190	81732	Suelo_RX	576	81855	Portik_R	478
81579	Vedette_Q	493	81644	Optus_T	190	81733	Suelo_RX	576	81856	Portik_R	478
81580	Vedette_Q	493	81645	Optus_T	190	81734	Suelo_RX	576	81857	Portik_R	478
81581	Vedette_Q	493	81646	Optus_T	190	81735	Suelo_RXJ	576	81858	Portik_R	478
81582	Vedette_Q	493	81647	Optus_T	190	81736	Alcor_Q	628	81865	Rollip60_MS	315
81583	Vedette_Q	493	81648	Optus_T	190	81737	Suelo_RX	576	81866	Rollip60_MS	315
81584	Vedette_Q	493	81655	Optus_T	190	81740	Suelo_RX	574	81867	Guardian	467
81585	Vedette_Q	493	81656	Optus_T	190	81741	Suelo_RX	574	81868	Guardian	467
81586	Vedette_Q	493	81657	Optus_T	190	81742	Suelo_RX	575	81870	Guardian	467
81587	Vedette_Q	493	81658	Optus_T	190	81743	Suelo_RX	575	81871	Guardian	467
81588	Vedette_Q	493	81659	Optus_T	190	81744	Suelo_RX Pro	574	81872	Guardian	467
81589	Vedette_Q	493	81660	Optus_T	190	81745	Suelo_RX Pro	574	81874	Guardian	467
81590	Archiline_A	710	81661	Optus_EX	147	81746	Suelo_RX	576	81875	Guardian_J	467
81591	Archiline_F	706	81662	Optus_EX	147	81747	Suelo_RX	576	81876	Guardian_J	467
81592	Archiline_F	706	81663	Optus_EX	147	81748	Suelo_RX	576	81877	Portik_R	478
81593	Archiline_F	706	81664	Optus_EX	147	81749	Suelo_RX	576	81878	Portik_R	478
81594	Archiline_F	706	81665	Optus_EX	147	81750	Alcor_Q	628	81879	Portik_R	478
81595	Archiline_F	706	81666	Optus_EX	147	81751	Alcor_Q	628	81880	Portik_R	478
81596	Archiline_F	706	81667	Optus_EX	147	81752	Pound_T	173	81881	Portik_Q	479
81597	Archiline_I	712	81668	Optus_EX	147	81753	Pound_T	173	81882	Portik_Q	479
81598	Archiline_I	712	81669	Optus_EX	147	81754	Pound_T	173	81883	Portik_Q	479
81599	Archiline_I	712	81670	Optus_EX	147	81755	Pound_T	173	81884	Portik_Q	479
81600	Archiline_I	712	81671	Optus_EX	147	81756	Pound_T	173	81885	Portik_R	478
81601	Archiline_I	712	81672	Optus_EX	147	81757	Pound_T	173	81886	Portik_R	478
81602	Archiline_I	712	81673	Archiline PRO_I	714	81784	Periskop RGBW	798	81887	Portik_R	478

codes index

CODE	Product	Page	CODE	Product	Page	CODE	Product	Page	CODE	Product	Page
81888	Portik_R	478	81988	Pound Focus	176	82107	Pound Focus	178	82251	Optus_Ww	194
81889	Portik_Q	479	81989	Pound Focus	176	82108	Pound Focus	178	82252	Optus_Ww	194
81890	Portik_Q	479	81990	Pound Focus	176	82109	Pound Focus	178	82253	Optus_Ww	194
81891	Portik_Q	479	81991	Pound Focus	176	82110	Pound Focus	178	82254	Optus_Ww	194
81892	Portik_Q	479	81992	Pound Focus	176	82113	Pound Shaper	179	82257	RollipPRO	304
81893	Guardian	465	81995	Pound_Wall	273	82114	Pound Shaper Dist.	179	82258	Skylum_Q	254
81894	Guardian	465	81996	Pound_Wall	273	82115	Pound Shaper Dist.	179	82259	Skylum_Q	254
81895	Guardian_J	465	81997	Pound_Wall	273	82116	Pound Shaper	179	82260	Skylum_Q	254
81896	Guardian	466	81998	Pound_Wall	273	82117	Pound Shaper	181	82261	Skylum_Q	254
81897	Guardian	466	81999	Pound_Wall	273	82118	Pound Shaper	181	82262	Skylum_Q	254
81899	Guardian	466	82000	Pound_Wall	273	82119	Pound Shaper	181	82263	Skylum_Q	254
81900	Guardian	466	82003	Pound_S	272	82120	Pound Shaper	181	82264	Tour_Cell_C	233
81901	Guardian	466	82004	Pound_S	272	82121	Pound Shaper Dist.	181	82265	Tour_Cell_C	233
81903	Guardian	466	82005	Pound_S	272	82122	Pound Shaper Dist.	181	82266	Suelo_Brass	582
81904	Guardian_J	466	82006	Pound_S	272	82135	Rubber 2D	891	82267	Suelo_Brass	582
81905	Guardian_J	466	82007	Pound_S	272	82136	Rubber 2D	891	82268	Suelo_Brass	582
81906	Guardian	467	82008	Pound_S	272	82137	Rubber 2D	891	82269	Suelo_Brass	582
81907	Guardian	467	82055	Pound_Wall Focus	273	82138	Rubber 2D	891	82290	Clear_MC	327
81909	Guardian	467	82056	Pound_Wall Focus	273	82139	Rubber 2D	891	82291	Clear_MC	327
81910	Guardian	467	82057	Pound_Wall Focus	273	82140	Rubber 2D	891	82292	Clear_MC	327
81911	Guardian	467	82058	Pound_Wall Focus	273	82141	Rubber 2D	891	82293	Clear_MC	327
81913	Guardian	467	82059	Pound_Wall Focus	273	82142	Rubber 2D	891	82294	Clear_MC	327
81914	Guardian_J	467	82060	Pound_Wall Focus	273	82143	Rubber 2D	891	82295	Clear_MC	327
81915	Guardian_J	467	82063	Pound_S Focus	272	82147	Rubber 2D_mini	890	82298	Tour_Cell_P	242
81916	Guardian	465	82064	Pound_S Focus	272	82148	Rubber 2D_mini	890	82299	Tour_Cell_P	242
81917	Guardian	465	82065	Pound_S Focus	272	82149	Rubber 2D_mini	890	82300	Tour_Cell_P	242
81918	Guardian_J	465	82066	Pound_S Focus	272	82150	Rubber 2D_mini	890	82301	Tour_Cell_P	242
81919	Guardian	466	82067	Pound_S Focus	272	82151	Rubber 2D_mini	890	82302	Archiline_FJ	707
81920	Guardian	466	82068	Pound_S Focus	272	82152	Rubber 2D_mini	890	82303	Archiline_FJ	707
81922	Guardian	466	82071	Pound Shaper	179	82153	Rubber 2D_mini	890	82304	Archiline_FJ	707
81923	Guardian	466	82072	Pound Shaper Dist.	179	82154	Rubber 2D_mini	890	82305	Archiline_FJ	707
81924	Guardian	466	82073	Pound Shaper Dist.	179	82155	Rubber 2D_mini	890	82306	Archiline_FJ	707
81926	Guardian	466	82074	Pound Shaper	179	82208	Rubber 3D	892	82307	Archiline_FJ	707
81927	Guardian_J	466	82075	Giotto_RF	83	82211	Rubber 3D	892	82308	Archiline_IJ	713
81928	Guardian_J	466	82076	Giotto_RF	83	82216	Rubber 3D Optics	893	82309	Archiline_IJ	713
81929	Guardian	467	82077	Giotto_RF	83	82217	Rubber 3D Optics	893	82310	Archiline_IJ	713
81930	Guardian	467	82078	Giotto_RF	83	82218	Rubber 3D Optics	893	82311	Archiline_IJ	713
81932	Guardian	467	82079	Rollip60_MS	315	82219	Rubber 3D Optics	893	82312	Archiline_IJ	713
81933	Guardian	467	82080	Rollip60_MS	315	82220	Rubber 3D Optics	893	82313	Archiline_IJ	713
81934	Guardian	467	82081	Rollip60_MS	315	82221	Rubber 3D Optics	893	82326	Xenia_A PRO MicroL.	739
81936	Guardian	467	82082	Rollip60_MS	315	82222	Fasim	619	82327	Xenia_A PRO MicroL.	739
81937	Guardian_J	467	82083	Rollip60_MS	315	82223	Fasim	619	82328	Xenia_A PRO MicroL.	739
81938	Guardian_J	467	82084	Rollip60_MS	315	82224	Fasim	619	82329	Xenia_A PRO MicroL.	739
81943	Fasim	620	82085	Rollip60_MP	320	82227	Pound_T	175	82330	Xenia_A PRO MicroL.	739
81944	Fasim_J	620	82086	Rollip60_MP	320	82228	Pound_T	175	82331	Xenia_A PRO MicroL.	739
81945	Narcissus	807	82087	Rollip60_MP	320	82229	Pound_T	175	82332	Xenia_A PRO MicroL.	739
81946	Prolamp	821	82088	Rollip60_MP	320	82230	Pound_T	175	82333	Xenia_A PRO MicroL.	739
81947	Prolamp	821	82089	Rollip60_MP	320	82231	Pound_T	175	82334	Xenia_A PRO MicroL.	739
81948	Prolamp	821	82090	Rollip60_MP	320	82232	Pound_T	175	82339	Illuminator	153
81949	Prolamp RGBW	821	82091	Rollip60_MP	320	82235	Optus_T	190	82340	Illuminator	153
81950	Prolamp RGBW	821	82092	Rollip60_MP	320	82236	Optus_T	190	82341	Illuminator	154
81951	Prolamp RGBW	821	82093	Rollip60_MP	320	82237	Optus_T	190	82342	Illuminator	154
81954	Pound_T SuperSpot	172	82094	Rollip60_MP	320	82238	Optus_T	190	82353	Pound_BC	182
81955	Pound_T SuperSpot	172	82095	Rollip60_MP	320	82239	Optus_T	190	82354	Pound_BC	182
81956	Ribbon Plus	900	82096	Rollip60_MP	320	82240	Optus_T	190	82355	Pound_BC	182
81957	Ribbon Plus	900	82097	Rollip60_PC	323	82241	Optus_T	193	82356	Pound_BC	182
81958	Ribbon Plus	900	82098	Rollip60_PC	323	82242	Optus_T	193	82357	Pound_BC	182
81959	PU_C Plus	902	82099	Rollip60_PC	323	82243	Optus_T	193	82358	Pound_BC	182
81960	PU_C Plus	902	82100	Rollip60_PC	323	82244	Optus_T	193	82359	Pound_BS	183
81961	PU_C Plus	902	82101	Rollip60_MP	320	82245	Optus_T	193	82360	Pound_BS	183
81962	PU_C Plus	902	82102	Rollip60_MP	320	82246	Optus_T	193	82361	Pound_BS	183
81963	PU_C Plus	902	82103	Rollip60_MP	320	82247	Optus_Ww	194	82362	Pound_BS	183
81964	PU_C Plus	902	82104	Rollip60_MP	320	82248	Optus_Ww	194	82363	Pound_BS	183
81965	PU_C PLUS RGBW	903	82105	Pound Focus	178	82249	Optus_Ww	194	82364	Pound_BS	183
81987	Pound Focus	176	82106	Pound Focus	178	82250	Optus_Ww	194	82365	Pound_BS	183

CODE	Product	Page	CODE	Product	Page	CODE	Product	Page	CODE	Product	Page
82366	Pound_BS	183	82458	Orma_IJ	607	82529	Suelo_R Pro	563	82605	Cell_SWw	277
82367	Pound_BS	183	82459	Orma_IJ	607	82530	Suelo_R Pro	563	82606	Cell_SWw	277
82368	Pound_BS	183	82460	Orma_AJ	600	82531	Suelo_R Pro	563	82607	Pound_T	173
82369	Pound_BS	183	82461	Orma_AJ	600	82532	Suelo_R Pro	563	82608	Pound_T	173
82370	Pound_BS	183	82462	Orma_AJ	601	82533	Suelo_RJ	565	82609	Pound_T	173
82371	Optus_T	193	82463	Orma_AJ	601	82534	Suelo_RJ	565	82610	Pound_T	173
82372	Optus_T	193	82464	Fasim	619	82535	Suelo_R Pro	568	82611	Pound_T	173
82373	Optus_T	193	82465	Pound Shaper Dist.	181	82536	Suelo_R Pro	568	82612	Pound_T	173
82374	Optus_T	193	82466	Pound Shaper Dist.	181	82537	Suelo_R Pro	568	82619	Eyelet_R	441
82375	Optus_T	193	82467	Vos_Ww	24	82538	Suelo_RX Pro	570	82620	Eyelet_R	441
82376	Optus_T	193	82468	Vos_Ww	24	82539	Suelo_RX Pro	570	82621	Eyelet_R	441
82377	Optus_T	193	82469	Vos_Ww	24	82540	Suelo_RX Pro	570	82622	Eyelet_Q	441
82378	Optus_T	193	82470	Vos_Ww	24	82541	Suelo_RX Pro	570	82623	Eyelet_Q	441
82379	Optus_T	193	82473	Cob40_R	86	82542	Suelo_RX Pro	572	82624	Eyelet_Q	441
82380	Optus_T	193	82474	Cob40_R	86	82543	Suelo_RX Pro	572	82625	Navata Pound Sha.	211
82381	Optus_T	193	82475	Cob40_R	86	82544	Suelo_RX Pro	572	82626	Navata Pound Sha.	211
82382	Optus_T	193	82476	Cob40_R	86	82545	Suelo_RXJ	572	82627	Navata Pound Sha.D.	211
82383	Navata_Optus	210	82477	Cob40_RJ	87	82546	Suelo_RX Pro	574	82628	Navata Pound Sha.D.	211
82384	Navata_Optus	210	82478	Cob40_RJ	87	82547	Suelo_RX Pro	574	82629	Navata Pound Sha.	211
82385	Navata_Optus	210	82479	Cob40_RJ	87	82548	Suelo_RX Pro	574	82630	Navata Pound Sha.	211
82386	Navata_Optus	210	82480	Cob40_RJ	87	82549	Suelo_RX Pro	574	82631	Navata Pound Sha.D.	211
82387	Navata_Optus	210	82481	Xenia_ALF	736	82550	Suelo_RXJ	575	82632	Navata Pound Sha.D.	211
82388	Navata_Optus	210	82482	Xenia_ALF	736	82553	Xenia_AF PRO MicroL	740	82637	Astropek_Blade	637
82389	Navata_Optus	210	82483	Xenia_ALF	736	82554	Xenia_AF PRO MicroL	740	82638	Astropek_Blade	637
82390	Navata_Optus	210	82484	Xenia_ALF	736	82555	Xenia_AF PRO MicroL	740	82639	Alcor_R Blade	629
82391	Navata_Optus	210	82485	Xenia_ALF	736	82556	Xenia_AF PRO MicroL	740	82640	Alcor_R Blade	629
82392	Navata_Optus	210	82486	Xenia_AF	736	82557	Xenia_AF PRO MicroL	740	82642	MK68_R	873
82393	Navata_Optus	210	82487	Xenia_AF	736	82562	Xenia_AF PRO MicroL	740	82644	MK68_R	873
82394	Navata_Optus	210	82488	Xenia_AF	736	82563	Xenia_AF PRO MicroL	740	82646	MK68_R	873
82395	Navata_Optus	210	82489	Xenia_AF	736	82564	Xenia_AF PRO MicroL	740	82648	MK68_R	873
82396	Navata_Optus	210	82490	Xenia_AF	736	82565	Xenia_AF PRO MicroL	740	82650	MK68_Q	873
82397	Navata_Optus	210	82491	Xenia_AF	735	82570	Rollip60_MS	315	82652	MK68_Q	873
82398	Navata_Optus	210	82492	Xenia_AF	735	82571	Rollip60_MS	315	82654	MK68_Q	873
82399	Navata_Optus	210	82493	Xenia_AF	735	82572	Rollip60_MS	315	82656	MK68_Q	873
82400	Navata_Optus	210	82494	Xenia_AF	735	82573	Rollip60_MS	315	82657	Orma_F	590
82406	Pound_T	175	82495	Xenia_AF	735	82574	Rollip60_MS	315	82658	Orma_F	590
82407	Pound_T	175	82496	Xenia_AF PRO	737	82575	Rollip60_MS	315	82659	Orma_F	590
82408	Pound_T	175	82497	Xenia_AF PRO	737	82576	Rollip60_MP	320	82660	Orma_F	590
82409	Pound_T	175	82498	Xenia_AF PRO	737	82577	Rollip60_MP	320	82661	Orma_F	590
82410	Pound_T	175	82499	Xenia_AF PRO	737	82578	Rollip60_MP	320	82662	Orma_F	590
82411	Pound_T	175	82500	Xenia_AF PRO	737	82579	Rollip60_MP	320	82663	Orma_FJ	592
82412	Pound_T	175	82505	Xenia_AF PRO	738	82580	Rollip60_MP	320	82664	Orma_FJ	592
82413	Pound_T	175	82506	Xenia_AF PRO	738	82581	Rollip60_MP	320	82665	Orma_FO	596
82414	Pound_T	175	82507	Xenia_AF PRO	738	82582	Rollip60_MP	320	82666	Orma_FO	596
82415	Pound_T	175	82508	Xenia_AF PRO	738	82584	Rollip60_MP	320	82667	Orma_FL	594
82416	Pound_T	175	82509	Shaker	801	82585	Rollip60_MP	320	82668	Orma_FL	594
82417	Pound_T	175	82510	Shaker	801	82586	Rollip60_MP	320	82669	Orma_F	591
82422	Pound Focus	176	82511	Shaker	801	82587	Rollip60_MP	320	82670	Orma_F	591
82423	Pound Focus	176	82512	Quara_R	536	82588	Rollip60_PC	323	82671	Orma_F	591
82438	Pound Focus	176	82513	Quara_Q	538	82589	Rollip60_PC	323	82672	Orma_F	591
82439	Pound Focus	176	82514	Quara_QI	538	82590	Rollip60_PC	323	82673	Orma_F	591
82440	Pound Focus	176	82515	Vedette_Q	492	82591	Rollip60_PC	323	82674	Orma_F	591
82441	Pound Focus	176	82516	Vedette_Q	492	82592	Rollip60_MP	320	82675	Orma_FJ	592
82444	Pound Focus	178	82517	Vedette_Q	492	82593	Rollip60_MP	320	82676	Orma_FJ	592
82445	Pound Focus	178	82518	Vedette_Q	492	82594	Rollip60_MP	320	82677	Orma_FJ	592
82446	Pound Focus	178	82519	Vedette_Q	493	82595	Rollip60_MP	320	82678	Orma_FJ	592
82447	Pound Focus	178	82520	Vedette_Q	493	82596	Xenia_Pixel	847	82679	Orma_FO	596
82448	Pound Focus	178	82521	Orma_IJ	606	82597	Xenia_Pixel	847	82680	Orma_FO	596
82449	Pound Focus	178	82522	Orma_IJ	606	82598	Rollip60_MS	315	82681	Orma_FL	595
82452	Orma_CJ	473	82523	Orma_IJ	606	82599	Rollip60_MS	315	82682	Orma_FL	595
82453	Orma_CJ	473	82524	Orma_IJ	606	82600	Cell_Ww	136	82683	Orma_F	591
82454	Orma_CJ	474	82525	Orma_IJ	607	82601	Cell_Ww	136	82684	Orma_F	591
82455	Orma_CJ	474	82526	Orma_IJ	607	82602	Cell_Ww	136	82685	Orma_F	591
82456	Orma_IJ	606	82527	Suelo_R Pro	562	82603	Cell_SWw	277	82686	Orma_F	591
82457	Orma_IJ	606	82528	Suelo_R Pro	562	82604	Cell_SWw	277	82687	Orma_F	591

codes index

CODE	Product	Page	CODE	Product	Page	CODE	Product	Page	CODE	Product	Page
82688	Orma_F	591	82753	Tour_Track	246	82818	Vedette_R	489	82899	Optus_T	191
82689	Orma_FJ	593	82754	Tour_Track	246	82819	Vedette_R	489	82900	Optus_T	191
82690	Orma_FJ	593	82755	Tour_Track	246	82820	Vedette_R	489	82901	Navata_Optus	210
82691	Orma_FJ	593	82756	Tour_Track	246	82821	Vedette_R	489	82902	Navata_Optus	210
82692	Orma_FJ	593	82757	Tour_Projectors	246	82822	Vedette_R	489	82903	Navata_Optus	210
82693	Orma_FO	596	82758	Tour_Projectors	246	82823	Mini Albatros_M	334	82904	Navata_Optus	210
82694	Orma_FO	596	82759	Tour_Projectors	246	82824	Mini Albatros_M	334	82905	Navata_Optus	210
82695	Orma_FL	595	82760	Tour_Projectors	246	82825	Mini Albatros_M	335	82906	Navata_Optus	210
82696	Orma_FL	595	82761	Xenia_Blade_A	837	82826	Mini Albatros_M	335	82907	Navata_Optus	210
82697	Orma_F	590	82762	Xenia_Blade_AL	837	82827	Mini Albatros_M	334	82908	Navata_Optus	210
82698	Orma_F	590	82763	Vedette_Q	490	82828	Mini Albatros_M	334	82909	Navata_Optus	210
82699	Orma_FL	594	82764	Vedette_Q	490	82829	Mini Albatros_M	335	82910	Navata Pound Sha.D.	211
82700	Orma_FL	594	82765	Vedette_Q	490	82830	Accessories	335	82911	Navata Pound Sha.	211
82701	Clip_Hm	543	82766	Vedette_Q	490	82831	Emy	266	82912	Navata Pound Sha.D.	211
82702	Clip_Hm	543	82767	Vedette_Q	490	82832	Emy	266	82913	Navata Pound Sha.	211
82703	Clip_Hm	543	82768	Vedette_Q	491	82833	Emy	266	82914	Ink system_LP	347
82704	Clip	543	82769	Vedette_Q	491	82834	Mini Albatros	334	82916	Ink system_LP	347
82705	Clip	543	82770	Vedette_Q	491	82835	Mini Albatros	334	82918	Ink system_LP UGR	347
82706	Clip	543	82771	Vedette_Q	491	82836	Mini Albatros	334	82920	Ink system_LP UGR	347
82707	Clip	543	82772	Vedette_Q	491	82837	Mini Albatros	334	82922	Ink system_SP	349
82708	Clip	543	82773	Vedette_R	488	82838	Mini Albatros_M	334	82926	Ink system_LP	348
82709	Clip	543	82774	Vedette_R	488	82839	Mini Albatros_M	334	82928	Ink system_LP	348
82710	Clip_Hm	543	82775	Vedette_R	488	82840	Mini Albatros_M	335	82930	Ink system_LP	348
82711	Xenia_A PRO	733	82776	Vedette_R	488	82841	Mini Albatros_M	335	82932	Ink system_LP UGR	348
82712	Xenia_AF PRO	737	82777	Vedette_R	488	82842	Mini Albatros_M	334	82934	Orma_IJ	606
82713	Suelo_RXJ	578	82778	Vedette_R	489	82843	Mini Albatros_M	334	82935	Orma_IJ	606
82714	Suelo_RXJ	578	82779	Vedette_R	489	82844	Mini Albatros_M	335	82940	Cell_Ww	136
82715	Suelo_RXJ	578	82780	Vedette_R	489	82845	Mini Albatros_M	335	82941	Cell_Ww	136
82716	Suelo_RXJ	578	82781	Vedette_R	489	82846	Accessories	894	82942	Cell_Ww	136
82717	Suelo_RXJ	578	82782	Vedette_R	489	82847	Accessories	894	82944	Ink system_LP UGR	348
82718	Suelo_RXJ	578	82783	Vedette_Q	490	82853	Rollip60_MP	320	82946	Ink system_LP	346
82719	Suelo_RXJ	578	82784	Vedette_Q	490	82865	Quantum_R	34	82947	Ink system_LP	346
82720	Suelo_RXJ	578	82785	Vedette_Q	490	82866	Quantum_R	34	82948	Ink system_LP	346
82721	Suelo_RFJ	579	82786	Vedette_Q	490	82867	Quantum_R	34	82949	Ink system_LP	346
82722	Suelo_RFJ	579	82787	Vedette_Q	490	82868	Quantum_R	34	82950	Ink system_LP	346
82723	Suelo_RXJ	578	82788	Vedette_Q	491	82869	Quantum_R	34	82951	Ink system_LP	346
82724	Suelo_RFJ	579	82789	Vedette_Q	491	82870	Quantum_R	34	83002	Accessories	915
82725	Tour_Cell_P	242	82790	Vedette_Q	491	82871	Quantum_R	34	83003	Accessories	915
82726	Tour_Cell_P	242	82791	Vedette_Q	491	82872	Quantum_R	34	83004	Accessories	915
82727	Tour_Cell_C	233	82792	Vedette_Q	491	82873	Quantum_R	34	83006	Accessories	915
82728	Creek Accessories	218	82793	Vedette_R	488	82874	Quantum_R	34	83007	Electronics	924
82729	Creek Accessories	218	82794	Vedette_R	488	82875	Quantum_R	34	83008	Electronics	929
82730	Creek Accessories	218	82795	Vedette_R	488	82876	Quantum_R	34	83009	Electronics	940
82731	Creek Optus	219	82796	Vedette_R	488	82877	Quantum_R	35	83010	Electronics	942
82732	Creek Optus	219	82797	Vedette_R	488	82878	Quantum_R	35	83012	Electronics	942
82733	Creek Optus	219	82798	Vedette_R	489	82879	Quantum_R	35	83013	Electronics	942
82734	Creek Optus	219	82799	Vedette_R	489	82880	Quantum_R	35	83015	Electronics	942
82735	Creek Optus	219	82800	Vedette_R	489	82881	Quantum_R	35	83016	Electronics	922
82736	Creek Optus	219	82801	Vedette_R	489	82882	Quantum_R	35	83017	Electronics	922
82737	Optus_EX	146	82802	Vedette_R	489	82883	Quantum_R	35	83018	Electronics	934
82738	Optus_EX	146	82803	Vedette_Q	490	82884	Quantum_R	35	83019	Electronics	934
82739	Optus_EX	146	82804	Vedette_Q	490	82885	Quantum_R	35	83020	Accessories	873
82740	Optus_EX	146	82805	Vedette_Q	490	82886	Quantum_R	35	83034	Accessories	894
82741	Step66	531	82806	Vedette_Q	490	82887	Quantum_R	35	83036	Accessories	611
82742	Step66	531	82807	Vedette_Q	490	82888	Quantum_R	35	83037	Accessories	611
82743	Step66	531	82808	Vedette_Q	491	82889	Optus_T	191	83038	Accessories	611
82744	Step66	531	82809	Vedette_Q	491	82890	Optus_T	191	83039	Accessories	611
82745	Step66	531	82810	Vedette_Q	491	82891	Optus_T	191	83040	Accessories	611
82746	Step66	531	82811	Vedette_Q	491	82892	Optus_T	191			356
82747	Step66	531	82812	Vedette_Q	491	82893	Optus_T	191			935
82748	Step66	531	82813	Vedette_R	488	82894	Optus_T	191			356
82749	Mini Albatros	334	82814	Vedette_R	488	82895	Optus_T	191			935
82750	Mini Albatros	334	82815	Vedette_R	488	82896	Optus_T	191	83048	Accessories	467
82751	Mini Albatros	334	82816	Vedette_R	488	82897	Optus_T	191	83049	Accessories	715
82752	Mini Albatros	334	82817	Vedette_R	488	82898	Optus_T	191	83053	Navata Base	212

CODE	Product	Page	CODE	Product	Page	CODE	Product	Page	CODE	Product	Page
83054	Navata Base	212	83145	Electronics	952	83606	Alcor_R	627	83688	Portik_R	478
83055	Navata Base	212	83146	Electronics	948	83607	Alcor_R	627	83689	Portik_Q	479
83058	Electronics	929	83147	Electronics	948	83608	Alcor_R	627	83690	Portik_Q	479
83059	Electronics	929	83148	Electronics	956	83609	Alcor_R	627	83691	Portik_Q	479
83060	Electronics	929	83149	Electronics	957	83610	Alcor_Q	628	83692	Portik_Q	479
83061	Electronics	929	83150	Electronics	957	83611	Alcor_Q	628	83693	Portik_R	478
83062	Electronics	934	83151	Electronics	957	83612	Alcor_Q	628	83694	Portik_R	478
83063	Accessories	22	83152	Electronics	957	83613	Envelope_1	520	83695	Portik_R	478
83064	Accessories	22	83153	Accessories	350	83614	Cicada	497	83696	Portik_R	478
83065	Accessories	22	83154	Electronics	938	83615	Cicada	497	83697	Portik_Q	479
83066	Electronics	929	83159	Electronics	928	83616	Cicada	497	83698	Portik_Q	479
83067	Trunking system	339	83160	Accessories	877	83617	Cicada	497	83699	Portik_Q	479
83068	Accessories	340	83161	Accessories	877	83618	Cicada	497	83700	Portik_Q	479
83069	Accessories	340	83162	Accessories	757	83619	Cicada	497	83711	Shaker	801
83096	Accessories	583	83168	Navata Base	212	83620	Cicada	497	83712	Modus_M Master	294
83097	Accessories	583	83169	Navata Base	212	83621	Cicada	497	83713	Modus_M Master	294
83098	Accessories	583	83170	Navata Base	212	83622	Cicada	497	83714	Modus_M Master	294
83100	Electronics	938	83171	Navata Base	212	83623	Cicada	497	83715	Modus_M Master	294
83101	Electronics	938	83172	Navata Base	212	83624	Cicada	497	83716	Modus_M Slave	294
83102	Electronics	938	83173	Navata Base	212	83625	Cicada	497	83717	Modus_M Slave	294
83103	Electronics	938	83174	Navata Base	212	83626	Cicada	497	83718	Modus_M Slave	294
83104	Electronics	922	83175	Navata Base	212	83627	Cicada	497	83719	Modus_M Slave	294
83105	Electronics	922	83176	Navata Base	212	83628	Cicada	497	83720	Modus_M Cell	297
83106	Electronics	922	83177	Electronics	951	83629	Cicada	497	83721	Modus_M Cell_Ww	297
83107	Electronics	922	83178	Electronics	951	83630	Orma_IM	528	83722	Modus_M Micropris.	296
83108	Modus_M Caps	294	83179	Electronics	943	83631	Orma_AM	527	83723	Modus_M Micropris.	296
		295	83181	Accessories	531	83632	Orma_IM	528	83724	Modus_M Micropris.	296
		294	83183	Accessories	912	83633	Orma_AM	527	83725	Modus_M Acc.	297
83109	Modus_M Caps	295	83184	Accessories	912	83634	Orma_IM	528	83726	Modus_M Acc.	297
		294	83186	Accessories	359	83635	Orma_AM	527	83727	Modus_M Acc.	297
83110	Modus_M Caps	295	83187	Electronics	950	83636	Orma_IM	528	83728	Modus_M Acc.	297
		295			741	83637	Orma_AM	527	83729	Modus_M Acc.	297
83111	Electronics	925	83188	Accessories	837	83638	Orma_IM	528	83730	Modus_M Projectors	296
83112	Electronics	925			922	83639	Orma_AM	527	83731	Modus_M Projectors	296
83113	Electronics	925	83189	Electronics	922	83640	Orma_IM	528	83732	Modus_M Optus_EX	296
83114	Electronics	925	83192	Electronics	955	83641	Orma_AM	527			294
83115	Electronics	949	83193	Electronics	954	83642	Orma_IB	839	83733	Modus_M Corner	295
83116	Electronics	949	83194	Electronics	939	83643	Orma_IB	839			298
83118	Electronics	949	83195	Electronics	939	83644	Orma_AB	839	83734	Modus_M Complete	298
83119	Electronics	949	83196	Electronics	939	83645	Orma_AB	839	83735	Modus_M Complete	298
83120	Electronics	930			865	83646	Rollip60_MP	320	83736	Modus_M Master	294
83121	Electronics	930	83197	Accessories	867	83647	Rollip60_MP	320	83737	Modus_M Master	294
83122	Electronics	926			865	83648	Rollip60_MP	320	83738	Modus_M Master	294
83123	Accessories	769	83198	Accessories	867	83649	Rollip60_MP	320	83739	Modus_M Master	294
83124	Accessories	769			849	83651	Trunking system	338	83740	Modus_M Slave	294
83125	Accessories	769	83199	Accessories	849	83652	Trunking system	338	83741	Modus_M Slave	294
83126	Accessories	769	83200	Accessories	849	83653	Trunking system	338	83742	Modus_M Slave	294
83129	Accessories	912	83201	Accessories	849	83654	Trunking system	338	83743	Modus_M Slave	294
83130	Accessories	913	83202	Accessories	849	83655	Trunking system	338	83744	Modus_M Cell	297
83131	Accessories	916	83521	Alcor_R Blade	629	83656	Trunking system	339	83745	Modus_M Cell_Ww	297
		912	83522	Astropek_Blade	637	83657	Ribbon	906	83746	Modus_M Micropris.	296
83132	Accessories	913	83523	Alcor_R Blade	629	83658	Ribbon	906	83747	Modus_M Micropris.	296
		916	83524	Astropek_Blade	637	83659	Ribbon	906	83748	Modus_M Micropris.	296
83133	Accessories	912	83579	Quara_R	536	83675	Beriel	429	83749	Modus_M Acc.	297
83135	Accessories	913	83580	Quara_R	536	83676	Beriel	429	83750	Modus_M Acc.	297
83136	Accessories	916	83581	Quara_R	536	83677	Beriel	429	83751	Modus_M Acc.	297
83137	Accessories	912	83582	Quara_R	395	83678	Beriel	428	83752	Modus_M Acc.	297
83138	Accessories	912	83583	Quara_Q	538	83679	Beriel	428	83753	Modus_M Acc.	297
83139	Accessories	912	83584	Quara_Q	538	83680	Beriel	428	83754	Modus_M Projectors	296
83140	Accessories	865	83585	Quara_Q	538	83681	Beriel	427	83755	Modus_M Projectors	296
		865	83586	Quara_Q	395	83682	Beriel	427	83756	Modus_M Optus_EX	296
83141	Accessories	867	83589	Xenia_AF RGBW	737	83683	Beriel	427			294
		865	83590	Xenia_AF RGBW	737	83685	Portik_R	478	83757	Modus_M Corner	295
83142	Accessories	867	83601	Envelope_R	520	83686	Portik_R	478			298
83143	Electronics	926	83602	Envelope_R	520	83687	Portik_R	478	83758	Modus_M Complete	298
83144	Electronics	952	83603	Envelope_R	520				83759	Modus_M Complete	298
			83604	Envelope_R	520				83760	Modus_M Micropris.	296

codes index

CODE	Product	Page	CODE	Product	Page	CODE	Product	Page	CODE	Product	Page
83761	Modus_M Micropris.	296	83825	Pound_T	174	83892	Thin66	760	83958	Ink system_SP F.	355
83762	Modus_M Micropris.	296	83826	Pound_T	174	83893	Cell_Ww_Track	199	83959	Ink system_SP	355
83763	Lino	691	83827	Pound Focus	177	83894	Cell_Ww_Track	199	83960	Ink system_P	354
83764	Warp_R PRO	47	83828	Pound Focus	177	83895	Pound Shaper Dist.	180	83961	Ink system_LP	354
83765	Warp_R PRO	47	83829	Pound Focus	177	83896	Pound Shaper Dist.	180	83962	Ink system_LP	354
83766	Warp_R PRO	47	83830	Pound Focus	177	83897	Pound Shaper	180	83963	Ink system_LP UGR	354
83767	Warp_R PRO	47	83831	Pound Focus	177	83898	Pound Shaper	180	83964	Ink system_LP UGR	354
83768	Warp_R PRO	47	83832	Pound Focus	177	83899	Pound Shaper Dist.	180	83965	Ink system_LP	354
83769	Warp_R PRO	47	83833	Pound Focus	177	83900	Pound Shaper Dist.	180	83966	Ink system_LP	354
83770	Warp_R PRO	47	83834	Pound Focus	177	83901	Pound Shaper	180	83968	Ink system_L	347
83771	Warp_R PRO	47	83835	Pound Focus	177	83902	Pound Shaper	180	83969	Ink system_L	347
83772	Warp_R PRO	47	83836	Pound Focus	177	83903	Optus_T	192	83970	Ink system_L UGR	347
83773	Warp_R PRO	47	83837	Modus_M Complete	298	83904	Optus_T	192	83971	Ink system_L UGR	347
83774	Warp_R PRO	47	83838	Modus_M Complete	298	83905	Optus_T	192	83972	Ink system_L	347
83775	Warp_R PRO	47	83839	Pound Focus	177	83906	Optus_T	192	83973	Ink system_L	347
83776	Suelo_RFJ	579	83840	Pound Focus	177	83907	Optus_T	192	83974	Ink system_L	347
83777	Suelo_RFJ	579	83842	Modus_M MasterDW	295	83908	Optus_T	192	83975	Ink system_SP	349
83778	Suelo_RFJ	579	83843	Modus_M MasterDW	295	83909	Optus_T	192	83976	Ink system_SP	349
83779	Suelo_RFJ	579	83844	Modus_M MasterDW	295	83910	Optus_T	192	83977	Ink system_SP F.	349
83780	Suelo_RFJ	579	83845	Modus_M MasterDW	295	83911	Optus_T	192	83978	Ink system_SP	349
83781	Suelo_RFJ	579	83846	Modus_M Slave DW	295	83912	Optus_T	192	83979	Ink system_P	348
83782	Modus_M Master	294	83847	Modus_M Slave DW	295	83913	Optus_T	192	83980	Ink system_LP	348
83783	Modus_M Master	294	83848	Modus_M Slave DW	295	83914	Optus_T	192	83981	Ink system_LP	348
83784	Modus_M Master	294	83849	Modus_M Slave DW	295	83915	Optus_T	192	83982	Ink system_LP UGR	348
83785	Modus_M Master	294	83851	Prolamp	820	83916	Optus_T	192	83983	Ink system_LP UGR	348
83786	Modus_M Slave	294	83852	Prolamp	820	83917	Optus_T	192	83987	Ink system_L	346
83787	Modus_M Slave	294	83853	Prolamp	820	83918	Optus_T	192	83988	Ink system_L	346
83788	Modus_M Slave	294	83854	Prolamp	820	83919	Optus_T	192	83989	Ink system_L	346
83789	Modus_M Slave	294	83855	Prolamp	820	83920	Optus_T	192	83990	Ink system_L	346
83790	Modus_M Corner	294	83856	Prolamp	820	83921	Optus_Ww	194	83991	Ink system_L	346
83791	Modus_M MasterDW	295	83857	Prolamp	820	83922	Optus_Ww	194	83992	Ink system_L	346
83792	Modus_M MasterDW	295	83858	Prolamp	820	83923	Optus_Ww	194	83993	Ink system_L	352
83793	Modus_M MasterDW	295	83859	Skin_F	769	83924	Optus_Ww	194	83994	Ink system_L	352
83794	Modus_M MasterDW	295	83860	Skin_F	769	83925	Suelo_RX	578	83995	Ink system_L UGR	352
83795	Modus_M Slave DW	295	83861	Skin_S	769	83926	Suelo_RX	578	83996	Ink system_L UGR	352
83796	Modus_M Slave DW	295	83862	Skin_F	769	83927	Suelo_RX	578	83997	Ink system_SP	355
83797	Modus_M Slave DW	295	83863	Skin_F	769	83928	Suelo_RX	578	83998	Ink system_SP	355
83798	Modus_M Slave DW	295	83864	Skin_S	769	83929	Suelo_RX	578	83999	Ink system_SP F.	355
83799	Pound_T	174	83865	Skin_FL	769	83930	Suelo_RX	578	84000	Ink system_SP	355
83800	Pound_T	174	83866	Skin_F	768	83931	Suelo_RF	579	84001	Ink system_P	354
83801	Pound_T	174	83867	Skin_F	768	83932	Suelo_RF	579	84002	Ink system_LP	354
83802	Pound_T	174	83868	Skin_S	768	83933	Suelo_RF	579	84003	Ink system_LP	354
83803	Pound_T	174	83869	Skin_F	768	83934	Suelo_RF	579	84004	Ink system_LP UGR	354
83804	Pound_T	174	83870	Skin_F	768	83935	Suelo_RF	579	84005	Ink system_LP UGR	354
83805	Pound_T	174	83871	Skin_S	768	83936	Suelo_RF	579	84010	Accessories	358
83806	Pound_T	174	83872	Skin_FL	768	83937	Suelo_RX	578	84011	Accessories	358
83807	Pound_T	174	83873	Skin_Y	768	83938	Suelo_RX	578	84012	Accessories	350
83808	Pound_T	174	83874	Intake_PRO	525	83939	Suelo_RF	579	84013	Accessories	350
83809	Pound_T	174	83875	Blum	684	83940	Suelo_RF	579	84014	Accessories	350
83810	Pound_T	174	83876	Blum	684	83941	Suelo_RX	578	84015	Accessories	350
83811	Pound_T	174	83877	Blum Flower	685	83942	Suelo_RF	579	84016	Ink system Cables	346
83812	Pound_T	174	83878	Blum Flower	685	83943	Ink system_L	347	84017	Accessories	358
83813	Modus_M Complete	298	83879	Blum	684	83944	Ink system_L	347	84018	Accessories	356
83814	Modus_M Complete	298	83880	Blum	684	83945	Ink system_L	347	84023	Woofers_R	449
83815	Modus_M MasterDW	295	83881	Blum Flower	685	83946	Ink system_SP	349	84024	Woofers_RX	449
83816	Modus_M MasterDW	295	83882	Blum Flower	685	83947	Ink system_SP F.	349	84025	Nautilus_RP	868
83817	Modus_M MasterDW	295	83883	Accessories	685	83948	Ink system_SP	349	84026	Nautilus_RP	868
83818	Modus_M MasterDW	295	83884	Accessories	685	83949	Ink system_LP	348	84027	Nautilus_RP	869
83819	Modus_M Slave DW	295	83885	Thin66	760	83950	Ink system_LP	348	84028	Nautilus_RP	869
83820	Modus_M Slave DW	295	83886	Thin66	760	83952	Ink system_L	352	84029	Nautilus_RP	869
83821	Modus_M Slave DW	295	83887	Thin66	760	83953	Ink system_L	352	84030	Nautilus_RP	869
83822	Modus_M Slave DW	295	83888	Thin66	760	83954	Ink system_L UGR	352	84031	Nautilus_RF	864
83823	Pound_T	174	83889	Thin66	760	83955	Ink system_L UGR	352	84032	Nautilus_RF	864
83824	Pound_T	174	83890	Thin66	760	83956	Ink system_SP	355	84033	Nautilus_RF	864
			83891	Thin66	760	83957	Ink system_SP	355			

CODE	Product	Page	CODE	Product	Page	CODE	Product	Page	CODE	Product	Page
84034	Nautilus_RF	864	84102	Warp_Q	53	84167	Pound_T	172	84274	Skylum_Q	254
84035	Nautilus_RF	866	84103	Warp_Q	53	84168	Pound_T	172	84275	Skylum_Q	254
84036	Nautilus_RF	866	84104	Warp_Q	53	84169	Skylum_Q PRO	255	84276	Skylum_Q	254
84037	Nautilus_RF	865	84105	Warp_Q	53	84170	Skylum_Q PRO	255	84277	Skylum_Q	254
84038	Nautilus_RF	865	84106	Warp_Q	53	84171	Skylum_Q PRO	255	84278	Skylum_Q	254
84039	Nautilus_RF	865	84107	Warp_RJ	50	84172	Optus_W2	196	84283	Arcada Pro	833
84040	Nautilus_RF	865	84108	Warp_RJ	50	84173	Optus_W2	196	84284	Arcada Pro	833
84041	Nautilus_RF	866	84109	Warp_RJ	50	84174	Optus_W2	196	84285	Arcada Pro	833
84042	Nautilus_RF	867	84110	Warp_RJ	50	84175	Optus_W2	196	84286	Arcada Pro	833
84043	Nautilus_RF	866	84111	Loro_R	70	84176	Optus_W2	196	84287	Arcada Pro	833
84044	Nautilus_RF	867	84112	Loro_R	70	84177	Optus_W2	196	84288	Arcada Pro	833
84045	Xenia_AF PRO	738	84113	Loro_R	70	84178	Optus_W3	196			393
84046	Xenia_AF PRO	738	84114	Loro_R	70	84179	Optus_W3	196			414
84047	Xenia_W RGBW	727	84115	Loro_R	70	84180	Optus_W3	196	84335	Accessories	433
84048	Xenia_W RGBW	727	84116	Loro_R	70	84181	Optus_W3	196			433
84049	Xenia_W PRO	730	84117	Loro_R	70	84182	Optus_W3	196			389
84050	Xenia_W PRO	730	84118	Loro_R	70	84183	Optus_W3	196			393
84051	Xenia_A RGBW	733	84119	Loro_R	71	84184	Nail_W	495			419
84052	Xenia_A RGBW	733	84120	Loro_R	71	84185	Nail_W	495	84336	Accessories	421
84053	Xenia_A PRO RGBW	735	84121	Loro_R	71	84186	Nail_W	495			521
84054	Xenia_A PRO RGBW	735	84122	Loro_R	71	84187	Nail_W	495			545
84055	Paseo_L	750	84123	Loro_R	71	84188	Nail_W	495			547
84056	Paseo_L	750	84124	Loro_R	71	84189	Nail	677	84337	Accessories	401
84057	Paseo_L	750	84125	Loro_R	71	84190	Nail	677			395
84058	Paseo_X	753	84126	Loro_R	71	84191	Nail	677			539
84059	Paseo_X	753	84127	Loro_Q	74	84192	Nail	677	84338	Accessories	539
84060	Thin66 RGBW	760	84128	Loro_Q	74	84193	Nautilus_RP	868			541
84061	Thin66 RGBW	760	84129	Loro_Q	74	84194	Nautilus_RP	868	84341	Accessories	629
84062	Thin66 RGBW	760	84130	Loro_Q	74	84195	Ribbon	907			401
84063	Thin66 RGBW	760	84131	Loro_Q	74	84196	Ribbon	907	84349	Accessories	435
84064	Thin66 RGBW	760	84132	Loro_Q	74	84197	Ribbon RGBW	907	84626	Electronics	933
84065	Thin66 RGBW	760	84133	Loro_Q	74	84198	Ribbon RGBW	907			932
84066	Thin66 RGBW	760	84134	Loro_Q	74	84199	Giotto_R	82			944
84067	Thin66 RGBW	760	84135	Loro_Q	75	84200	Giotto_R	82	84700	Electronics	945
84071	Envelope_R	520	84136	Loro_Q	75	84201	Giotto_R	82			950
84072	Envelope_R	520	84137	Loro_Q	75	84202	Giotto_R	82	84701	Electronics	932
84073	Accessories	350	84138	Loro_Q	75	84203	Giotto_R	82	84787	Electronics	933
84074	Accessories	350	84139	Loro_Q	75	84204	Giotto_R	82	84829	Electronics	931
84075	Quara_R	536	84140	Loro_Q	75	84205	Giotto_R	82	84863	Accessories	960
84076	Quara_R	536	84141	Loro_Q	75	84206	Giotto_R	82	84864	Accessories	960
84077	Quara_R	536	84142	Loro_Q	75	84207	WoofeR_RX	111			950
84078	Quara_F	537	84143	Loro_RJ	73	84208	WoofeR_RX	111			951
84079	Rollip_PC	449	84144	Loro_RJ	73	84209	WoofeR_R	110			952
84080	Rollip_PC	449	84145	Loro_RJ	73	84210	WoofeR_R	110			953
84081	Rollip_PC	449	84146	Loro_RJ	73	84211	WoofeR_R	110	84865	Electronics	954
84082	Rollip_PC	449	84147	Loro_RJ	73	84212	Rodix	877			955
84083	Warp_R	43	84148	Loro_RJ	73	84213	Rodix	877			956
84084	Warp_R	43	84149	Loro_RJ	73	84214	Paseo Dark	750			962
84085	Warp_R	43	84150	Loro_RJ	73	84215	Paseo Dark	750	84866	Accessories	960
84086	Warp_R	43	84151	Loro_QJ	76	84216	Paseo Dark	750	84867	Accessories	960
84087	Warp_R	43	84152	Loro_QJ	76	84217	Paseo_PIXEL	851			952
84088	Warp_R	43	84153	Loro_QJ	76	84218	Paseo_PIXEL	851	84869	Electronics	961
84089	Warp_R	43	84154	Loro_QJ	76	84228	WoofeR_RX	111			961
84090	Warp_R	43	84155	Loro_QJ	77	84229	WoofeR_RX	111	84870	Accessories	961
84091	Warp_R	46	84156	Loro_QJ	77	84230	WoofeR_R	110	84871	Accessories	961
84092	Warp_R	46	84157	Loro_QJ	77	84231	WoofeR_R	110	84872	Accessories	960
84093	Warp_R	46	84158	Loro_QJ	77	84232	WoofeR_R	110	84873	Accessories	960
84094	Warp_R	46	84159	Optus_EX	147	84255	Modus_M Complete	298	84874	Accessories	960
84095	Warp_Q	52	84160	Optus_EX	147	84256	Modus_M Complete	298	84875	Accessories	960
84096	Warp_Q	52	84161	Optus_EX	148	84257	Modus_M Complete	298	84876	Accessories	960
84097	Warp_Q	52	84162	Optus_EX	148	84258	Modus_M Complete	298	84885	Accessories	961
84098	Warp_Q	52	84163	Optus_EX	148	84270	Skylum_Q PRO	255	84887	Accessories	960
84099	Warp_Q	53	84164	Optus_EX	148	84271	Skylum_Q PRO	255	84888	Accessories	960
84100	Warp_Q	53	84165	Pound_T	172	84272	Skylum_Q PRO	255			
84101	Warp_Q	53	84166	Pound_T	172	84273	Skylum_Q	254			

codes index

CODE	Product	Page	CODE	Product	Page	CODE	Product	Page	CODE	Product	Page
		583	85542	Quara_R	536	87602	Alcor_R	626	89362	Accessories	761
		629	85543	Quara_R	536	87603	Alcor_R	626	89365	Accessories	954
84890	Accessories	815	85575	Bibok	409	87604	Alcor_R	626			962
		811	85947	Aspho_R	412	87605	Alcor_R	626			801
		815	85948	Aspho_R	412	87988	Quara_R	536	89371	Accessories	805
84892	Accessories	960	85950	Aspho_Q	414	87989	Quara_Q	538			811
84893	Accessories	961	85951	Aspho_Q	414	88417	Aspho_R	412			21
84894	Accessories	961	85959	Aspho_R	412	88418	Aspho_R	412			22
84895	Accessories	961	85960	Aspho_R	412	88421	Nitum_R	417			27
		583	85962	Aspho_Q	414	88422	Nitum_Q	418			28
84900	Accessories	629	85963	Aspho_Q	414	88423	Nitum_R	417			86
		393	85976	Bibok	409	88424	Nitum_Q	418	89373	Accessories	87
		419	85979	Bibok	409	88568	Nitum_R	417			104
84901	Accessories	421	86096	Alcor_AI	630	88569	Nitum_Q	418			105
		433	86097	Alcor_AI	631	89045	Accessories	741			106
84902	Accessories	423	86100	Alcor_AI	630	89046	Accessories	741			107
84906	Accessories	621	86101	Alcor_AI	631	89047	Accessories	741			455
		393	86104	Alcor_AI	630	89119	Accessories	910			21
		419	86105	Alcor_AI	631	89120	Accessories	911			22
84915	Accessories	521	86402	Quara_R	395	89121	Accessories	910			27
		545	86407	Picrol	421	89122	Accessories	911			28
		547	86408	Picrol	421	89123	Accessories	910			86
		409	86460	Quara_F	537	89124	Accessories	911	89374	Accessories	87
84916	Accessories	414	86562	Quara_Q	538	89125	Accessories	910			104
		433	86563	Quara_Q	538	89126	Accessories	911			105
		393	86564	Quara_Q	395	89144	Electronics	924			106
		409	86612	Nitum_R	417	89145	Electronics	924			107
84917	Accessories	414	86613	Nitum_R	417	89146	Electronics	924	89408	Electronics	931
		433	86614	Nitum_Q	418	89147	Electronics	924	89419	Electronics	936
		583	86615	Nitum_Q	418			445	89420	Electronics	936
84918	Accessories	629	86674	Nitum_R	417	89148	Accessories	936	89421	Electronics	936
84928	Accessories	621	86675	Nitum_Q	418	89149	Electronics	936	89422	Electronics	936
84932	Accessories	583	86679	Ilamt	401	89150	Electronics	936	89423	Electronics	936
84933	Accessories	583	86707	Aspho_R	413			445	89488	Electronics	940
		583	86708	Aspho_R	413	89151	Electronics	936	89548	Accessories	881
84935	Accessories	633	86717	Vissa_R	399	89175	Electronics	944			895
		583	86718	Vissa_R	399	89176	Electronics	944	89629	Accessories	911
84936	Accessories	633	86719	Vissa_Q	399	89177	Electronics	944	89630	Accessories	911
		399	86720	Vissa_Q	399	89179	Electronics	940	90400	Clivo_SL	811
84952	Accessories	399	86730	Aspho_R	413			742	90401	Clivo_SL	811
84954	Accessories	433	86731	Aspho_R	413			754	90402	Clivo_SL	811
84955	Accessories	421	86737	Astropek	636	89186	Accessories	952	90403	Clivo_SL	811
84956	Accessories	421	86787	Astropek	636			956	90404	Clivo_SL	811
84992	Accessories	789	86788	Astropek	636			742	90406	Vos_Q	26
84994	Accessories	961	86789	Astropek	636	89187	Accessories	754	90407	Vos_Q	26
85001	Aspho_R	412	86881	Nitum_R	417			954	90408	Vos_R	20
85002	Aspho_R	412	86882	Nitum_Q	418			742	90409	Vos_R	20
85004	Aspho_Q	414	86883	Nitum_R	417	89188	Accessories	754	90410	Vos_Q	26
85005	Aspho_Q	414	86884	Nitum_Q	418			761	90411	Vos_Q	26
85013	Aspho_R	412	87067	Calypto	435			763	90412	Vos_R	20
85014	Aspho_R	412	87068	Calypto	435			742	90413	Vos_R	20
85016	Aspho_Q	414	87214	Aspho_R	413	89189	Accessories	754	90414	Vos_Q	26
85017	Aspho_Q	414	87215	Aspho_R	413			954	90415	Vos_Q	26
85025	Aspho_R	412	87323	Elin	430			742	90416	Vos_R	20
85026	Aspho_R	412	87324	Beriel	426	89190	Accessories	761	90417	Vos_R	20
85028	Aspho_Q	414	87325	Beriel	426			754	90418	Vos_Q	26
85029	Aspho_Q	414	87330	Gude	432			742	90419	Vos_Q	26
85043	Nitum_R	417	87332	Gude	432	89190	Accessories	763	90420	Vos_R	20
85044	Nitum_R	417	87335	Gude	432			837	90421	Vos_R	20
85045	Nitum_Q	418	87337	Elin	430			903	90428	Vos_Q	27
85046	Nitum_Q	418	87340	Elin	430	89223	Accessories	909	90429	Vos_Q	27
85059	Nitum_R	417	87350	Ture	431	89359	Electronics	940	90430	Vos_R	21
85060	Nitum_R	417	87353	Ture	431			742	90431	Vos_R	21
85061	Nitum_Q	418	87356	Ture	431	89361	Accessories	754	90438	Vos_Q	27
85062	Nitum_Q	418	87600	Alcor_R	626			761	90439	Vos_Q	27
85335	Bibok	409	87601	Alcor_R	626						

CODE	Product	Page	CODE	Product	Page	CODE	Product	Page	CODE	Product	Page
90440	Vos_R	21	90571	Quantum_RJ	36	90676	Vos_Q	27	90769	Warp_Q	52
90441	Vos_R	21	90572	Quantum_RJ	36	90677	Vos_Q	27	90770	Warp_Q	52
90458	Archiline PRO_W	720	90573	Quantum_RJ	36	90678	Vos_Q	27	90771	Warp_Q	52
90459	Archiline PRO_W	720	90574	Quantum_RJ	37	90679	Vos_Q	27	90772	Warp_Q	52
90460	Archiline PRO_W	720	90575	Quantum_RJ	37	90680	Vos_R	21	90773	Warp_Q	52
90461	Archiline PRO_W	720	90609	Quantum_R	35	90681	Vos_R	21	90774	Warp_Q	52
90462	Archiline PRO_W	720	90610	Quantum_R	35	90682	Vos_R	21	90775	Warp_Q	52
90463	Archiline PRO_W	720	90612	Warp_R	46	90683	Vos_R	21	90776	Warp_R	43
90495	Tee_1	444	90613	Warp_R	46	90684	Vos_Q	27	90777	Warp_R	43
90496	Tee_1	444	90620	Vos_Q	26	90685	Vos_Q	27	90778	Warp_R	43
90497	Tee_1	444	90621	Vos_Q	26	90686	Vos_Q	27	90779	Warp_R	43
90498	Tee_1	444	90622	Vos_R	20	90687	Vos_Q	27	90780	Warp_R	43
90499	Tee_1	444	90623	Vos_R	20	90688	Vos_R	21	90781	Warp_R	43
90500	Tee_1	444	90624	Vos_Q	26	90689	Vos_R	21	90782	Warp_Q	53
90501	Tee_1	444	90625	Vos_Q	26	90690	Vos_R	21	90783	Warp_Q	53
90502	Tee_1	444	90626	Vos_R	20	90691	Vos_R	21	90784	Warp_Q	53
90503	Tee_1	444	90627	Vos_R	20	90720	Warp_R	42	90785	Warp_Q	53
90504	Tee_1	444	90628	Vos_Q	26	90721	Warp_R	42	90786	Warp_Q	53
90505	Tee_1	444	90629	Vos_Q	26	90722	Warp_R	42	90787	Warp_Q	53
90506	Tee_1	444	90630	Vos_Q	26	90723	Warp_R	42	90788	Warp_Q	53
90507	Tee_2	444	90631	Vos_Q	26	90724	Warp_Q	52	90789	Warp_Q	53
90508	Tee_2	444	90632	Vos_R	20	90725	Warp_Q	52	90790	Warp_R	46
90509	Tee_2	444	90633	Vos_R	20	90726	Warp_Q	52	90791	Warp_R	46
90510	Tee_2	444	90634	Vos_R	20	90727	Warp_Q	52	90792	Warp_R	46
90511	Tee_2	444	90635	Vos_R	20	90728	Warp_Q	52	90793	Warp_R	46
90512	Tee_2	444	90636	Vos_Q	26	90729	Warp_Q	52	90794	Warp_R	46
90513	Tee_2	444	90637	Vos_Q	26	90730	Warp_Q	52	90795	Warp_R	46
90514	Tee_2	444	90638	Vos_R	20	90731	Warp_Q	52	90796	Warp_Q	53
90515	Tee_2	444	90639	Vos_R	20	90732	Warp_Q	52	90797	Warp_Q	53
90516	Tee_2	444	90640	Vos_Q	26	90733	Warp_Q	52	90798	Warp_Q	53
90517	Tee_2	444	90641	Vos_Q	26	90734	Warp_Q	52	90799	Warp_Q	53
90518	Tee_2	444	90642	Vos_Q	26	90735	Warp_Q	52	90800	Warp_Q	53
90519	Periskop	794	90643	Vos_Q	26	90736	Warp_Q	52	90801	Warp_Q	53
90520	Periskop	794	90644	Vos_R	20	90737	Warp_Q	52	90802	Warp_Q	53
90521	Periskop	794	90645	Vos_R	20	90738	Warp_Q	52	90803	Warp_Q	53
90522	Periskop	794	90646	Vos_R	20	90739	Warp_Q	52	90812	Warp_RY	48
90542	Warp_R	42	90647	Vos_R	20	90740	Warp_R	42	90813	Warp_RY	48
90543	Warp_R	42	90648	Vos_Q	26	90741	Warp_R	42	90814	Warp_RY	48
90544	Warp_R	42	90649	Vos_Q	26	90742	Warp_R	42	90815	Warp_RY	48
90545	Warp_R	42	90650	Vos_R	20	90743	Warp_R	42	90816	Warp_RY	48
90546	Warp_R	42	90651	Vos_R	20	90744	Warp_R	42	90817	Warp_RY	48
90547	Warp_R	42	90652	Vos_Q	26	90745	Warp_R	42	90818	Warp_RY	48
90548	Warp_R	42	90653	Vos_Q	26	90746	LV44_RD	115	90819	Warp_RY	48
90549	Warp_R	42	90654	Vos_Q	26	90747	LV44_RD	115	90820	Warp_QY	54
90550	Warp_R	43	90655	Vos_Q	26	90748	Warp_R	42	90821	Warp_QY	54
90551	Warp_R	43	90656	Vos_R	20	90749	Warp_R	42	90822	Warp_QY	54
90552	Warp_R	43	90657	Vos_R	20	90750	Warp_R	42	90823	Warp_QY	54
90553	Warp_R	43	90658	Vos_R	20	90751	Warp_R	42	90824	Warp_QY	54
90554	Quantum_R	34	90659	Vos_R	20	90752	Warp_R	42	90825	Warp_QY	54
90555	Quantum_R	34	90660	Vos_Q	27	90753	Warp_R	42	90826	Warp_QY	54
90556	Quantum_R	34	90661	Vos_Q	27	90754	Warp_Q	52	90827	Warp_QY	54
90557	Quantum_R	34	90662	Vos_R	21	90755	Warp_Q	52	90828	Warp_RY	48
90558	Quantum_R	34	90663	Vos_R	21	90756	Warp_Q	52	90829	Warp_RY	48
90559	Quantum_R	34	90664	Vos_Q	27	90757	Warp_Q	52	90830	Warp_RY	48
90560	Quantum_R	34	90665	Vos_Q	27	90758	Warp_Q	52	90831	Warp_RY	48
90561	Quantum_R	34	90666	Vos_Q	27	90759	Warp_Q	52	90832	Warp_RY	48
90562	Quantum_R	35	90667	Vos_Q	27	90760	Warp_Q	52	90833	Warp_RY	48
90563	Quantum_R	35	90668	Vos_R	21	90761	Warp_Q	52	90834	Warp_RY	48
90564	Quantum_R	35	90669	Vos_R	21	90762	Warp_R	43	90835	Warp_RY	48
90565	Quantum_R	35	90670	Vos_R	21	90763	Warp_R	43	90836	Warp_QY	54
90566	Quantum_RJ	36	90671	Vos_R	21	90764	Warp_R	43	90837	Warp_QY	54
90567	Quantum_RJ	36	90672	Vos_Q	27	90765	Warp_R	43	90838	Warp_QY	54
90568	Quantum_RJ	36	90673	Vos_Q	27	90766	Warp_R	43	90839	Warp_QY	54
90569	Quantum_RJ	36	90674	Vos_R	21	90767	Warp_R	43	90840	Warp_QY	54
90570	Quantum_RJ	36	90675	Vos_R	21	90768	Warp_Q	52	90841	Warp_QY	54

codes index

CODE	Product	Page	CODE	Product	Page	CODE	Product	Page	CODE	Product	Page
90842	Warp_QY	54	90931	Trunking system	339	91749	Loro_R	70	92120	Archiline_W	718
90843	Warp_QY	54	90933	Trunking system	339	91750	Loro_R	70	92124	Archiline_I	712
90844	Warp_RY	48	90935	Trunking system	339	91751	Loro_R	70	92125	Archiline_I	712
90845	Warp_RY	48	90943	Accessories	340	91752	Loro_R	70	92126	Archiline_I	712
90846	Warp_RY	48	90944	Accessories	340	91753	Loro_Q	74	92127	Archiline_F	706
90847	Warp_RY	48	90945	Accessories	340	91754	Loro_Q	74	92128	Archiline_F	706
90848	Warp_RY	48	90946	Accessories	340	91755	Loro_Q	74	92129	Archiline_F	706
90849	Warp_RY	48	90950	Accessories	340	91756	Loro_Q	74	92132	Archiline_A	710
90850	Warp_RY	48	90952	Trunking system	339	91769	LV44_RD	114	92134	Archiline_A	710
90851	Warp_RY	48	91200	Elin	430	91776	LV44_RD	114	92136	Archiline_A	710
90852	Warp_QY	54	91204	Loro_R	70	91777	LV44_RD	114	92138	Archiline_FL	708
90853	Warp_QY	54	91205	Loro_R	70	91778	LV44_RD	114	92139	Archiline_FL	708
90854	Warp_QY	54	91206	Loro_R	70	91779	LV44_RD	114	92142	Archiline_FL	708
90855	Warp_QY	54	91207	Loro_R	70	91780	LV44_RD	114	92143	Archiline_FL RGBW	708
90856	Warp_QY	54	91208	Loro_Q	74	91781	LV44_RD	115	92144	Archiline_FL RGBW	708
90857	Warp_QY	54	91209	Loro_Q	74	91783	LV44_RD	115	92145	Archiline_FL RGBW	708
90858	Warp_QY	54	91210	Loro_Q	74	91896	Anton_R	103	92203	Clivo	811
90859	Warp_QY	54	91211	Loro_Q	74	91926	Warp_R	46	92204	Clivo	811
90860	Warp_RY	48	91214	Eyelet65_R	789	91927	Warp_R	46	92230	Iris67	814
90861	Warp_RY	48	91215	Eyelet65_R	789	83841	Pixie_PIXEL	849	92231	Iris67	814
90862	Warp_RY	48	91216	Eyelet65_R	789	91992	Rada_R	124	92232	Iris67	814
90863	Warp_RY	48	91217	Eyelet65_Q	789	91996	Rada_R	124	92238	Quara_QI	538
90864	Warp_RY	48	91219	Eyelet65_Q	789	92000	Rada_R	124	92239	Quara_QI	538
90865	Warp_RY	48	91220	Eyelet65_Q	789	92004	Rada_R	124	92240	Quara_QI	538
90866	Warp_RY	48	91229	Illuminator	154	92023	Archicove	374	92256	Picrol	421
90867	Warp_RY	48	91230	Illuminator	154	92025	Archicove	374	92258	Picrol	421
90868	Warp_QY	54	91328	Baton_R	283	92038	Archiline_W	718	92259	Picrol	421
90869	Warp_QY	54	91330	Baton_Q	283	92040	Archiline_W	718	92260	Sand_R	547
90870	Warp_QY	54	91331	Shaker	801	92042	Archiline_W	718	92262	Sand_R	547
90871	Warp_QY	54	91338	Shaker	801	92044	Archiline_W	718	92271	Clip_R	544
90872	Warp_QY	54	91339	Aspho_Q	414	92046	Archiline_I	712	92272	Clip_R	544
90873	Warp_QY	54	91340	Aspho_R	412	92047	Archiline_I	712	92273	Clip_R	544
90874	Warp_QY	54	91341	Aspho_Q	414	92048	Archiline_I	712	92281	Clip_R	544
90875	Warp_QY	54	91342	Shaker	801	92049	Archiline_F	706	92282	Clip_R	544
90876	Warp_RY	49	91343	Aspho_Q	414	92050	Archiline_F	706	92283	Clip_R	544
90877	Warp_RY	49	91344	Aspho_R	412	92051	Archiline_F	706	92285	Beriel	426
90878	Warp_RY	49	91345	Aspho_Q	414	92052	Archiline_A	710	92291	Clip_Q	545
90879	Warp_RY	49	91346	Aspho_R	412	92054	Archiline_A	710	92292	Clip_Q	545
90880	Warp_RY	49	91347	Aspho_Q	414	92056	Archiline_A	710	92293	Clip_Q	545
90881	Warp_RY	49	91348	Bibok	409	92061	Beret_R	614	92301	Clip_Q	545
90882	Warp_RY	49	91349	Bibok	409	92065	Beret_R	614	92302	Clip_Q	545
90883	Warp_RY	49	91350	Bibok	409	92066	Beret_R	614	92303	Clip_Q	545
90884	Warp_QY	55	91352	Aspho_R	413	92067	Beret_R	614	92311	Clip_X	544
90885	Warp_QY	55	91354	Aspho_R	413	92068	Beret_R	614	92312	Clip_X	544
90886	Warp_QY	55	91362	Aspho_R	413	92069	Beret_Q	615	92313	Clip_X	544
90887	Warp_QY	55	91364	Picrol	421	92070	Archiline_W RGBW	719	92316	Petit_R	391
90888	Warp_QY	55	91365	Picrol	421	92072	Archiline_W RGBW	719	92318	Petit_R	391
90889	Warp_QY	55	91366	Bibok	409	92074	Archiline_W RGBW	719	92320	Petit_R	391
90890	Warp_QY	55	91398	Cob20_RX	100	92076	Beret_Q	615	92322	Petit_R	391
90891	Warp_QY	55	91402	Cob20_RX	100	92077	Beret_Q	615	92324	Petit_Q	391
90903	Trunking system	338	91410	Cob20_RX	100	92078	Archiline_W RGBW	719	92326	Petit_Q	391
90905	Trunking system	338	91414	Cob20_RX	100	92080	Archiline_I RGBW	713	92328	Petit_Q	391
90905E	Trunking system	338	91422	Alcor_AI	632	92081	Archiline_I RGBW	713	92330	Petit_Q	391
90907	Trunking system	338	91423	Alcor_AI	632	92082	Archiline_I RGBW	713	92405	Petit_R	392
90909	Trunking system	338	91424	Alcor_AI	632	92083	Archiline_F RGBW	707	92407	Petit_R	392
90911	Trunking system	338	91425	Alcor_AI	633	92084	Archiline_F RGBW	707	92409	Petit_R	392
90913	Trunking system	338	91426	Alcor_AI	633	92088	Beret_Q	615	92411	Petit_R	392
90915	Trunking system	338	91427	Alcor_AI	633	92092	Beret_Q	615	92413	Petit_Q	392
90917	Trunking system	338	91596	Myia	841	92093	Archiline_F RGBW	707	92415	Petit_Q	392
90919	Trunking system	339	91597	Myia	841	92100	Archiline_A RGBW	711	92417	Petit_Q	392
90921	Trunking system	339	91598	Myia	841	92104	Archiline_A RGBW	711	92419	Petit_Q	392
90923	Trunking system	339	91599	Vedette_Q	492	92108	Archiline_A RGBW	711	92432	Rada_Q	126
90925	Trunking system	339	91600	Vedette_Q	492	92112	Archiline_W	718	92434	Rada_Q	126
90927	Trunking system	339	91601	Vedette_Q	492	92114	Archiline_W	718	92513	Cut_R	541
90929	Trunking system	339	91602	Vedette_Q	492	92118	Archiline_W	718	92514	Cut_R	541

CODE	Product	Page	CODE	Product	Page	CODE	Product	Page	CODE	Product	Page
92558	Cut_Q	541	93834	Cob44_RJ	90	95619	Arcada	832	97069	Clivo_2	811
92559	Cut_Q	541	93835	Cob44_RJ	90	95623	Arcada	832	97070	Clivo_2	811
92619	Per	507	93836	Cob44_Q	91	95749	Arcada	832	97071	Clivo_2	811
92620	Per	507	93839	Cob44_Q	91	95750	Arcada	832	97072	Clivo_2	811
92621	Per	507	93840	Cob44_QJ	91	95751	Arcada	832	97073	Clivo_2	811
92622	Per	507	93843	Cob44_QJ	91	95822	Ice-cut_F	379	97086	Ilamt66	401
92671	Quara_RI	536	93844	Cob44_QJ	91	96150	Paseo_L	748	97088	Ilamt66	401
92672	Quara_QI	538	93847	Cob44_QJ	91	96151	Paseo_L	748	97090	LV54_RS	117
92681	Chim	533	93854	Rada_R	125	96152	Paseo_L	748	97092	LV54_RS	117
93099	Accessories	583	93862	Rada_R	125	96196	Paseo_X	753	97094	LV54_RS	117
93126	Beret_R	614	93986	Ilamt	401	96197	Paseo_X	753	97096	LV54_QS	118
93127	Beret_R	614	93988	Ilamt	401	96634	Anton_R	103	97098	LV54_QS	118
93128	Beret_R	614	93994	Paseo_L	749	96635	Anton_R	104	97100	LV54_QS	118
93132	Beret_2Q	615	93995	Paseo_L	749	96659	Concentrica_Q	623	97119	LV54_RS	117
93133	Beret_2Q	615	94020	Xenia_W	726	96660	Concentrica_Q	623	97130	Cob20_R	97
93134	Beret_2Q	615	94021	Paseo_L	749	96661	Concentrica_Q	623	97167	Envelope_W	520
93138	Beret_2Q	615	94022	Paseo_L	749	96740	Ice-Cut66	763	97169	Envelope_W	520
93139	Beret_2Q	615	94023	Xenia_W	726	96741	Ice-Cut66	763	97170	Envelope_W	520
93140	Beret_2Q	615	94059	Concentrica_Q	623	96742	Ice-Cut66	763	97172	Envelope_W	520
93141	Suelo_R	563	94060	Concentrica_Q	623	96801	Cob44_R	90	97185	Vedette_Q	492
93354	Cob44_Q	91	94061	Concentrica_Q	623	96802	Cob44_R	90	97186	Vedette_Q	492
93355	Cob44_Q	91	94110	Archicove	374	96803	Cob44_RJ	90	97187	Vedette_Q	492
93407	Loro_RJ	72	94115	Archicove	374	96804	Cob44_RJ	90	97188	Vedette_Q	492
93411	Loro_RJ	72	94137	Zalex	617	96809	Cob20_RJ	96	97189	Ghilea	423
93413	Loro_RJ	72	94138	Zalex	617	96813	Cob20_R	96	97255	Paseo_X	753
93418	Loro_RJ	72	94167	Ardilla66	505	96819	Cob20_R	97	97256	Paseo_X	753
93422	Loro_RJ	73	94168	Ardilla66	505	96827	Cob20_Q	98	97270	Gardener	804
93428	Loro_RJ	73	94169	Ardilla66	505	96831	Cob20_Q	98	97271	Gardener	804
93429	Loro_RJ	73	94170	Ardilla66	505	96837	Cob20_Q	99	97272	Gardener	804
93431	Loro_RJ	73	94204	Ardilla66	505	96916	Footpad Flat	639	97315	Sub	875
93443	Loro_RJ	72	94208	Ardilla66	505	96966	Envelope_4	389	97317	Sub	875
93444	Loro_RJ	72	94209	Ardilla66	505	96968	Envelope_4	389	97318	Iris67	814
93446	Loro_RJ	72	94214	Ardilla66	505	96969	Envelope_4	389	97319	Iris67	814
93449	Loro_RJ	72	94215	Ardilla66	505	96971	Envelope_2	389	97320	Iris67	814
93450	Loro_RJ	73	94223	Ardilla66	505	96973	Envelope_2	389	97321	Iris67	814
93451	Loro_RJ	73	94224	Ardilla66	505	96974	Envelope_2	389	97322	Iris67	814
93452	Loro_RJ	73	94411	Ardilla66	505	96976	Envelope_1	520	97323	Iris67	814
93460	Loro_RJ	73	94415	Fasim	620	96977	Envelope_1	520	97324	Iris67	814
93508	Quara_R	395	94586	Anton_R	104	96978	Envelope_1	389	97325	Iris67	814
93513	Quara_R	395	94592	Anton_RJ	107	96979	Envelope_1	520	97326	Iris67	814
93515	Quara_R	395	94659	Fasim	620	96981	Shaker	801	97336	Eyelet_Q	441
93516	Quara_R	395	95068	Periskop RGB	794	96982	Shaker	801	97337	Eyelet_Q	441
93517	Quara_Q	395	95126	Periskop RGB	794	96983	Shaker	801	97338	Eyelet_Q	441
93518	Quara_Q	395	95141	Periskop RGB	794	96984	Eyelet_R	441	97353	Alcor_R	627
93519	Quara_Q	395	95151	Narcissus	807	96985	Eyelet_R	441	97354	Alcor_R	627
93520	Quara_Q	395	95152	Narcissus	807	96986	Eyelet_R	441	97355	Alcor_R	627
93521	Dot_R	397	95330	Periskop RGB	794	96989	Shaker	801	97356	Alcor_R	627
93522	Dot_Q	397	95346	Periskop	795	97044	Ghilea	423	97357	Loop66	843
93566	Ilamt	401	95347	Periskop	795	97045	Ghilea	423	97387	Gardener	804
93594	Xenia_W	728	95348	Periskop	795	97047	Ghilea	423	97402	Anton_RJ	106
93595	Xenia_W	728	95349	Periskop	795	97048	Vedette_Q	492	97404	Anton_RJ	106
93596	Xenia_W	728	95366	Periskop	796	97049	Vedette_Q	492	97418	Anton_R	103
93605	Xenia_W	728	95368	Periskop	796	97050	Vedette_Q	492	97427	Anton_RJ	107
93688	Xenia_W	726	95370	Periskop	796	97051	Vedette_Q	492	97611	Paseo_X	753
93689	Xenia_W	726	95378	Periskop	796	97052	Vedette_Q	492	97612	Paseo_X	753
93690	Xenia_W	728	95436	Ice-cut_F	379	97053	Vedette_Q	492	97673	Paseo_L	748
93691	Xenia_W	728	95437	Ice-cut_F	379	97054	Vedette_Q	492	97674	Paseo_L	748
93755	Xenia_W	728	95438	Ice-cut_F	379	97055	Vedette_Q	492	97675	Paseo_L	748
93785	Xenia_W	728	95454	Arcada	832	97065	Loop66	843	97695	Loro_R	70
93786	Xenia_W	726	95458	Arcada	832	97066	Loop66	843	97696	Loro_R	70
93825	Xenia_W	726	95474	Orma_FO	596	97067	Loop66	843	97697	Loro_R	70
93828	Xenia_W	726	95475	Orma_FO	596	97068	Clivo_2	811	97698	Loro_R	70
93829	Xenia_W	726	95476	Orma_FO	596				97699	Loro_Q	74
93832	Cob44_R	90	95612	Arcada	832				97700	Loro_Q	74
93833	Cob44_R	90	95616	Arcada	832				97701	Loro_Q	74

codes index

CODE	Product	Page	CODE	Product	Page	CODE	Product	Page	CODE	Product	Page
97702	Loro_Q	74			742			742	98577	Accessories	525
97710	HV44	119			754			754	98624	Accessories	789
97711	HV44	119	98149	Accessories	761			525	98635	Ribbon Plus	900
97712	HV44	119			763			525	98636	Ribbon Plus	900
97714	Intake_L	525	98291	Accessories	610			61	98637	Ribbon Plus	900
97715	Inatle_L	525	98292	Accessories	610			63	98638	Ribbon Plus	900
97730	HV44	119	98355	Accessories	755			64	98639	Ribbon Plus	900
97731	HV44	119	98356	Accessories	755			62	98640	Ribbon Plus	900
97732	HV44	119	98357	Accessories	755			63			721
97797	Beret_X	614	98367	Accessories	756			64	98660	Accessories	821
97798	Beret_X	614	98368	Accessories	756			60			721
97799	Beret_X	614	98369	Accessories	756			64	98661	Accessories	821
97800	Beret_X	614	98373	Accessories	909			61			721
97801	Beret_X	614	98374	Accessories	756			64	98662	Accessories	821
97846	Ice-cut_F	379	98375	Accessories	756			83			721
97847	Ice-cut_F	379	98376	Accessories	756			154	98663	Accessories	821
97848	Ice-cut_F	379	98379	Accessories	910			156			721
97849	Ice-cut_F	379	98383	Accessories	910			154	98669	Accessories	789
97920	Loro_R	70	98384	Accessories	910			156	98671	Accessories	715
97921	Loro_R	70	98395	Accessories	916			154	98672	Accessories	715
97924	Loro_R	70			379			156	98673	Accessories	715
97925	Loro_R	70	98398	Accessories	763			811	98675	Accessories	721
97940	Loro_Q	74			917			801	98676	Accessories	721
97941	Loro_Q	74	98402	Accessories	623			60	98677	Accessories	721
97944	Loro_Q	74	98418	Accessories	916			64	98699	Accessories	375
97945	Loro_Q	74	98419	Accessories	916			60	98713	Accessories	375
98009	Accessories	533	98420	Accessories	916			64	98716	Accessories	375
98011	Ribbon	906			334			60	98724	Accessories	715
98012	Ribbon	906	98428	Accessories	335			64	98725	Accessories	715
98017	Ribbon RGB	907			334			61	98726	Accessories	715
98025	Dropper RGB	908	98429	Accessories	335			64	98771	Accessories	757
98033	Silicone_C	909			335			61	98772	Accessories	757
98042	Silicone_C	909	98430	Accessories	755			64	98773	Accessories	757
98049	Accessories	421	98434	Accessories	756			61	98774	PU_C Plus	902
98050	Accessories	539	98435	Accessories	756			64	98775	PU_C Plus	902
98060	Accessories	875			124			61	98776	PU_C Plus	902
98077	Ribbon	906			125			63	98777	PU_C Plus	902
98078	Ribbon	906			126			64	98778	PU_C Plus	902
98083	Ribbon	906	98436	Accessories	924			61	98779	PU_C Plus	902
98084	Ribbon	906			925			63	98781	Accessories	375
98092	Dropper	908			926			64	98782	Accessories	742
98111	Accessories	521			927			61	98783	Accessories	742
		807			936			63	98784	Accessories	742
		811			742			64	98785	Accessories	742
98112	Accessories	815	98437	Accessories	761			62	98836	Accessories	756
		583			763			63	98837	Accessories	756
98121	Accessories	633	98464	Accessories	756			62	98838	Accessories	756
		583	98465	Accessories	756			63	98839	Accessories	756
98122	Accessories	633	98466	Accessories	755			64	98840	Accessories	756
		617	98467	Accessories	755			62	98841	Accessories	756
98133	Accessories	617	98468	Accessories	755			63	98842	Accessories	756
		617	98469	Accessories	755			64	98843	Accessories	756
98140	Electronics	951	98470	Accessories	755			907	98844	Accessories	756
		951	98471	Accessories	755			799	98845	Accessories	756
		721	98472	Accessories	755			801	98876	Accessories	755
98146	Accessories	820	98473	Accessories	755			910	98877	Accessories	623
		821	98474	Accessories	755			910	98878	Accessories	375
		721	98475	Accessories	757			755	98879	Accessories	375
98147	Accessories	820			742			755	98880	Ribbon	906
		821			754			755	98881	Ribbon	906
		875	98493	Accessories	950			906	98882	Ribbon	906
98148	Accessories	881			952			906	98885	Accessories	915
		895			954			906	98886	Accessories	915
								908	98887	Accessories	915
								908	98888	Accessories	915

CODE	Product	Page	CODE	Product	Page	CODE	Product	Page	CODE	Product	Page
98889	Accessories	915	98951	Accessories	742	99176	Electronics	937	99362	Electronics	929
98890	Accessories	915	98952	Accessories	742	99177	Electronics	937	99370	Electronics	924
98891	Accessories	912	98953	Accessories	742	99179	Electronics	937			932
98892	Accessories	912	98954	Accessories	912	99181	Electronics	937			944
98893	Accessories	913	98955	Accessories	912	99183	Electronics	937	99371	Electronics	945
98894	Accessories	913	98956	Accessories	916	99184	Electronics	953			950
98895	Accessories	913	98957	Accessories	715	99185	Electronics	937	99372	Electronics	932
98896	Accessories	913	98964	Accessories	903	99186	Electronics	937	99373	Electronics	929
98897	Accessories	913	98965	Accessories	913	99195	Electronics	924			931
		913	98966	Accessories	799	99198	Electronics	924			934
98898	Accessories	914	98967	Accessories	799			742	99374	Electronics	944
		913	98968	Accessories	799			754			945
98899	Accessories	914	98969	Accessories	799	99216	Accessories	761			950
		913	98970	Accessories	799			763	99375	Electronics	924
98900	Accessories	914	98971	Accessories	799			837	99376	Electronics	924
98901	Accessories	913	98972	Accessories	445	99229	Accessories	960	99377	Electronics	924
98902	Accessories	913	98973	Accessories	445	99234	Electronics	953	99379	Accessories	961
98903	Accessories	916	98974	Accessories	445	99235	Electronics	953	99381	Electronics	956
98904	Accessories	916	98975	Accessories	445	99237	Accessories	960	99382	Electronics	956
98905	Accessories	916	98976	Accessories	445	99239	Electronics	925	99383	Electronics	956
98906	Accessories	914	98977	Accessories	445	99243	Electronics	924	99384	Electronics	956
98907	Accessories	914	98978	Accessories	445	99260	Electronics	924	99385	Electronics	956
98908	Accessories	915	98979	Accessories	445	99261	Electronics	925	99386	Electronics	956
98909	Accessories	915	98980	Accessories	445	99262	Electronics	927	99387	Electronics	954
98910	Accessories	915	98981	Accessories	445	99269	Electronics	937	99388	Electronics	954
98911	Accessories	915	98982	Accessories	445	99278	Electronics	951	99390	Accessories	962
98912	Accessories	915	98983	Accessories	445	99305	Electronics	948	99479	Accessories	149
98913	Accessories	915			956	99307	Electronics	924	99485	Accessories	152
98914	Accessories	915	98985	Electronics	962	99308	Electronics	947	99486	Accessories	152
98915	Accessories	915			962			922	99487	Accessories	152
98916	Accessories	914	98986	Accessories	961			938	99488	Accessories	152
98917	Accessories	914			881	99309	Electronics	939	99489	Accessories	152
98918	Accessories	914	98990	Accessories	895			946	99490	Accessories	152
98919	Accessories	914			961			947	99491	Accessories	153
98920	Accessories	914	98991	Accessories	961			948	99492	Accessories	153
98921	Accessories	914	98992	Accessories	397	99310	Electronics	946	99494	Accessories	153
98922	Accessories	914			742	99311	Electronics	947	99495	Accessories	153
98925	Accessories	912	98993	Accessories	754	99330	Electronics	928	99497	Accessories	155
98928	Accessories	912			742			934	99498	Accessories	155
98929	Accessories	912	98994	Accessories	754			941	99499	Accessories	155
98930	Accessories	912			754	99331	Electronics	945	99500	Accessories	155
98931	Accessories	912	99000	Accessories	911			950	99501	Accessories	155
98932	Accessories	912	99001	Accessories	911	99332	Electronics	943	99502	Accessories	155
98933	Accessories	912	99002	Accessories	960	99333	Electronics	950	99503	Accessories	445
98934	Accessories	912	99045	Electronics	953	99340	Electronics	937	99504	Accessories	445
98936	Accessories	912	99046	Electronics	953	99341	Electronics	923	99505	Accessories	445
98937	Accessories	915	99050	Electronics	952	99342	Electronics	937	99506	Accessories	445
98938	Accessories	915			721	99344	Electronics	928	99510	Accessories	149
98939	Accessories	915	99057	Accessories	820	99345	Electronics	928			881
98940	Accessories	915			821			952	99520	Accessories	895
		912	99074	Electronics	935			954			895
98941	Accessories	913			934	99346	Electronics	956	99521	Accessories	895
		916	99077	Electronics	935			961	99536	Accessories	894
		912			925	99348	Accessories	960	99537	Accessories	894
98942	Accessories	913	99093	Electronics	925	99349	Accessories	960	99538	Accessories	895
		916	99105	Electronics	925	99350	Accessories	960	99539	Accessories	895
		912	99106	Electronics	925	99351	Accessories	960	99540	Electronics	945
98943	Accessories	913	99112	Electronics	925	99352	Accessories	960	99541	Accessories	894
		916	99115	Electronics	927	99353	Accessories	960	99543	Rubber 3D_PRO	880
		912	99126	Electronics	924			456	99544	Rubber 3D_PRO	880
98944	Accessories	913	99128	Electronics	924	99355	Electronics	958	99545	Rubber 3D_PRO	880
		912	99129	Electronics	924			910	99549	Accessories	894
98945	Ribbon Plus	900	99135	Electronics	925	99357	Accessories	910			152
98946	Ribbon Plus	900	99141	Electronics	926	99358	Accessories	910	99550	Accessories	157
98948	Ribbon Plus	900	99146	Electronics	925	99360	Electronics	926			155
98949	Accessories	741	99147	Electronics	925	99361	Electronics	927	99551	Accessories	157
98950	Accessories	395	99175	Electronics	937						

codes index

CODE	Product	Page	CODE	Product	Page	CODE	Product	Page	CODE	Product	Page
99552	Accessories	152	99685	Accessories	583	99773	Accessories	185			149
	Accessories	157		99688	Accessories			895			275
99553	Accessories	155	99689	Accessories	895	99774	Accessories	185	99796	Accessories	197
		157	99692	Accessories	895			275			213
99554	Accessories	152	99693	Accessories	895	99775	Accessories	185			220
		157	99694	Electronics	945			275			247
99555	Accessories	155	99695	Electronics	945	99776	Accessories	185			275
		157	99696	Electronics	945			275			149
99556	Accessories	266	99700	Electronics	942	99777	Accessories	185			185
		529	99701	Electronics	943			275			197
99560	Accessories	610			942	99778	Accessories	742	99797	Accessories	213
		154	99701	Electronics	943			149			220
99561	Accessories	156			942			185			247
		154	99702	Electronics	943			197			275
99562	Accessories	156	99703	Electronics	944	99779	Accessories	213			149
		529	99708	Electronics	930			220			185
99563	Accessories	610	99709	Electronics	930			247	99798	Accessories	213
		529	99710	Electronics	930			275			220
99564	Accessories	610	99711	Electronics	930			149			220
		274	99712	Electronics	930			185			247
99569	Accessories	274	99713	Electronics	930	99780	Accessories	213			275
99575	Electronics	955	99714	Electronics	927			220			149
99576	Electronics	955	99715	Electronics	928			247			185
99577	Electronics	955	99716	Electronics	936			275			197
99578	Electronics	957	99717	Electronics	925			149	99799	Accessories	213
99579	Electronics	957	99718	Electronics	925			185			220
99584	Accessories	266	99721	Electronics	928			197			247
99588	Dropper	908	99722	Electronics	943			275			275
99590	Dropper	908			934	99781	Accessories	213	99800	Accessories	309
99592	Dropper	908	99723	Electronics	935			220			220
99598	Silicone_C	909			933			247	99801	Accessories	311
99600	Silicone_C	909	99725	Electronics	933			275			799
99602	Silicone_C	909	99726	Electronics	938			149	99802	Accessories	583
99608	Ribbon	906	99727	Electronics	939			185			583
99610	Ribbon	906	99728	Electronics	938	99782	Accessories	213			184
99612	Ribbon	906	99729	Electronics	939			220			274
99620	Silicone_C	909	99730	Electronics	928			247	99805	Accessories	184
99622	Silicone_C	909	99731	Electronics	928			275			274
99628	Dropper	908	99732	Electronics	927			149	99806	Accessories	184
99630	Dropper	908	99733	Electronics	927			185			274
99632	Dropper	908	99734	Electronics	924			197	99807	Accessories	148
		529	99735	Electronics	924			275			157
99650	Accessories	610	99738	Electronics	928			185			184
		529	99739	Electronics	927			197			197
99651	Accessories	610	99740	Electronics	924	99783	Accessories	213	99808	Accessories	213
		529	99741	Electronics	944			220			220
99652	Accessories	610	99742	Electronics	944			247			247
		955	99743	Electronics	944			941			274
99657	Electronics	955	99744	Accessories	521	99784	Electronics	944			148
		956	99745	Accessories	521			950			157
99660	Electronics	935	99746	Accessories	789			941			184
99670	Ribbon Plus RGBW	901	99747	Accessories	583			954			197
99671	Ribbon Plus WT	901	99748	Accessories	721	99785	Electronics	941	99809	Accessories	213
99672	Ribbon Plus DW	901	99752	Play Outer-casing	139			945			220
99673	Accessories	467	99753	Play Outer-casing	139	99786	Electronics	943			247
99674	Accessories	467	99754	Play Outer-casing	139			941			274
99675	Accessories	467	99755	Play caps	139			149			148
99676	Accessories	583	99756	Play caps	139			185			157
99677	Accessories	583	99760	Accessories	715			197			184
99678	Accessories	871	99761	Accessories	741			275			197
99679	Accessories	871	99762	Accessories	741	99795	Accessories	213	99810	Accessories	213
99680	Accessories	583	99763	Accessories	741			220			220
99681	Accessories	583	99764	Accessories	741			247			247
99682	Electronics	932	99765	Accessories	741			275			274
99683	Electronics	933	99766	Accessories	741				99818	Accessories	741
99684	Accessories	583									

CODE	Product	Page	CODE	Product	Page	CODE	Product	Page	CODE	Product	Page
99820	Accessories	741	99860	Accessories	327	99919	Accessories	741			
99821	Accessories	741	99861	Accessories	327			155			
		721	99862	Accessories	327	99920	Accessories	157			
99822	Accessories	820	99863	Accessories	327			155			
		721	99864	Accessories	327	99921	Accessories	157			
99823	Accessories	820	99865	Accessories	327	99922	Accessories	610			
		721	99866	Accessories	327	99923	Accessories	610			
99824	Accessories	820	99867	Accessories	327	99924	Accessories	610			
		721	99868	Accessories	327	99925	Accessories	610			
99825	Accessories	820	99869	Accessories	327	99926	Accessories	741			
		721	99870	Accessories	327	99927	Creek Accessories	218			
99826	Accessories	820	99871	Accessories	327	99928	Creek Accessories	218			
		148	99872	Accessories	327	99929	Creek Accessories	218			
		184	99873	Accessories	327	99932	Accessories	837			
		197	99874	Accessories	327	99933	Accessories	837			
99827	Accessories	213	99875	Accessories	327	99935	Navata Base	212			
		220	99876	Accessories	327	99936	Navata Base	212			
		247	99877	Accessories	327	99938	Navata Base	212			
		274	99878	Accessories	327	99940	Navata Base	212			
		148			742	99941	Navata Base	212			
		184	99879	Accessories	754	99943	Navata Base	212			
		197			86	99954	Accessories	249			
99828	Accessories	213	99888	Accessories	87	99955	Accessories	249			
		220			86	99956	Accessories	249			
		247	99889	Accessories	87	99957	Accessories	249			
		274			87	99958	Accessories	249			
		148			86	99959	Accessories	249			
		184	99890	Accessories	87	99960	Accessories	249			
		197			86	99961	Accessories	249			
99829	Accessories	213	99891	Accessories	87	99962	Accessories	249			
		220			86	99963	Accessories	249			
		247	99892	Accessories	87	99964	Accessories	249			
		274			86	99965	Accessories	249			
		315	99893	Accessories	87	99966	Accessories	249			
99840	Accessories	321			153	99967	Accessories	249			
		149	99896	Accessories	157	99968	Accessories	249			
		197			153	99970	Accessories	266			
99841	Accessories	213	99897	Accessories	157	99971	Accessories	266			
		220			157	99972	Accessories	741			
		149	99898	Accessories	266	99976	Accessories	917			
		197			86	99977	Accessories	917			
99842	Accessories	213	99899	Accessories	87	99978	Accessories	917			
		220			86	99979	Accessories	917			
		148	99900	Accessories	87			153			
		197			86	99981	Accessories	157			
99843	Accessories	213			87			315			
		220	99902	Accessories	87	99982	Accessories	321			
		148			86	99983	Accessories	912			
		197	99903	Accessories	87	99984	Accessories	912			
99844	Accessories	213			87	99986	Accessories	912			
		220	99904	Accessories	87	99988	Accessories	912			
		20			913	99989	Accessories	914			
99847	Accessories	21	99905	Accessories	913	99998	Accessories	915			
		20	99906	Accessories	913	99999	Accessories	916			
99848	Accessories	21	99907	Accessories	913			457			
		21	99908	Accessories	913	KIT0014	Electronics	959			
99849	Accessories	21	99909	Accessories	916	KIT0027	Electronics	945			
99850	Accessories	387	99910	Accessories	916						
99853	Accessories	185	99911	Accessories	916						
		529	99912	Accessories	741						
99855	Accessories	610	99913	Accessories	741						
		529	99914	Accessories	741						
99856	Accessories	610	99915	Accessories	741						
		839	99916	Accessories	741						
		529	99917	Accessories	837						
99857	Accessories	610	99918	Accessories	741						

Addresses

Linea Light HQ Italy

via della Fornace, 59 z.i.
31023 Castelmolin di Resana (TV) - Italy
Phone: +39 0423 7868
Fax: +39 0423 786900
info@linealight.com

LightVillage Milano

Exhibition Area Only
via Morimondo, 26 int. 17G
20143 Milano - Italy
Phone: +39 02 36750915
Fax: +39 02 36750915
milano@lightvillage.it

Linea Light Roma

Via Stendhal, 22
00144 Roma - Italy
Phone: +39 06 5935106
info@linealightroma.com

Linea Light UK

Suite 109 - The Business Design Centre
52 Upper Street - Islington N10QH
London - UK
Phone: +44 0203 6371983
info@linealight-uk.com

Linea Light France

Z.A. Heiden Est, 12 rue des Pays-Bas
68310 Wittelsheim - France
Phone: +33 389 75 52 23
Fax: +33 389 75 59 07
info@linealight.fr

Linea Light Deutschland

Aktienstraße 214
45473 Mülheim Ruhr - Germany
Phone: +49 208 299979-0
Fax: +49 208 299979-10
service@linealight.de

Linea Light USA - Inter Lux

3741 Commerce Drive
Suites 306-308
Baltimore, MD 21227 - USA
Phone: +1 410 381 1497
Fax: +1 410 381 1589
answers@inter-lux.com

Linea Light Russia

Design Center Artplay
Nizhnyaya Syromyatnicheskaya 10/2 enter B,
3rd floor, office 14
105120 Moscow - Russia Federation
Phone: +7 495 639 9941
info@linealight.ru

Linea Light Spain

C/ Longares, 48
28022 Madrid - Spain
Phone: +34 912534773
info@linealigh.es

Linea Light Singapore

21 Kaki Bukit Place, 5th Fl.
Eunos Techpark Singapore
416199 Singapore
Phone: +65-6908 5758
info.sg@linealight.com

Linea Light GCC

Jumeirah Lake Towers
JBC2 - 35th Floor Cluster V - Dubai - UAE
P.O. Box 125902
Phone: +971 4 4218275
Fax: +971 4 4218274
info@linealight.ae

Linea Light Asia - Pacific

No. 7, Nanyi Huayuan Road, Industry Avenue,
528478 Xiaolan Town, Zhongshan City,
Guangdong Province - China
Phone: +86 760 87618355
Fax: +86 760 87553990
info@linealight.cn

Art direction

Linea Light Group Marketing Dept.

Printed in Italy

February 2021

Photography and post production

Matteo Lavazza Seranto photography studio

Mural illustration

Emanuele Nicoletti Serra

Furniture

Faram 1957

Thanks to

Martino Lorenzon for painted on page: 167

And



linealight.com

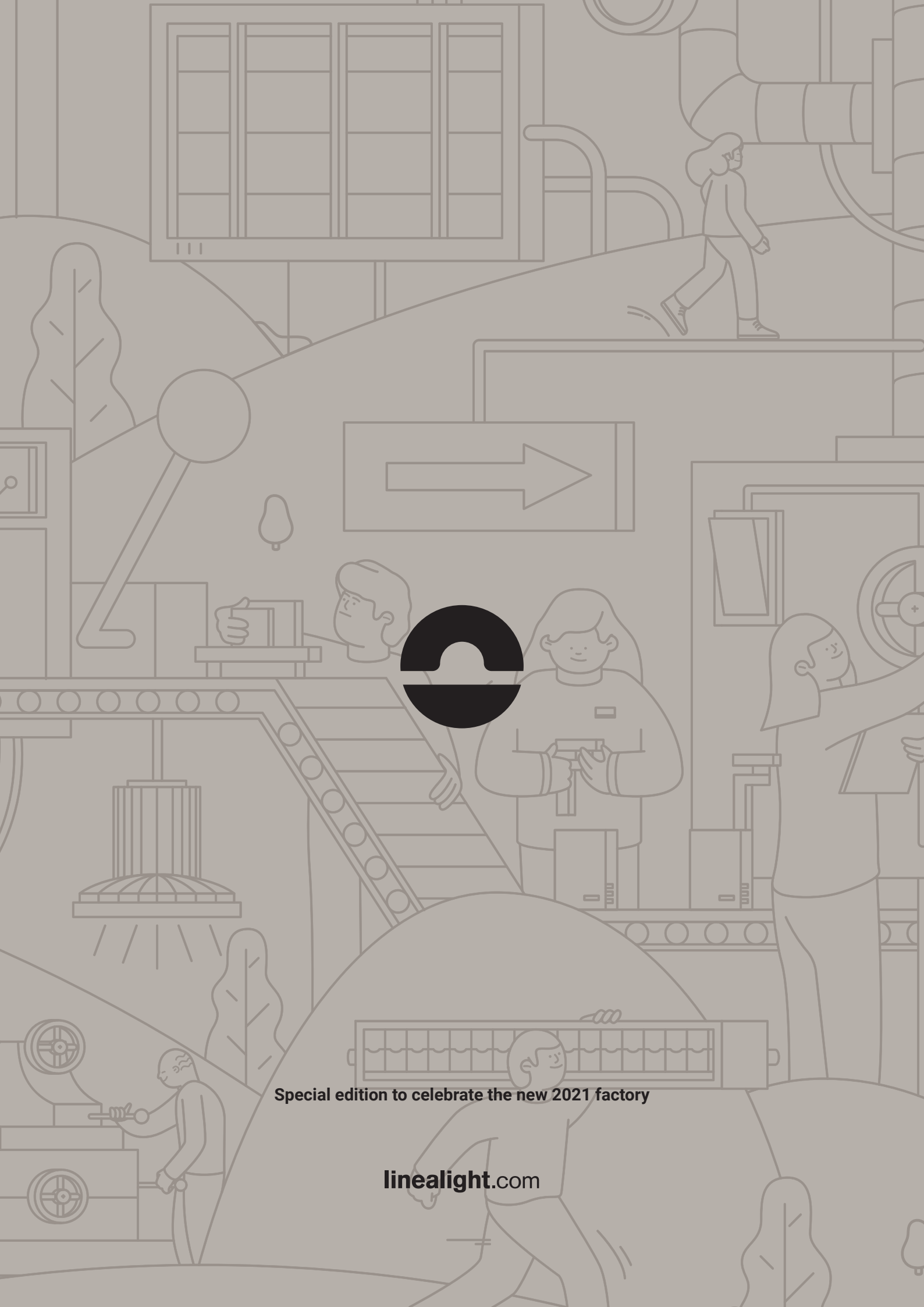

Special edition to celebrate the new 2021 factory

linealight.com