

# LIVIN' LIGHT

PROFESSIONAL **LED** SOLUTIONS FOR **FURNITURE**

**linealightgroup**







LINEA LIGHT GROUP racconta una storia di impegno, esperienza e competenza tecnica nella progettazione e realizzazione di prodotti e soluzioni per le diverse esigenze dell'illuminazione. L'azienda, impegnata da oltre 30 anni sul fronte della qualità e della ricerca, si configura come punto di riferimento nel settore dell'illuminazione a LED. In quest'ottica abbiamo deciso di creare LIVIN'LIGHT, una linea di prodotti pensati per il mondo del mobile, un settore in cui l'illuminazione gioca un ruolo importante, mettendo in risalto i particolari e migliorando l'ambiente in cui viviamo tutti i giorni.

*LINEA LIGHT GROUP tells a story of commitment, experience and skill in the design and implementation of products and solutions for every lighting need. The company, committed over 30 years in quality and research, is emerging as benchmark for the LED lighting industry. With this purpose we decided to create LIVIN'LIGHT, a line of products designed for the world of furniture, an area where lighting plays an important role, highlighting the details and improving the environment we are living every day.*

# LIVIN' LIGHT

LINEA LIGHT GROUP è sempre attenta alla qualità e al servizio: non ci limitiamo al solo assemblaggio del prodotto ma lo curiamo in tutti i dettagli fin dall'acquisto della materia prima adottando standard di qualità elevati per garantire al cliente un prodotto perfetto nato per valorizzare qualsiasi contesto applicativo. LINEA LIGHT GROUP progetta e sviluppa internamente i suoi prodotti. Per questo, oltre a garantire la produzione Made in Italy, offre un veloce e preciso servizio su misura. La qualità dei nostri prodotti è supportata dall'innovazione tecnologica che ne ottimizza il funzionamento. LINEA LIGHT GROUP, con la sua divisione elettronica, progetta e sviluppa internamente i sistemi di alimentazione: adottando elevati standard di qualità, garantisce un prodotto che possa realmente supportare la lunga durata del LED nel tempo. Grazie all'impiego della migliore componentistica e della più sofisticata tecnologia di assemblaggio offriamo un prodotto dalle caratteristiche tecniche ottimali rispettando tutti gli aspetti normativi come la sicurezza elettrica, la compatibilità elettromagnetica e la produzione a basso impatto ambientale.

*LINEA LIGHT GROUP is always attentive to quality and service: we do not stop at just assembling the product, but we manage it down to the smallest detail from the time the raw material is purchased, implementing high quality standards in order to guarantee the customer a perfectly made product to enhance any application setting.*

*LINEA LIGHT GROUP designs and develops its products in-house. Therefore in addition to providing 'Made in Italy' production, we offer fast and accurate customer service. LINEA LIGHT GROUP product quality is supported by technological innovation which optimises its operation. We design and develop our own drivers in our electronics department, thereby ensuring high quality standards, and guaranteeing high quality performance and long life for our LED lighting products. Thanks to the use of the best available components and the most sophisticated assembly technology, we provide a product with outstanding technical characteristics in compliance with all regulatory aspects such as electrical safety, electromagnetic compatibility and environmentally friendly production.*

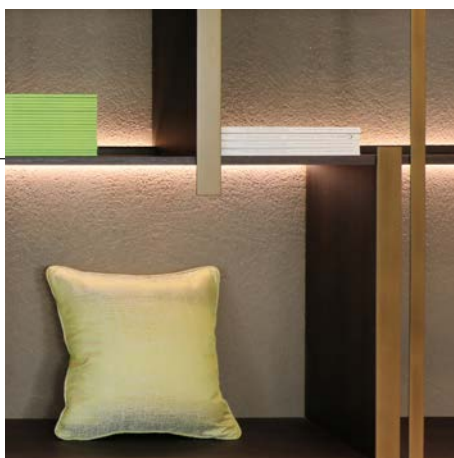

# LIVIN' GREEN

L'efficienza della tecnologia a LED, unitamente all'utilizzo di materiali e componenti riciclabili e smaltibili, consente di apportare un significativo contributo alla riduzione delle emissioni di CO<sub>2</sub>, garantendo così una maggiore salubrità dell'aria ed un futuro migliore. LINEA LIGHT GROUP compie un ulteriore passo avanti verso un mondo più pulito: grazie all'utilizzo di pannelli fotovoltaici di propria produzione, l'Azienda sta attuando l'ambizioso progetto che le permetterà di divenire quasi totalmente autosufficiente a livello energetico, con una produzione di 30 kW di energia pulita e il concreto obiettivo di 1,5 MW annui nell'immediato futuro.

*We combine highly efficient LED technology with recyclable and disposable materials and components, thereby contributing to a significant reduction of CO<sub>2</sub> emissions. LINEA LIGHT GROUP has also taken a further step towards a cleaner world: we are using our own photovoltaic panels to carry out an ambitious project that will allow us to be almost totally energy self-sufficient. We are producing 30 kW of clean energy and looking forward to meeting the goal of 1.5 MW per year in the near future.*

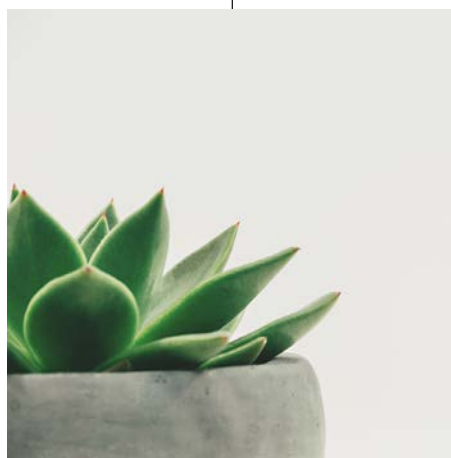



INDEX

## SURFACE PROFILES

page 8-9

---

## RECESSED PROFILES

page 62-63

---

## RECESSED SPOTLIGHT

page 112-113

---

## STRIPLLED CIRCUITS

page 120-121

---

## BATHROOM SOLUTIONS

page 130-131

---

## ELECTRONICS

SUPPLIES SENSOR & ACCESSORIES

page 138-139

---

CRITERI  
DI LETTURA

HOW  
TO READ

PAGINA ARTICOLO  
PRODUCT PAGE

### Slim P

accensione e spegnimento tramite passaggio di una mano nei pressi del sensore (senza contatto)  
power on and off by moving a hand close to the sensor (without touch)



FINITURA FINISH	L mm	kg	Slim P BASIC			Slim P PLUS			Slim P TOP			COLORE OTTICA COLOUR OPTIC	
			LED's	POTENZA POWER	CODICE CODE	LED's	POTENZA POWER	CODICE CODE	LED's	POTENZA POWER	CODICE CODE	COLORE COLOUR	OTTICA OPTIC
AN	447 mm	0,14	18	1,4 W	ER0594	42	3,4 W	ER0598	84	6,7 W	ER0602	C	5000°K
	597 mm	0,17	30	2,4 W	ER0595	60	4,8 W	ER0599	120	9,6 W	ER0603	N	4000°K
	887 mm	0,26	48	3,8 W	ER0596	96	7,7 W	ER0600	192	15,4 W	ER0604	W	2700°K
	1197 mm	0,35	66	5,3 W	ER0597	132	10,6 W	ER0601	264	21,1 W	ER0605		

NOME ARTICOLO / VERSIONE  
PRODUCT NAME / VERSION

DESCRIZIONE  
DESCRIPTION

PITTOGRAMMI  
PICTOGRAMS

FINITURE  
FINISH

CODICE  
CODE

DISEGNO TECNICO  
TECHNICAL DRAWING

FOTO ARTICOLO  
PRODUCT PHOTO

ICONA VERSIONE  
VERSION ICON

COLORI E OTTICHE DISPONIBILI  
AVAILABLE COLOURS AND OPTICS

---

### Slim S

accensione tramite sensore di presenza PIR, spegnimento automatico dopo 30"  
power on through PIR presence detector, automatic switching off after 30"



FINITURA FINISH	L mm	kg	Slim S BASIC			Slim S PLUS			Slim S TOP			COLORE OTTICA COLOUR OPTIC	
			LED's	POTENZA POWER	CODICE CODE	LED's	POTENZA POWER	CODICE CODE	LED's	POTENZA POWER	CODICE CODE	COLORE COLOUR	OTTICA OPTIC
AN	400 mm	0,13	18	1,4 W	ER0501	36	2,9 W	ER0505	72	5,8 W	ER0509	C	5000°K
	550 mm	0,16	24	1,9 W	ER0502	54	4,3 W	ER0506	108	8,6 W	ER0510	N	4000°K
	850 mm	0,25	42	3,4 W	ER0503	80	7,2 W	ER0507	180	14,4 W	ER0511	W	2700°K
	1150 mm	0,34	60	4,8 W	ER0504	126	10,1 W	ER0508	252	20,2 W	ER0512		

DISEGNO TECNICO  
TECHNICAL DRAWING

FOTO ARTICOLO  
PRODUCT PHOTO

ICONA VERSIONE  
VERSION ICON

COLORI E OTTICHE DISPONIBILI  
AVAILABLE COLOURS AND OPTICS

COMPOSIZIONE CODICE  
CODE COMPOSITION

FINITURA FINISH	L mm	kg	Slim BASIC			Slim PLUS			Slim TOP			COLORE OTTICA COLOUR OPTICS	
			LED's	POTENZA POWER	CODICE CODE	LED's	POTENZA POWER	CODICE CODE	LED's	POTENZA POWER	CODICE CODE	COLORE COLOUR	OTTICA OPTICS
AN	400 mm	0,13	18	1,4 W	ER0475	42	3,4 W	ER0480	84	6,7 W	ER0485	C	5000°K
	550 mm	0,16	30	2,4 W	ER0476	60	4,8 W	ER0481	120	9,6 W	ER0486	N	4000°K
	850 mm	0,25	48	3,8 W	ER0477	96	7,7 W	ER0482	192	15,4 W	ER0487	W	2700°K
	1150 mm	0,34	66	5,3 W	ER0478	132	10,6 W	ER0483	264	21,1 W	ER0488		

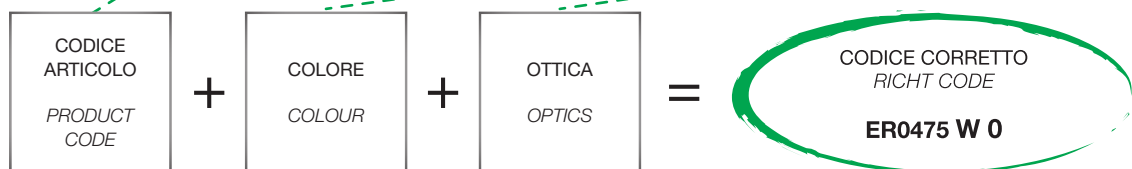



# SURFACE PROFILES

La linea SURFACE PROFILES è composta da profili lineari che possono soddisfare le più svariate esigenze di applicazione, suddivisi in barre con emissione simmetrica e barre con emissione asimmetrica. Le dimensioni ridotte garantiscono la massima versatilità e facilità nell'installazione a plafone, permettendo di aggiungere la luce ai mobili anche in un secondo momento. Le barre SURFACE PROFILES offrono un'illuminazione uniforme e sono disponibili nelle varianti basic, plus e top.

*The SURFACE PROFILES range consists of linear profiles that can meet the widest range of installation needs, subdivided into symmetric emission and asymmetric emission profiles. The reduced sizes guarantee maximum versatility and easy surface mounting, allowing you to add light to the furniture even at a later date. The SURFACE PROFILES provide uniform lighting and are available in the basic, plus and top versions.*





### Symmetric emission

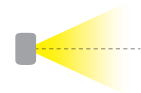

Lime page 10



Lord page 14

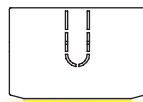

Slim page 18

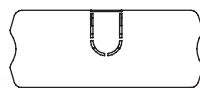

Vegan page 26

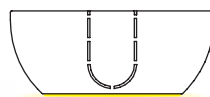

Lampas page 32

### Asymmetric emission

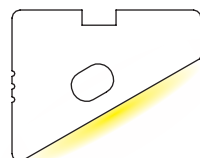
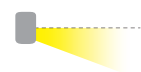

Cooper page 38

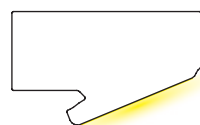

Mac page 42

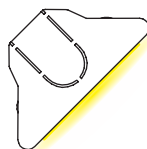

Kampas page 48

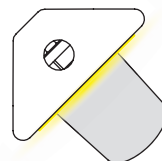

Nook page 54



Linul page 58





# Lime Info



## Descrizione *Description*

Profilo quadrato in policarbonato opale estruso, circuito ad alta densità con effetto di diffusione totale e uniforme. Installazione tramite staffa di fissaggio e viti autofilettanti incluse, facile connessione mediante cavo con attacco rapido.

*Squared profile made of extruded opal polycarbonate, rigid strip with high density diodes (90 LEDs/m), installation via fixing bracket and included self-tapping screws, easy connection using quick connectors.*

## Lunghezze disponibili *Available lengths*

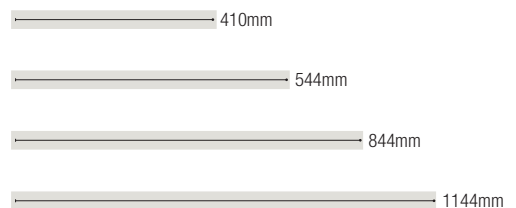

## Potenza LED disponibile *Available LED power*

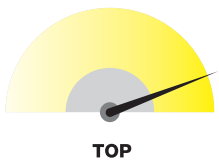

## Scala 1:1 *Scale 1:1*

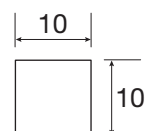



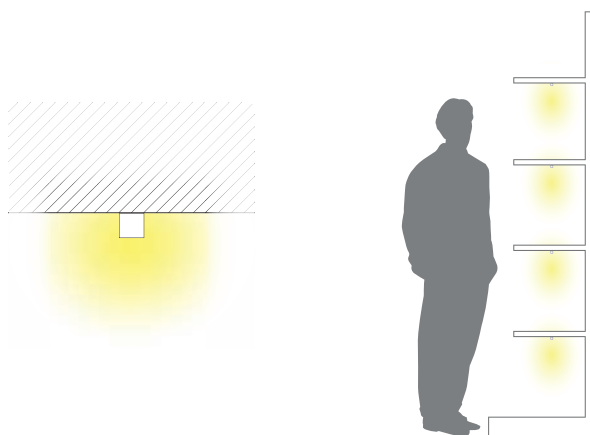

Sistemi di accensione  
Control system

STANDARD  
STANDARD

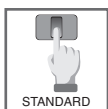

Accensione da prevedere con interruttore a parete o con sistemi remoti (pag 140-141)  
*Switching on and off should be provided via wall switch or with remote systems (page 140-141)*

SENSORE TOUCH  
TOUCH SENSOR



Accensione/spengimento tramite tocco su punto indicato da LED blu  
*Switching on/off is possible by touching the point indicated by the blue LED*

Applicazione  
Application

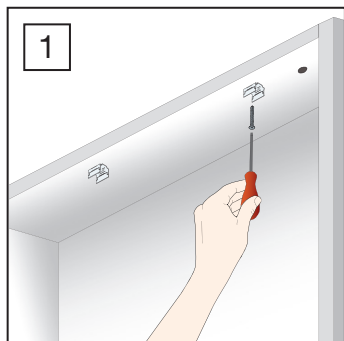

Avvitare sulla superficie desiderata le due staffe di fissaggio del profilo LIME.

*Screw the two LIME profile fixing brackets onto the desired surface.*

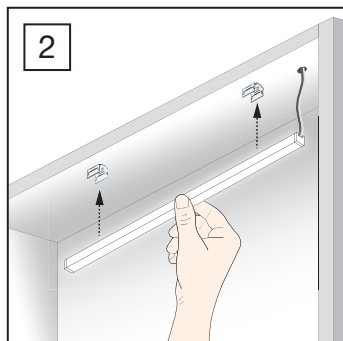

Agganciare alle due staffe il profilo LIME.

*Hook the LIME profile onto the two brackets.*

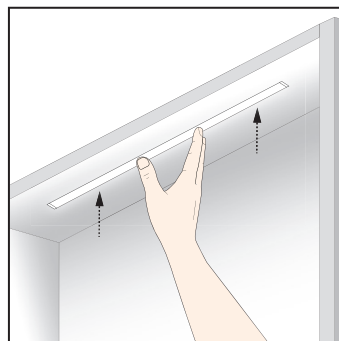

Il profilo LIME è applicabile anche ad incasso direttamente su apposita fresata nel legno.

*The LIME profile can also be installed recessed directly on a special groove in the wood.*

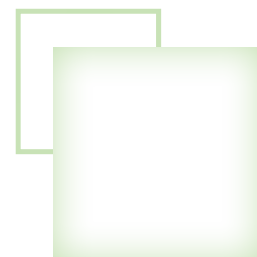

# Lime

versione standard  
standard version

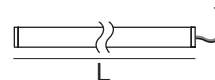

FINITURA FINISH		L.	kg	Lime TOP			COLORE COLOUR		OTTICA OPTICS
		→		LED's LED's	POTENZA POWER	CODICE CODE			
		410 mm	0,02	72	4,8 W	ER1044	C	5000°K	
Opaline		544 mm	0,03	96	6,4 W	ER1045	N	4000°K	
		844 mm	0,04	150	10 W	ER1046	W	3000°K	
		1144 mm	0,05	204	13,6 W	ER1047			

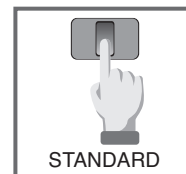

# Lime T

accensione e spegnimento tramite tocco su punto indicato dal LED blu  
switching on/off is possible by touching the point indicated by the blue LED

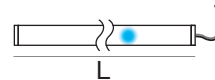

FINITURA FINISH		L.	kg	Lime T TOP			COLORE COLOUR		OTTICA OPTICS
		→		LED's LED's	POTENZA POWER	CODICE CODE			
		410 mm	0,02	60	4 W	ER1104	C	5000°K	
Opaline		544 mm	0,03	84	5,6 W	ER1106	N	4000°K	
		844 mm	0,04	138	9,2 W	ER1108	W	3000°K	
		1144 mm	0,05	192	12,8 W	ER1110			

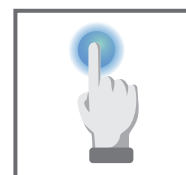







Descrizione  
*Description*

Profilo rettangolare in alluminio verniciato nero con opalino, circuito ad alta densità con effetto di luce diffusa e uniforme. Installazione tramite staffa di fissaggio e viti autofilettanti incluse, facile connessione mediante cavo con attacco rapido.

*Rectangular profile made of painted aluminium with opal, rigid strip with high density diodes, continuous, diffused light effect. Installation via fixing bracket and included self-tapping screws, easy connection using quick connectors.*

Lunghezze disponibili  
*Available lengths*

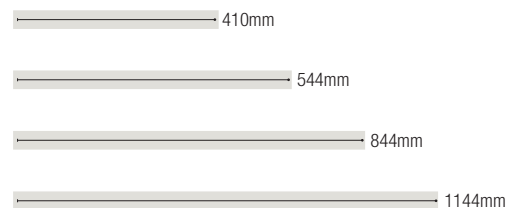

Potenze LED disponibili  
*Available LED powers*

Scala 1:1  
*Scale 1:1*

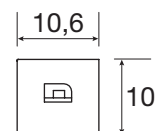
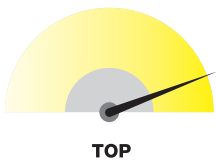

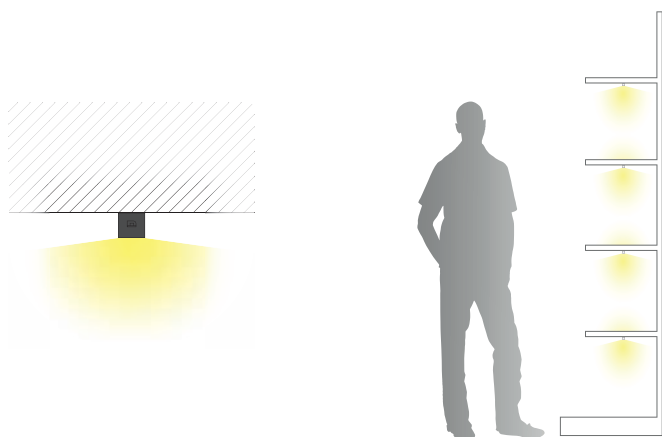

### Sistemi di accensione Control system

#### STANDARD STANDARD

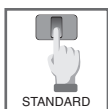

Accensione da prevedere con interruttore a parete o con sistemi remoti (pag 140-141)  
*Switching on and off should be provided via wall switch or with remote systems (page 140-141)*

#### SENSORE TOUCH TOUCH SENSOR



Accensione/spengimento tramite tocco su punto indicato da LED blu  
*Switching on/off is possible by touching the point indicated by the blue LED*

### Applicazione Application

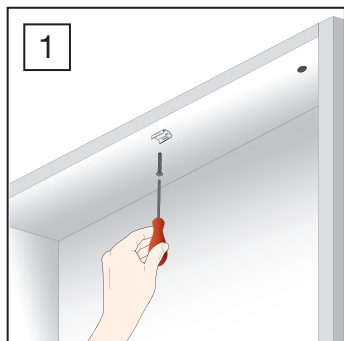

1  
Avvitare sulla superficie desiderata la staffa di fissaggio del profilo LORD.

*Screw the fastening bracket of the LORD profile on the desired surface.*

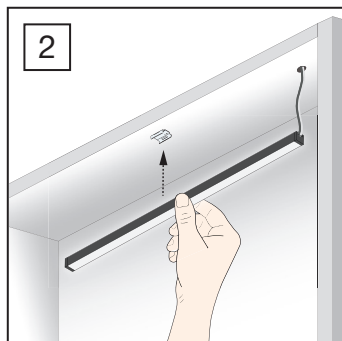

2  
Agganciare alla staffa il profilo LORD.

*Hook the LORD profile to the bracket.*

### Accessorio extra Extra accessory

Disponibile su richiesta copertura in policarbonato "Privacy", questa versione di copertura oscurata permette di mimmetizzare il profilo su arredamenti con finiture scure. Aspetto maggiormente percepibile quando il profilo è spento.

*"Privacy" polycarbonate cover is available on request. This darkened cover version allows you to camouflage the profile on furniture with a dark finish. The appearance is more noticeable when the profile is off.*



# Lord

versione standard  
standard version

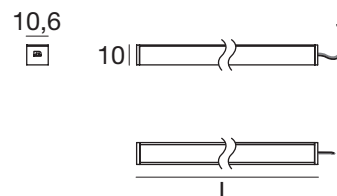

FINITURA FINISH	L. →	kg	LED's LED's	POTENZA POWER	CODICE CODE	COLORE COLOUR	OTTICA OPTICS
	410 mm	0,02	72	4,8 W	<b>ER1222</b>	<input type="checkbox"/> C 5000°K	
<b>Black</b>	544 mm	0,026	96	6,4 W	<b>ER1223</b>	<input type="checkbox"/> N 4000°K	<input type="checkbox"/> 0
	844 mm	0,041	150	10 W	<b>ER1224</b>	<input type="checkbox"/> W 3000°K	
	1144 mm	0,056	204	13,6 W	<b>ER1225</b>		

## Lord TOP

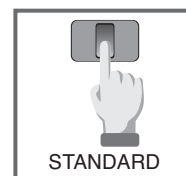

# Lord T

accensione e spegnimento tramite tocco su punto indicato dal LED blu  
switching on/off is possible by touching the point indicated by the blue LED

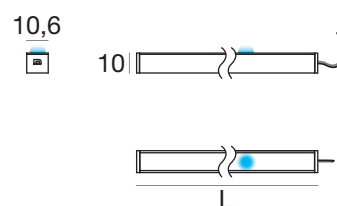

FINITURA FINISH	L. →	kg	LED's LED's	POTENZA POWER	CODICE CODE	COLORE COLOUR	OTTICA OPTICS
	410 mm	0,02	60	4 W	<b>ER1226</b>	<input type="checkbox"/> C 5000°K	
<b>Black</b>	544 mm	0,026	84	5,6 W	<b>ER1227</b>	<input type="checkbox"/> N 4000°K	<input type="checkbox"/> 0
	844 mm	0,041	138	9,2 W	<b>ER1228</b>	<input type="checkbox"/> W 3000°K	
	1144 mm	0,056	192	12,8 W	<b>ER1229</b>		

## Lord T TOP

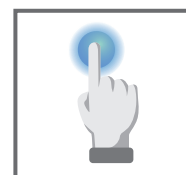

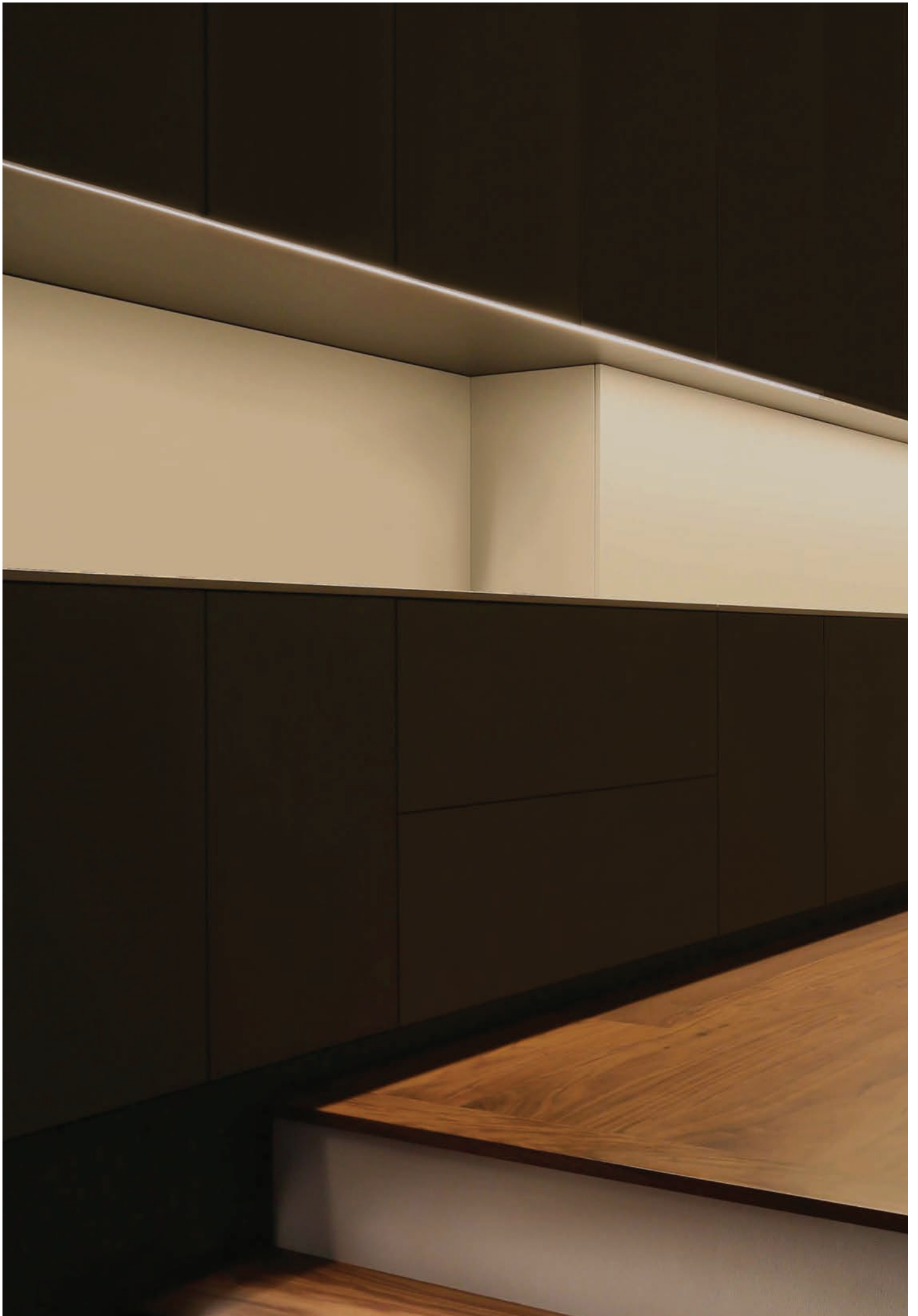





# Slim Info



## Descrizione *Description*

Profilo in alluminio estruso anodizzato dalle dimensioni ridotte. Installazione a plafone tramite viti autofilettanti completamente a scomparsa. Sorgente luminosa mono-emissione (30000 ore di durata) con diffusore opalino in policarbonato. Facile connessione elettrica.

*Anodized extruded aluminium profile with reduced size. Surface mounting using fully concealed self-tapping screws. Mono-emission light source (30000 hours duration) with opal polycarbonate diffuser. Easy electrical connection.*

## Lunghezze disponibili *Available lengths*

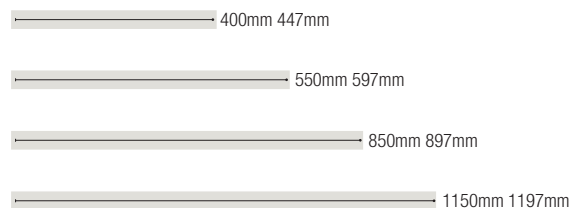

## Potenze LED disponibili *Available LED powers*

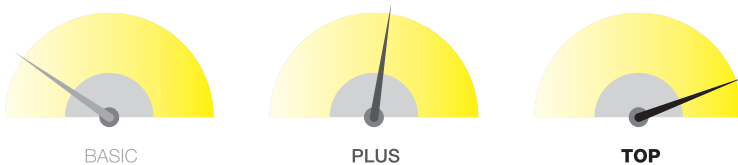

## Scala 1:1 *Scale 1:1*

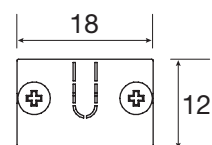



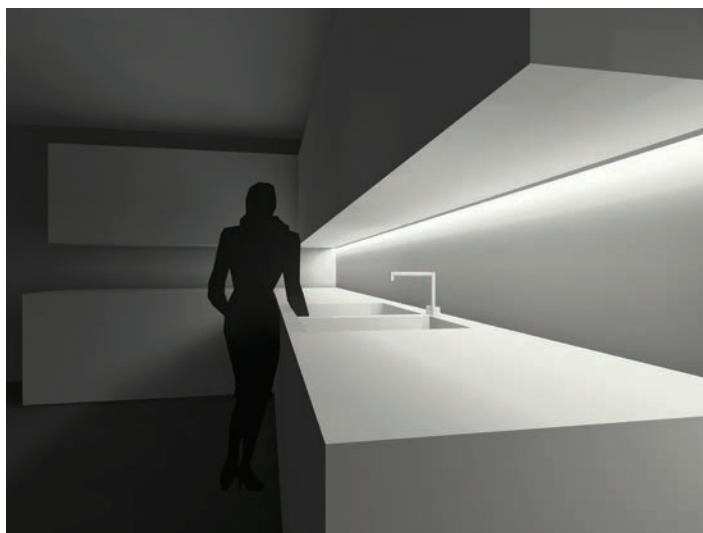
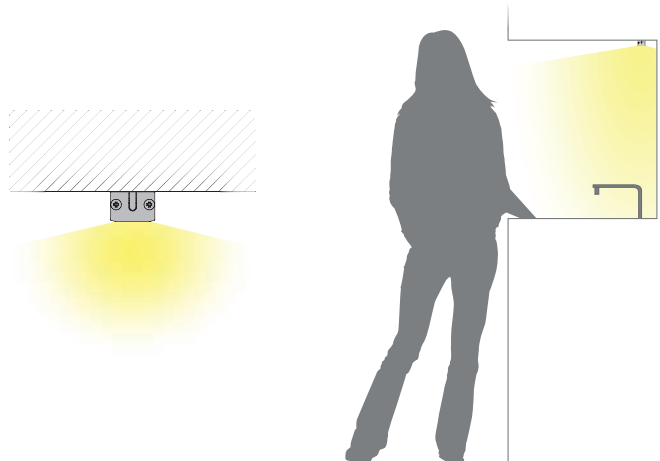

Sistemi di accensione  
Control system

STANDARD  
STANDARD

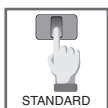

■

Accensione da prevedere con interruttore a parete o con sistemi remoti (pag 140-141)  
Switching on and off should be provided via wall switch or with remote systems (page 140-141)

INTERRUTTORE MECCANICO  
MECHANICAL SWITCH



B

Accensione/spengimento tramite interruttore meccanico incorporato  
Power on/off by means of an incorporated mechanical switch

SENSORE TOUCH  
TOUCH SENSOR



T

Accensione/spengimento tramite tocco su punto indicato da LED blu  
Switching on/off is possible by touching the point indicated by the blue LED

SENSORE TOUCH/DIMMER  
TOUCH/DIMMER SENSOR



TD

Accensione/spengimento e dimmerazione tramite tocco su punto indicato da LED blu  
Switching on/off and dimming is possible by touching the point indicated by the blue LED

SENSORE DI PROSSIMITÀ  
PROXIMITY SENSOR

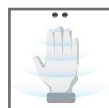

P

Sensore di prossimità, accensione e spegnimento tramite mano nei pressi del sensore  
Proximity sensor, switching on/off takes place passing a hand near the sensor

SENSORE PIR  
PIR SENSOR



S

Accensione tramite rilevamento, spegnimento automatico dopo 30" di mancato rilevamento  
Switching on by detection, switches off automatically after 30" seconds of no detection

SENSORE DI RIFLESSIONE  
REFLECTION SENSOR



R

Sensore di riflessione, accensione/spengimento tramite l'apertura o la chiusura di un'anta  
Reflection sensor, switching on/off by means of opening or closing a door

SENSORI DI RIFLESSIONE DOPPIO  
DOUBLE REFLECTION SENSOR

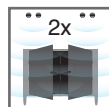

RR

Sensore di riflessione, accensione/spengimento tramite l'apertura o la chiusura di un'anta  
Reflection sensor, switching on/off by means of opening or closing a door

Applicazione  
Application

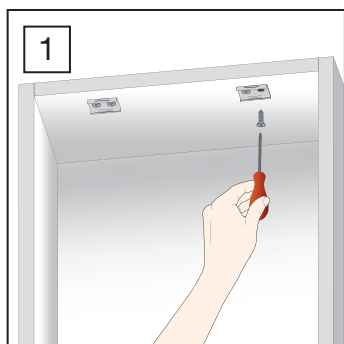

1 Avvitare sulla superficie desiderata le due staffe di fissaggio del profilo SLIM

Screw the two SLIM profile fixing brackets onto the desired surface

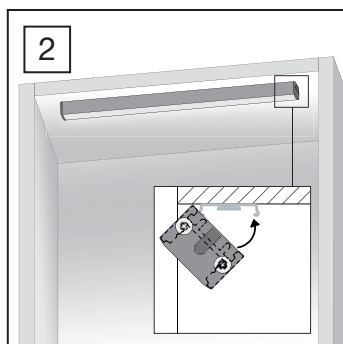

2 Agganciare alle due staffe il profilo SLIM

Hook the SLIM profile onto the two brackets



# Slim

versione standard  
standard version

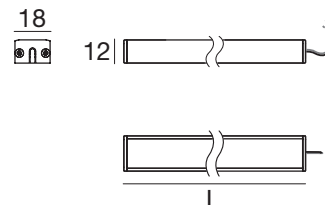

FINITURA FINISH	L. →	kg	Slim BASIC			Slim PLUS			Slim TOP		
			LED's LED's	POTENZA POWER	CODICE CODE	LED's LED's	POTENZA POWER	CODICE CODE	LED's LED's	POTENZA POWER	CODICE CODE
Anod. Al.	400 mm	0,13	18	1,4 W	<b>ER0475</b>	42	3,4 W	<b>ER0480</b>	84	6,7 W	<b>ER0485</b>
	550 mm	0,16	30	2,4 W	<b>ER0476</b>	60	4,8 W	<b>ER0481</b>	120	9,6 W	<b>ER0486</b>
	850 mm	0,25	48	3,8 W	<b>ER0477</b>	96	7,7 W	<b>ER0482</b>	192	15,4 W	<b>ER0487</b>
	1150 mm	0,34	66	5,3 W	<b>ER0478</b>	132	10,6 W	<b>ER0483</b>	264	21,1 W	<b>ER0488</b>

COLORE COLOUR	OTTICA OPTICS
<input type="checkbox"/> C 5000°K	<input type="checkbox"/> 0
<input type="checkbox"/> N 4000°K	
<input type="checkbox"/> W 2700°K	

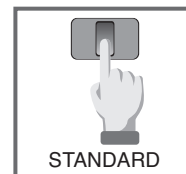

# Slim B

accensione/spengimento tramite interruttore meccanico  
power on/off by means of a mechanical switch

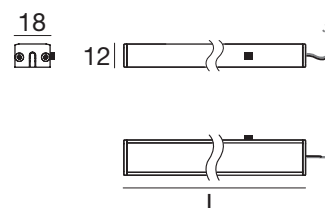

FINITURA FINISH	L. →	kg	Slim B BASIC			Slim B PLUS			Slim B TOP		
			LED's LED's	POTENZA POWER	CODICE CODE	LED's LED's	POTENZA POWER	CODICE CODE	LED's LED's	POTENZA POWER	CODICE CODE
Anod. Al.	447 mm	0,14	24	1,9 W	<b>ER0676</b>	48	3,8 W	<b>ER0681</b>	96	7,7 W	<b>ER0686</b>
	597 mm	0,17	30	2,4 W	<b>ER0677</b>	66	5,3 W	<b>ER0682</b>	132	10,6 W	<b>ER0687</b>
	897 mm	0,26	48	3,8 W	<b>ER0678</b>	102	8,2 W	<b>ER0683</b>	204	16,3 W	<b>ER0688</b>
	1197 mm	0,35	66	5,3 W	<b>ER0679</b>	138	11 W	<b>ER0684</b>	276	22,1 W	<b>ER0689</b>

COLORE COLOUR	OTTICA OPTICS
<input type="checkbox"/> C 5000°K	<input type="checkbox"/> 0
<input type="checkbox"/> N 4000°K	
<input type="checkbox"/> W 2700°K	



# Slim T

accensione e spegnimento tramite tocco su punto indicato dal LED blu  
switching on/off is possible by touching the point indicated by the blue LED

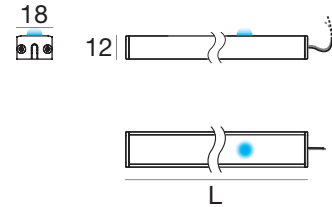

FINITURA FINISH	L. →	kg	Slim T BASIC			Slim T PLUS			Slim T TOP			COLORE COLOUR	OTTICA OPTICS
			LED's LED's	POTENZA POWER	CODICE CODE	LED's LED's	POTENZA POWER	CODICE CODE	LED's LED's	POTENZA POWER	CODICE CODE		
	447 mm	0,14	18	1,4 W	ER0618	42	3,4 W	ER0622	84	6,7 W	ER0626	<input type="checkbox"/> C 5000°K	<input type="checkbox"/> 0
Anod. Al.	597 mm	0,17	30	2,4 W	ER0619	60	4,8 W	ER0623	120	9,6 W	ER0627	<input type="checkbox"/> N 4000°K	
	897 mm	0,26	48	3,8 W	ER0620	96	7,7 W	ER0624	192	15,4 W	ER0628	<input type="checkbox"/> W 2700°K	
	1197 mm	0,35	66	5,3 W	ER0621	132	10,6 W	ER0625	264	21,1 W	ER0629		

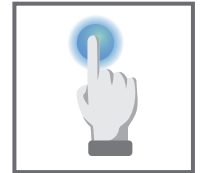

# Slim TD

accensione, spegnimento e dimmerazione (da 10% a 100%) tramite tocco su punto indicato dal LED blu  
switching on/off and dimming (from 10% to 100%) is possible by touching the point indicated by the blue LED

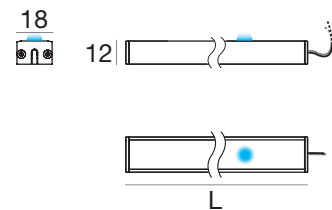

FINITURA FINISH	L. →	kg	Slim TD BASIC			Slim TD PLUS			Slim TD TOP			COLORE COLOUR	OTTICA OPTICS
			LED's LED's	POTENZA POWER	CODICE CODE	LED's LED's	POTENZA POWER	CODICE CODE	LED's LED's	POTENZA POWER	CODICE CODE		
	447 mm	0,14	18	1,4 W	ER1114	42	3,4 W	ER1118	84	6,7 W	ER1122	<input type="checkbox"/> C 5000°K	<input type="checkbox"/> 0
Anod. Al.	597 mm	0,17	30	2,4 W	ER1115	60	4,8 W	ER1119	120	9,6 W	ER1123	<input type="checkbox"/> N 4000°K	
	897 mm	0,26	48	3,8 W	ER1116	96	7,7 W	ER1120	192	15,4 W	ER1124	<input type="checkbox"/> W 2700°K	
	1197 mm	0,35	66	5,3 W	ER1117	132	10,6 W	ER1121	264	21,1 W	ER1125		

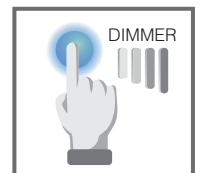

# Slim P

accensione e spegnimento tramite passaggio di una mano nei pressi del sensore (senza contatto)  
switching on and off by passing a hand near the sensor (without contact)

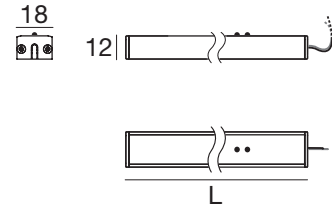

FINITURA FINISH	L. →	kg	Slim P BASIC			Slim P PLUS			Slim P TOP			COLORE COLOUR	OTTICA OPTICS
			LED's LED's	POTENZA POWER	CODICE CODE	LED's LED's	POTENZA POWER	CODICE CODE	LED's LED's	POTENZA POWER	CODICE CODE		
	447 mm	0,14	18	1,4 W	ER0594	42	3,4 W	ER0598	84	6,7 W	ER0602	<input type="checkbox"/> C 5000°K	<input type="checkbox"/> 0
Anod. Al.	597 mm	0,17	30	2,4 W	ER0595	60	4,8 W	ER0599	120	9,6 W	ER0603	<input type="checkbox"/> N 4000°K	
	897 mm	0,26	48	3,8 W	ER0596	96	7,7 W	ER0600	192	15,4 W	ER0604	<input type="checkbox"/> W 2700°K	
	1197 mm	0,35	66	5,3 W	ER0597	132	10,6 W	ER0601	264	21,1 W	ER0605		



# Slim S

accensione tramite sensore di presenza PIR, spegnimento automatico dopo 30"  
switching on by means of a PIR detector, switches off automatically after 30"

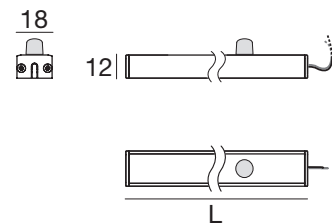

FINITURA FINISH	L. →	kg	Slim S BASIC			Slim S PLUS			Slim S TOP			COLORE COLOUR	OTTICA OPTICS
			LED's LED's	POTENZA POWER	CODICE CODE	LED's LED's	POTENZA POWER	CODICE CODE	LED's LED's	POTENZA POWER	CODICE CODE		
	400 mm	0,13	18	1,4 W	ER0501	36	2,9 W	ER0505	72	5,8 W	ER0509	<input type="checkbox"/> C 5000°K	<input type="checkbox"/> 0
Anod. Al.	550 mm	0,16	24	1,9 W	ER0502	54	4,3 W	ER0506	108	8,6 W	ER0510	<input type="checkbox"/> N 4000°K	
	850 mm	0,25	42	3,4 W	ER0503	90	7,2 W	ER0507	180	14,4 W	ER0511	<input type="checkbox"/> W 2700°K	
	1150 mm	0,34	60	4,8 W	ER0504	126	10,1 W	ER0508	252	20,2 W	ER0512		



# Slim R

accensione e spegnimento tramite rilevatore di apertura o chiusura di un'anta singola  
switching on and off is possible through the detection of opening or closing a single door

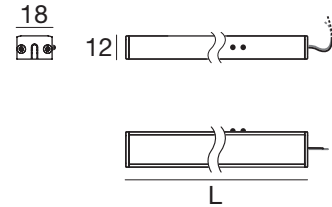

FINITURA FINISH		L.	kg	Slim R BASIC			Slim R PLUS			Slim R TOP			COLORE COLOUR	OTTICA OPTICS
		→		LED's LED's	POTENZA POWER	CODICE CODE	LED's LED's	POTENZA POWER	CODICE CODE	LED's LED's	POTENZA POWER	CODICE CODE		
		400 mm	0,13	18	1,4 W	<b>ER0690</b>	36	2,8 W	<b>ER0694</b>	72	5,8 W	<b>ER0698</b>	<input type="checkbox"/> C	<input type="checkbox"/> 0
Anod. Al.		550 mm	0,16	24	1,9 W	<b>ER0691</b>	54	4,3 W	<b>ER0695</b>	108	8,6 W	<b>ER0699</b>	<input type="checkbox"/> N	
		850 mm	0,25	42	3,4 W	<b>ER0692</b>	90	7,2 W	<b>ER0696</b>	180	14,4 W	<b>ER0700</b>	<input type="checkbox"/> W	
		1150 mm	0,34	60	4,8 W	<b>ER0693</b>	126	10,1 W	<b>ER0697</b>	252	20,2 W	<b>ER0701</b>	2700°K	

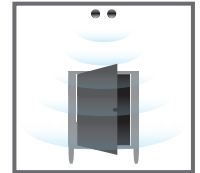

# Slim RR

accensione e spegnimento tramite doppio rilevatore di apertura o chiusura di un'anta doppia  
switching on and off is possible through the double detection of opening or closing a double door

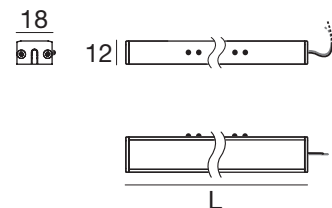
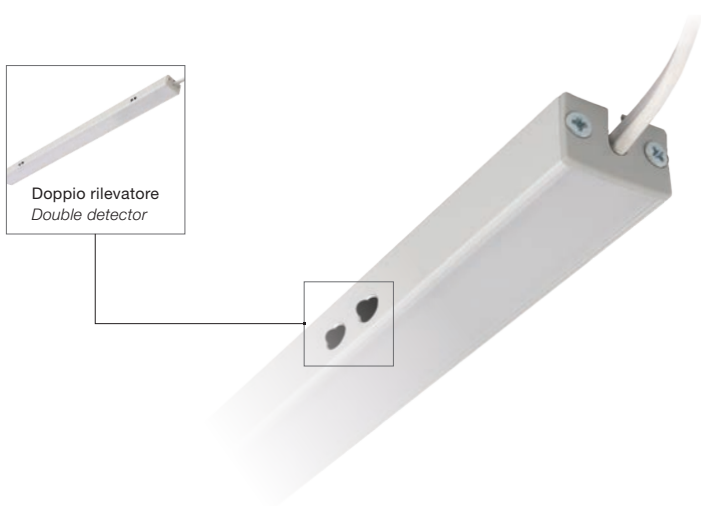

FINITURA FINISH		L.	kg	Slim RR BASIC			Slim RR PLUS			Slim RR TOP			COLORE COLOUR	OTTICA OPTICS
		→		LED's LED's	POTENZA POWER	CODICE CODE	LED's LED's	POTENZA POWER	CODICE CODE	LED's LED's	POTENZA POWER	CODICE CODE		
		850 mm	0,25	36	2,9 W	<b>ER0702</b>	78	6,2 W	<b>ER0704</b>	156	12,5 W	<b>ER0706</b>	<input type="checkbox"/> C	<input type="checkbox"/> 0
Anod. Al.		1150 mm	0,34	54	4,3 W	<b>ER0703</b>	114	9,1 W	<b>ER0705</b>	228	18,2 W	<b>ER0707</b>	<input type="checkbox"/> N	
													<input type="checkbox"/> W	

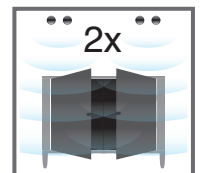

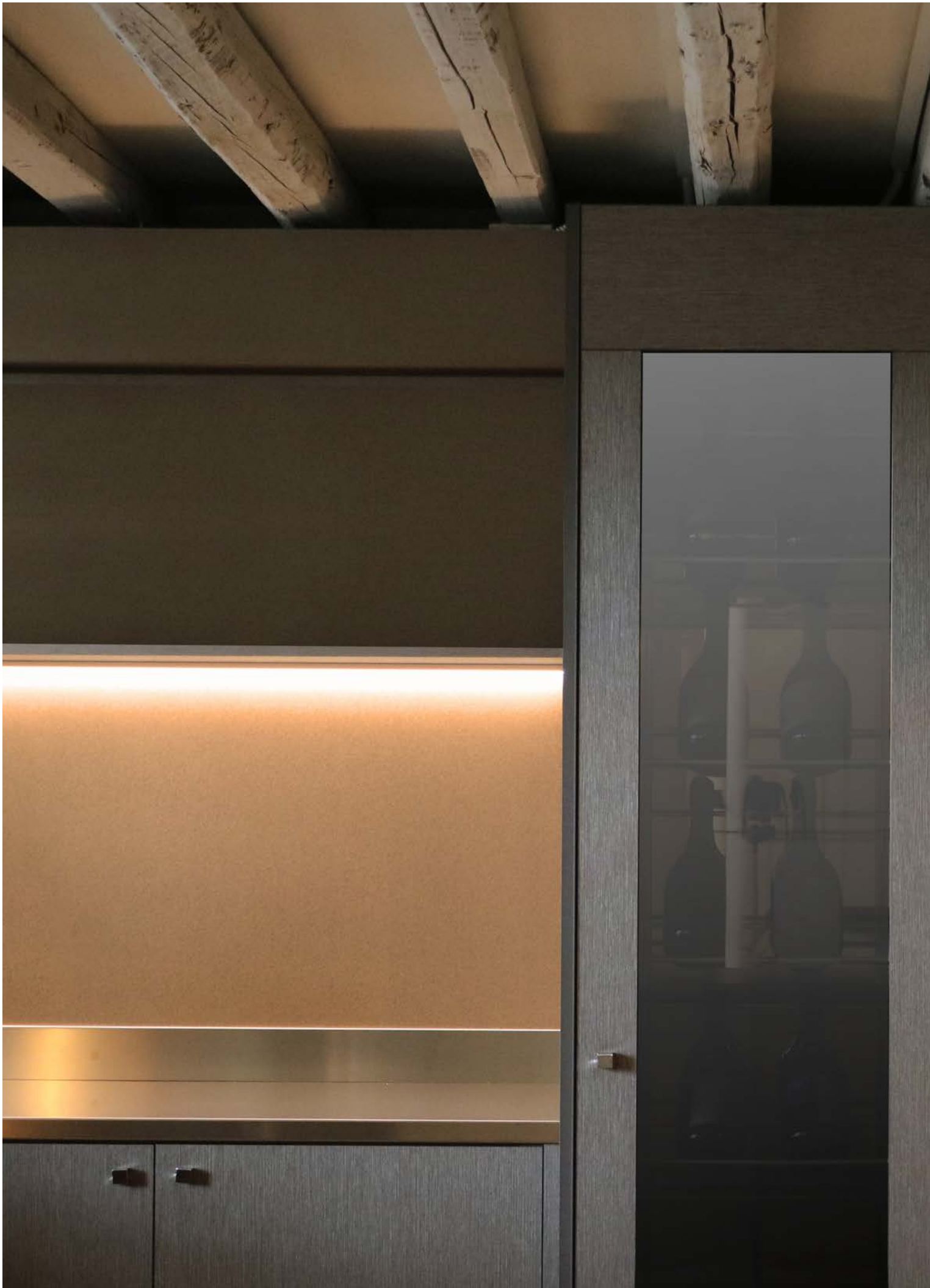



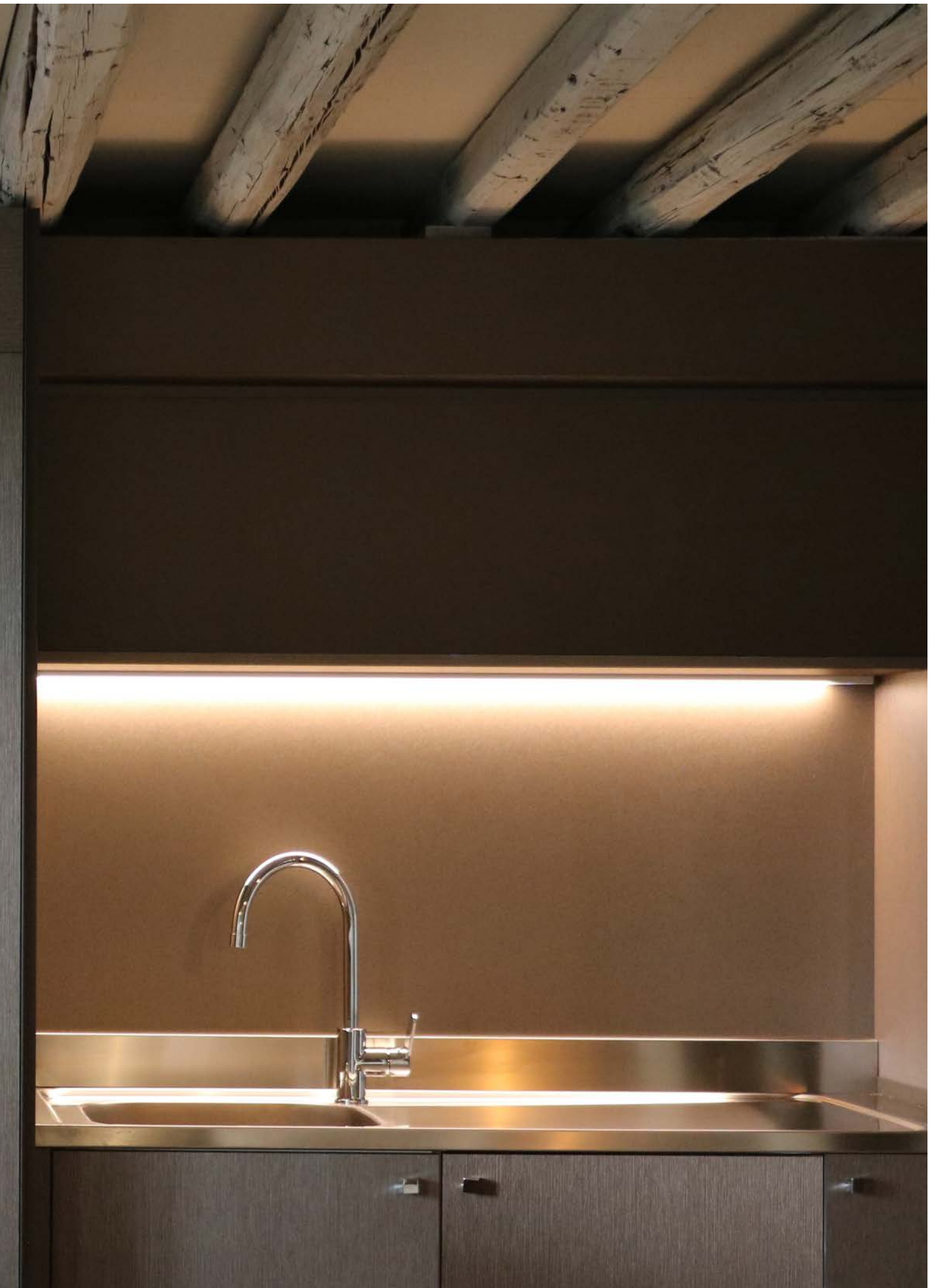



Descrizione  
*Description*

Profilo rettangolare sagomato in alluminio estruso anodizzato, copertura in polycarbonato opalino rigato. Installazione a plafone tramite viti autofilettanti. Dimensioni ridotte con facile connessione mediante cavo e attacco rapido

*Rectangular shaped profile made of extruded anodized aluminium, opal striped cover made of polycarbonate. Surface mounting using self-tapping screws. Reduced dimensions with easy connection using cable and quick connectors*

Lunghezze disponibili  
*Available lengths*

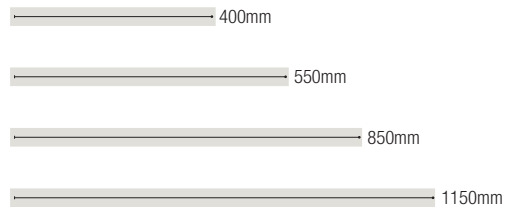

Potenze LED disponibili  
*Available LED powers*

Scala 1:1  
*Scale 1:1*

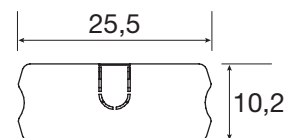
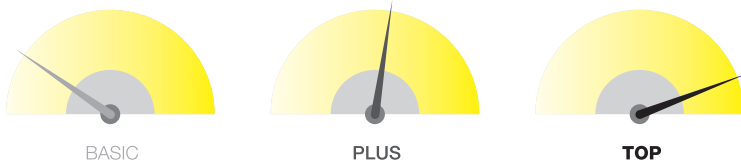



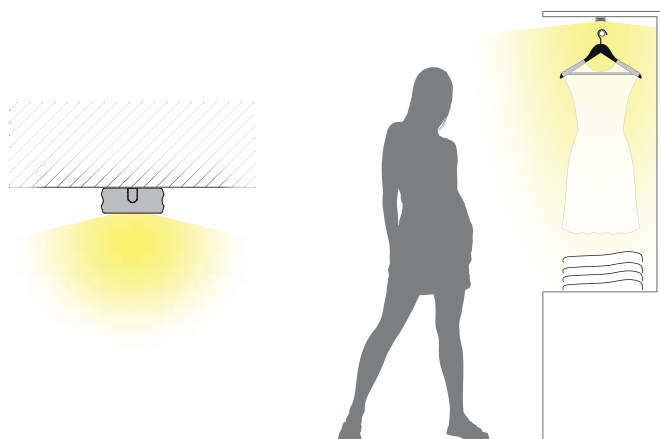

Sistemi di accensione  
Control system

STANDARD  
STANDARD

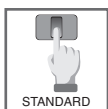

Accensione da prevedere con interruttore a parete o con sistemi remoti (pag 140-141)  
*Switching on and off should be provided via wall switch or with remote systems (page 140-141)*

SENSORE TOUCH  
TOUCH SENSOR



T

Accensione/spengimento tramite tocco su punto indicato da LED blu  
*Switching on/off is possible by touching the point indicated by the blue LED*

SENSORE TOUCH/DIMMER  
TOUCH/DIMMER SENSOR



TD

Accensione/spengimento e dimmerazione tramite tocco su punto indicato da LED blu  
*Switching on/off and dimming is possible by touching the point indicated by the blue LED*

SENSORE DI RIFLESSIONE  
REFLECTION SENSOR



R

Sensore di riflessione, accensione/spengimento tramite l'apertura o la chiusura di un'anta  
*Reflection sensor, switching on/off by means of opening or closing a door*

Applicazione  
Application

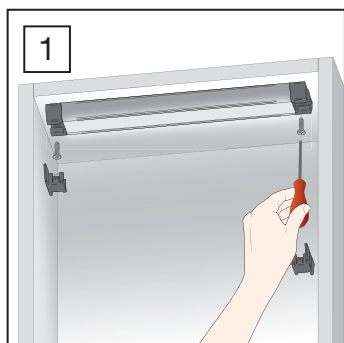

Le barre VEGAN con lunghezza 400mm e 550mm vengono fissate con viti direttamente sulla superficie.

*The 400mm and 550mm long VEGAN bars are secured with screws directly onto the surface.*

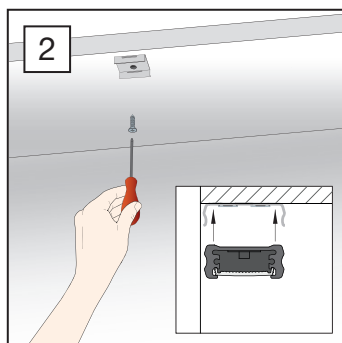

Le barre VEGAN con lunghezza 850mm e 1850mm necessitano di una molla di sostegno nel punto centrale del profilo.

*The 850mm and 1850mm long VEGAN bars require a support spring in the centre part of the profile.*

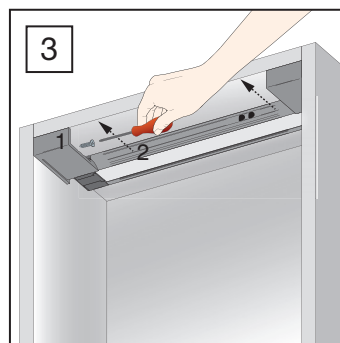

Le staffe di sostegno della variante VEGAN R vengono fissate lateralmente con viti.

*The VEGAN R version support brackets are secured laterally with screws.*



# Vegan

versione standard  
standard version



25,5

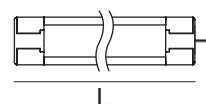

FINITURA FINISH	L.	kg
	400 mm	0,15
Anod. Al.	550 mm	0,19
	850 mm	0,27
	1150 mm	0,35

## Vegan BASIC

LED's LED's	POTENZA POWER	CODICE CODE
18	1,4 W	<b>ER0812</b>
30	2,4 W	<b>ER0813</b>
48	3,8 W	<b>ER0814</b>
66	5,3 W	<b>ER0815</b>

## Vegan PLUS

LED's LED's	POTENZA POWER	CODICE CODE
42	3,4 W	<b>ER0817</b>
60	4,8 W	<b>ER0818</b>
96	7,7 W	<b>ER0819</b>
132	10,6 W	<b>ER0820</b>

## Vegan TOP

LED's LED's	POTENZA POWER	CODICE CODE
84	6,7 W	<b>ER0822</b>
120	9,6 W	<b>ER0823</b>
192	15,4 W	<b>ER0824</b>
264	21,1 W	<b>ER0825</b>

COLORE COLOUR	OTTICA OPTICS
<input type="checkbox"/> C 5000°K	<input type="checkbox"/> 0
<input type="checkbox"/> N 4000°K	
<input type="checkbox"/> W 2700°K	

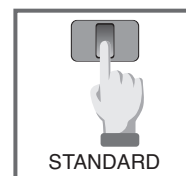

# Vegan T

accensione e spegnimento tramite tocco su punto indicato dal LED blu  
switching on/off is possible by touching the point indicated by the blue LED



25,5

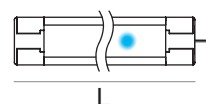

FINITURA FINISH	L.	kg
	447 mm	0,16
Anod. Al.	597 mm	0,22
	897 mm	0,30
	1197 mm	0,37

## Vegan T BASIC

LED's LED's	POTENZA POWER	CODICE CODE
18	1,4 W	<b>ER0838</b>
30	2,4 W	<b>ER0839</b>
48	3,8 W	<b>ER0840</b>
66	5,3 W	<b>ER0841</b>

## Vegan T PLUS

LED's LED's	POTENZA POWER	CODICE CODE
42	3,4 W	<b>ER0842</b>
60	4,8 W	<b>ER0843</b>
96	7,7 W	<b>ER0844</b>
132	10,6 W	<b>ER0845</b>

## Vegan T TOP

LED's LED's	POTENZA POWER	CODICE CODE
84	6,7 W	<b>ER0846</b>
120	9,6 W	<b>ER0847</b>
192	15,4 W	<b>ER0848</b>
264	21,1 W	<b>ER0849</b>

COLORE COLOUR	OTTICA OPTICS
<input type="checkbox"/> C 5000°K	<input type="checkbox"/> 0
<input type="checkbox"/> N 4000°K	
<input type="checkbox"/> W 2700°K	

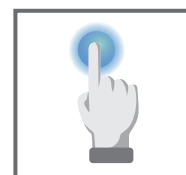

# Vegan TD

accensione, spegnimento e dimmerazione (da 10% a 100%) tramite tocco su punto indicato dal LED blu  
*switching on/off and dimming (from 10% to 100%) is possible by touching the point indicated by the blue LED*

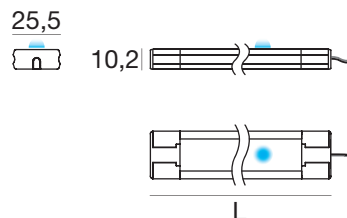

FINITURA FINISH	L.	kg
	447 mm	0,16
Anod. Al.	597 mm	0,22
	897 mm	0,30
	1197 mm	0,37

## Vegan TD BASIC

LED's LED's	POTENZA POWER	CODICE CODE
18	1,4 W	<b>ER1126</b>
30	2,4 W	<b>ER1127</b>
48	3,8 W	<b>ER1128</b>
66	5,3 W	<b>ER1129</b>

## Vegan TD PLUS

LED's LED's	POTENZA POWER	CODICE CODE
42	3,4 W	<b>ER1130</b>
60	4,8 W	<b>ER1131</b>
96	7,7 W	<b>ER1132</b>
132	10,6 W	<b>ER1133</b>

## Vegan TD TOP

LED's LED's	POTENZA POWER	CODICE CODE
84	6,7 W	<b>ER1134</b>
120	9,6 W	<b>ER1135</b>
192	15,4 W	<b>ER1136</b>
264	21,1 W	<b>ER1137</b>

COLORE COLOUR	OTTICA OPTICS
<input type="checkbox"/> C 5000°K	<input type="checkbox"/> 0
<input type="checkbox"/> N 4000°K	
<input type="checkbox"/> W 2700°K	

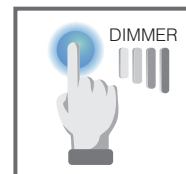

# Vegan R

accensione e spegnimento tramite rilevatore di apertura o chiusura di un'anta singola  
*switching on and off is possible through the detection of opening or closing a single door*

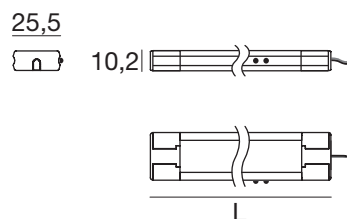

FINITURA FINISH	L.	kg
	407 mm	0,16
Anod. Al.	557 mm	0,22
	857 mm	0,30
	1157 mm	0,37

## Vegan R BASIC

LED's LED's	POTENZA POWER	CODICE CODE
18	1,4 W	<b>ER1092</b>
24	1,9 W	<b>ER1093</b>
42	3,4 W	<b>ER1094</b>
60	4,8 W	<b>ER1095</b>

## Vegan R PLUS

LED's LED's	POTENZA POWER	CODICE CODE
36	2,9 W	<b>ER1096</b>
54	4,3 W	<b>ER1097</b>
90	7,2 W	<b>ER1098</b>
126	10,1 W	<b>ER1099</b>

## Vegan R TOP

LED's LED's	POTENZA POWER	CODICE CODE
72	5,8	<b>ER1100</b>
108	8,4	<b>ER1101</b>
180	14,4	<b>ER1102</b>
252	20,2	<b>ER1103</b>

COLORE COLOUR	OTTICA OPTICS
<input type="checkbox"/> C 5000°K	<input type="checkbox"/> 0
<input type="checkbox"/> N 4000°K	
<input type="checkbox"/> W 2700°K	

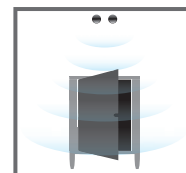









# Lampas Info



## Descrizione Description

**Profilo rettangolare arrotondato in alluminio estruso anodizzato, installazione pratica e veloce. Schermo in policarbonato opalino, 30.000 ore di durata. Facile connessione mediante cavo con attacco rapido**

*Rectangular rounded anodized profile in extruded aluminium, practical and quick installation. Opal polycarbonate screen, 30,000 hours life. Easy electrical connection using cable with quick connector*

## Lunghezze disponibili Available lengths

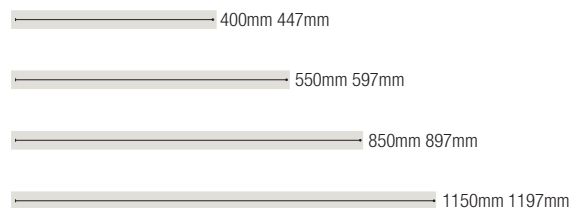

## Potenze LED disponibili Available LED powers

## Scala 1:1 Scale 1:1

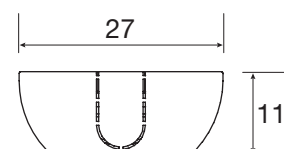
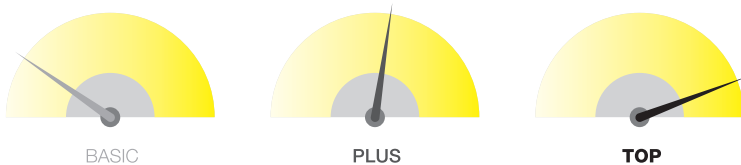

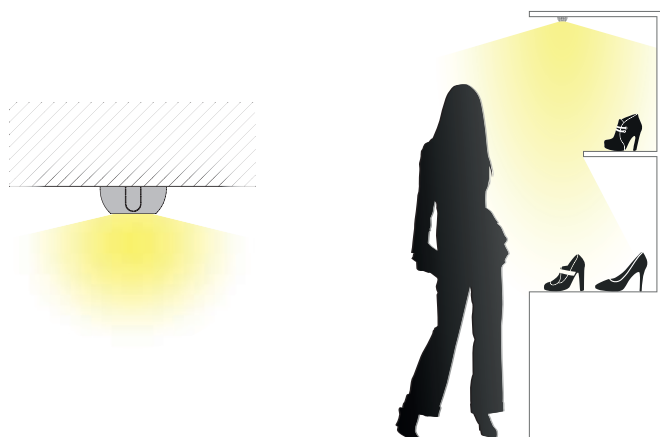

Sistemi di accensione  
Control system

STANDARD  
STANDARD

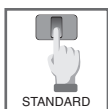

Accensione da prevedere con interruttore a parete o con sistemi remoti (pag 140-141)  
*Switching on and off should be provided via wall switch or with remote systems (page 140-141)*

SENSORE TOUCH  
TOUCH SENSOR



Accensione/spengimento tramite tocco su punto indicato da LED blu.  
*Switching on/off is possible by touching the point indicated by the blue LED.*

SENSORE TOUCH/DIMMER  
TOUCH/DIMMER SENSOR



Accensione/spengimento e dimmerazione tramite tocco su punto indicato da LED blu.  
*Switching on/off and dimming is possible by touching the point indicated by the blue LED.*

Applicazione  
Application

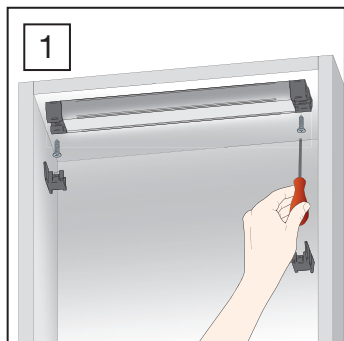

Le barre LAMPAS con lunghezza 400mm e 550mm vengono fissate con viti direttamente sulla superficie.

*The 400mm and 550mm long LAMPAS bars are secured with screws directly onto the surface.*

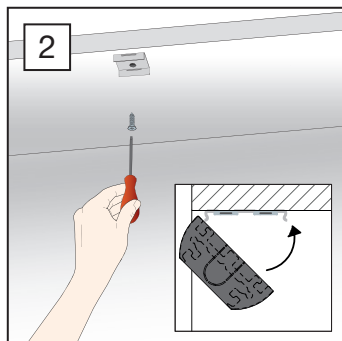

Le barre LAMPAS con lunghezza 850mm e 1850mm necessitano di una molla di sostegno nel punto centrale del profilo.

*The 850mm and 1850mm long LAMPAS bars require a support spring in the centre part of the profile.*



# Lampas

versione standard  
standard version

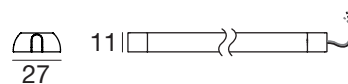

FINITURA FINISH	L. →	kg
	400 mm	0,15
Anod. Al.	550 mm	0,21
	850 mm	0,32
	1150 mm	0,42

## Lampas BASIC

LED's LED's	POTENZA POWER	CODICE CODE
18	1,4 W	<b>ER0182</b>
30	2,4 W	<b>ER0183</b>
48	3,8 W	<b>ER0184</b>
66	5,3 W	<b>ER0185</b>

## Lampas PLUS

LED's LED's	POTENZA POWER	CODICE CODE
42	3,4 W	<b>ER0375</b>
60	4,8 W	<b>ER0376</b>
96	7,7 W	<b>ER0377</b>
132	10,6 W	<b>ER0378</b>

## Lampas TOP

LED's LED's	POTENZA POWER	CODICE CODE
84	6,7 W	<b>ER0192</b>
120	9,6 W	<b>ER0193</b>
192	15,4 W	<b>ER0194</b>
264	21,1 W	<b>ER0195</b>

COLORE COLOUR	OTTICA OPTICS
<input type="checkbox"/> C 5000°K	<input type="checkbox"/> 0
<input type="checkbox"/> N 4000°K	
<input type="checkbox"/> W 2700°K	

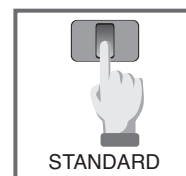

# Lampas T

accensione e spegnimento tramite tocco su punto indicato dal LED blu  
switching on/off is possible by touching the point indicated by the blue LED

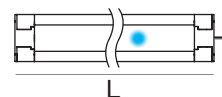
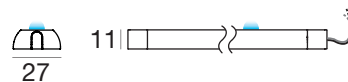

FINITURA FINISH	L. →	kg
	447 mm	0,16
Anod. Al.	597 mm	0,22
	897 mm	0,34
	1197 mm	0,44

## Lampas T BASIC

LED's LED's	POTENZA POWER	CODICE CODE
18	1,4 W	<b>ER0708</b>
30	2,4 W	<b>ER0709</b>
48	3,8 W	<b>ER0710</b>
66	5,3 W	<b>ER0711</b>

## Lampas T PLUS

LED's LED's	POTENZA POWER	CODICE CODE
42	3,4 W	<b>ER0712</b>
60	4,8 W	<b>ER0713</b>
96	7,7 W	<b>ER0714</b>
132	10,6 W	<b>ER0715</b>

## Lampas T TOP

LED's LED's	POTENZA POWER	CODICE CODE
84	6,7 W	<b>ER0716</b>
120	9,6 W	<b>ER0717</b>
192	15,4 W	<b>ER0718</b>
264	21,1 W	<b>ER0719</b>

COLORE COLOUR	OTTICA OPTICS
<input type="checkbox"/> C 5000°K	<input type="checkbox"/> 0
<input type="checkbox"/> N 4000°K	
<input type="checkbox"/> W 2700°K	





# Lampas TD

accensione, spegnimento e dimmerazione (da 10% a 100%) tramite tocco su punto indicato dal LED blu  
 switching on/off and dimming (from 10% to 100%) is possible by touching the point indicated by the blue LED

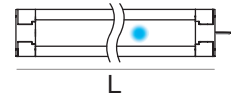
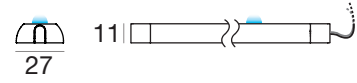

FINITURA FINISH	L. →	kg
	447 mm	0,16
Anod. Al.	597 mm	0,22
	897 mm	0,34
	1197 mm	0,44

Lampas TD BASIC		
LED's LED's	POTENZA POWER	CODICE CODE
18	1,4 W	ER1138
30	2,4 W	ER1139
48	3,8 W	ER1140
66	5,3 W	ER1141

Lampas TD PLUS		
LED's LED's	POTENZA POWER	CODICE CODE
42	3,4 W	ER1142
60	4,8 W	ER1143
96	7,7 W	ER1144
132	10,6 W	ER1145

Lampas TD TOP		
LED's LED's	POTENZA POWER	CODICE CODE
84	6,7 W	ER1146
120	9,6 W	ER1147
192	15,4 W	ER1148
264	21,1 W	ER1149

COLORE COLOUR	OTTICA OPTICS
<input type="checkbox"/> C 5000°K	<input type="checkbox"/> 0
<input type="checkbox"/> N 4000°K	
<input type="checkbox"/> W 2700°K	











## Descrizione *Description*

Profilo angolare in alluminio estruso anodizzato, installazione a plafone tramite clip a scomparsa adatta per punti angolari in orizzontale o verticale. Schermo in policarbonato opalino, facile connessione mediante cavo con attacco rapido.

*Corner profile made of anodized extruded aluminium, ceiling installation with retractable clip, suitable for horizontal or vertical corner points. Opal polycarbonate screen, easy electrical connection using cable with quick connector.*

## Lunghezze disponibili *Available lengths*

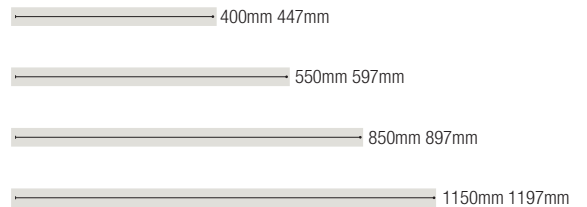

## Potenze LED disponibili *Available LED powers*

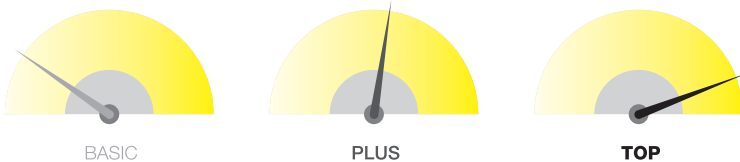

## Scala 1:1 *Scale 1:1*

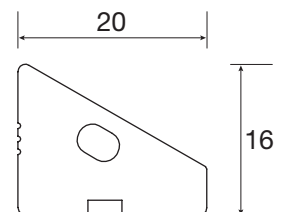

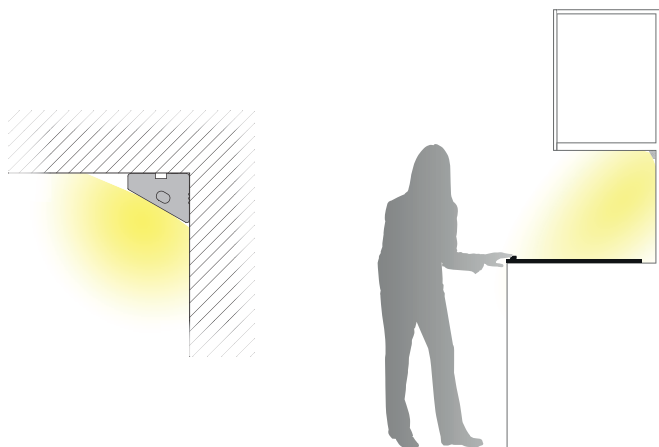

Sistemi di accensione  
Control system

STANDARD  
STANDARD

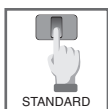

Accensione da prevedere con interruttore a parete o con sistemi remoti (pag 140-141)  
*Switching on and off should be provided via wall switch or with remote systems (page 140-141)*

SENSORE TOUCH  
TOUCH SENSOR



Accensione/spegnimento tramite tocco su punto indicato da LED blu.  
*Switching on/off is possible by touching the point indicated by the blue LED.*

SENSORE TOUCH/DIMMER  
TOUCH/DIMMER SENSOR



Accensione/spegnimento e dimmerazione tramite tocco su punto indicato da LED blu.  
*Switching on/off and dimming is possible by touching the point indicated by the blue LED.*

Applicazione  
Application

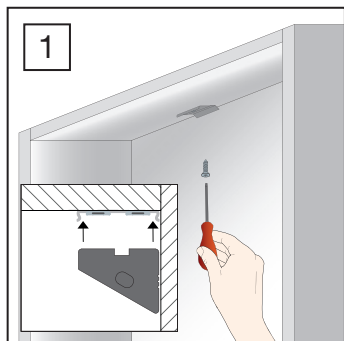

La staffa di fissaggio per profilo COOPER viene fissata alla superficie desiderata tramite vite.  
*The COOPER fixing bracket is secured to the desired surface using screws.*

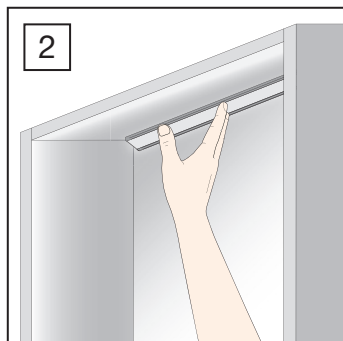

Agganciare alla/e staffa/e il profilo COOPER.  
*Hook the COOPER profile onto the bracket.*

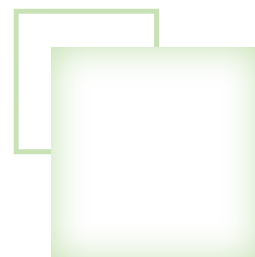

# Cooper

versione standard  
standard version

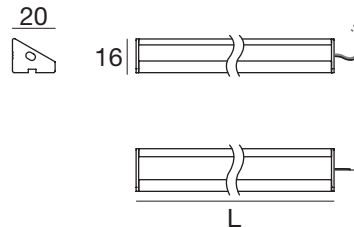

FINITURA FINISH			L.			kg		
			400 mm			0,13		
Anod. Al.			550 mm			0,16		
			850 mm			0,25		
			1150 mm			0,34		

Cooper BASIC			Cooper PLUS			Cooper TOP		
LED's LED's	POTENZA POWER	CODICE CODE	LED's LED's	POTENZA POWER	CODICE CODE	LED's LED's	POTENZA POWER	CODICE CODE
18	1,4 W	ER1230	42	3,3 W	ER1234	84	6,7 W	ER1238
30	2,4 W	ER1231	60	4,8 W	ER1235	120	9,6 W	ER1239
48	3,8 W	ER1232	96	7,7 W	ER1236	192	15,3 W	ER1240
66	5,3 W	ER1233	132	10,6 W	ER1237	264	21,1 W	ER1241

  

COLORE COLOUR	OTTICA OPTICS
<input type="checkbox"/> C 5000°K	<input type="checkbox"/> 0
<input type="checkbox"/> N 4000°K	
<input type="checkbox"/> W 2700°K	

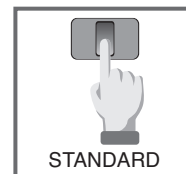

# Cooper T

accensione e spegnimento tramite tocco su punto indicato dal LED blu  
switching on/off is possible by touching the point indicated by the blue LED

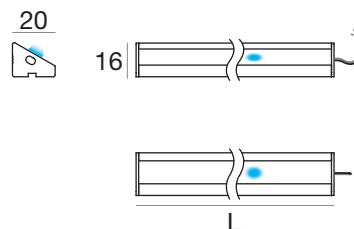

FINITURA FINISH			L.			kg		
			447 mm			0,14		
Anod. Al.			597 mm			0,17		
			897 mm			0,26		
			1197 mm			0,35		

Cooper T BASIC			Cooper T PLUS			Cooper T TOP		
LED's LED's	POTENZA POWER	CODICE CODE	LED's LED's	POTENZA POWER	CODICE CODE	LED's LED's	POTENZA POWER	CODICE CODE
18	1,4 W	ER1242	42	3,3 W	ER1246	84	6,7 W	ER1250
30	2,4 W	ER1243	60	4,8 W	ER1247	120	9,6 W	ER1251
48	3,8 W	ER1244	96	7,7 W	ER1248	192	15,3 W	ER1252
66	5,3 W	ER1245	132	10,6 W	ER1249	264	21,1 W	ER1253

COLORE COLOUR	OTTICA OPTICS
<input type="checkbox"/> C 5000°K	<input type="checkbox"/> 0
<input type="checkbox"/> N 4000°K	
<input type="checkbox"/> W 2700°K	





# Cooper TD

accensione, spegnimento e dimmerazione (da 10% a 100%) tramite tocco su punto indicato dal LED blu  
 switching on/off and dimming (from 10% to 100%) is possible by touching the point indicated by the blue LED

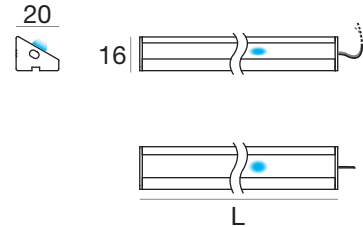

FINITURA FINISH	L. →	kg	Cooper TD BASIC			Cooper TD PLUS			Cooper TD TOP			COLORE COLOUR	OTTICA OPTICS
			LED's LED's	POTENZA POWER	CODICE CODE	LED's LED's	POTENZA POWER	CODICE CODE	LED's LED's	POTENZA POWER	CODICE CODE		
	447 mm	0,14	18	1,4 W	ER1254	42	3,3 W	ER1258	84	6,7 W	ER1262	<input type="checkbox"/> C 5000°K	<input type="checkbox"/> 0
Anod. AL	597 mm	0,17	30	2,4 W	ER1255	60	4,8 W	ER1259	120	9,6 W	ER1263	<input type="checkbox"/> N 4000°K	
	897 mm	0,26	48	3,8 W	ER1256	96	7,7 W	ER1260	192	15,3 W	ER1264	<input type="checkbox"/> W 2700°K	
	1197 mm	0,35	66	5,3 W	ER1257	132	10,6 W	ER1261	264	21,1 W	ER1265		

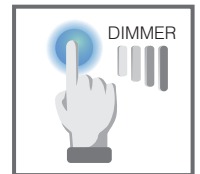



# Mac Info



## Descrizione *Description*

Profilo asimmetrico in alluminio estruso anodizzato, copertura in policarbonato opalino, installazione a ridosso tramite staffa e viti autofilettanti completamente a scomparsa, facile connessione mediante cavo con attacco rapido, luce direzionata ideale per ripiani e scaffalature.

*Asymmetric profile made of anodized extruded aluminium, opal cover made of polycarbonate, surface mounting using brackets and fully concealed self-tapping screws, easy connection using cable with quick connectors, directed light ideal for shelves and counters.*

## Lunghezze disponibili *Available lengths*

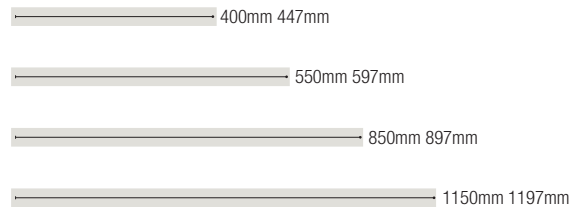

## Potenze LED disponibili *Available LED powers*

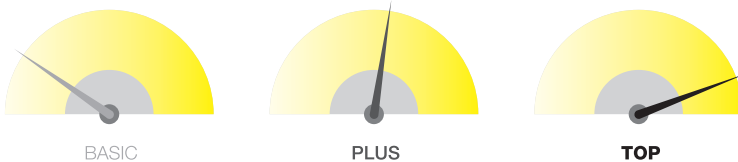

## Scala 1:1 *Scale 1:1*

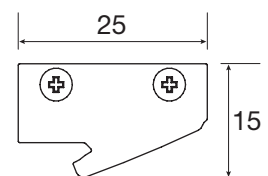

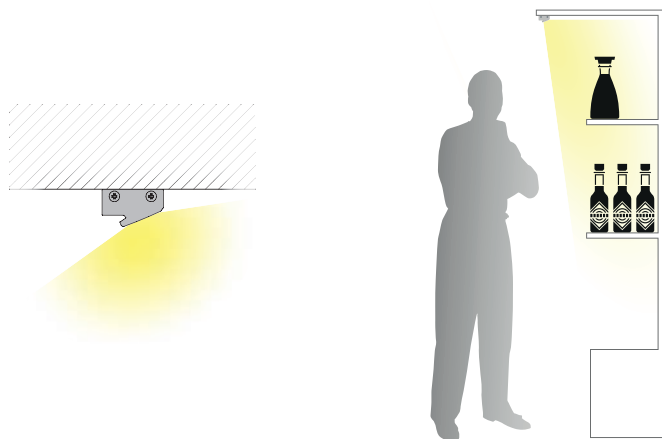

Sistemi di accensione  
Control system

STANDARD  
STANDARD

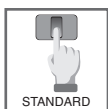

Accensione da prevedere con interruttore a parete o con sistemi remoti (pag 140-141)  
*Switching on and off should be provided via wall switch or with remote systems (page 140-141)*

SENSORE TOUCH  
TOUCH SENSOR



Accensione/spengimento tramite tocco su punto indicato da LED blu.  
*Switching on/off is possible by touching the point indicated by the blue LED.*

SENSORE TOUCH/DIMMER  
TOUCH/DIMMER SENSOR



Accensione/spengimento e dimmerazione tramite tocco su punto indicato da LED blu.  
*Switching on/off and dimming is possible by touching the point indicated by the blue LED.*

Applicazione  
Application

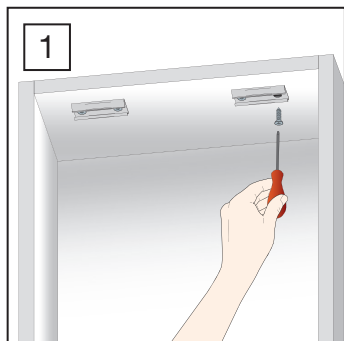

Avvitare sulla superficie desiderata le due staffe di fissaggio del profilo MAC.

*Screw the two MAC profile fixing brackets onto the desired surface.*

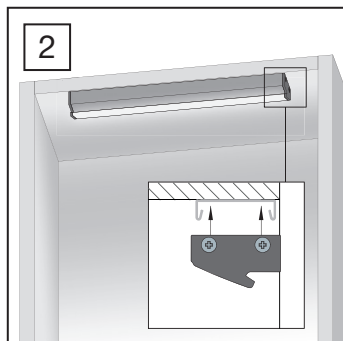

Agganciare alle due staffe il profilo MAC.

*Hook the MAC profile onto the two brackets.*

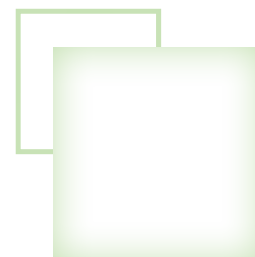

# Mac

versione standard  
standard version

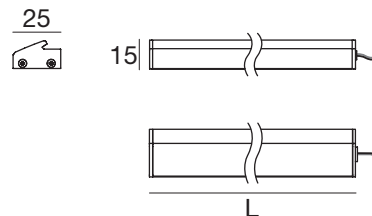

FINITURA FINISH	L. →	kg	Mac BASIC			Mac PLUS			Mac TOP			COLORE COLOUR	OTTICA OPTICS
			LED's LED's	POTENZA POWER	CODICE CODE	LED's LED's	POTENZA POWER	CODICE CODE	LED's LED's	POTENZA POWER	CODICE CODE		
Anod. Al.	400 mm	0,19	18	1,4 W	ER1020	42	3,4 W	ER1024	84	6,7 W	ER1028	<input type="checkbox"/> C 5000°K <input type="checkbox"/> N 4000°K <input type="checkbox"/> W 2700°K	<input checked="" type="checkbox"/> 0
	550 mm	0,25	30	2,4 W	ER1021	60	4,8 W	ER1025	120	9,6 W	ER1029		
	850 mm	0,40	48	3,8 W	ER1022	96	7,7 W	ER1026	192	15,4 W	ER1030		
	1150 mm	0,53	66	5,3 W	ER1023	132	10,6 W	ER1027	264	21,1 W	ER1031		

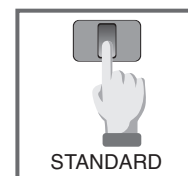

# Mac T

accensione e spegnimento tramite tocco su punto indicato dal LED blu  
switching on/off is possible by touching the point indicated by the blue LED

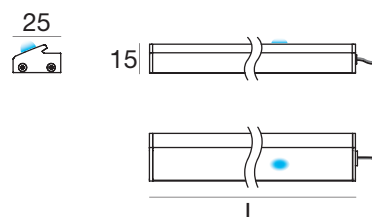

FINITURA FINISH	L. →	kg	Mac T BASIC			Mac T PLUS			Mac T TOP			COLORE COLOUR	OTTICA OPTICS
			LED's LED's	POTENZA POWER	CODICE CODE	LED's LED's	POTENZA POWER	CODICE CODE	LED's LED's	POTENZA POWER	CODICE CODE		
Anod. Al.	447 mm	0,19	18	1,4 W	ER1032	42	3,4 W	ER1036	84	6,7 W	ER1040	<input type="checkbox"/> C 5000°K <input type="checkbox"/> N 4000°K <input type="checkbox"/> W 2700°K	<input checked="" type="checkbox"/> 0
	597 mm	0,25	30	2,4 W	ER1033	60	4,8 W	ER1037	120	9,6 W	ER1041		
	897 mm	0,40	48	3,8 W	ER1034	96	7,7 W	ER1038	192	15,4 W	ER1042		
	1197 mm	0,53	66	5,3 W	ER1035	132	10,6 W	ER1039	264	21,1 W	ER1043		

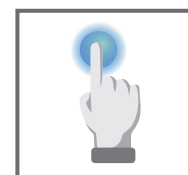



# Mac TD

accensione, spegnimento e dimmerazione (da 10% a 100%) tramite tocco su punto indicato dal LED blu  
*switching on/off and dimming (from 10% to 100%) is possible by touching the point indicated by the blue LED*

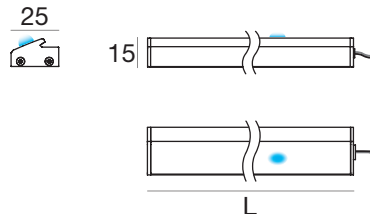

FINITURA FINISH	L. →	kg
	447 mm	0,19
Anod. Al.	597 mm	0,25
	897 mm	0,40
	1197 mm	0,53

## Mac TD BASIC

LED's LED's	POTENZA POWER	CODICE CODE
18	1,4 W	<b>ER1150</b>
30	2,4 W	<b>ER1151</b>
48	3,8 W	<b>ER1152</b>
66	5,3 W	<b>ER1153</b>

## Mac TD PLUS

LED's LED's	POTENZA POWER	CODICE CODE
42	3,4 W	<b>ER1154</b>
60	4,8 W	<b>ER1155</b>
96	7,7 W	<b>ER1156</b>
132	10,6 W	<b>ER1157</b>

## Mac TD TOP

LED's LED's	POTENZA POWER	CODICE CODE
84	6,7 W	<b>ER1158</b>
120	9,6 W	<b>ER1159</b>
192	15,4 W	<b>ER1160</b>
264	21,1 W	<b>ER1161</b>

COLORE COLOUR	OTTICA OPTICS
<input type="checkbox"/> C 5000°K	<input type="checkbox"/> 0
<input type="checkbox"/> N 4000°K	
<input type="checkbox"/> W 2700°K	

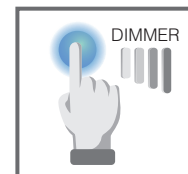









# Kampas Info



## Descrizione *Description*

Profilo angolare in alluminio estruso anodizzato, installazione a plafone su punti ad angolo in orizzontale o verticale. Schermo in policarbonato opalino, 30.000 ore di durata, facile connessione mediante cavo con attacco rapido.

*Corner profile made of anodized extruded aluminium, ceiling installation on horizontal or vertical corner points. Opal polycarbonate screen, 30,000 hours life, easy electrical connection using cable with quick connector.*

## Lunghezze disponibili *Available lengths*

- 400mm 447mm
- 550mm 597mm
- 850mm 897mm
- 1150mm 1197mm

## Potenze LED disponibili *Available LED powers*

## Scala 1:1 *Scale 1:1*

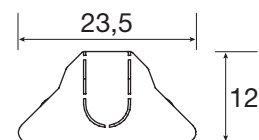
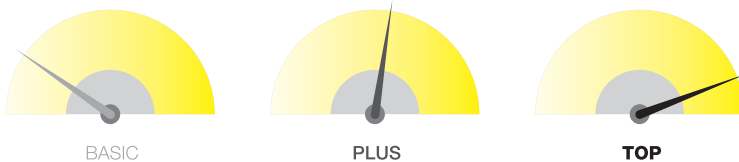

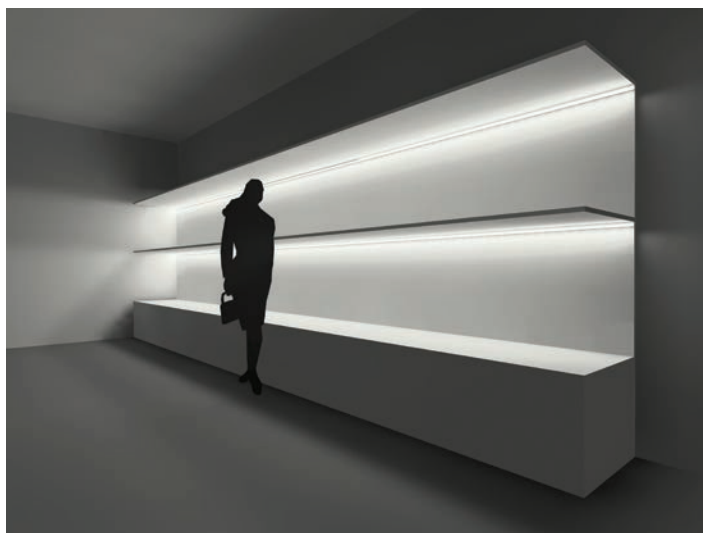
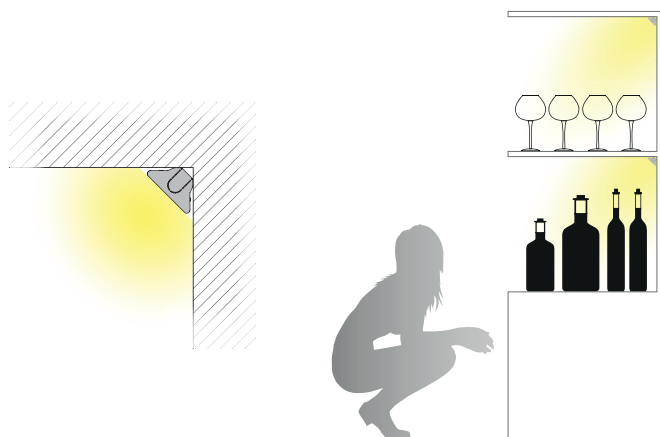

Sistemi di accensione  
Control system

STANDARD  
STANDARD

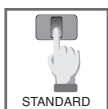

Accensione da prevedere con interruttore a parete o con sistemi remoti (pag 140-141)  
*Switching on and off should be provided via wall switch or with remote systems (page 140-141)*

SENSORE TOUCH  
TOUCH SENSOR



T

Accensione/spengimento tramite tocco su punto indicato da LED blu.  
*Switching on/off is possible by touching the point indicated by the blue LED.*

SENSORE TOUCH/DIMMER  
TOUCH/DIMMER SENSOR



TD

Accensione/spengimento e dimmerazione tramite tocco su punto indicato da LED blu.  
*Switching on/off and dimming is possible by touching the point indicated by the blue LED.*

SENSORE PIR  
PIR SENSOR



S

Accensione tramite rilevamento, spegnimento automatico dopo 30" di mancato rilevamento.  
*Power on by detection, switches off automatically after 30" of no detection.*

Applicazione  
Application

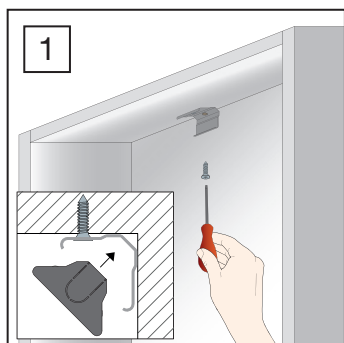

La staffa di fissaggio per le barre KAMPAS viene fissata alla superficie angolare desiderata tramite vite.

*The fixing bracket for the KAMPAS bars is secured to the desired corner surface using screws.*

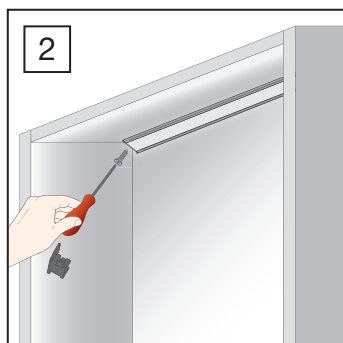

Possibilità di fissare la barra KAMPAS con viti direttamente sulla superficie.

*The KAMPAS bar can be secured with screws directly onto the surface.*





# Kampas

versione standard  
standard version

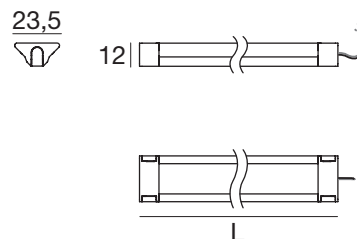

FINITURA FINISH		L.	kg	Kampas BASIC			Kampas PLUS			Kampas TOP			COLORE COLOUR	OTTICA OPTICS
		→		LED's LED's	POTENZA POWER	CODICE CODE	LED's LED's	POTENZA POWER	CODICE CODE	LED's LED's	POTENZA POWER	CODICE CODE		
		400 mm	0,15	18	1,4 W	ER0177	42	3,4 W	ER0362	84	6,7 W	ER0187	<input type="checkbox"/> C 5000°K	<input type="checkbox"/> 0
Anod. Al.		550 mm	0,21	30	2,4 W	ER0178	60	4,8 W	ER0363	120	9,6 W	ER0188	<input type="checkbox"/> N 4000°K	<input type="checkbox"/> 0
		850 mm	0,32	48	3,8 W	ER0179	96	7,7 W	ER0364	192	15,4 W	ER0189	<input type="checkbox"/> W 2700°K	<input type="checkbox"/> 0
		1150 mm	0,42	66	5,3 W	ER0180	132	10,6 W	ER0365	264	21,1 W	ER0190		<input type="checkbox"/> 0

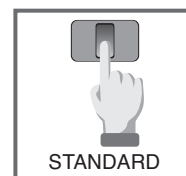

# Kampas T

accensione e spegnimento tramite tocco su punto indicato dal LED blu  
switching on/off is possible by touching the point indicated by the blue LED

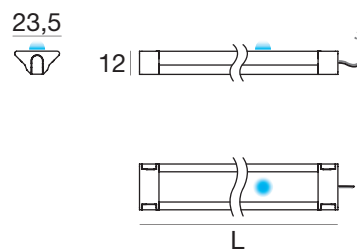

FINITURA FINISH		L.	kg	Kampas T BASIC			Kampas T PLUS			Kampas T TOP			COLORE COLOUR	OTTICA OPTICS
		→		LED's LED's	POTENZA POWER	CODICE CODE	LED's LED's	POTENZA POWER	CODICE CODE	LED's LED's	POTENZA POWER	CODICE CODE		
		447 mm	0,16	18	1,4 W	ER0720	42	3,4 W	ER0724	84	6,7 W	ER0728	<input type="checkbox"/> C 5000°K	<input type="checkbox"/> 0
Anod. Al.		597 mm	0,22	30	2,4 W	ER0721	60	4,8 W	ER0725	120	9,6 W	ER0729	<input type="checkbox"/> N 4000°K	<input type="checkbox"/> 0
		897 mm	0,34	48	3,8 W	ER0722	96	7,7 W	ER0726	192	15,4 W	ER0730	<input type="checkbox"/> W 2700°K	<input type="checkbox"/> 0
		1197 mm	0,44	66	5,3 W	ER0723	132	10,6 W	ER0727	264	21,1 W	ER0731		<input type="checkbox"/> 0





# Kampas TD

accensione, spegnimento e dimmerazione (da 10% a 100%) tramite tocco su punto indicato dal LED blu  
switching on/off and dimming (from 10% to 100%) is possible by touching the point indicated by the blue LED



23,5

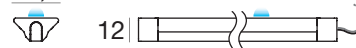

12



FINITURA FINISH	L.	kg
	447 mm	0,16
Anod. Al.	597 mm	0,22
	897 mm	0,34
	1197 mm	0,44

## Kampas TD BASIC

LED's LED's	POTENZA POWER	CODICE CODE
18	1,4 W	ER1162
30	2,4 W	ER1163
48	3,8 W	ER1164
66	5,3 W	ER1165

## Kampas TD PLUS

LED's LED's	POTENZA POWER	CODICE CODE
42	3,4 W	ER1166
60	4,8 W	ER1167
96	7,7 W	ER1168
132	10,6 W	ER1169

## Kampas TD TOP

LED's LED's	POTENZA POWER	CODICE CODE
84	6,7 W	ER1170
120	9,6 W	ER1171
192	15,4 W	ER1172
264	21,1 W	ER1173

COLORE COLOUR	OTTICA OPTICS
<input type="checkbox"/> C 5000°K	<input type="checkbox"/> 0
<input type="checkbox"/> N 4000°K	
<input type="checkbox"/> W 2700°K	

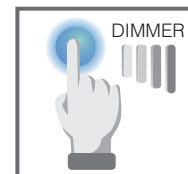

# Kampas S

accensione tramite sensore di presenza PIR, spegnimento automatico dopo 30"  
switching on by means of a PIR detector, switches off automatically after 30"



23,5

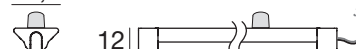

12

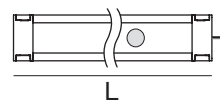

FINITURA FINISH	L.	kg
	400 mm	0,15
Anod. Al.	550 mm	0,19
	850 mm	0,31
	1150 mm	0,41

## Kampas S BASIC

LED's LED's	POTENZA POWER	CODICE CODE
18	1,4 W	ER0317
24	1,9 W	ER0318
42	3,4 W	ER0319
60	4,8 W	ER0320

## Kampas S PLUS

LED's LED's	POTENZA POWER	CODICE CODE
36	2,9 W	ER0366
54	4,3 W	ER0367
90	7,2 W	ER0368
126	10,1 W	ER0369

## Kampas S TOP

LED's LED's	POTENZA POWER	CODICE CODE
72	5,8 W	ER0321
108	8,6 W	ER0322
180	14,4 W	ER0323
252	20,2 W	ER0324

COLORE COLOUR	OTTICA OPTICS
<input type="checkbox"/> C 5000°K	<input type="checkbox"/> 0
<input type="checkbox"/> N 4000°K	
<input type="checkbox"/> W 2700°K	







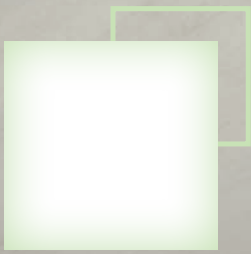

# Nook Info



## Descrizione *Description*

Profilo angolare in alluminio estruso anodizzato, Installazione sui fianchi del mobile, grazie a specifiche staffe di sostegno. Ideale per illuminazione di basi con anta o cassetti e cestoni. Accensione automatica con sensore di presenza integrato.

*Corner profile made of anodized extruded aluminium, mounting on the side of the furniture thanks to specific fixing brackets. Ideal for lighting closets with doors or drawers and deep drawers. Switching on is automatic with a built-in presence detector.*

## Potenze LED disponibili *Available LED powers*



BASIC



PLUS



TOP

## Lunghezze disponibili *Available lengths*

400mm

550mm

850mm

1150mm

## Scala 1:1 *Scale 1:1*

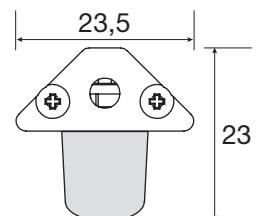

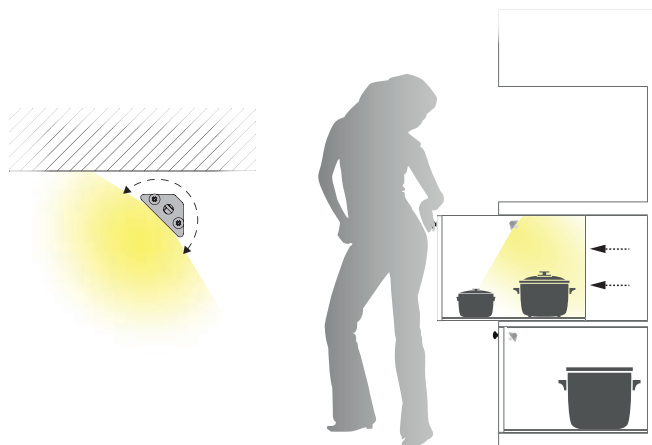

Sistemi di accensione  
Control system

SENSORE PIR  
PIR SENSOR



S

Accensione tramite rilevamento, spegnimento automatico dopo 30" di mancato rilevamento.  
Switching on by detection, switches off automatically after 30" seconds of no detection.

Applicazione  
Application

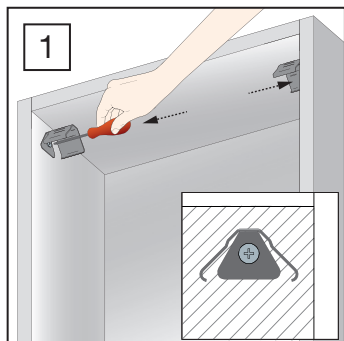

Se la superficie orizzontale non è perforabile, le staffe di fissaggio vengono fissate sulle superfici laterali.

*If the horizontal surface cannot be pierced, the fixing brackets are secured on the lateral surfaces.*

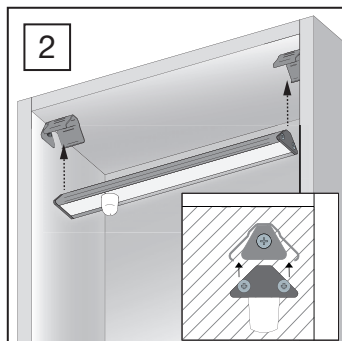

Agganciare la barra NOOK S alle staffe.

*Hook the NOOK S bar onto the brackets.*

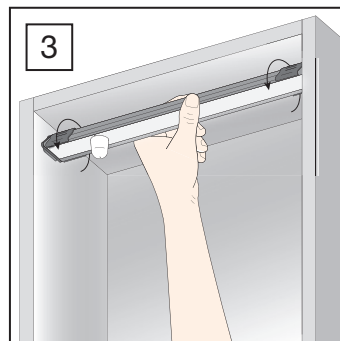

Le staffe possono ruotare per orientare a piacere il fascio luminoso.

*The brackets can rotate to direct the light beam as desired.*

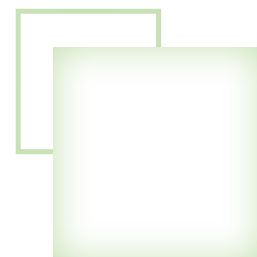



# Nook S

accensione tramite sensore di presenza PIR, spegnimento automatico dopo 30"  
switching on by means of a PIR detector, switches off automatically after 30"

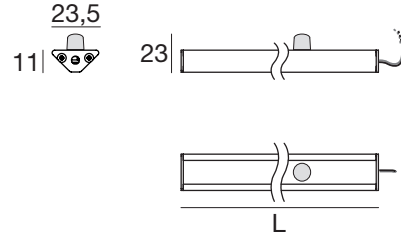

FINITURA FINISH	L.	kg
	400 mm	0,15
Anod. Al.	550 mm	0,21
	850 mm	0,32
	1150 mm	0,42

## Nook S BASIC

LED's LED's	POTENZA POWER	CODICE CODE
18	1,4 W	<b>ER0570</b>
24	1,9 W	<b>ER0571</b>
42	3,4 W	<b>ER0572</b>
60	4,8 W	<b>ER0573</b>

## Nook S PLUS

LED's LED's	POTENZA POWER	CODICE CODE
36	2,9 W	<b>ER0574</b>
54	4,3 W	<b>ER0575</b>
90	7,2 W	<b>ER0576</b>
126	10,1 W	<b>ER0577</b>

## Nook S TOP

LED's LED's	POTENZA POWER	CODICE CODE
72	5,8 W	<b>ER0578</b>
108	8,6 W	<b>ER0579</b>
180	14,4 W	<b>ER0580</b>
252	20,2 W	<b>ER0581</b>

COLORE COLOUR	OTTICA OPTICS
<input type="checkbox"/> C 5000°K	<input type="checkbox"/> 0
<input type="checkbox"/> N 4000°K	
<input type="checkbox"/> W 2700°K	





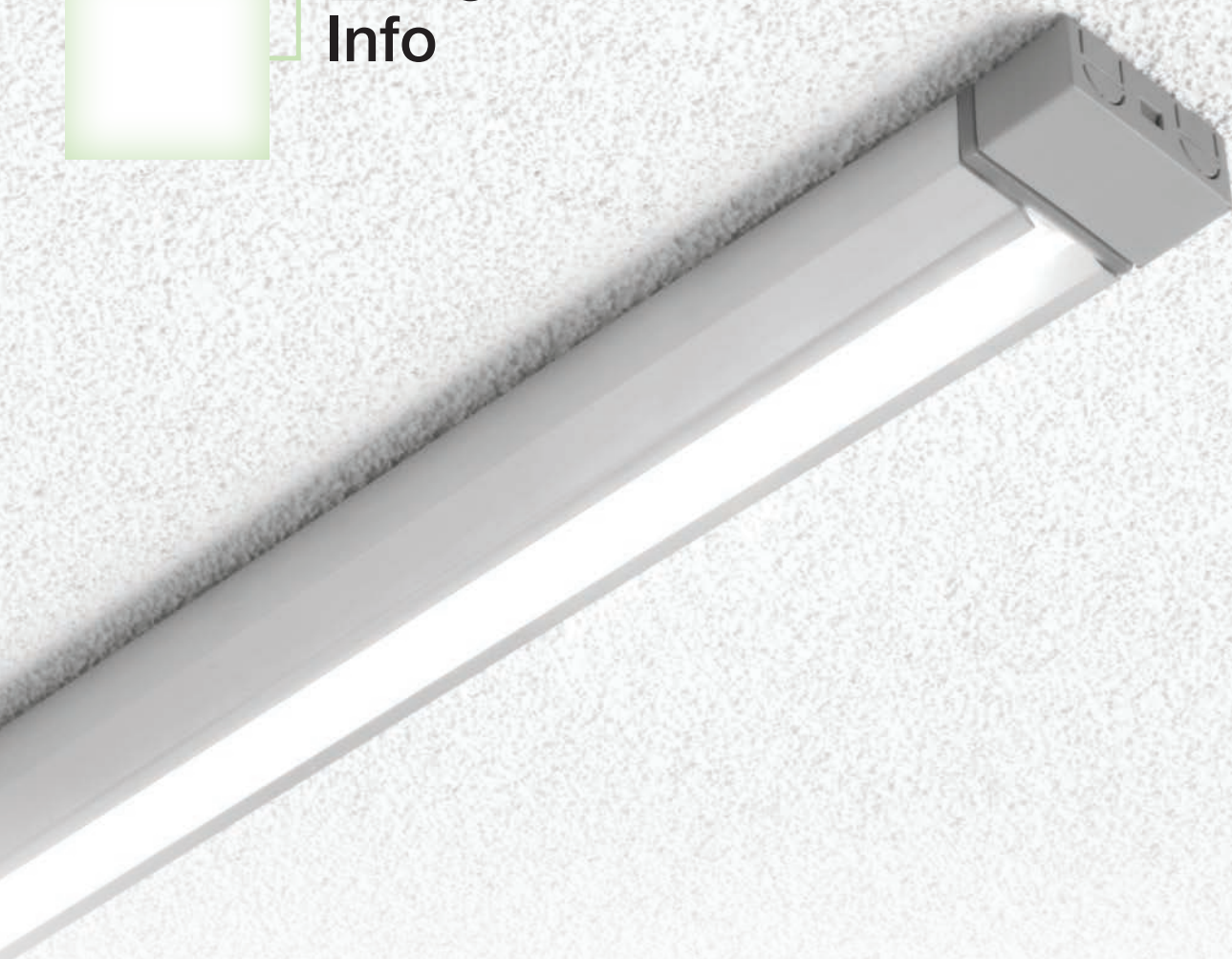
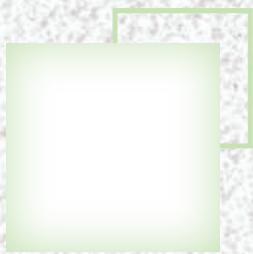

## Descrizione *Description*

Profilo rettangolare in alluminio anodizzato, installazione a plafone tramite viti autofilettanti. Alimentazione remota con driver a tensione costante. Luce direzionata asimmetrica anti-abbagliamento.

*Anodized rectangular aluminium profile, recessed installation. Surface mounting using self-tapping screws Remote power supply with constant-voltage driver. Anti-glare asymmetrical directed light.*

## Potenze LED disponibili *Available LED powers*



BASIC

## Lunghezze disponibili *Available lengths*

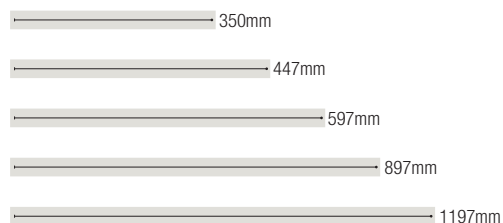

## Scala 1:1 *Scale 1:1*

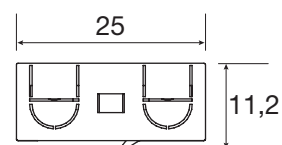

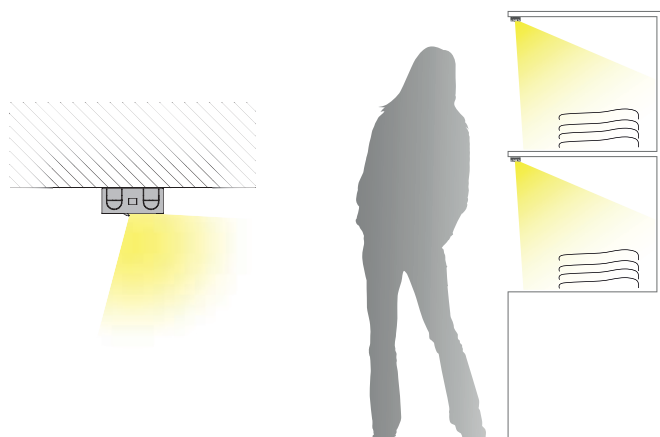

Sistemi di accensione  
*Control system*

STANDARD  
 STANDARD

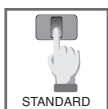

Accensione da prevedere con interruttore a parete o con sistemi remoti (pag 140-141)  
*Switching on and off should be provided via wall switch or with remote systems (page 140-141)*

INTERRUTTORE MECCANICO  
 MECHANICAL SWITCH



B

Accensione/spengimento tramite interruttore meccanico.  
*Power on/off by means of a mechanical switch.*

Applicazione  
*Application*

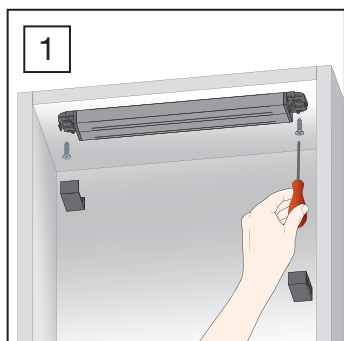

Le barre LINUL con lunghezza 400mm e 550mm vengono fissate con viti direttamente sulla superficie.

*The 400mm and 550mm long LINUL bars are secured with screws directly onto the surface.*

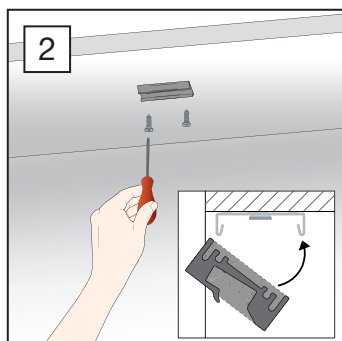

Le barre LINUL con lunghezza 850mm e 1850mm necessitano di una molla di sostegno nel punto centrale del profilo.

*The 850mm and 1850mm long LINUL bars require a support spring in the centre part of the profile.*

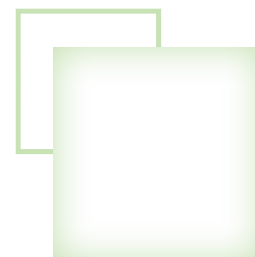



# Linul

versione standard  
standard version

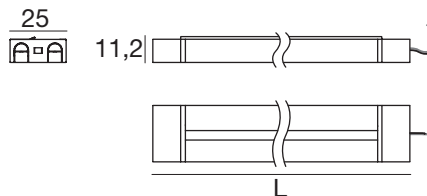

FINITURA FINISH		L.	kg	Linul BASIC			COLORE COLOUR		OTTICA OPTICS
		→		LED's LED's	POTENZA POWER	CODICE CODE			
		350 mm	0,16	18	1,4 W	<b>ER0795</b>	<input type="checkbox"/> C		
		447 mm	0,19	24	1,9 W	<b>ER0796</b>	<input type="checkbox"/> 5000°K		
Anod. Al.		597 mm	0,23	30	2,4 W	<b>ER0797</b>	<input type="checkbox"/> N		
		897 mm	0,32	48	3,8 W	<b>ER0798</b>	<input type="checkbox"/> 4000°K		
		1197 mm	0,41	66	5,3 W	<b>ER0799</b>	<input type="checkbox"/> W		
							<input type="checkbox"/> 2700°K		

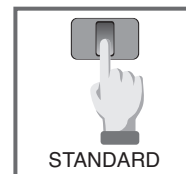

# Linul B

accensione/spegnimento tramite interruttore meccanico  
power on/off by means of a mechanical switch

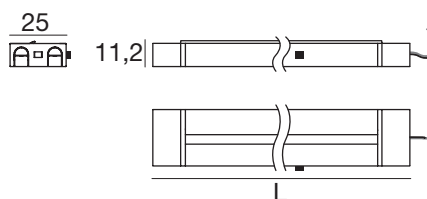

FINITURA FINISH		L.	kg	Linul B BASIC			COLORE COLOUR		OTTICA OPTICS
		→		LED's LED's	POTENZA POWER	CODICE CODE			
		350 mm	0,16	18	1,4 W	<b>ER0800</b>	<input type="checkbox"/> C		
		447 mm	0,19	24	1,9 W	<b>ER0801</b>	<input type="checkbox"/> 5000°K		
Anod. Al.		597 mm	0,23	30	2,4 W	<b>ER0802</b>	<input type="checkbox"/> N		
		897 mm	0,32	48	3,8 W	<b>ER0803</b>	<input type="checkbox"/> 4000°K		
		1197 mm	0,41	66	5,3 W	<b>ER0804</b>	<input type="checkbox"/> W		
							<input type="checkbox"/> 2700°K		







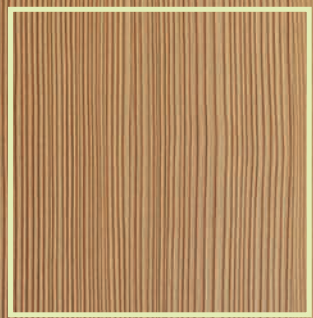

# RECESSED PROFILES

La linea RECESSED PROFILES è composta da profili versatili che soddisfano svariate esigenze di installazione. Luce e materia si fondono: le dimensioni ridotte dei profili e l'installazione ad incasso generano un'integrazione armoniosa tra luce e materia. Le barre RECESSED PROFILE offrono un'illuminazione uniforme e sono disponibili nelle varianti basic, plus e top.

*The RECESSED PROFILES range is made up of versatile bars that meet various installation requirements. Light and material come together: thanks to its small size and its recessed installation, this generates a harmonious integration of light and material. RECESSED PROFILES provide uniform illumination and are available basic, plus and top versions.*



Symmetric emission

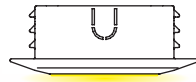
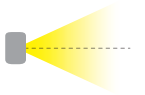

Hid Slim page 64

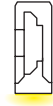

Sign page 70

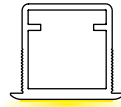

Sly page 74

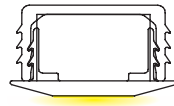

Forma page 78

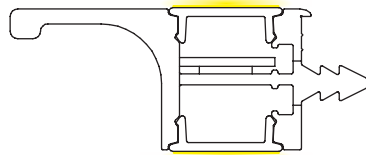

Firion page 82

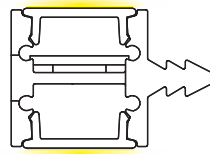

Shelf page 88

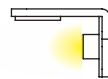

L-strip page 92

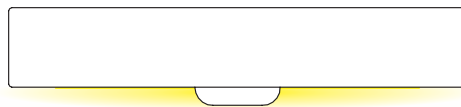

X-fon page 96

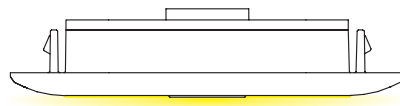

I-fon page 100

Asymmetric emission

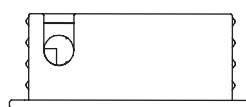
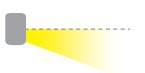

Moon page 104



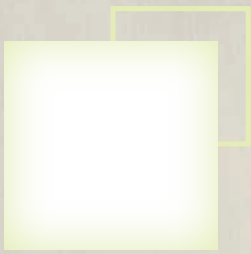

# Hid Slim Info



## Descrizione Description

Profilo rettangolare in alluminio anodizzato, installazione ad incasso in soli 7mm, diffusore opalino in policarbonato. Tappi quadrati della stessa finitura del profilo.

*Rectangular anodized aluminium profile, recessed installation in just 7mm, opal polycarbonate screen. Squared caps with the same finish as the bar.*

## Lunghezze disponibili Available lengths

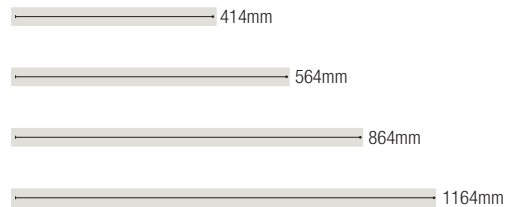

## Potenze LED disponibili Available LED powers

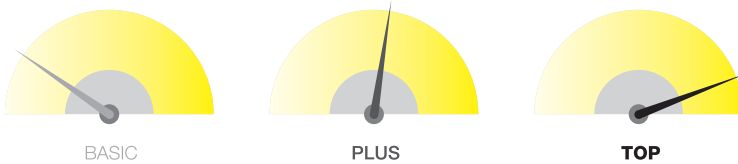

## Scala 1:1 Scale 1:1

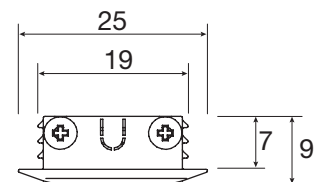

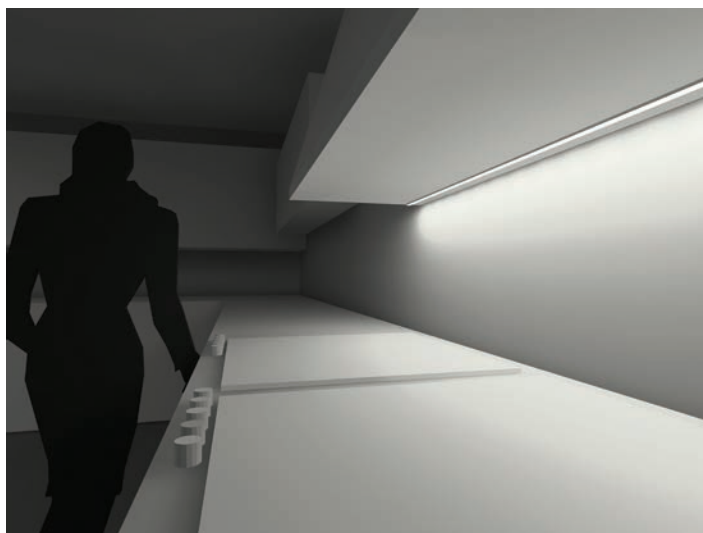
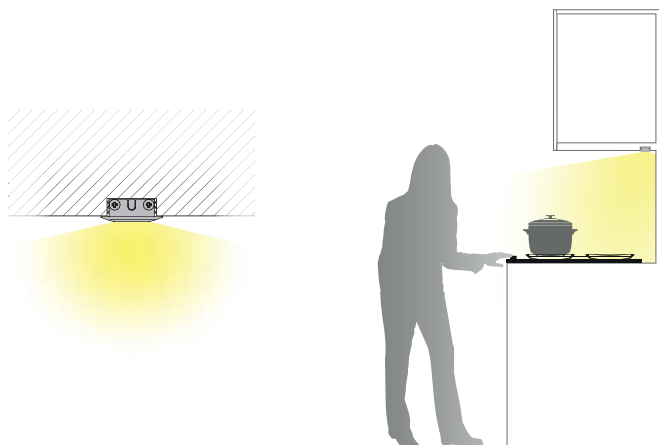

Sistemi di accensione  
Control system

STANDARD  
STANDARD

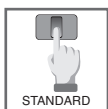

Accensione da prevedere con interruttore a parete o con sistemi remoti (pag 140-141)  
*Switching on and off should be provided via wall switch or with remote systems (page 140-141)*

SENSORE TOUCH  
TOUCH SENSOR



T

Accensione/spegnimento tramite tocco su punto indicato da LED blu.  
*Switching on/off is possible by touching the point indicated by the blue LED.*

SENSORE TOUCH/DIMMER  
TOUCH/DIMMER SENSOR



TD

Accensione/spegnimento e dimmerazione tramite tocco su punto indicato da LED blu.  
*Switching on/off and dimming is possible by touching the point indicated by the blue LED.*

SENSORE DI PROSSIMITÀ  
PROXIMITY SENSOR

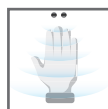

P

Sensore di prossimità, accensione/spegnimento tramite mano nei pressi del sensore.  
*Proximity sensor, switching on/off takes place passing a hand near the sensor.*

SENSORE PIR  
PIR SENSOR



S

Accensione tramite rilevamento, spegnimento automatico dopo 30" di mancato rilevamento.  
*Switching on by detection, switches off automatically after 30" seconds of no detection.*

Applicazione  
Application

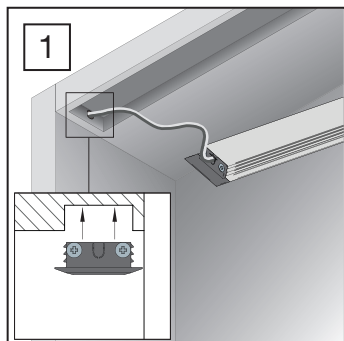

Le barre HID SLIM vengono fissate ad incasso senza l'uso di viti.

*The HID SLIM bars are mounted recessed without using screws.*

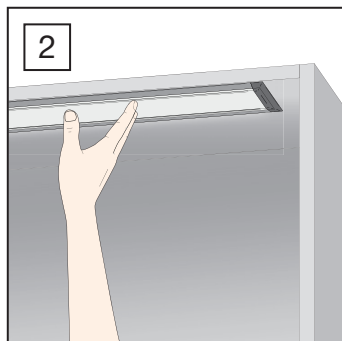

Installazione direttamente su apposita fresata nel legno.

*Installation directly on a special groove in the wood.*

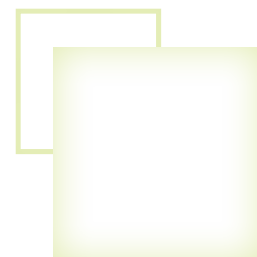

# Hid Slim

versione standard  
standard version

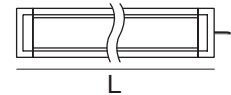
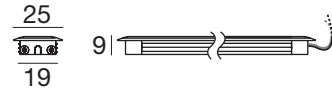

FINITURA FINISH	L. →	kg	HID Slim BASIC			HID Slim PLUS			HID Slim TOP			COLORE COLOUR	OTTICA OPTICS
			LED's LED's	POTENZA POWER	CODICE CODE	LED's LED's	POTENZA POWER	CODICE CODE	LED's LED's	POTENZA POWER	CODICE CODE		
	414 mm	0,12	18	1,4 W	ER0514	42	3,4 W	ER0519	84	6,7 W	ER0524	<input type="checkbox"/> C 5000°K	<input type="checkbox"/> 0
Anod. Al.	564 mm	0,17	30	2,4 W	ER0515	60	4,8 W	ER0520	120	9,6 W	ER0525	<input type="checkbox"/> N 4000°K	
	864 mm	0,26	48	3,8 W	ER0516	96	7,7 W	ER0521	192	15,4 W	ER0526	<input type="checkbox"/> W 2700°K	
	1164 mm	0,35	66	5,3 W	ER0517	132	10,6 W	ER0522	264	21,1 W	ER0527		

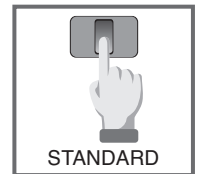

# Hid Slim T

accensione e spegnimento tramite tocco su punto indicato dal LED blu  
switching on/off is possible by touching the point indicated by the blue LED

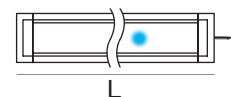

FINITURA FINISH	L. →	kg	HID Slim T BASIC			HID Slim T PLUS			HID Slim T TOP			COLORE COLOUR	OTTICA OPTICS
			LED's LED's	POTENZA POWER	CODICE CODE	LED's LED's	POTENZA POWER	CODICE CODE	LED's LED's	POTENZA POWER	CODICE CODE		
	414 mm	0,13	18	1,4 W	ER0630	36	2,9 W	ER0634	72	5,8 W	ER0638	<input type="checkbox"/> C 5000°K	<input type="checkbox"/> 0
Anod. Al.	564 mm	0,18	24	1,9 W	ER0631	54	4,3 W	ER0635	108	8,5 W	ER0639	<input type="checkbox"/> N 4000°K	
	864 mm	0,27	42	3,4 W	ER0632	90	7,2 W	ER0636	180	14,4 W	ER0640	<input type="checkbox"/> W 2700°K	
	1164 mm	0,35	60	4,8 W	ER0633	126	10,1 W	ER0637	252	20,2 W	ER0641		

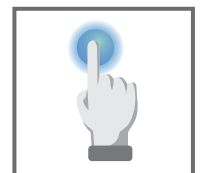

# Hid Slim TD

accensione, spegnimento e dimmerazione (da 10% a 100%) tramite tocco su punto indicato dal LED blu  
*switching on/off and dimming (from 10% to 100%) is possible by touching the point indicated by the blue LED*

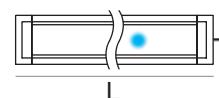
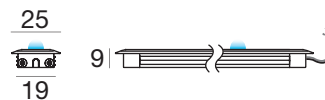

FINITURA FINISH	L. →	kg	HID Slim TD BASIC			HID Slim TD PLUS			HID Slim TD TOP		
			LED's LED's	POTENZA POWER	CODICE CODE	LED's LED's	POTENZA POWER	CODICE CODE	LED's LED's	POTENZA POWER	CODICE CODE
	414 mm	0,13	18	1,4 W	ER1174	36	2,9 W	ER1178	72	5,8 W	ER1182
Anod. Al.	564 mm	0,18	24	1,9 W	ER1175	54	4,3 W	ER1179	108	8,5 W	ER1183
	864 mm	0,27	42	3,4 W	ER1176	90	7,2 W	ER1180	180	14,4 W	ER1184
	1164 mm	0,35	60	4,8 W	ER1177	126	10,1 W	ER1181	252	20,2 W	ER1185

COLORE COLOUR	OTTICA OPTICS
<input type="checkbox"/> C 5000°K	<input type="checkbox"/> 0
<input type="checkbox"/> N 4000°K	
<input type="checkbox"/> W 2700°K	

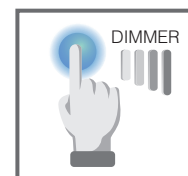

# Hid Slim P

accensione e spegnimento tramite passaggio di una mano nei pressi del sensore (senza contatto)  
*switching on and off by passing a hand near the sensor (without contact)*

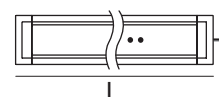
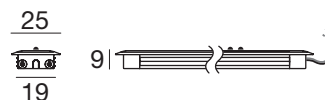

FINITURA FINISH	L. →	kg	HID Slim P BASIC			HID Slim P PLUS			HID Slim P TOP		
			LED's LED's	POTENZA POWER	CODICE CODE	LED's LED's	POTENZA POWER	CODICE CODE	LED's LED's	POTENZA POWER	CODICE CODE
	414 mm	0,13	18	1,4 W	ER0606	36	2,9 W	ER0610	72	5,8 W	ER0614
Anod. Al.	564 mm	0,18	24	1,9 W	ER0607	54	4,3 W	ER0611	108	8,5 W	ER0615
	864 mm	0,27	42	3,4 W	ER0608	90	7,2 W	ER0612	180	14,4 W	ER0616
	1164 mm	0,35	60	4,8 W	ER0609	126	10,1 W	ER0613	252	20,2 W	ER0617

COLORE COLOUR	OTTICA OPTICS
<input type="checkbox"/> C 5000°K	<input type="checkbox"/> 0
<input type="checkbox"/> N 4000°K	
<input type="checkbox"/> W 2700°K	

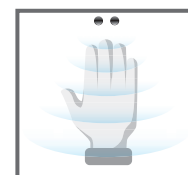



# Hid Slim S

accensione tramite sensore di presenza PIR, spegnimento automatico dopo 30"  
*switching on by means of a PIR detector, switches off automatically after 30"*

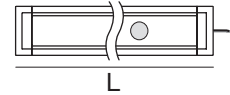
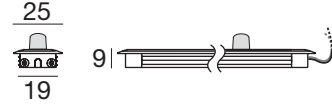
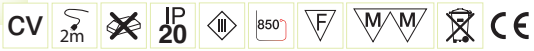

FINITURA FINISH	L.	kg
	414 mm	0,13
Anod. Al.	564 mm	0,18
	864 mm	0,27
	1164 mm	0,35

HID Slim S BASIC		
LED's LED's	POTENZA POWER	CODICE CODE
18	1,4 W	<b>ER0540</b>
24	1,9 W	<b>ER0541</b>
42	3,4 W	<b>ER0542</b>
60	4,8 W	<b>ER0543</b>

HID Slim S PLUS		
LED's LED's	POTENZA POWER	CODICE CODE
36	2,9 W	<b>ER0544</b>
54	4,3 W	<b>ER0545</b>
90	7,2 W	<b>ER0546</b>
126	10,1 W	<b>ER0547</b>

HID Slim S TOP		
LED's LED's	POTENZA POWER	CODICE CODE
72	5,8 W	<b>ER0548</b>
108	8,6 W	<b>ER0549</b>
168	14,4 W	<b>ER0550</b>
252	20,2 W	<b>ER0551</b>

COLORE COLOUR	OTTICA OPTICS
<input type="checkbox"/> C 5000°K	<input type="checkbox"/> 0
<input type="checkbox"/> N 4000°K	
<input type="checkbox"/> W 2700°K	







# Sign Info



## Descrizione *Description*

LED strip ad emissione verticale montati su circuito flessibile ricoperta in PVC. Corpo flessibile con diffusore in resina poliuretano autodissipante per creare fantasiosi e sottili "segni" di luce. Facilmente installabile in apposita fresata, può essere piegata o tagliata in unità.

*LED strip integrated in flexible PVC covered circuit with vertical emission. Flexible body with self-dissipating polyurethane resin diffuser to create imaginative and thin "signs" of light. Easily adaptable in any type of application, it can be folded and cut into units.*

## Potenze LED disponibili *Available LED powers*



PLUS

## Lunghezze disponibili *Available lengths*

page 72...\*

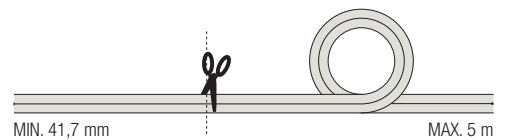

## Scala 1:1 *Scale 1:1*

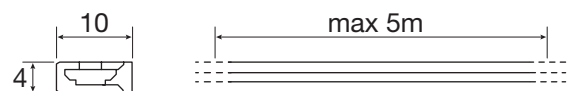

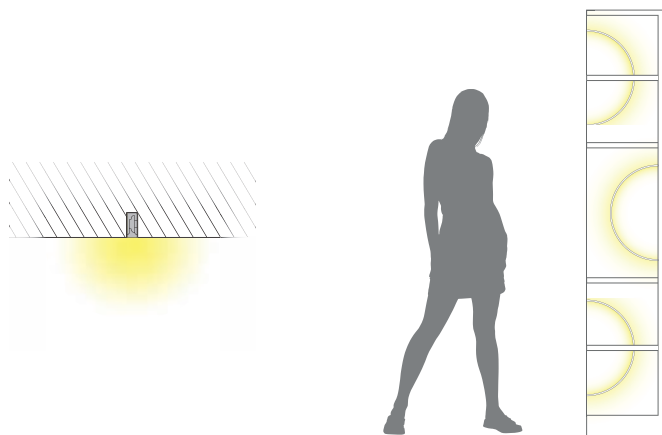

Sistemi di accensione  
*Control system*

STANDARD  
STANDARD

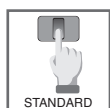

Accensione da prevedere con interruttore a parete o con sistemi remoti (pag 140-141)  
*Switching on and off should be provided via wall switch or with remote systems (page 140-141)*

Applicazione  
*Application*

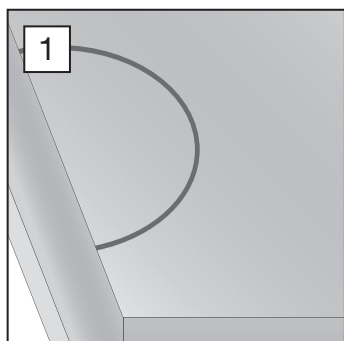

Il profilo SIGN viene installato direttamente su apposita fresata nel legno.

*The SIGN profile is installed directly on a special groove in the wood.*

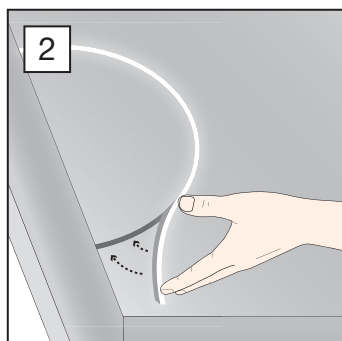

Installazione ad incasso direttamente senza l'uso di viti.

*Recessed installation directly without screws.*

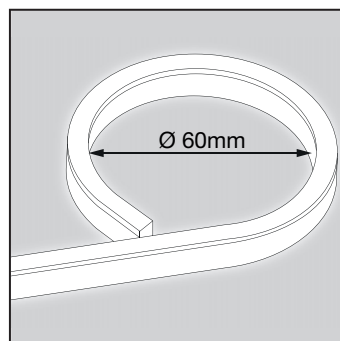

Per scongiurare danneggiamenti, la piega massima del profilo è di 60mm di diametro.

*To avoid damage, the maximum fold of the profile is 60mm in diameter.*

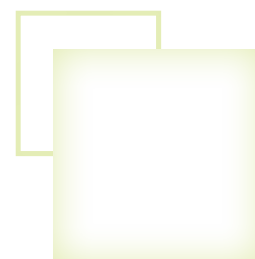



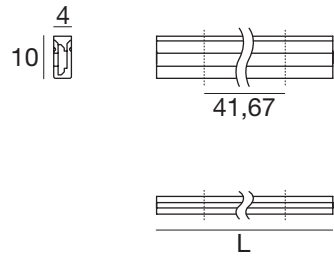

# Sign

versione standard  
standard version



## Sign

VERSIONE VERSION	LED's LED's	POTENZA POWER	CODICE CODE	COLORE COLOUR	OTTICA OPTICS
PLUS 	168	9,6 W	<b>ERS011</b>	<input type="checkbox"/> N 4000°K <input checked="" type="checkbox"/> W 3000°K	 0



\*Composizione codice lunghezza specifica  
\*Code composition for specific length

Per ordinare strip Sign con lunghezza specifica, nella composizione del codice aggiungere il numero della lunghezza desiderata in mm.  
Ad esempio nel caso sia richiesta una strip Sign 3000°K da 1850mm il codice da comporre sarà **ERS011W1850**,  
se è richiesta una rolla da 5m di strip Sign 4000°K il codice da comporre è **ERS011N5000**.

To order specific Sign strip length, in the code composition add the number of the desired length in mm.  
For example if a piece of Sign strip 3000°K of **1850mm** is required, the code to be ordered will be **ERS011W1850**,  
if a piece of **5m** Sign strip 4000°K is required the code to dial is **ERS011N5000**.

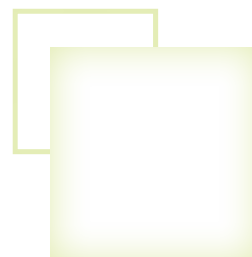

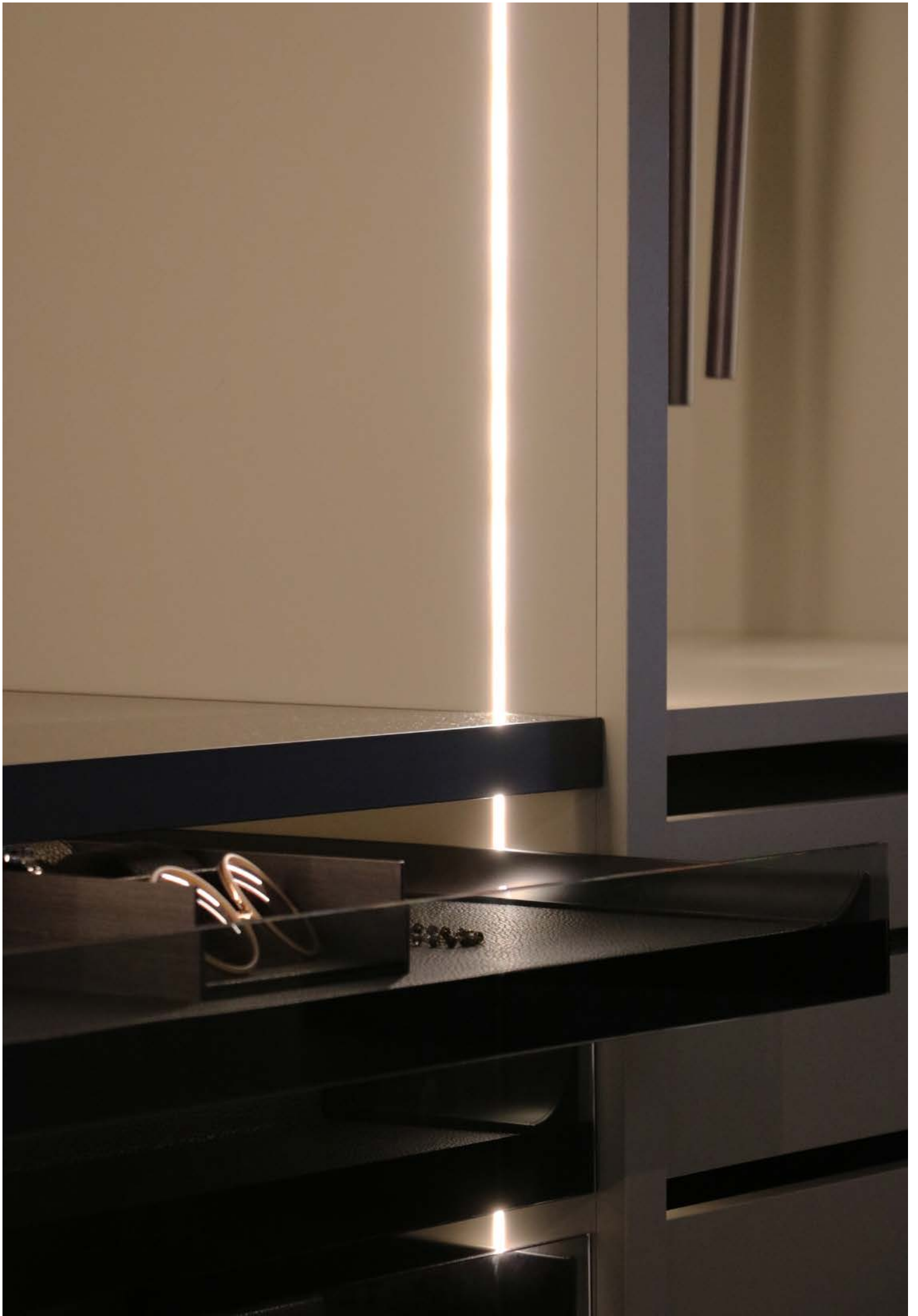







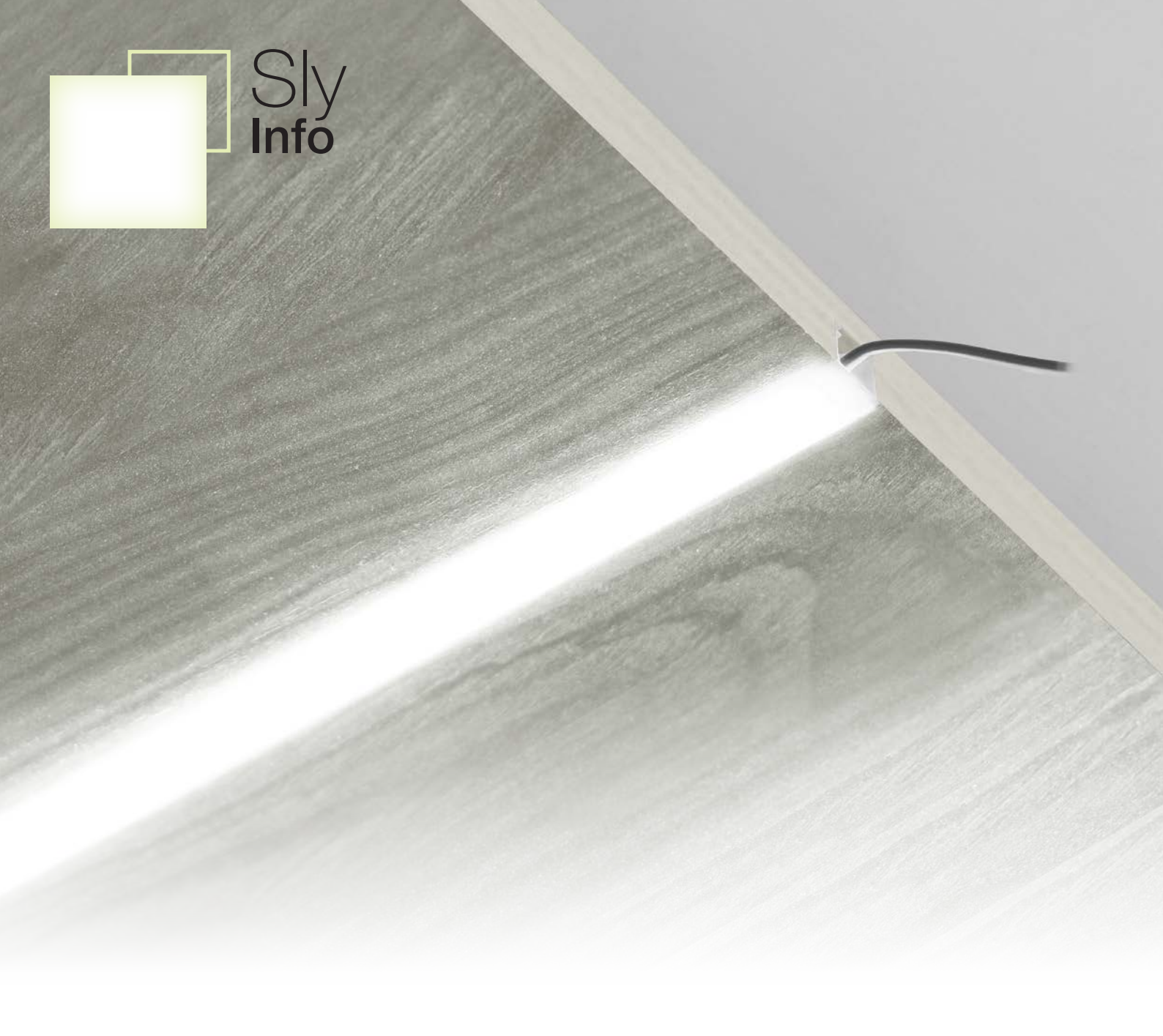

## Descrizione *Description*

Profilo quadrato in policarbonato opale estruso, circuito ad alta intensità con effetto luce di diffusione uniforme. Installazione ad incasso con battuta per incasso su legno. Ideale su fianco armadio o incassato su sottopensili o mensole, facile connessione mediante cavo con attacco rapido.

*Squared profile made of extruded opal polycarbonate, high intensity circuit with uniform light diffusion effect. Recessed installation, ideal for mounting on the side of a wardrobe or under shelves. Easy connection using cable with quick connectors.*

## Potenze LED disponibili *Available LED powers*

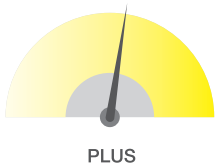

## Lunghezze disponibili *Available lengths*

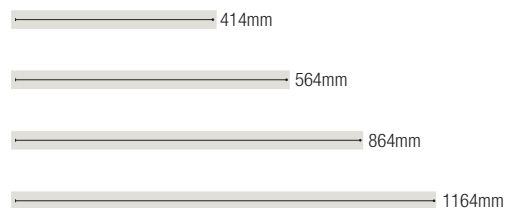

## Scala 1:1 *Scale 1:1*

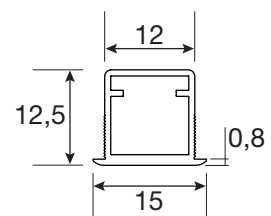



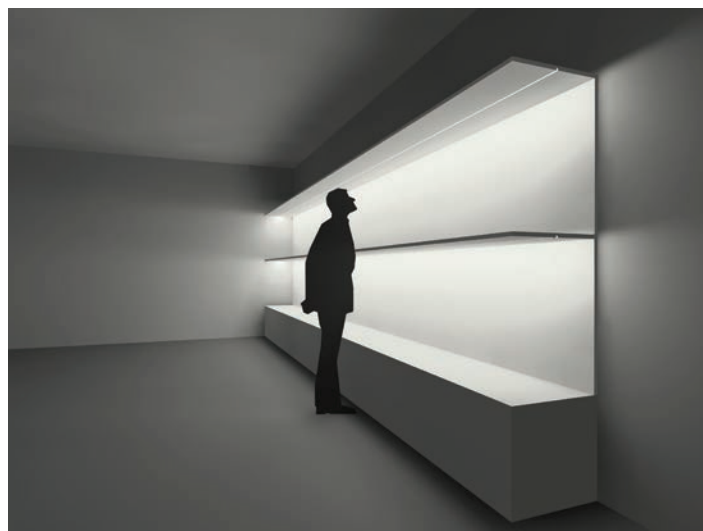
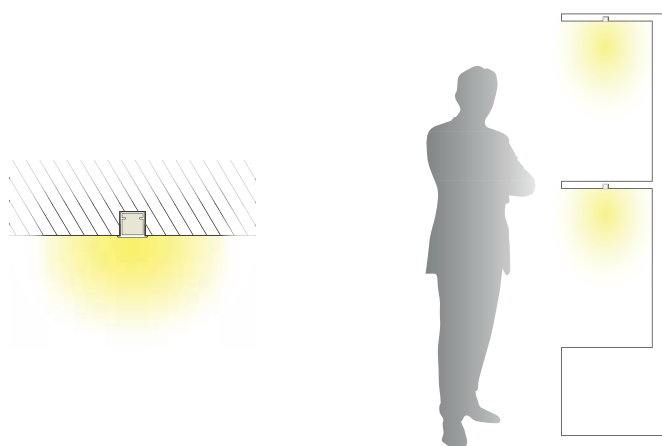

Sistemi di accensione  
Control system

STANDARD  
STANDARD

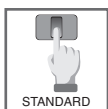

Accensione da prevedere con interruttore a parete o con sistemi remoti (pag 140-141)  
*Switching on and off should be provided via wall switch or with remote systems (page 140-141)*

SENSORE TOUCH  
TOUCH SENSOR



Accensione/spengimento tramite tocco su punto indicato da LED blu.  
*Switching on/off is possible by touching the point indicated by the blue LED.*

Applicazione  
Application

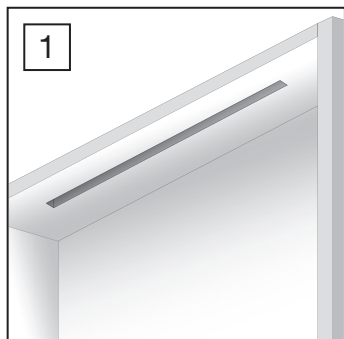

Il profilo SLY viene installato su apposita fresata nel legno.

*The SLY profile is installed on a special groove in the wood.*

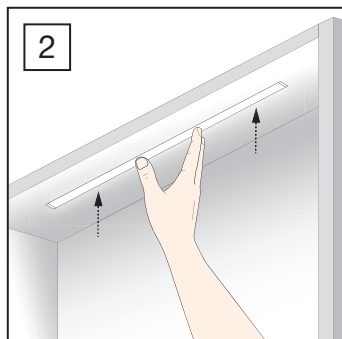

Installazione ad incasso direttamente su apposita fresata nel legno, in posizione orizzontale o verticale.

*Recessed installation directly on special groove in the wood in horizontal or vertical position.*

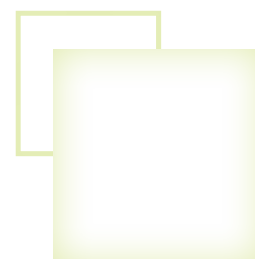

# Sly

versione standard  
standard version

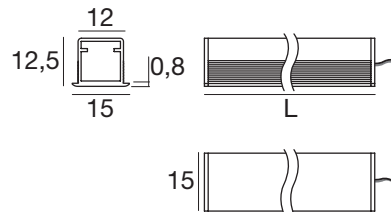

FINITURA FINISH		L.	kg	LED's LED's	POTENZA POWER	CODICE CODE	COLORE COLOUR	OTTICA OPTICS
		414 mm	0,03	48	3,8 W	<b>ER1214</b>	<b>C</b> 5000°K	
Opaline		564 mm	0,04	66	5,3 W	<b>ER1215</b>	<b>N</b> 4000°K	<b>0</b>
		864 mm	0,06	102	8,2 W	<b>ER1216</b>		
		1164 mm	0,08	138	11 W	<b>ER1217</b>		

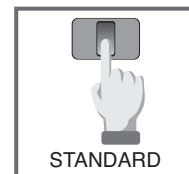

# Sly T

accensione e spegnimento tramite tocco su punto indicato dal LED blu  
switching on/off is possible by touching the point indicated by the blue LED

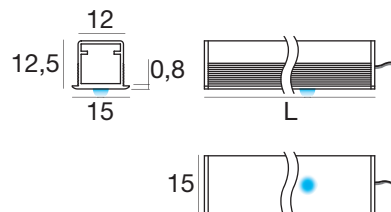

FINITURA FINISH		L.	kg	LED's LED's	POTENZA POWER	CODICE CODE	COLORE COLOUR	OTTICA OPTICS
		414 mm	0,04	42	2,9 W	<b>ER1268</b>	<b>C</b> 5000°K	
Opaline		564 mm	0,05	60	4,3 W	<b>ER1269</b>	<b>N</b> 4000°K	<b>0</b>
		864 mm	0,07	96	7,2 W	<b>ER1270</b>		
		1164 mm	0,09	132	10 W	<b>ER1271</b>		

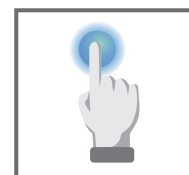





# Forma Info

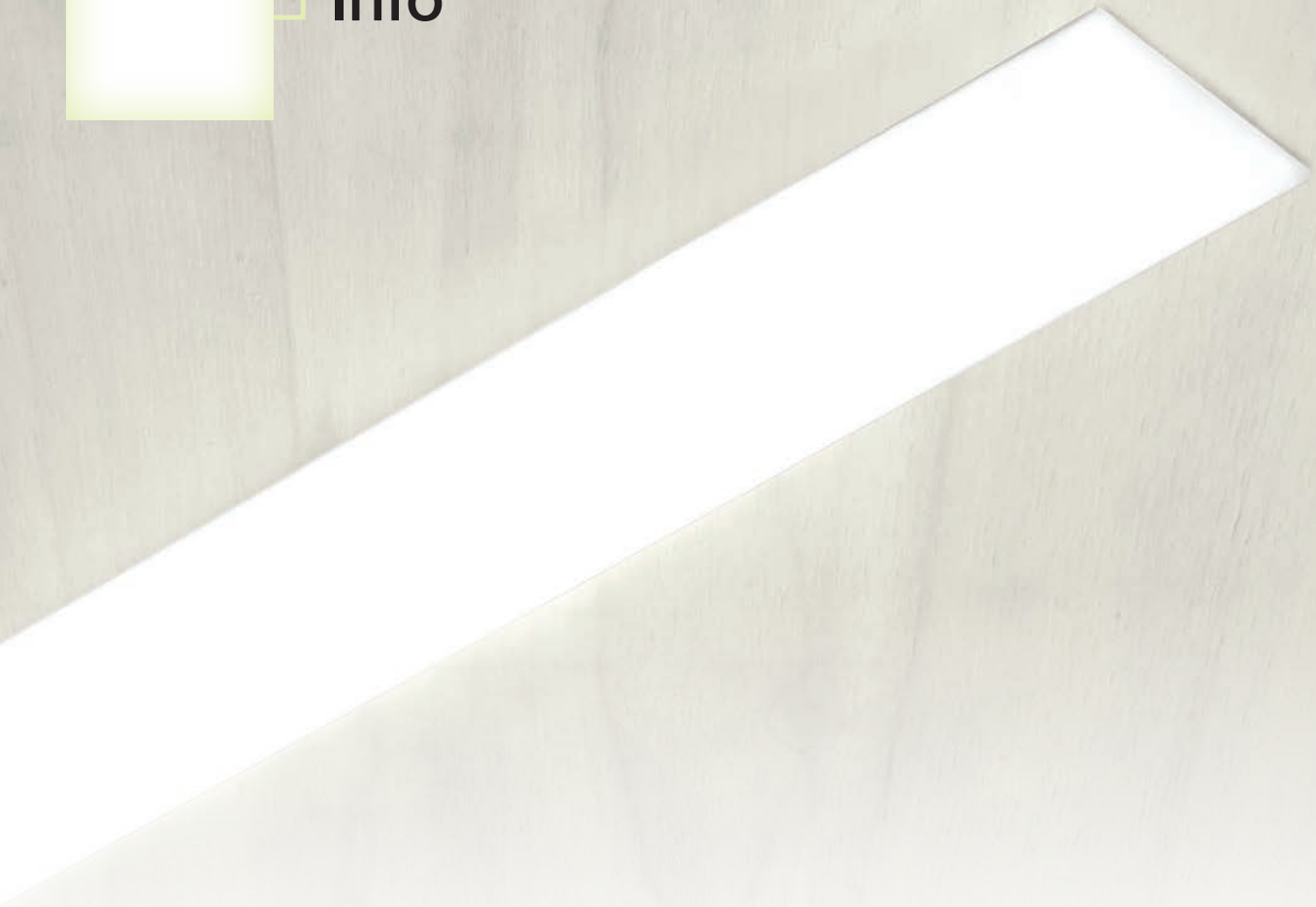

## Descrizione *Description*

Profilo opalino in policarbonato, installazione ad incasso, 30.000 ore di durata, effetto linea di luce continua priva di punti (versioni BASIC, PLUS e TOP).

*Opal polycarbonate profile, recessed installation, 30,000 hours of life, point-free line of light effect (BASIC, PLUS and TOP versions).*

## Lunghezze disponibili *Available lengths*

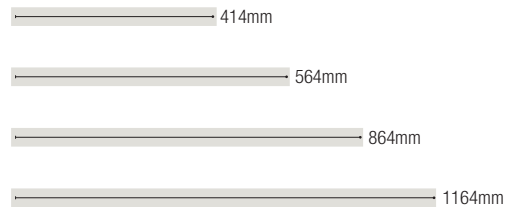

## Potenze LED disponibili *Available LED powers*

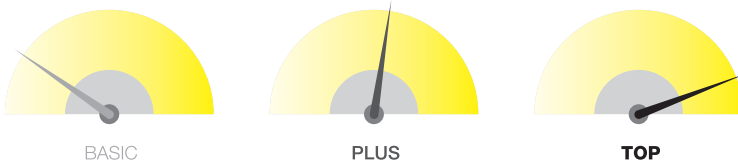

## Scala 1:1 *Scale 1:1*

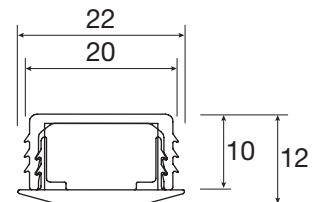



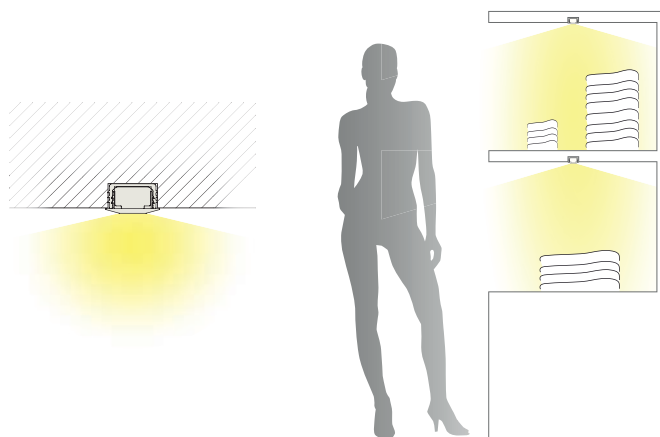

Sistemi di accensione  
Control system

STANDARD  
STANDARD

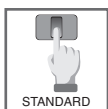

Accensione da prevedere con interruttore a parete o con sistemi remoti (pag 140-141)  
*Switching on and off should be provided via wall switch or with remote systems (page 140-141)*

SENSORE TOUCH  
TOUCH SENSOR



T

Accensione/spegnimento tramite tocco su punto indicato da LED blu.  
*Switching on/off is possible by touching the point indicated by the blue LED.*

SENSORE TOUCH/DIMMER  
TOUCH/DIMMER SENSOR



TD

Accensione/spegnimento e dimmerazione tramite tocco su punto indicato da LED blu.  
*Switching on/off and dimming is possible by touching the point indicated by the blue LED.*

SENSORE PIR  
PIR SENSOR



S

Accensione tramite rilevamento, spegnimento automatico dopo 30" di mancato rilevamento.  
*Switching on by detection, switches off automatically after 30" seconds of no detection.*

Applicazione  
Application

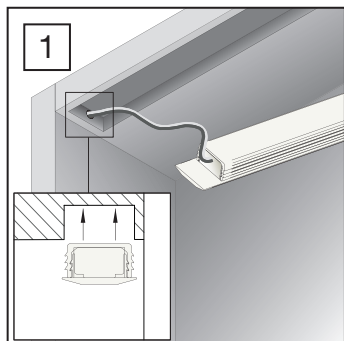

Le barre FORMA vengono fissate ad incasso senza l'uso di viti.

*The FORMA bars are mounted recessed without using screws.*

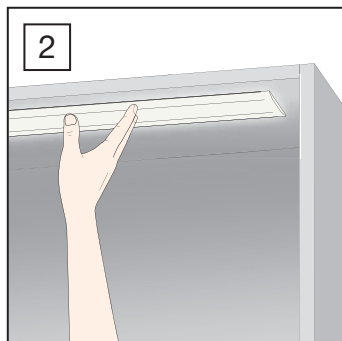

Installazione direttamente su apposita fresata nel legno.

*Installation directly on a special groove in the wood.*

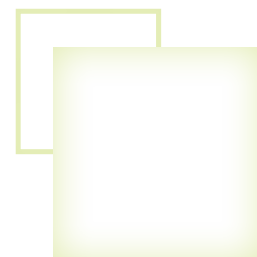



# Forma

versione standard  
standard version

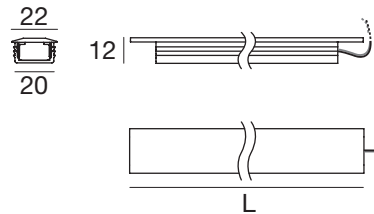

FINITURA FINISH	L. →	kg	Forma BASIC			Forma PLUS			Forma TOP			COLORE COLOUR	OTTICA OPTICS
			LED's LED's	POTENZA POWER	CODICE CODE	LED's LED's	POTENZA POWER	CODICE CODE	LED's LED's	POTENZA POWER	CODICE CODE		
Opaline	414 mm	0,05	18	1,4 W	ER0083	42	3,4 W	ER0418	84	6,7 W	ER0107	<input type="checkbox"/> C 5000°K <input type="checkbox"/> N 4000°K <input type="checkbox"/> W 2700°K	<input checked="" type="checkbox"/> 0
	564 mm	0,07	30	2,4 W	ER0084	60	4,8 W	ER0419	120	9,6 W	ER0108		
	864 mm	0,12	48	3,8 W	ER0085	96	7,7 W	ER0420	192	15,4 W	ER0109		
	1164 mm	0,16	66	5,3 W	ER0299	132	10,6 W	ER0421	264	21,1 W	ER0300		

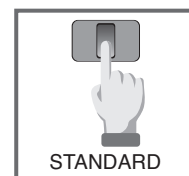

# Forma T

accensione e spegnimento tramite tocco su punto indicato dal LED blu  
switching on/off is possible by touching the point indicated by the blue LED

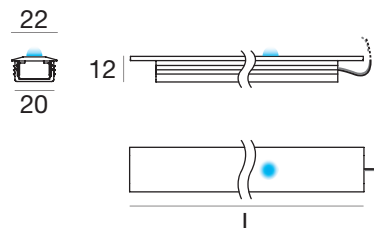

FINITURA FINISH	L. →	kg	Forma T BASIC			Forma T PLUS			Forma T TOP			COLORE COLOUR	OTTICA OPTICS
			LED's LED's	POTENZA POWER	CODICE CODE	LED's LED's	POTENZA POWER	CODICE CODE	LED's LED's	POTENZA POWER	CODICE CODE		
Opaline	414 mm	0,13	18	1,4 W	ER0783	36	2,9 W	ER0787	72	5,8 W	ER0791	<input type="checkbox"/> C 5000°K <input type="checkbox"/> N 4000°K <input type="checkbox"/> W 2700°K	<input checked="" type="checkbox"/> 0
	564 mm	0,18	24	1,9 W	ER0784	54	4,3 W	ER0788	108	8,5 W	ER0792		
	864 mm	0,27	42	3,4 W	ER0785	90	7,2 W	ER0789	180	14,4 W	ER0793		
	1164 mm	0,35	60	4,8 W	ER0786	126	10,1 W	ER0790	252	20,2 W	ER0794		

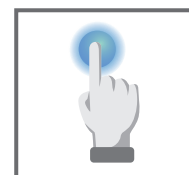

# Forma TD

accensione, spegnimento e dimmerazione (da 10% a 100%) tramite tocco su punto indicato dal LED blu  
*switching on/off and dimming (from 10% to 100%) is possible by touching the point indicated by the blue LED*

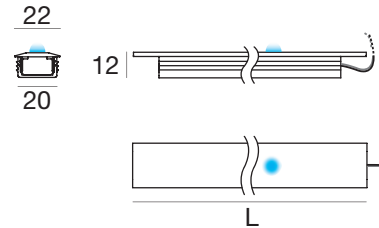

FINITURA FINISH	L. →	kg
	414 mm	0,13
Opaline	564 mm	0,18
	864 mm	0,27
	1164 mm	0,35

Forma TD BASIC		
LED's LED's	POTENZA POWER	CODICE CODE
18	1,4 W	ER1198
24	1,9 W	ER1199
42	3,4 W	ER1200
60	4,8 W	ER1201

Forma TD PLUS		
LED's LED's	POTENZA POWER	CODICE CODE
36	2,9 W	ER1202
54	4,3 W	ER1203
90	7,2 W	ER1204
126	10,1 W	ER1205

Forma TD TOP		
LED's LED's	POTENZA POWER	CODICE CODE
72	5,8 W	ER1206
108	8,5 W	ER1207
180	14,4 W	ER1208
252	20,2 W	ER1209

COLORE COLOUR	OTTICA OPTICS
<input type="checkbox"/> C 5000°K	<input type="checkbox"/> 0
<input type="checkbox"/> N 4000°K	
<input type="checkbox"/> W 2700°K	

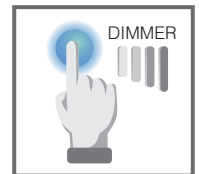

# Forma S

accensione tramite sensore di presenza PIR, spegnimento automatico dopo 30"  
*switching on by means of a PIR detector, switches off automatically after 30"*

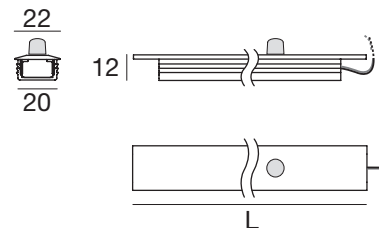

FINITURA FINISH	L. →	kg
	414 mm	0,13
Opaline	564 mm	0,18
	864 mm	0,27
	1164 mm	0,35

Forma S BASIC		
LED's LED's	POTENZA POWER	CODICE CODE
18	1,4 W	ER0388
24	1,9 W	ER0389
42	3,4 W	ER0390
60	4,8 W	ER0391

Forma S PLUS		
LED's LED's	POTENZA POWER	CODICE CODE
36	2,9 W	ER0422
54	4,3 W	ER0423
90	7,2 W	ER0424
126	10,1 W	ER0425

Forma S TOP		
LED's LED's	POTENZA POWER	CODICE CODE
72	5,8 W	ER0393
108	8,6 W	ER0394
180	14,4 W	ER0395
252	20,2 W	ER0396

COLORE COLOUR	OTTICA OPTICS
<input type="checkbox"/> C 5000°K	<input type="checkbox"/> 0
<input type="checkbox"/> N 4000°K	
<input type="checkbox"/> W 2700°K	



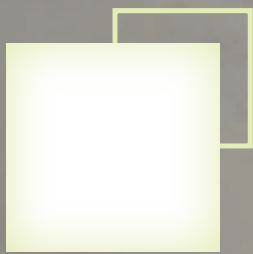

# Firion Info



## Descrizione Description

Profilo in alluminio estruso anodizzato, facile e veloce connessione elettrica, installazione ad incasso in apposita fresata. Sorgente luminosa biemissione con doppio diffusore opalino in policarbonato, ideale per ante senza maniglia.

*Anodized extruded aluminium profile, easy and quick electrical connection, recessed mounting in special groove. Double emission light source with double opal polycarbonate diffuser, ideal for doors without handles.*

## Lunghezze disponibili Available lengths

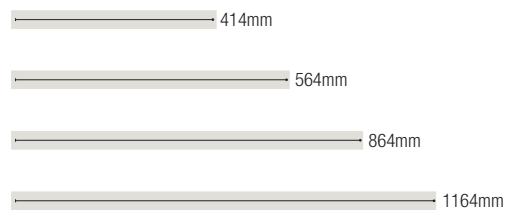

## Potenze LED disponibili Available LED powers

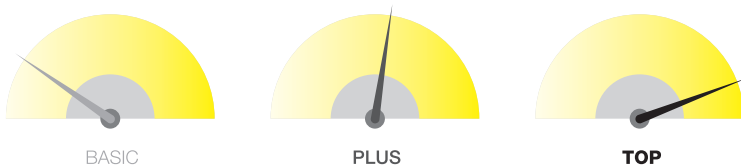

## Scala 1:1 Scale 1:1

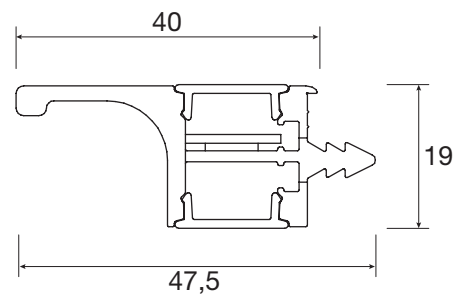

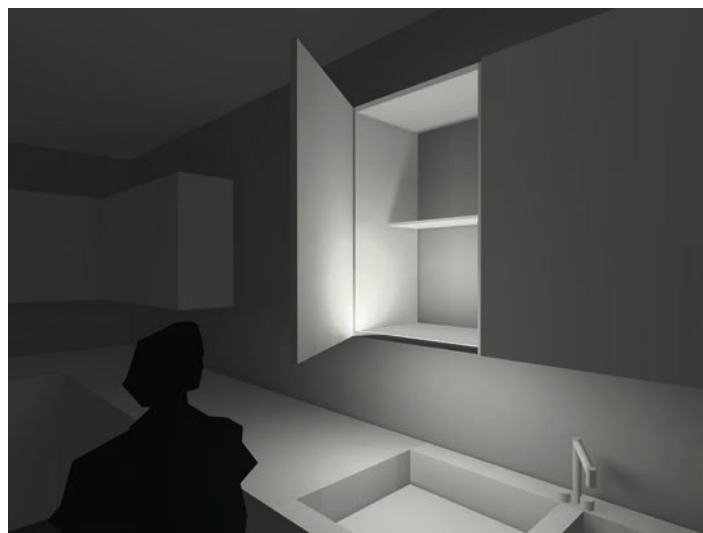
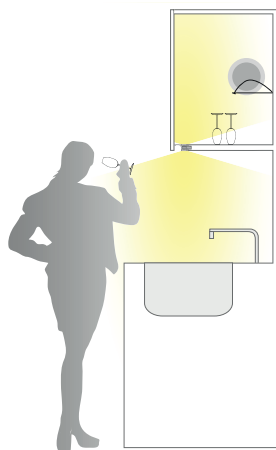
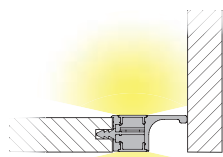

Sistemi di accensione  
Control system

STANDARD  
STANDARD

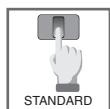

Accensione da prevedere con interruttore a parete o con sistemi remoti (pag 140-141)  
Switching on and off should be provided via wall switch or with remote systems (page 140-141)

INTERRUTTORE MECCANICO  
MECHANICAL SWITCH



B

Accensione/spengimento tramite interruttore meccanico.  
Power on/off by means of a mechanical switch.

SENSORE TOUCH  
TOUCH SENSOR



T

Accensione/spengimento tramite tocco su punto indicato da LED blu.  
Switching on/off is possible by touching the point indicated by the blue LED.

SENSORE TOUCH/DIMMER  
TOUCH/DIMMER SENSOR



TD

Accensione/spengimento e dimerazione tramite tocco su punto indicato da LED blu.  
Switching on/off and dimming is possible by touching the point indicated by the blue LED.

SENSORE DI PROSSIMITÀ  
PROXIMITY SENSOR

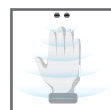

P

Sensore di prossimità, accensione/spengimento tramite mano nei pressi del sensore  
Proximity sensor, switching on/off takes place by passing a hand near the sensor.

Applicazione  
Application

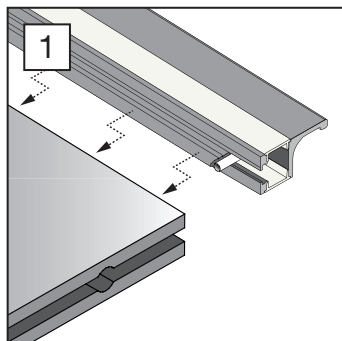

Installazione ad incasso in apposita fresata.

Recessed mounting in special groove.

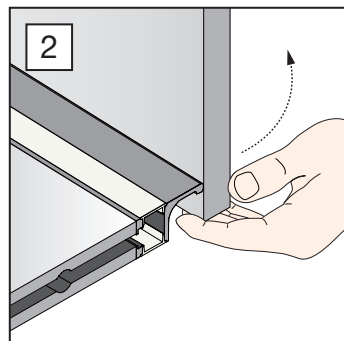

Profilo adatto per ante senza maniglie.

Profile suitable for hinged doors without handles.

Su richiesta  
Upon request

Su richiesta è possibile combinare strip di diverse potenze e colorazioni all'interno dello stesso articolo.

On request, it is possible to combine strips with different power and colour within the same item.

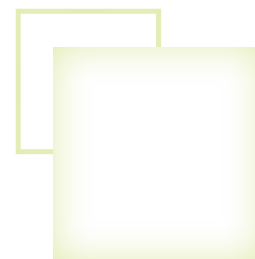



# Firion

versione standard  
standard version

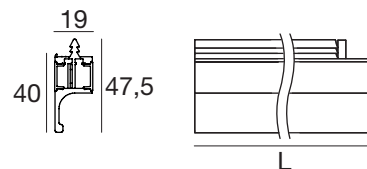

FINITURA FINISH	L.	kg
	414 mm	0,29
Anod. Al.	564 mm	0,38
	864 mm	0,56
	1164 mm	0,74

## Firion BASIC

LED's LED's	POTENZA POWER	CODICE CODE
36	2,9 W	<b>ER0850</b>
60	4,8 W	<b>ER0851</b>
96	7,7 W	<b>ER0852</b>
132	10,6 W	<b>ER0853</b>

## Firion PLUS

LED's LED's	POTENZA POWER	CODICE CODE
84	6,7 W	<b>ER0854</b>
120	9,6 W	<b>ER0855</b>
192	15,4 W	<b>ER0856</b>
264	21,1 W	<b>ER0857</b>

## Firion TOP

LED's LED's	POTENZA POWER	CODICE CODE
168	13,4 W	<b>ER0858</b>
240	19,2 W	<b>ER0859</b>
384	30,7 W	<b>ER0860</b>
528	42,2 W	<b>ER0861</b>

COLORE COLOUR	OTTICA OPTICS
<input type="checkbox"/> C 5000°K	<input type="checkbox"/> 0
<input type="checkbox"/> N 4000°K	
<input type="checkbox"/> W 2700°K	

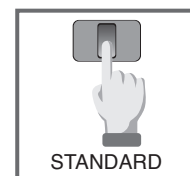

# Firion B

accensione/spengimento tramite interruttore meccanico  
power on/off by means of a mechanical switch



FINITURA FINISH	L.	kg
	414 mm	0,30
Anod. Al.	564 mm	0,39
	864 mm	0,57
	1164 mm	0,75

## Firion B BASIC

LED's LED's	POTENZA POWER	CODICE CODE
36	2,9 W	<b>ER0886</b>
54	4,3 W	<b>ER0887</b>
90	7,2 W	<b>ER0888</b>
126	10,1 W	<b>ER0889</b>

## Firion B PLUS

LED's LED's	POTENZA POWER	CODICE CODE
78	6,2 W	<b>ER0890</b>
114	9,1 W	<b>ER0891</b>
186	14,9 W	<b>ER0892</b>
258	20,6 W	<b>ER0893</b>

## Firion B TOP

LED's LED's	POTENZA POWER	CODICE CODE
156	12,5 W	<b>ER0894</b>
228	18,2 W	<b>ER0895</b>
372	29,8 W	<b>ER0896</b>
516	41,3 W	<b>ER0897</b>

COLORE COLOUR	OTTICA OPTICS
<input type="checkbox"/> C 5000°K	<input type="checkbox"/> 0
<input type="checkbox"/> N 4000°K	
<input type="checkbox"/> W 2700°K	



# Firion T

accensione e spegnimento tramite tocco su punto indicato dal LED blu  
switching on/off is possible by touching the point indicated by the blue LED

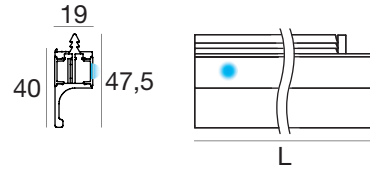

FINITURA FINISH	L. →	kg	Firion T BASIC			Firion T PLUS			Firion T TOP			COLORE COLOUR	OTTICA OPTICS
			LED's LED's	POTENZA POWER	CODICE CODE	LED's LED's	POTENZA POWER	CODICE CODE	LED's LED's	POTENZA POWER	CODICE CODE		
	414 mm	0,30	30	2,4 W	ER0874	72	5,8 W	ER0878	144	11,5 W	ER0882	<input type="checkbox"/> C 5000°K	<input type="checkbox"/> 0
Anod. Al.	564 mm	0,39	54	4,3 W	ER0875	108	8,6 W	ER0879	216	17,9 W	ER0883	<input type="checkbox"/> N 4000°K	
	864 mm	0,57	90	7,2 W	ER0876	180	14,4 W	ER0880	360	28,8 W	ER0884	<input type="checkbox"/> W 2700°K	
	1164 mm	0,75	126	10,1 W	ER0877	252	20,7 W	ER0881	504	40,3 W	ER0885		



# Firion TD

accensione, spegnimento e dimmerazione (da 10% a 100%) tramite tocco su punto indicato dal LED blu  
switching on/off and dimming (from 10% to 100%) is possible by touching the point indicated by the blue LED

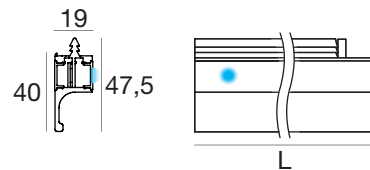

FINITURA FINISH	L. →	kg	Slim TD BASIC			Firion TD PLUS			Firion TD TOP			COLORE COLOUR	OTTICA OPTICS
			LED's LED's	POTENZA POWER	CODICE CODE	LED's LED's	POTENZA POWER	CODICE CODE	LED's LED's	POTENZA POWER	CODICE CODE		
	414 mm	0,30	30	2,4 W	ER1186	72	5,8 W	ER1190	144	11,5 W	ER1194	<input type="checkbox"/> C 5000°K	<input type="checkbox"/> 0
Anod. Al.	564 mm	0,39	54	4,3 W	ER1187	108	8,6 W	ER1191	216	17,9 W	ER1195	<input type="checkbox"/> N 4000°K	
	864 mm	0,57	90	7,2 W	ER1188	180	14,4 W	ER1192	360	28,8 W	ER1196	<input type="checkbox"/> W 2700°K	
	1164 mm	0,75	126	10,1 W	ER1189	252	20,7 W	ER1193	504	40,3 W	ER1197		

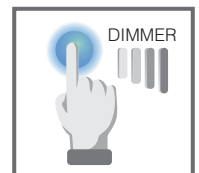

# Firion P

accensione e spegnimento tramite passaggio di una mano nei pressi del sensore (senza contatto)  
switching on and off by passing a hand near the sensor (without contact)

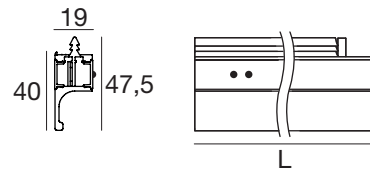

FINITURA FINISH	L.	kg
	414 mm	0,30
Anod. Al.	564 mm	0,39
	864 mm	0,57
	1164 mm	0,75

## Firion P BASIC

LED's LED's	POTENZA POWER	CODICE CODE
30	2,4 W	<b>ER0862</b>
54	4,3 W	<b>ER0863</b>
90	7,2 W	<b>ER0864</b>
126	10,1 W	<b>ER0865</b>

## Firion P PLUS

LED's LED's	POTENZA POWER	CODICE CODE
72	5,8 W	<b>ER0866</b>
108	8,6 W	<b>ER0867</b>
180	14,4 W	<b>ER0868</b>
252	20,7 W	<b>ER0869</b>

## Firion P TOP

LED's LED's	POTENZA POWER	CODICE CODE
144	11,5 W	<b>ER0870</b>
216	17,3 W	<b>ER0871</b>
360	28,8 W	<b>ER0872</b>
504	40,3 W	<b>ER0873</b>

COLORE COLOUR	OTTICA OPTICS
<input type="checkbox"/> C 5000°K	<input type="checkbox"/> 0
<input type="checkbox"/> N 4000°K	
<input type="checkbox"/> W 2700°K	







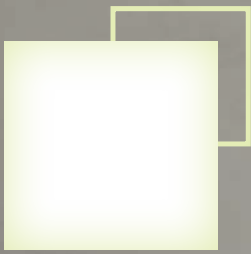

# Shelf Info



## Descrizione Description

Profilo in alluminio estruso anodizzato, facile e veloce connessione elettrica, installazione ad incasso in apposita fresata. Sorgente luminosa biemissione con doppio diffusore opalino in policarbonato. Ideale per essere installato dietro alle mensole o dietro le spalle delle librerie.

*Anodized extruded aluminium profile, easy and quick electrical connection, recessed mounting in special groove, double emission light source with double opal polycarbonate diffuser. Ideal for installation behind shelves or on the back of bookshelves.*

## Potenze LED disponibili Available LED powers

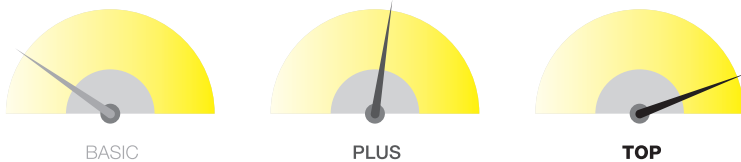

## Lunghezze disponibili Available lengths

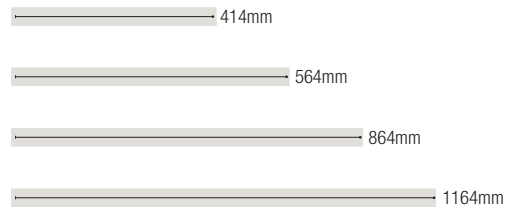

## Scala 1:1 Scale 1:1

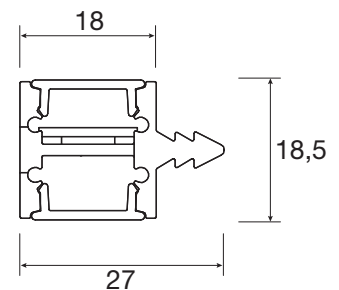

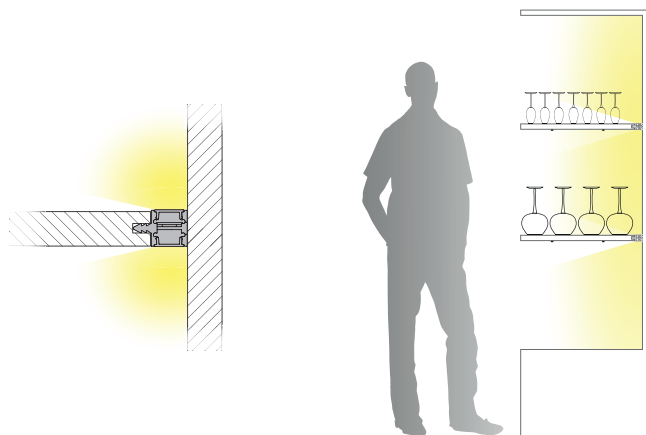

Sistemi di accensione  
Control system

STANDARD  
STANDARD

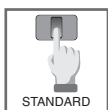

Accensione da prevedere con interruttore a parete o con sistemi remoti (pag 140-141)  
Switching on and off should be provided via wall switch or with remote systems (page 140-141)

Applicazione  
Application

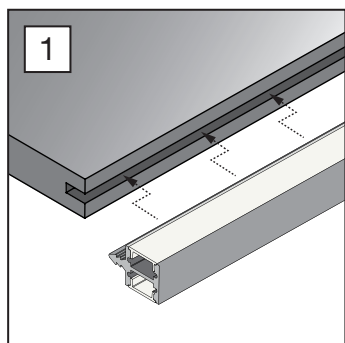

Installazione ad incasso  
in apposita fresata.

*Recessed mounting  
in special groove.*

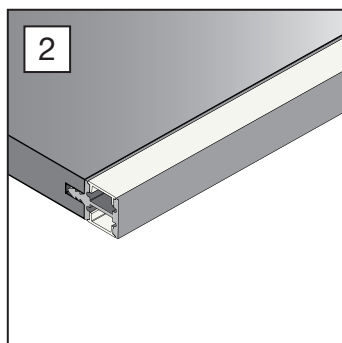

Profilo SHELF fissato alla  
superficie.

*SHELF profile secured to the  
surface.*

Su richiesta  
On request

Su richiesta è possibile combinare strip di diverse  
potenze e colorazioni all'interno dello stesso articolo.

*On request, it is possible to combine strips with different  
power and colour within the same item.*

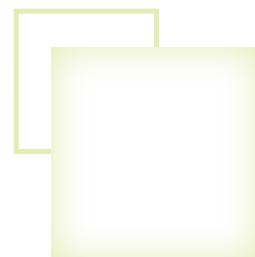

# Shelf

versione standard  
standard version



FINITURA FINISH	L.	kg	Shelf <b>BASIC</b>			Shelf <b>PLUS</b>			Shelf <b>TOP</b>			COLORE COLOUR	OTTICA OPTICS
	→		LED's LED's	POTENZA POWER	CODICE CODE	LED's LED's	POTENZA POWER	CODICE CODE	LED's LED's	POTENZA POWER	CODICE CODE		
	414 mm	0,29	36	2,9 W	<b>ER0651</b>	84	6,7 W	<b>ER0655</b>	168	13,4 W	<b>ER0659</b>	<input type="checkbox"/> C 5000°K	<input type="checkbox"/> 0
Anod. Al.	564 mm	0,38	60	4,8 W	<b>ER0652</b>	120	9,6 W	<b>ER0656</b>	240	19,2 W	<b>ER0660</b>	<input type="checkbox"/> N 4000°K	
	864 mm	0,56	96	7,7 W	<b>ER0653</b>	192	15,4 W	<b>ER0657</b>	384	30,7 W	<b>ER0661</b>	<input type="checkbox"/> W 2700°K	
	1164 mm	0,74	132	10,6 W	<b>ER0654</b>	264	21,1 W	<b>ER0658</b>	528	42,2 W	<b>ER0662</b>		

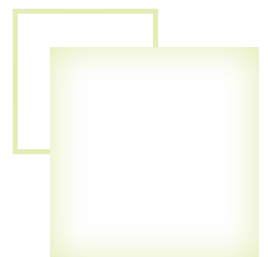
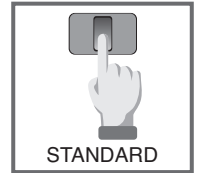













# L-strip Info

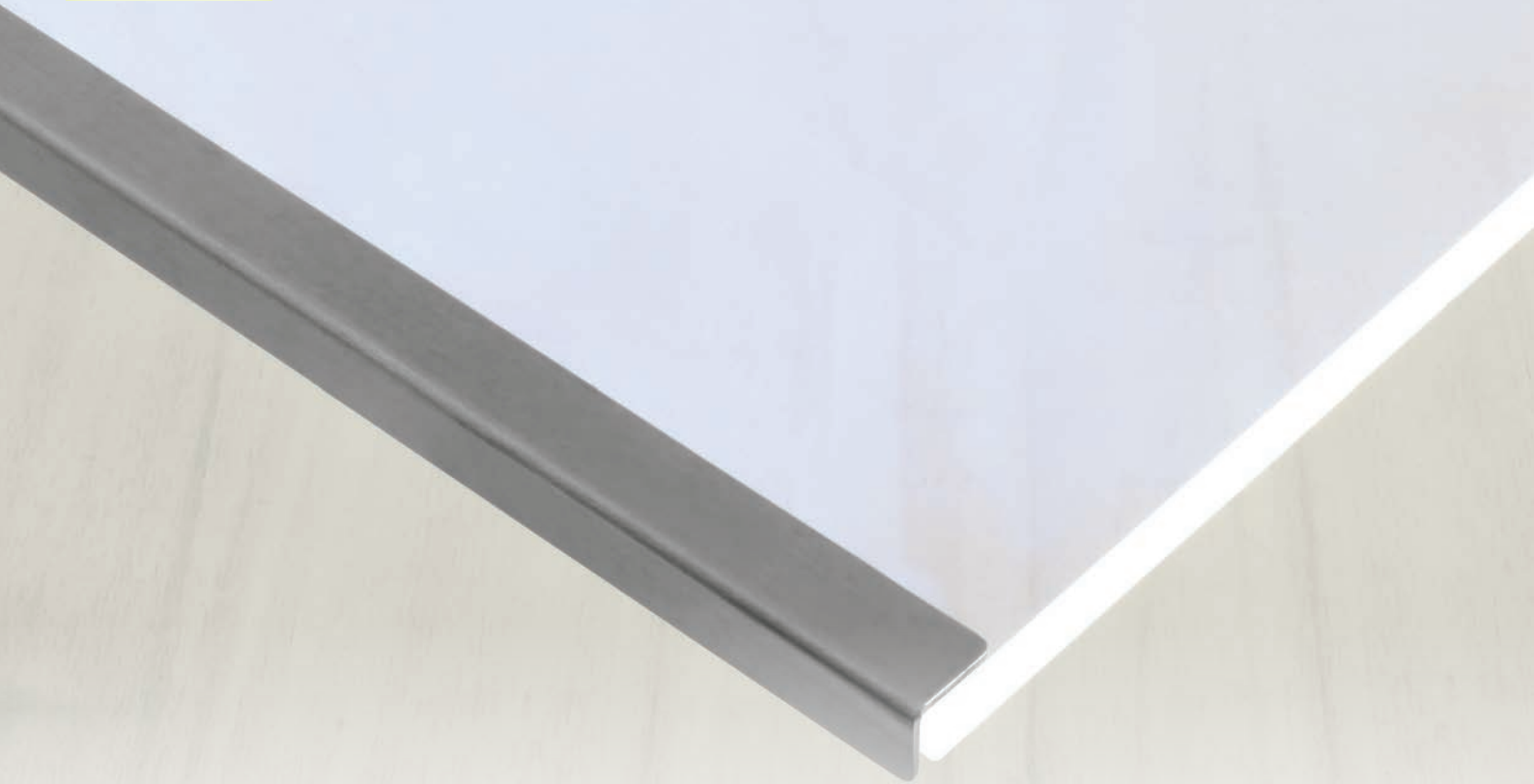

## Descrizione *Description*

Profilo a L in alluminio brillantato, retroilluminazione adatta per ripiani in vetro con spessore 6mm, 8mm e 10mm, installazione rapida tramite banda adesiva. Dimensioni minime: poco invasivo dietro al ripiano in vetro.

*L-shaped profile in polished aluminium, backlight suitable for 6mm, 8mm and 10mm thick glass shelves, quick installation with adhesive strip. Minimum dimensions: minimally invasive behind the glass shelf.*

## Lunghezze disponibili *Available lengths*

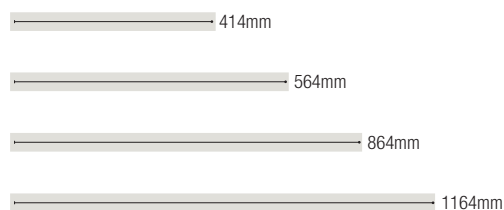

## Potenze LED disponibili *Available LED powers*

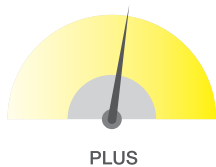

## Scala 1:1 *Scale 1:1*

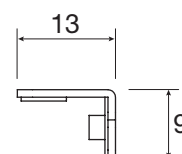

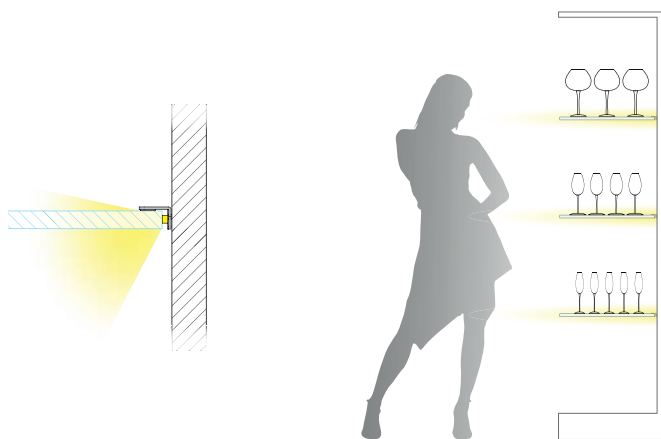

Sistemi di accensione  
Control system

STANDARD  
STANDARD

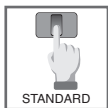

Accensione da prevedere con interruttore a parete o con sistemi remoti (pag 140-141)  
Switching on and off should be provided via wall switch or with remote systems (page 140-141)

Applicazione  
Application

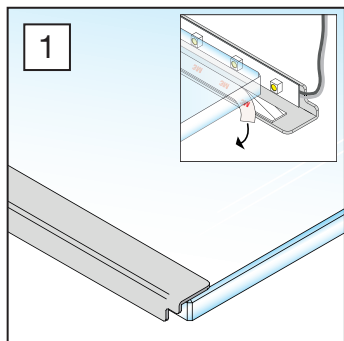

Applicare con fascia adesiva predisposta per il fissaggio del profilo su mensole in vetro.  
Apply with adhesive strip suitable for fastening the profile on glass shelves.

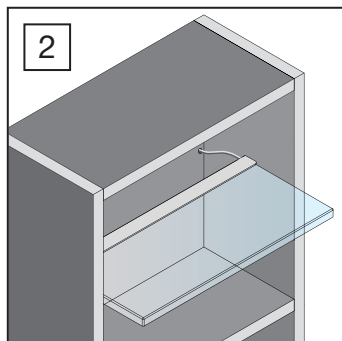

Inserire la mensola in vetro con profilo L-STRIP fissato.  
Insert the glass shelf with the L-STRIP profile attached.

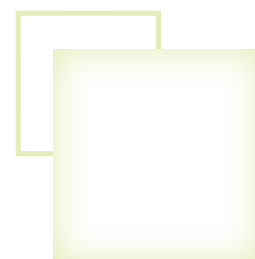



# L-strip

versione standard  
standard version

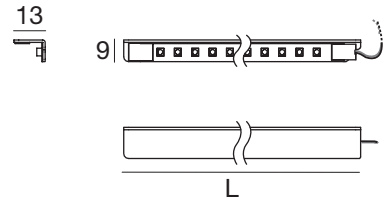

FINITURA FINISH		L.	kg	Lime PLUS			COLORE COLOUR		OTTICA OPTICS
		→		LED's LED's	POTENZA POWER	CODICE CODE			
		414 mm	0,08	48	3,8 W	<b>ER0102</b>	<input type="checkbox"/> C 5000°K		
Anod. Al.		564 mm	0,09	66	5,3 W	<b>ER0103</b>	<input type="checkbox"/> N 4000°K	<input checked="" type="checkbox"/> 0	
		864 mm	0,11	102	8,2 W	<b>ER0104</b>	<input type="checkbox"/> W 3000°K		
		1164 mm	0,13	138	11 W	<b>ER0105</b>			

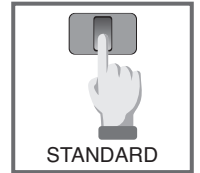



# X-fon Info



## Descrizione Description

Plafoniera con batteria al litio, ricaricabile via porta USB, disponibile con sensore di presenza o di prossimità. Corpo in ABS nero antracite o bianco, copertura in policarbonato opalino. Facile e comoda installazione tramite fissaggio magnetico.

*Ceiling lamp with rechargeable lithium battery, available with presence detector or proximity sensor. Black anthracite or white ABS body, opal polycarbonate cover. Easy and convenient installation using magnetic fixing.*

## Potenze LED disponibili Available LED powers

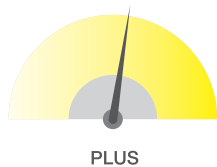

## Lunghezze disponibili Available lengths

130mm

## Scala 1:1 Scale 1:1

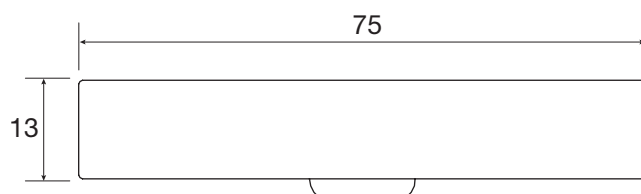

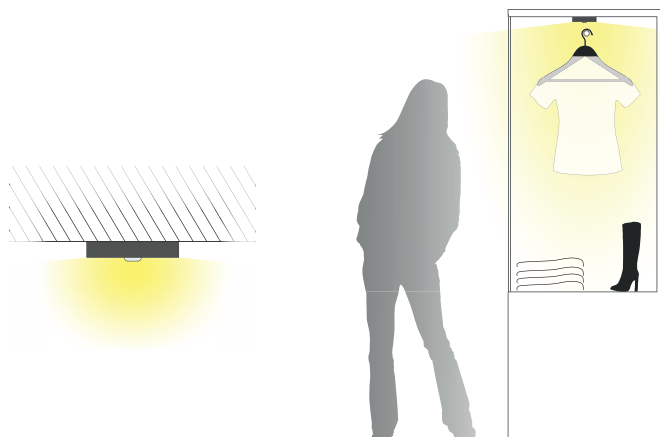

Sistemi di accensione  
Control system

**SENSORE DI PROSSIMITÀ**  
PROXIMITY SENSOR



P

Sensore di prossimità, accensione e spegnimento tramite mano nei pressi del sensore.  
*Proximity sensor, switching on/off takes place passing a hand near the sensor.*

**SENSORE PIR**  
PIR SENSOR



S

Accensione tramite rilevamento, spegnimento automatico dopo 30" di mancato rilevamento.  
*Switching on by detection, switches off automatically after 30" seconds of no detection.*

Applicazione  
Application

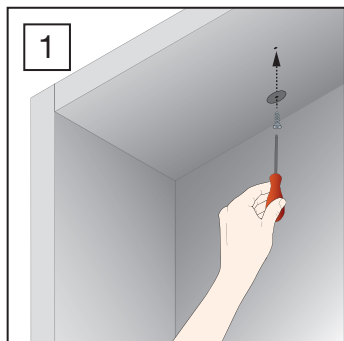

1  
Avvitare l'apposito magnete per il fissaggio dell'articolo alla superficie.

*Screw the special magnet for securing the item to the surface.*

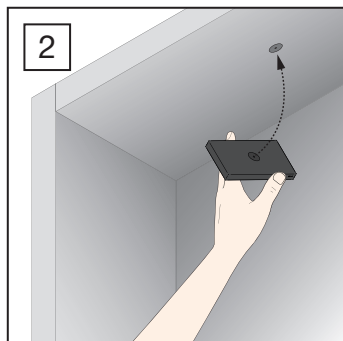

2  
Attaccare l'articolo X-FON al magnete precedentemente fissato.

*Attach the X-FON to the previously attached magnet*

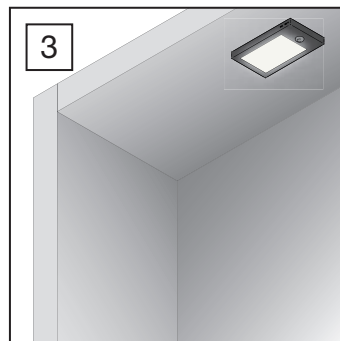

3  
Articolo X-FON installato alla superficie mediante magnete.

*X-FON installed on the surface using magnet.*

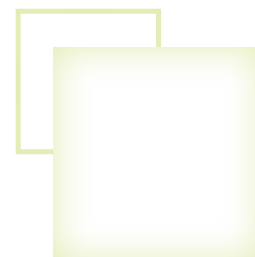



# X-fon P

accensione e spegnimento tramite passaggio di una mano nei pressi del sensore (senza contatto)  
*power on and off by moving a hand close to the sensor (without touch)*

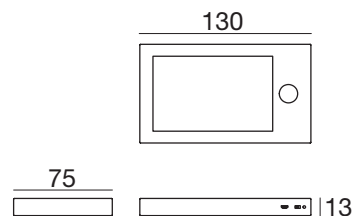

FINITURA FINISH		X-fon P		COLORE COLOUR		OTTICA OPTICS	
	kg	LED's LED's	POTENZA POWER	CODICE CODE			
White	0,15	19	1,8 W ??mA	ER1220	<input type="checkbox"/> N 4000°K	<input checked="" type="checkbox"/> 0	
Anthracite				ER1221	<input type="checkbox"/> W 3000°K		

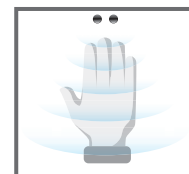

# X-fon S

accensione tramite sensore di presenza PIR, spegnimento automatico dopo 30"  
*power on through PIR presence detector, automatic switching off after 30"*

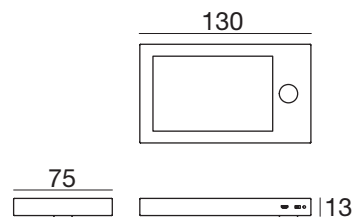

FINITURA FINISH		X-fon S		COLORE COLOUR		OTTICA OPTICS	
	kg	LED's LED's	POTENZA POWER	CODICE CODE			
White	0,15	19	1,8 W	ER1218	<input type="checkbox"/> N 4000°K	<input checked="" type="checkbox"/> 0	
Anthracite				ER1219	<input type="checkbox"/> W 3000°K		







# I-fon Info



## Descrizione *Description*

Corpo in policarbonato opale, installazione ad incasso o a plafone con apposito accessorio. Design innovativo, dimensioni ridotte, facile connessione tramite attacchi rapidi.

*Opal polycarbonate body, recessed or surface installation with specific accessory. Innovative design, reduced dimensions, easy connection using quick connectors.*

## Lunghezze disponibili *Available lengths*

 160mm

## Potenze LED disponibili *Available LED powers*

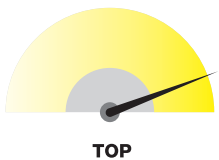

## Scala 1:1 *Scale 1:1*

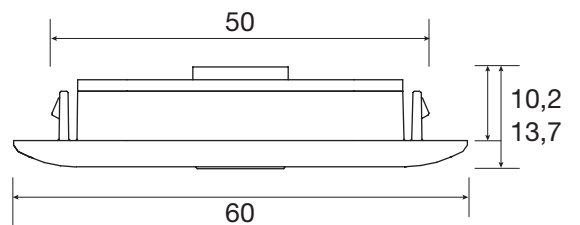

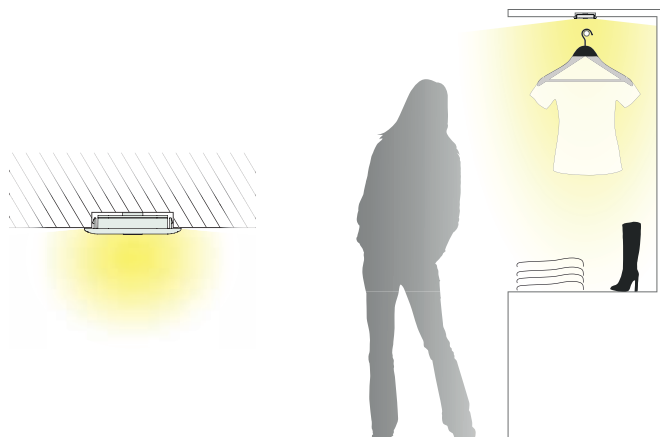

Sistemi di accensione  
Control system

STANDARD  
STANDARD

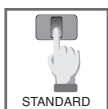

Accensione da prevedere con interruttore a parete o con sistemi remoti (pag 140-141)  
*Switching on and off should be provided via wall switch or with remote systems (page 140-141)*

SENSORE PIR  
PIR SENSOR



Accensione tramite rilevamento, spegnimento automatico dopo 30" di mancato rilevamento.  
*Switching on by detection, switches off automatically after 30" seconds of no detection.*

SENSORE TOUCH  
TOUCH SENSOR



Accensione/spegnimento tramite tocco su punto indicato da LED blu.  
*Switching on/off is possible by touching the point indicated by the blue LED.*

Applicazione  
Application

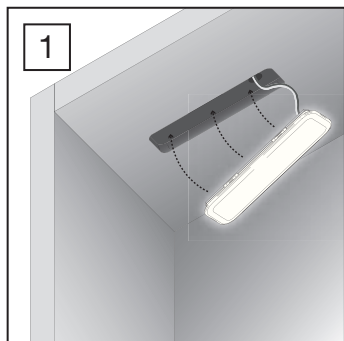

L'articolo I-FON viene fissato ad incasso senza l'uso di viti.  
*I-FON is mounted recessed without using screws.*

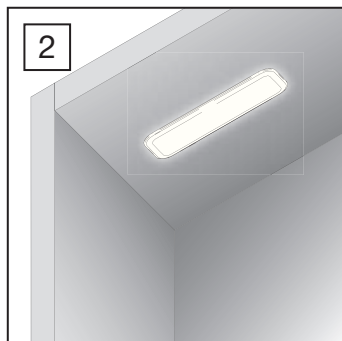

Installazione direttamente su apposita fresata nel legno.  
*Installation directly on a special groove in the wood.*

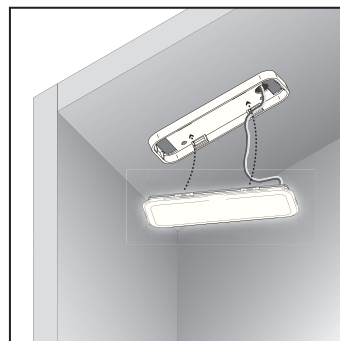

Possibilità di installare I-FON a plafone mediante apposito accessorio "mascherina dima".  
*I-FON can be surface installed using the specific "mask template" accessory.*

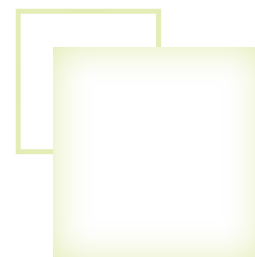



# I-fon

versione standard  
standard version

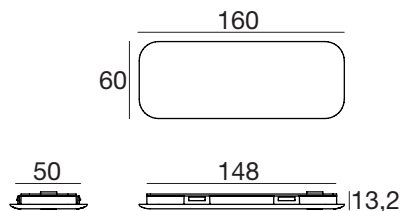

FINITURA FINISH		I-fon <b>TOP</b>			COLORE COLOUR		OTTICA OPTIC	
	kg	LED's LED's	POTENZA POWER	CODICE CODE				
Opaline	0,13	96	8,5 W	<b>ER1213</b>	<b>C</b> 5000°K	<b>N</b> 4000°K	<b>W</b> 3000°K	<b>0</b>

## Accessories

FINITURA FINISH	CODICE CODE
<b>BI</b>	<b>ERA072</b>



Mascherina per fissaggio a plafone e viti autofilettanti, verniciabile a richiesta  
Template for surface mounting and self-tapping screws, can be painted on request.

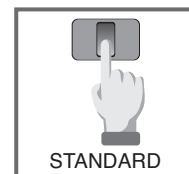

# I-fon T

accensione e spegnimento tramite tocco su punto indicato dal LED blu  
switching on/off is possible by touching the point indicated by the blue LED

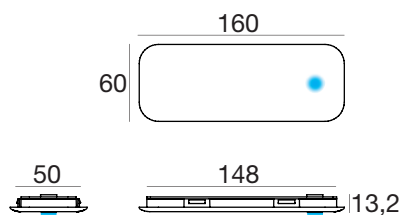

FINITURA FINISH		I-fon T <b>TOP</b>			COLORE COLOUR		OTTICA OPTIC	
	kg	LED's LED's	POTENZA POWER	CODICE CODE				
Opaline	0,13	96	8,5 W	<b>ER1000</b>	<b>C</b> 5000°K	<b>N</b> 4000°K	<b>W</b> 3000°K	<b>0</b>

## Accessories

FINITURA FINISH	CODICE CODE
<b>BI</b>	<b>ERA072</b>



Mascherina per fissaggio a plafone e viti autofilettanti, verniciabile a richiesta.  
Template for surface mounting and self-tapping screws, can be painted on request.



# I-fon S

accensione tramite sensore di presenza PIR, spegnimento automatico dopo 30"  
switching on by means of a PIR detector, switches off automatically after 30"

CV CE

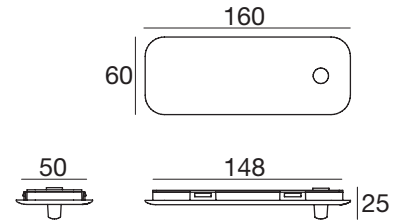

FINITURA  
FINISH



Opaline 0,13

## I-fon S TOP

LED's LED's	POTENZA POWER	CODICE CODE
96	8,5 W	<b>ER0999</b>

COLORE  
COLOUR

C  
5000°K  
 N  
4000°K  
 W  
3000°K

OTTICA  
OPTIC



## Accessories

FINITURA  
FINISH

BI

ERA072



Mascherina per fissaggio a  
plafone e viti autofilettanti,  
verniciabile a richiesta  
Template for surface mount-  
ing and self-tapping screws,  
can be painted on request.



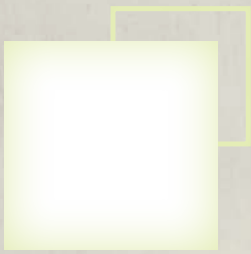

# Moon Info



## Descrizione Description

Profilo asimmetrico in alluminio estruso anodizzato, installazione ad incasso, alimentazione remota con driver a tensione costante. Facile connessione mediante cavo con attacco rapido, luce direzionata antiabbagliante, ideale per scompartimenti degli armadi e pensili della cucina.

*Asymmetric anodized extruded aluminium profile, recessed installation, remote power supply with constant-voltage driver. Easy electrical connection using cable with quick connectors, anti-glare directed light, ideal for wardrobe compartments and kitchen cabinets.*

## Potenze LED disponibili Available LED powers

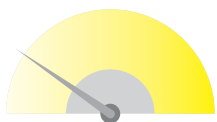

BASIC



PLUS



TOP

## Lunghezze disponibili Available lengths

414mm

564mm

864mm

1164mm

## Scala 1:1 Scale 1:1

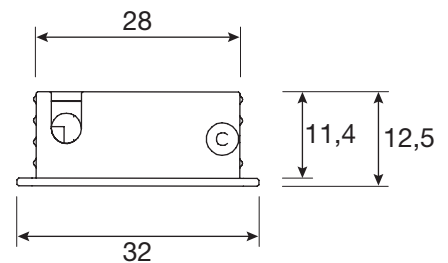

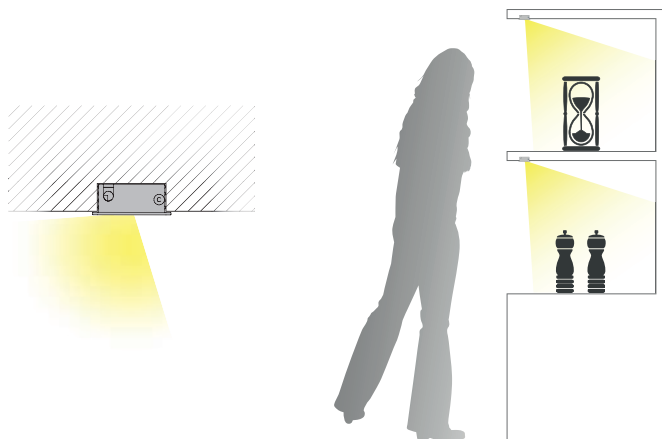

Sistemi di accensione  
Control system

STANDARD  
STANDARD

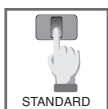

Accensione da prevedere con interruttore a parete o con sistemi remoti (pag 140-141)  
*Switching on and off should be provided via wall switch or with remote systems (page 140-141)*

SENSORE PIR  
PIR SENSOR



Accensione tramite rilevamento, spegnimento automatico dopo 30" di mancato rilevamento.  
*Power on by detection, switches off automatically after 30" of no detection.*

Applicazione  
Application

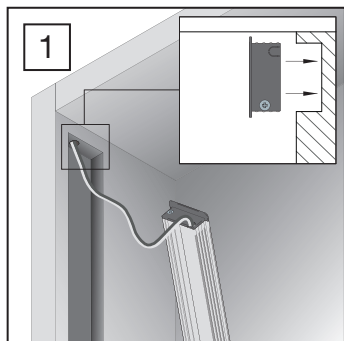

Fissaggio ad incasso senza l'uso di viti.

*Recessed installation without using screws.*

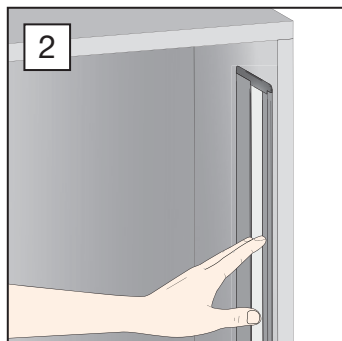

Installazione direttamente su apposita fresata nel legno.

*Installation directly on a special groove in the wood.*

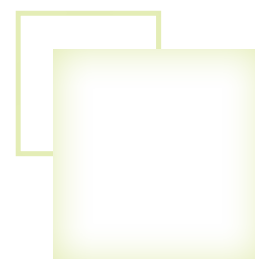



# Moon

versione standard  
standard version

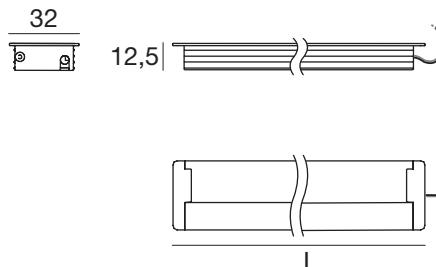

FINITURA FINISH	L.	kg
	414 mm	0,17
Anod. Al.	564 mm	0,21
	864 mm	0,30
	1164 mm	0,38

## Moon BASIC

LED's LED's	POTENZA POWER	CODICE CODE
18	1,4 W	<b>ER1048</b>
30	2,4 W	<b>ER1049</b>
48	3,8 W	<b>ER1050</b>
66	5,3 W	<b>ER1051</b>

## Moon PLUS

LED's LED's	POTENZA POWER	CODICE CODE
42	3,4 W	<b>ER1052</b>
60	4,8 W	<b>ER1053</b>
96	7,7 W	<b>ER1054</b>
132	10,6 W	<b>ER1055</b>

## Moon TOP

LED's LED's	POTENZA POWER	CODICE CODE
84	6,7 W	<b>ER1056</b>
120	9,6 W	<b>ER1057</b>
192	15,4 W	<b>ER1058</b>
264	21,1 W	<b>ER1059</b>

COLORE COLOUR	OTTICA OPTICS
<input type="checkbox"/> C 5000°K	<input type="checkbox"/> 0
<input type="checkbox"/> N 4000°K	
<input type="checkbox"/> W 2700°K	

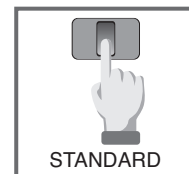

# Moon S

accensione tramite sensore di presenza PIR disponibile posizionato a Sx o a Dx, spegnimento automatico dopo 30"  
switching on by means of a PIR detector placed on the left or right side, switches off automatically after 30"

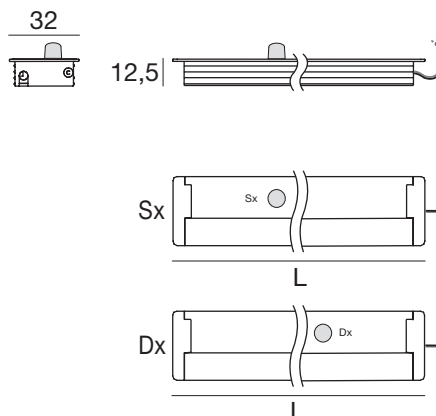

FINITURA FINISH	L.	kg
	414 mm	0,18
Anod. Al.	564 mm	0,22
	864 mm	0,31
	1164 mm	0,39

## Moon S BASIC

LED's LED's	POTENZA POWER	CODICE SX SX CODE	CODICE DX DX CODE
18	1,4 W	<b>ER1060</b>	<b>ER1072</b>
24	1,9 W	<b>ER1061</b>	<b>ER1073</b>
42	3,4 W	<b>ER1062</b>	<b>ER1074</b>
60	4,8 W	<b>ER1063</b>	<b>ER1075</b>

## Moon S PLUS

LED's LED's	POTENZA POWER	CODICE SX SX CODE	CODICE DX DX CODE
36	2,9 W	<b>ER1064</b>	<b>ER1076</b>
54	4,3 W	<b>ER1065</b>	<b>ER1077</b>
90	7,2 W	<b>ER1066</b>	<b>ER1078</b>
126	10,1 W	<b>ER1067</b>	<b>ER1079</b>

## Moon S TOP

LED's LED's	POTENZA POWER	CODICE SX SX CODE	CODICE DX DX CODE
72	5,8 W	<b>ER1068</b>	<b>ER1080</b>
108	8,6 W	<b>ER1069</b>	<b>ER1081</b>
180	14,4 W	<b>ER1070</b>	<b>ER1082</b>
252	20,2 W	<b>ER1071</b>	<b>ER1083</b>

COLORE COLOUR	OTTICA OPTICS
<input type="checkbox"/> C 5000°K	<input type="checkbox"/> 0
<input type="checkbox"/> N 4000°K	
<input type="checkbox"/> W 2700°K	







# RECESSED SPOTLIGHT

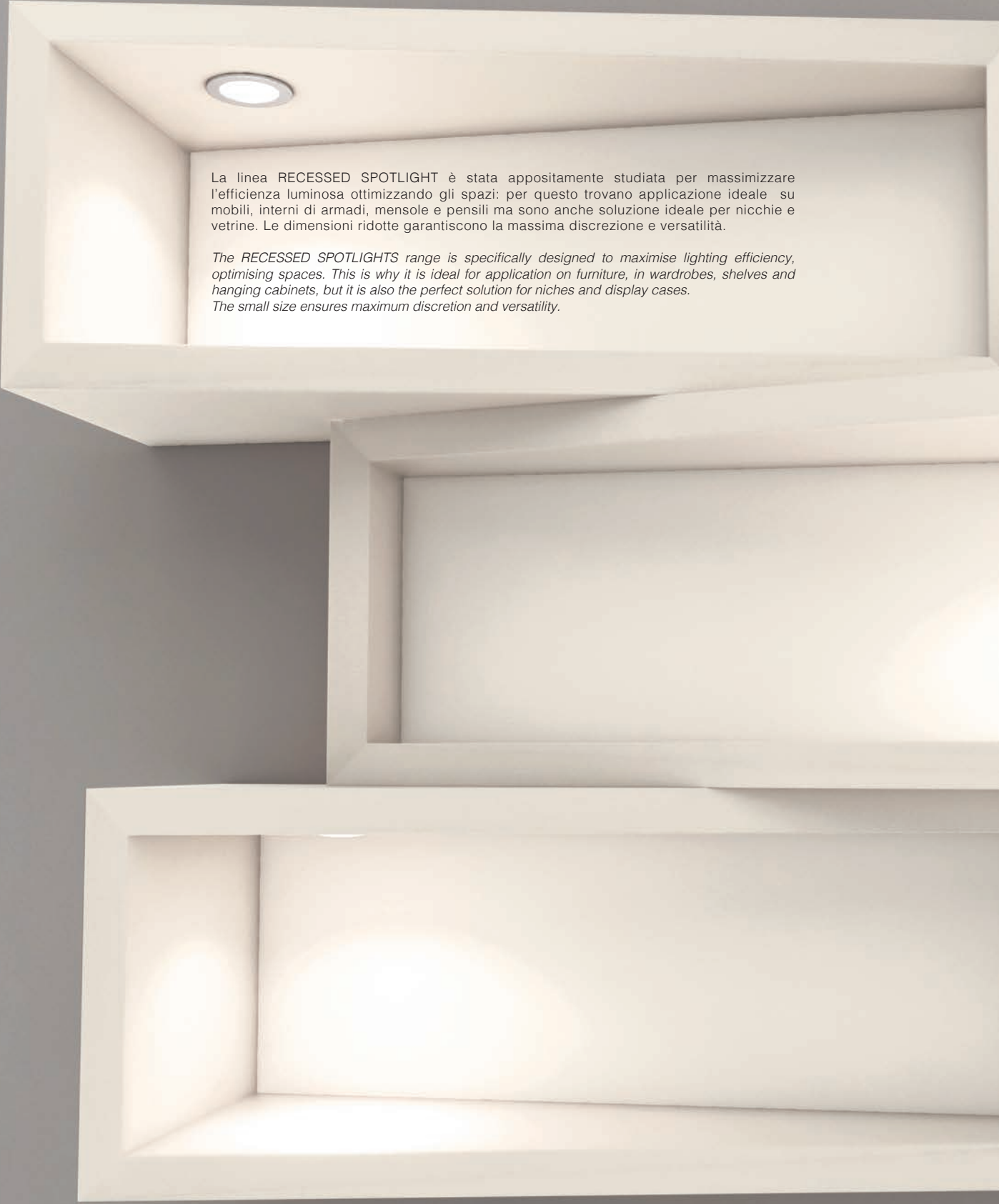

La linea RECESSED SPOTLIGHT è stata appositamente studiata per massimizzare l'efficienza luminosa ottimizzando gli spazi: per questo trovano applicazione ideale su mobili, interni di armadi, mensole e pensili ma sono anche soluzione ideale per nicchie e vetrine. Le dimensioni ridotte garantiscono la massima discrezione e versatilità.

*The RECESSED SPOTLIGHTS range is specifically designed to maximise lighting efficiency, optimising spaces. This is why it is ideal for application on furniture, in wardrobes, shelves and hanging cabinets, but it is also the perfect solution for niches and display cases. The small size ensures maximum discretion and versatility.*



Cal page 114



Sem page 115

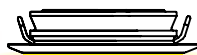

Sem SMALL page 115

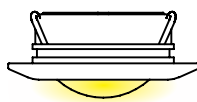

Isy page 116

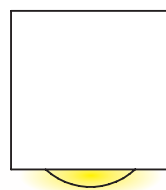

Isy SURFACE page 116

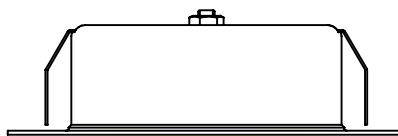

Lyn page 117

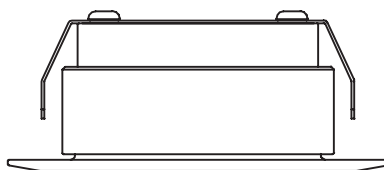

Teo page 117

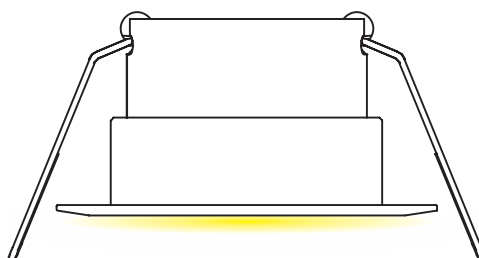

Alex page 118



# Cal



Faretto ad incasso in ottone cromato con lente in PMMA trasparente. Installazione ad incasso tramite molla, dimensioni ridotte di appena 14 mm Ø. Facile connessione tramite cavo con attacco rapido.

*Recessed spotlight in chromium-plated brass body with transparent PMMA lens. recessed installation using spring, reduced size of just 14 mm Ø. Easy connection using cable with quick connector.*



## Cal

FINITURA FINISH	kg	LED's LED's	POTENZA POWER	CODICE CODE
Chrome	0,07	1	1 W 350mA	ER0995

COLORE COLOUR	OTTICA OPTICS
<input type="checkbox"/> C 6000°K	▲ 2
<input type="checkbox"/> N 4000°K	
<input type="checkbox"/> W 3000°K	



# Sem



Corpo in ottone, installazione ad incasso su superfici sottili (min. 7 mm). LED ad alta efficienza fino a 120 lm/W, percezione reale dei colori (CRI > 80), 50.000 ore di durata.

Brass body, recessed installation on thin surfaces (min. 8 mm). High efficiency LED up to 120 lm/W, true colour perception (CRI > 80), 50,000 hours of life.



6,5 l = 1,5      6,5 l = 1,5

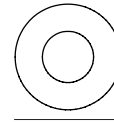

Ø50

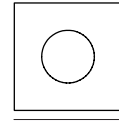

□50



Ø41

## Sem ROUND

FINITURA FINISH	kg	LED's LED's	POTENZA POWER	CODICE CODE
Chrome	0,05	1	0,7 W 220mA	ER0046
Nickel				ER0047

## Sem SQUARED

kg	LED's LED's	POTENZA POWER	CODICE CODE
0,06	1	0,7 W 220mA	ER0048
			ER0049

COLORE COLOUR	OTTICA OPTICS
C 6000°K	
N 4000°K	0
W 3000°K	

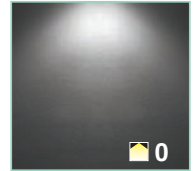

# Sem SMALL



Corpo in ottone, Installazione ad incasso su superfici sottili (min. 7 mm). LED ad alta efficienza fino a 120 lm/W, percezione reale dei colori (CRI > 80), 50.000 ore di durata.

Brass body, recessed installation on thin surfaces (min. 8 mm). High efficiency LED up to 120 lm/W, true colour perception (CRI > 80), 50,000 hours of life.



6,5 l = 1,5      6,5 l = 1,5



Ø35



□35



Ø30

## Sem SMALL ROUND

FINITURA FINISH	kg	LED's LED's	POTENZA POWER	CODICE CODE
Chrome	0,04	1	0,7 W 220mA	ER0042
Nickel				ER0043

## Sem SMALL SQUARED

kg	LED's LED's	POTENZA POWER	CODICE CODE
0,05	1	0,7 W 220mA	ER0044
			ER0045

COLORE COLOUR	OTTICA OPTICS
C 6000°K	
N 4000°K	0
W 3000°K	

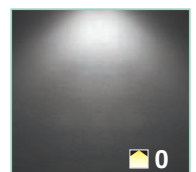

# Isy



Corpo in ottone, Installazione ad incasso disponibile con ottica diffusa o conica. LED ad alta efficienza fino a 120 lm/W, percezione reale dei colori (CRI > 80), 50.000 ore di durata.

Brass body, recessed installation available with diffused or conical optics. High efficiency LED up to 120 lm/W, true colour perception (CRI > 80), 50,000 hours of life.

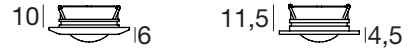

Isy ROUND ©			
FINITURA FINISH	kg	LED's LED's	POTENZA POWER
Chrome			
	0,04	1	1 W 350mA
Nickel			
			<b>ER0214</b>
			<b>ER0215</b>

Isy SQUARED □			
FINITURA FINISH	kg	LED's LED's	POTENZA POWER
Chrome			
	0,05	1	1 W 350mA
Nickel			
			<b>ER0219</b>
			<b>ER0220</b>

COLORE COLOUR	OTTICA OPTICS
<input type="checkbox"/> C 6000°K	<input type="checkbox"/> 0
<input type="checkbox"/> N 4000°K	<input checked="" type="checkbox"/> 2
<input type="checkbox"/> W 3000°K	

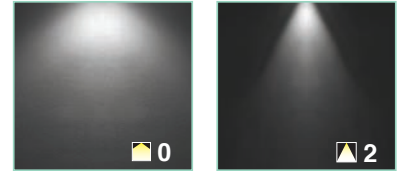

# Isy SURFACE



Corpo in ottone, Installazione a ridosso disponibile con ottica diffusa o conica. LED ad alta efficienza fino a 120 lm/W, percezione reale dei colori (CRI > 80), 50.000 ore di durata.

Brass body, close surface installation available with diffused or conical optics. High efficiency LED up to 120 lm/W, true colour perception (CRI > 80), 50,000 hours of life.

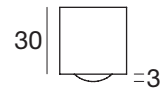
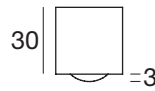

Isy SURFACE ROUND ©			
FINITURA FINISH	kg	LED's LED's	POTENZA POWER
Chrome			
	0,16	1	1 W 350mA
Nickel			
			<b>ER0228</b>
			<b>ER0229</b>

Isy SURFACE SQUARED □			
FINITURA FINISH	kg	LED's LED's	POTENZA POWER
Chrome			
	0,05	1	1 W 350mA
Nickel			
			<b>ER0230</b>
			<b>ER0231</b>

COLORE COLOUR	OTTICA OPTICS
<input type="checkbox"/> C 6000°K	<input type="checkbox"/> 0
<input type="checkbox"/> N 4000°K	<input checked="" type="checkbox"/> 2
<input type="checkbox"/> W 3000°K	

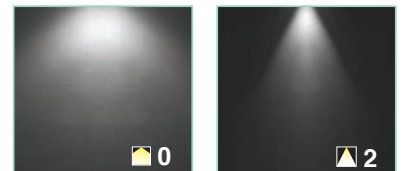

# Lyn



Corpo in alluminio, installazione ad incasso con molla. LED ad alta efficienza fino a 120 lm/W, percezione reale dei colori (CRI > 80), 50.000 ore di durata.

*Recessed spot, aluminium body. Recessed installation with spring, High efficiency LED up to 120 lm/W, true colour perception (CRI > 80), 50,000 hours of life.*

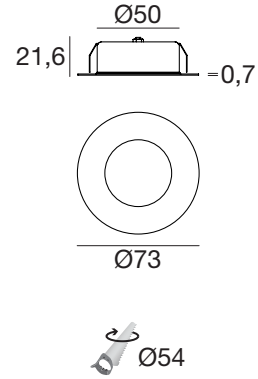

## Lyn

FINITURA FINISH	kg	LED's LED's	POTENZA POWER	CODICE CODE	COLORE COLOUR	OTTICA OPTICS
White				ER0056	C 6000°K	
Black	0,76	3	3 W 350mA	ER0057	N 4000°K	0
Chrome				ER0054	W 3000°K	

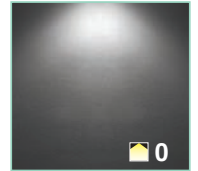

# Teo



Corpo in alluminio, installazione ad incasso con molla. LED ad alta efficienza fino a 120 lm/W, percezione reale dei colori (CRI > 80), 50.000 ore di durata.

*Recessed spot, aluminium body. Recessed installation with spring, High efficiency LED up to 120 lm/W, true colour perception (CRI > 80), 50,000 hours of life.*

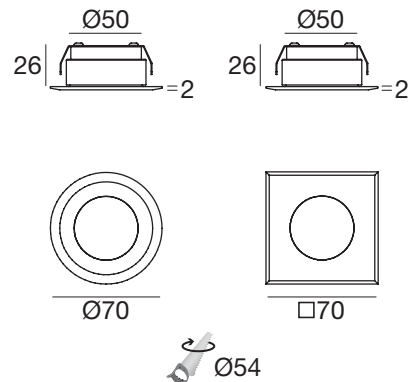

Teo ROUND					Teo SQUARED					COLORE COLOUR		OTTICA OPTICS	
FINITURA FINISH	kg	LED's LED's	POTENZA POWER	CODICE CODE	kg	LED's LED's	POTENZA POWER	CODICE CODE	COLORE COLOUR	OTTICA OPTICS			
White				ER0241				ER0245	C 6000°K				
Black				ER0242				ER0246	N 4000°K	0			
Chrome	0,17	3	3 W 350mA	ER0239	0,19	3	3 W 350mA	ER0243	W 3000°K				
Nickel				ER0240				ER0244					

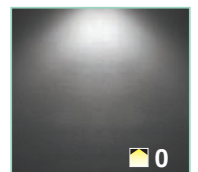



# Alex



Corpo in alluminio, installazione ad incasso con molla. LED ad alta efficienza fino a 120 lm/W, percezione reale dei colori (CRI > 80), 50.000 ore di durata.

*Recessed spot, aluminium body. Recessed installation with spring, High efficiency LED up to 120 lm/W, true colour perception (CRI > 80), 50,000 hours of life.*

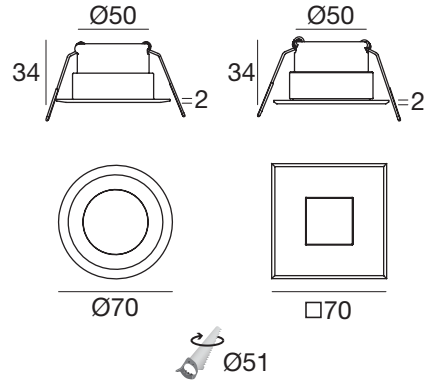

## Alex

FINITURA FINISH	kg	LED's LED's	POTENZA POWER	CODICE CODE	CODICE CODE	COLORE COLOUR	OTTICA OPTICS
White				ER0974	ER0978	C 6000°K	
Black	0,18	3	3 W 350mA	ER0975	ER0979	N 4000°K	0
Chrome				ER0976	ER0980	W 3000°K	
Nickel				ER0977	ER0981		

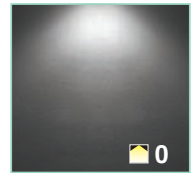

# Alex POWER



Corpo in alluminio, installazione ad incasso con molla. LED ad alta efficienza fino a 120 lm/W, percezione reale dei colori (CRI > 80), 50.000 ore di durata.

*Recessed spot, aluminium body. Recessed installation with spring, High efficiency LED up to 120 lm/W, true colour perception (CRI > 80), 50,000 hours of life.*

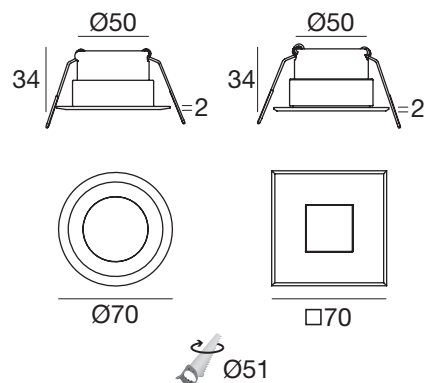

## Alex POWER

FINITURA FINISH	kg	LED's LED's	POTENZA POWER	CODICE CODE	CODICE CODE	COLORE COLOUR	OTTICA OPTICS
White				ER1012	ER1016	C 6000°K	
Black	0,18	3	6 W 630mA	ER1013	ER1017	N 4000°K	0
Chrome				ER1014	ER1018	W 3000°K	
Nickel				ER1015	ER1019		

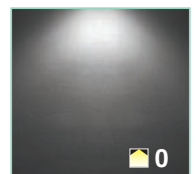







# STRIPILED CIRCUITS

I circuiti STRIPILED stampati permettono di creare linee di luce continue, grazie alla banda adesiva presente sul dorso o all'apposito kit, il fissaggio risulta semplice anche negli spazi più ristretti. Disponibili nelle versioni monocromatiche Basic, Plus, Hi-Flux e Top; la versione RGB permette di creare effetti di luce policromatici. Su richiesta disponibili altre gradazioni Kelvin, versioni monocolori (verde, blu, rosso e ambra) e alta resa cromatica CRI>90

*STRIPILED circuits allow the creation of continuous light lines and, thanks to the adhesive tape on the back or to the specific kit, they are easy to mount even in the tightest spaces. They are available in the monochromatic versions Basic, Plus, Hi-Flux and Top. With the appropriate control system, the RGB version allows the creation of polychromatic light effects. On request, other Kelvin grades, monochrome versions (green, blue, red and amber) and high colour rendering CRI>90 are available*





Ribbon page 122



Dropper page 122



Crystal page 123



Flex page 123



RGB page 124

Consigliamo l'applicazione su profili in alluminio per garantire una corretta dissipazione termica. Visualizza pagine STRIP PROFILES.

*We recommend application on aluminium profiles to guarantee correct heat dissipation. See STRIP PROFILES pages.*



# Ribbon



Strip LED flessibile, installazione rapida tramite banda adesiva, taglio su misura. Personalizzazione eseguibile dal cliente, 30.000 ore di durata CRI>80.

*Flexible LED strip, quick connection with adhesive strip, custom cut. Self-customizable, 30,000 hours of life CRI>80.*

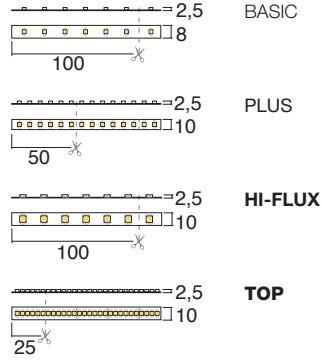

## Ribbon

VERSIONE VERSION	LED's/m LED's/m	POTENZA POWER	CODICE CODE	COLORE COLOUR	OTTICA OPTICS
BASIC	60	4,8 W	ERS001	<input type="checkbox"/> C 5000°K	<input type="checkbox"/> 0
PLUS	120	9,6 W	ERS007	<input type="checkbox"/> N 4000°K	
HI-FLUX	60	14,4 W	ERS004	<input type="checkbox"/> W 2700°K	
TOP	240	19,2 W	ERS008		



# Dropper



Strip LED flessibile, installazione rapida tramite banda adesiva, taglio su misura. Copertura curva in silicone, 30.000 ore di durata CRI>80.

*Flexible LED strip, quick connection with adhesive strip, custom cut. Curved silicone cover, 30,000 hours of life CRI>80.*

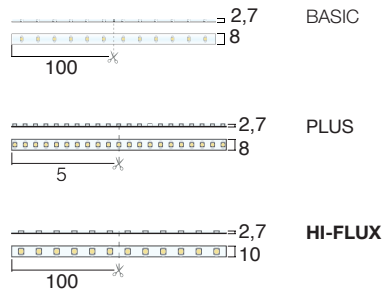

## Dropper

VERSIONE VERSION	LED's/m LED's/m	POTENZA POWER	CODICE CODE	COLORE COLOUR	OTTICA OPTICS
BASIC	60	4,8 W	ERS002	<input type="checkbox"/> C 5000°K	<input type="checkbox"/> 0
PLUS	120	9,6 W	ERS010	<input type="checkbox"/> N 4000°K	
HI-FLUX	60	14,4 W	ERS005	<input type="checkbox"/> W 2700°K	



# Crystal



Strip LED flessibile, copertura in silicone, installazione con kit di fissaggio (incluso). Taglio su misura, 30.000 ore di durata CRI>80.

*Flexible led strip, silicone cover, installation with mounting kit (included). Custom cut, 30,000 hours of life CRI>80.*



## Crystal

VERSIONE VERSION	LED's/m LED's/m	POTENZA POWER	CODICE CODE	COLORE COLOUR	OTTICA OPTICS
BASIC	60	4,8 W	ERS003	<input type="checkbox"/> C 5000°K <input type="checkbox"/> N 4000°K <input type="checkbox"/> W 2700°K	
HI-FLUX	60	14,4 W	ERS006		



# Flex



Strip LED flessibile, copertura in silicone, installazione con kit di fissaggio (incluso). Emissione laterale della luce, 30.000 ore di durata CRI>80.

*Flexible led strip, silicone cover, installation with mounting kit (included). Lateral light emission, 30,000 hours of life CRI>80.*



## Flex

VERSIONE VERSION	LED's/m LED's/m	POTENZA POWER	CODICE CODE	COLORE COLOUR	OTTICA OPTICS
PLUS	96	7,7 W	ERS009	<input type="checkbox"/> C 5000°K <input type="checkbox"/> W 2700°K	



# Ribbon RGB



Strip LED flessibile, installazione rapida tramite banda adesiva, taglio su misura, personalizzazione eseguibile dal cliente, 30.000 ore di durata

Flexible led strip, quick installation using adhesive strip, custom cut, self-customisable, 30,000 hours of life.

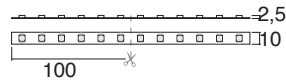

## Ribbon RGB

VERSIONE VERSION	LED's/m LED's/m	POTENZA POWER	CODICE CODE	COLORE COLOR
HI-FLUX 	60	14,4 W	ERS001	 Z RGB

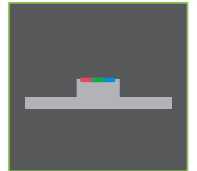

# RGB Controller + wireless Remote



Potenza - Power	216W
Carico collegabile in uscita - Max connectable output load	15m RGB strip
Tensione nominale di ingresso - Nominal input voltage	24 V DC
Tensione nominale di uscita - Nominal output voltage	24 V
Corrente nominale in uscita - Nominal output current	3 (x3 channels) A
Efficienza nominale - Nominal efficiency	95 %
Temperatura max. sul contenitore - Max housing temperature	50°
Temperatura d'esercizio - Operating temperature	-20°C...+50°C
Sezione cavi primario - Primary cables gauge	1,5 mm <sup>2</sup>
Sezione cavi secondario - Secondary cables gauge	1,5 mm <sup>2</sup>
Peso - Weight	140 g

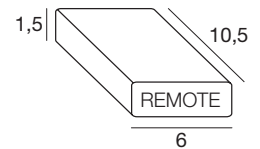

CODICE  
CODE  
**ERD015**





# Strip Profiles Info

**SLIM** PROFILO ESTRUSO RETTANGOLARE IN ALLUMINIO 6060 ANODIZZATO GRIGIO.  
**SLIM** EXTRUDED RECTANGULAR PROFILE IN GREY ANODIZED ALUMINIUM 6060.



CODICE  
CODE  
**ERA051**

Copertura in policarbonato opale o trasparente  
*Opal or transparent polycarbonate cover*

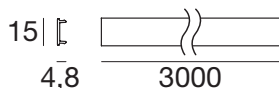

FINITURA FINISH	CODICE CODE
Opaline	<b>ERA065</b>
Transp.	<b>ERA093</b>

Kit di chiusura laterale per profilo estruso SLIM  
*SLIM extruded profile side closing kit*



CODICE KIT  
KIT CODE  
**ERA052**

Kit di assemblaggio ad incastro per profilo estruso SLIM  
*SLIM extruded profile interlocking assembly kit*

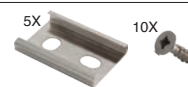

CODICE KIT  
KIT CODE  
**ERA053**

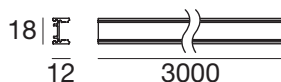

**HID SLIM** PROFILO ESTRUSO RETTANGOLARE IN ALLUMINIO 6060 ANODIZZATO GRIGIO CON BATTUTA E ALETTE DI FISSAGGIO LATERALI.  
**HID SLIM** EXTRUDED RECTANGULAR PROFILE IN GREY ANODIZED ALUMINIUM 6060 WITH STOP AND LATERAL MOUNTING FINNS.



CODICE  
CODE  
**ERA054**

Copertura in policarbonato opale o trasparente  
*Opal or transparent polycarbonate cover*

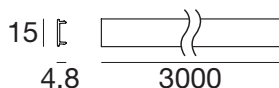

FINITURA FINISH	CODICE CODE
Opaline	<b>ERA065</b>
Transp.	<b>ERA093</b>

Kit di chiusura laterale per profilo estruso HID SLIM  
*HID SLIM extruded profile side closing kit*



CODICE KIT  
KIT CODE  
**ERA055**



**COOPER** PROFILO ESTRUSO TRIANGOLARE IN ALLUMINIO 6060 ANODIZZATO GRIGIO PER APPLICAZIONE STRIP E PLAFONI SU ANGOLI 90°.  
**COOPER** EXTRUDED TRIANGULAR PROFILE IN GREY ANODIZED ALUMINIUM 6060 FOR STRIP AND SURFACE APPLICATIONS ON 90° ANGLES.

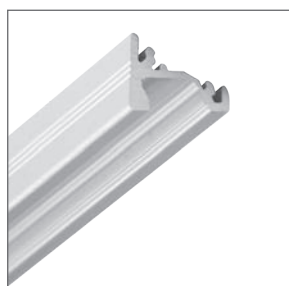

CODICE  
CODE  
**ERA095**

Copertura in policarbonato opale o trasparente  
*Opal or transparent polycarbonate cover*

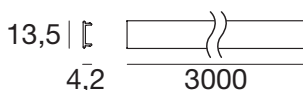

FINITURA FINISH	CODICE CODE
Opaline	<b>ERA096</b>

Kit di chiusura laterale per profilo estruso COOPER  
*COOPER extruded profile side closing kit*



CODICE KIT  
KIT CODE  
**ERA097**

Kit di assemblaggio ad incastro per profilo estruso COOPER  
*COOPER extruded profile interlocking assembly kit*



CODICE KIT  
KIT CODE  
**ERA098**

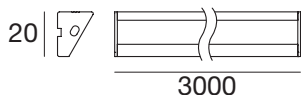

**KAMPAS** PROFILO ESTRUSO TRIANGOLARE RAGGIATO IN ALLUMINIO 6060 ANODIZZATO GRIGIO PER APPLICAZIONE STRIP E PLAFONI SU ANGOLI 90°.  
**KAMPAS** *ROUNDED TRIANGULAR PROFILE IN GREY ANODIZED ALUMINIUM 6060 FOR STRIP AND SURFACE APPLICATIONS ON 90° ANGLES.*



CODICE  
CODE  
**ERA056**

Copertura in policarbonato opale  
*Opal polycarbonate cover*

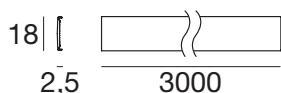

FINITURA  
FINISH  
Opaline

CODICE  
CODE  
**ERA066**

Kit di chiusura laterale per profilo estruso KAMPAS  
*KAMPAS extruded profile side closing kit*



CODICE KIT  
KIT CODE  
**ERA057**

Kit di assemblaggio ad incastro per profilo estruso KAMPAS  
*KAMPAS extruded profile interlocking assembly kit*



CODICE KIT  
KIT CODE  
**ERA058**

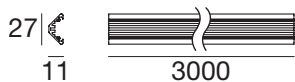

**VEGAN** PROFILO ESTRUSO RETTANGOLARE RAGGIATO IN ALLUMINIO 6060 ANODIZZATO GRIGIO PER APPLICAZIONE STRIP A PLAFONE.  
**VEGAN** *ROUNDED RECTANGULAR PROFILE IN GREY ANODIZED ALUMINIUM 6060 FOR STRIP SURFACE APPLICATIONS.*



CODICE  
CODE  
**ERA062**

Copertura in policarbonato opale  
*Opal polycarbonate cover*

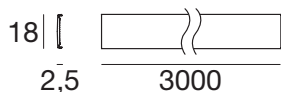

FINITURA  
FINISH  
Opaline

CODICE  
CODE  
**ERA066**

Kit di chiusura laterale per profilo estruso VEGAN  
*VEGAN extruded profile side closing kit*

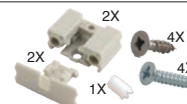

CODICE KIT  
KIT CODE  
**ERA063**

Kit di assemblaggio ad incastro per profilo estruso VEGAN  
*VEGAN extruded profile interlocking assembly kit*



CODICE KIT  
KIT CODE  
**ERA064**

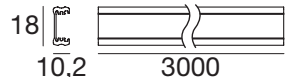

**LAMPAS** PROFILO ESTRUSO RETTANGOLARE RAGGIATO IN ALLUMINIO 6060 ANODIZZATO GRIGIO PER APPLICAZIONE STRIP A PLAFONE.  
**LAMPAS** *ROUNDED RECTANGULAR PROFILE IN GREY ANODIZED ALUMINIUM 6060 FOR STRIP SURFACE APPLICATIONS.*



CODICE  
CODE  
**ERA059**

Copertura in policarbonato opale  
*Opal polycarbonate cover*

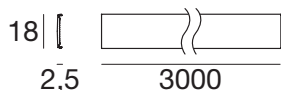

FINITURA  
FINISH  
Opaline

CODICE  
CODE  
**ERA066**

Kit di chiusura laterale per profilo estruso LAMPAS  
*LAMPAS extruded profile side closing kit*



CODICE KIT  
KIT CODE  
**ERA060**

Kit di assemblaggio ad incastro per profilo estruso LAMPAS  
*LAMPAS extruded profile interlocking assembly kit*

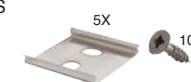

CODICE KIT  
KIT CODE  
**ERA061**

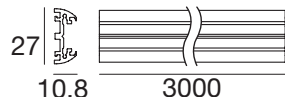











# BATHROOM SOLUTIONS

Lampade dal design minimale realizzate per applicazioni su specchi. Gamma di lampade con elevato grado IP per l'ambiente d'applicazione. La lampada GIADA è la prima con diffusore personalizzabile nella sua forma e nelle dimensioni.

*Minimal design lamps made for application on mirrors. This range of lights has a high IP grade for the application environment. The GIADA lamp is the first with a diffuser that can be customised in shape and dimension.*

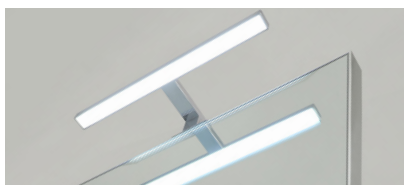

Annie page 132



Alice page 132



Nova page 133



Bianca page 133



Amanda page 134



Giada page 134



Info page 135

# Annie



Corpo in ABS cromato e copertura opalina. Doppia possibilità d'installazione: a ridosso con staffa o a morsa tramite grani filettati. Alimentazione integrata per collegamento diretto alla rete elettrica.

*Fixture with chromium ABS frame and opal cover. Double installation option: with bracket or with threaded grub grip. Built-in power supply for direct connection to mains power.*

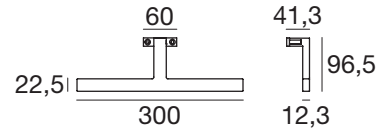

## Annie

FINITURA FINISH	L. →	kg	LED's LED's	POTENZA POWER	CODICE CODE	COLORE COLOUR	OTTICA OPTICS
Chrome	300 mm	0,16	21	5 W	ER1272	<input type="checkbox"/> N 4000°K	<input checked="" type="checkbox"/> 0

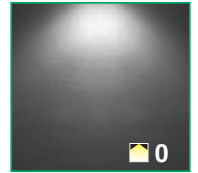

# Alice



Corpo in alluminio cromato molto sottile e dalla forma armonioso, installazione a ridosso della specchiera. Linea di luce continua uniforme priva di punti.

*Very thin chromium-plated aluminium body with harmonious shape, close surface installation on the mirror. Uniform continuous light lines with point-free effect.*

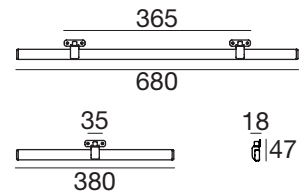

Alice PLUS			Alice TOP			COLORE COLOUR	OTTICA OPTICS	
FINITURA FINISH	L. →	kg	LED's LED's	POTENZA POWER	CODICE CODE	LED's LED's	POTENZA POWER	CODICE CODE
Chrome	380 mm	0,20	42	3,4 W	ER0806	84	6,7 W	ER0807
	680 mm	0,31	78	6,2 W	ER0809	156	12,5 W	ER0810
White	380 mm	0,20	42	3,4 W	ER0959	84	6,7 W	ER0960
	680 mm	0,31	78	6,2 W	ER0962	156	12,5 W	ER0963

COLORE COLOUR	OTTICA OPTICS
<input checked="" type="checkbox"/> C 5000°K	<input checked="" type="checkbox"/> 0
<input type="checkbox"/> N 4000°K	
<input type="checkbox"/> W 2700°K	

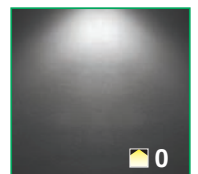

# Nova



Corpo in alluminio cromato o verniciato bianco, installazione a ridosso della specchiera. Diffusore opalino in policarbonato, 30.000 ore di durata.

*Chromium-plated or white painted aluminium body, close surface installation on the mirror. Opal polycarbonate diffuser, 30,000 hours of life.*

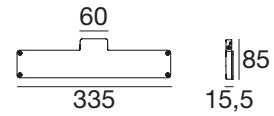

FINITURA FINISH		Nova PLUS			Nova TOP			COLORE COLOUR		OTTICA OPTICS
FINITURA FINISH	kg	LED's LED's	POTENZA POWER	CODICE CODE	LED's LED's	POTENZA POWER	CODICE CODE	COLORE COLOUR	OTTICA OPTICS	
Chrome	0,40	108	8,6 W	ER0553	216	17,3 W	ER0554	C 5000°K	0	
White				ER0643			ER0644	N 4000°K		
							W 2700°K			

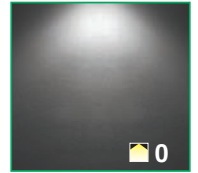

# Bianca



Profilo lineare in policarbonato opalino, linea di luce continua e uniforme, circuito SMD ad altissima efficienza. Doppia staffa nel profilo da 510mm, singola staffa nel profilo da 380mm. Driver incluso da posizionare dietro la specchiera

*Opal polycarbonate linear profile, continuous and uniform light emission, high efficiency SMD circuit. Double brackets in the 510mm profile, single bracket in the 380mm profile. Driver included to be mounted behind the mirror.*

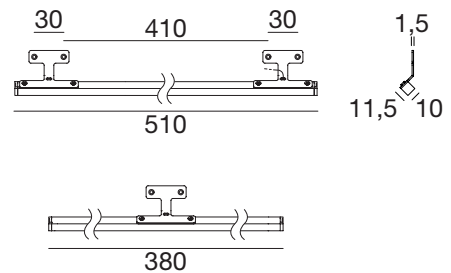

FINITURA FINISH		L.	Bianca			COLORE COLOUR		OTTICA OPTICS
FINITURA FINISH	kg	L.	LED's LED's	POTENZA POWER	CODICE CODE	COLORE COLOUR	OTTICA OPTICS	
Opaline	0,7	380 mm	30	4,4 W	ER1212	C 5000°K	0	
		510 mm	90	6 W	ER1210	N 4000°K		
	0,12					W 3000°K		

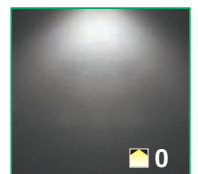



# Amanda



Profilo lineare in policarbonato opalino, linea di luce continua e uniforme, circuito SMD ad altissima efficienza. Doppia lunghezza del profilo da 450mm o da 700mm. Driver incluso da posizionare dietro la specchiera.

*Opal polycarbonate linear profile, continuous and uniform light emission, high efficiency SMD circuit. Double profile length, 450 mm or 700 mm. Driver included to be mounted behind the mirror.*

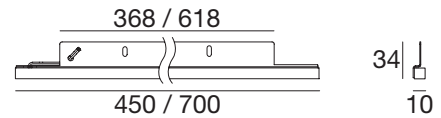

## Amanda

FINITURA FINISH	L. →	kg	LED's LED's	POTENZA POWER	CODICE CODE	COLORE COLOUR	OTTICA OPTICS
Opaline	450 mm	0,9	78	5,2 W	ER1266	<input checked="" type="checkbox"/> C 5000°K <input type="checkbox"/> N 4000°K <input type="checkbox"/> W 3000°K	<input checked="" type="checkbox"/> 0
	700 mm	0,15	120	8 W	ER1267		<input type="checkbox"/> 0

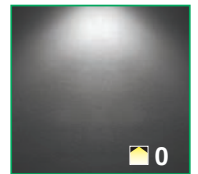

# Giada

diffusore personalizzabile nella forma  
*customizable diffuser shape*



Profilo in alluminio anodizzato, diffusore personalizzabile in PMMA laserizzato, trama incisa a laser. Installazione a ridosso nella specchiera tramite viti. Comfort visivo elevato.

*Anodized aluminium profile, laser-cut PMMA customisable diffuser, laser-engraved pattern. Close surface mounting on mirror using screws. High quality light emission.*

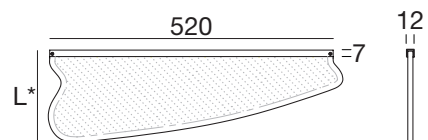

\* Dimensione personalizzabile, forma del diffusore indicativa

*\* Customizable dimension, the diffuser form shown is indicative*

## Giada

FINITURA FINISH	L. →	kg	LED's LED's	POTENZA POWER	CODICE CODE	COLORE COLOUR	OTTICA OPTICS
Opaline	Custom	-	90	6 W	ER1211	<input checked="" type="checkbox"/> C 5000°K <input type="checkbox"/> N 4000°K <input type="checkbox"/> W 3000°K	<input checked="" type="checkbox"/> 0



Info personalizzazione del diffusore a pagina 118  
*Info to customize the diffuser at page 118*

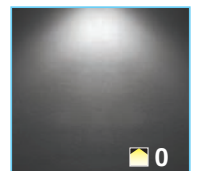

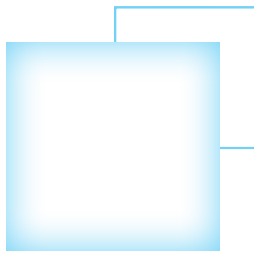

# LASER LIGHT GUIDE SYSTEM

personalizzazione GIADA  
GIADA customisation

SISTEMA OTTICO INNOVATIVO  
INNOVATIVE OPTICS SYSTEM



L'innovativa tecnologia LASER LIGHT GUIDE SYSTEM garantisce comfort visivo elevato, ottima efficienza energetica e la libertà di poter personalizzare il diffusore della lampada GIADA. Il pannello in PMMA spesso 4mm, incredibilmente trasparente, viene lavorato grazie ad una speciale trama incisa a laser che ottimizza il convogliamento e la distribuzione dell'emissione luminosa.

*The innovative LASER LIGHT SYSTEM technology guarantees high visual comfort, outstanding energy efficiency and the freedom to customise the diffuser of the GIADA fixture. The 4 mm thick PMMA panel, incredibly transparent, is processed using a special laser-engraved pattern which optimises light emission channelling and distribution.*

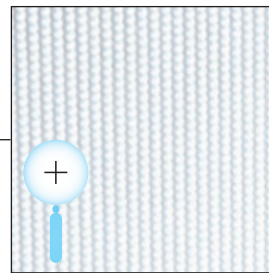
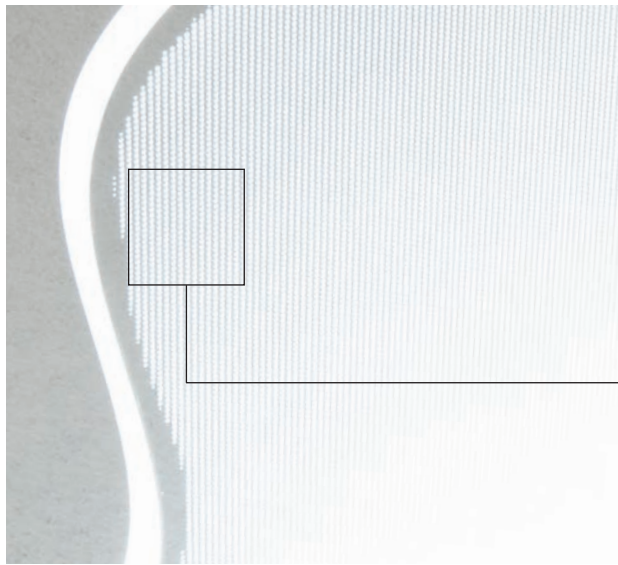

PERSONALIZZAZIONE GIADA  
GIADA CUSTOMISATION

Possibilità a richiesta di personalizzare la forma e la dimensione del diffusore in PMMA, per di più è possibile fotoincidere tramite tecnologia LASER LIGHT GUIDE SYSTEM i propri loghi aziendali, scritte e grafiche a piacere.

*The shape and dimension of the PMMA diffuser can be customised on request. The LASER LIGHT GUIDE SYSTEM technology can also be used to create photogravure of your own corporate logo, text and graphics.*



ESEMPIO DI FOTOINCISIONE PERSONALIZZATA  
EXAMPLE OF CUSTOM PHOTOGRAVURE

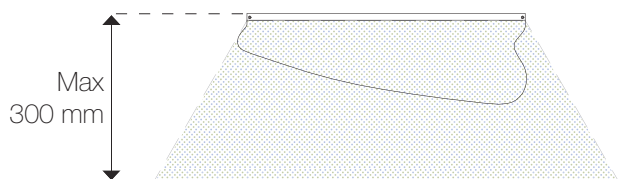











# ELECTRONICS SUPPLIES SENSOR & ACCESSORIES

LINEA LIGHT GROUP sviluppa una serie completa di alimentatori, sensori e controllori LED per la gestione dei prodotti LIVIN'LIGHT. Con alimentatori in CC o in CV garantiamo un miglioramento dell'efficienza dell'impianto e un aumento considerevole dei risparmi energetici. Ulteriore risparmio viene dato dall'utilizzo di sensori i quali automatizzano l'accensione con il rilevamento di spostamenti, movimenti o presenze.

*LINEA LIGHT GROUP has developed a complete set of drivers, sensors and LED controllers to manage LIVIN'LIGHT products. With CC or CV drivers, we guarantee system efficiency and a substantial increase of energy savings. Further savings is provided by using sensors which automate the switching using motion or presence detection.*



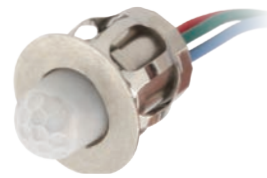
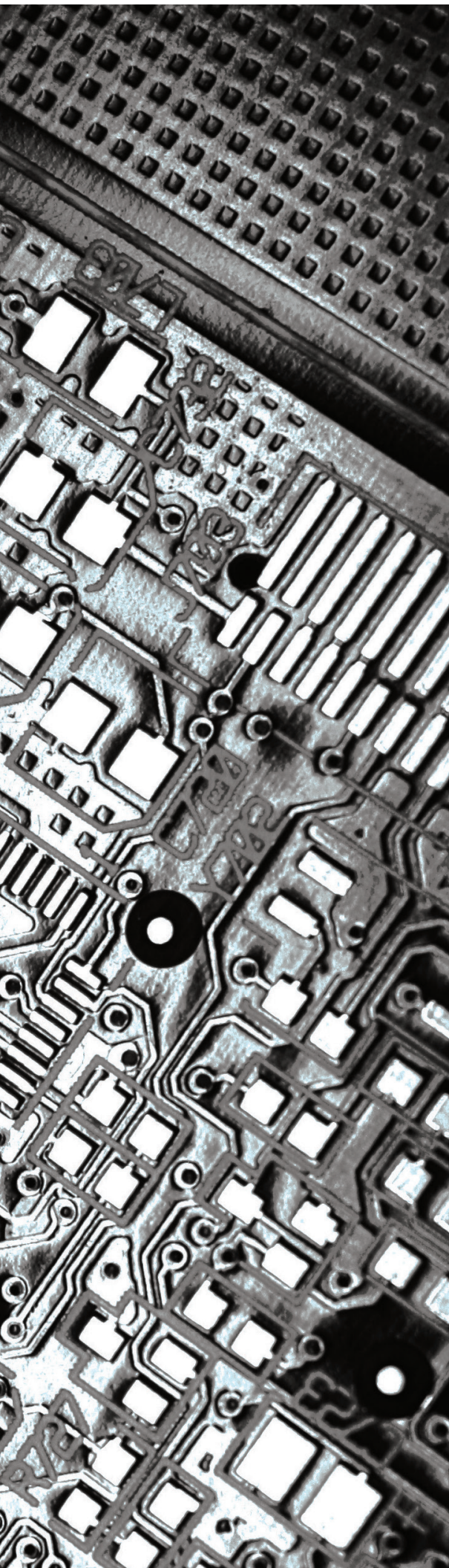

Sensors page 140



Cables page 142

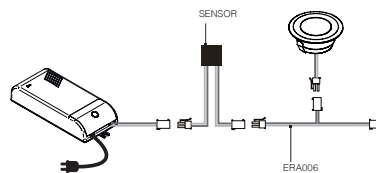

Wiring page 143

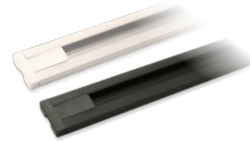

Mark page 144



CC drivers page 146



CV drivers page 150

# Sensors Info

## Ir on/off dimmer CV-CC



Corpo in nylon nero, Installazione ad incasso. L'accensione e lo spegnimento avviene passando la mano nei pressi del sensore (ad una distanza max. 50 mm), possibilità di dimmerare la luce (stazionando la mano in prossimità del sensore).

*Circular body made of black nylon, recessed installation. Switching on and off takes place by passing a hand near the sensor (max distance 50mm), possibility of dimming the light (holding your hand close to the sensor).*



### Ir on/off dimmer

FINITURA FINISH	VERSIONE VERSION	kg	POSIZIONE POSITION	CODICE CODE
Black	CV	0,59	Ad incasso Recessed	ERA073
	CC			ERA074

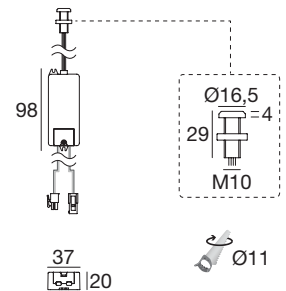

## Ir switch sensor



Corpo in nylon nero o bianco per installazione ad incasso o a ridosso. Doppia funzione per il controllo dell'articolo: impostando la funzione "touch" l'accensione avviene passando la mano in prossimità del sensore. Impostando la funzione "door" accensione e spegnimento avvengono con apertura/chiusura dell'anta del mobile.

*Black or white nylon body for recessed or close surface installation. Dual switching feature: setting the "touch" function, switching on takes place by passing a hand near the sensor. Setting the "door" function, switching on and off takes place with the opening/closing of a door.*



### Ir switch sensor

FINITURA FINISH	VERSIONE VERSION	kg	POSIZIONE POSITION	CODICE CODE
Black	CV	0,59	Ad incasso o a ridosso	ERA091
White			Recessed or surface	ERA092

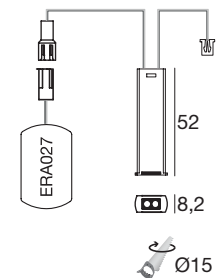

## Remote on/off dimmer



Dispositivo per il controllo e la dimerazione di Strip LED mono colore. Al suo interno incorpora una scheda a un canale per pilotare fino a 96W di strip LED. Il telecomando ha un controllo RF wireless (distanza massima 20m).

*Single colour LED strip control and dimming device. Inside, it incorporates a one-channel board to drive up to 96W of LED strip. The remote control is wireless RF (20 m maximum distance).*

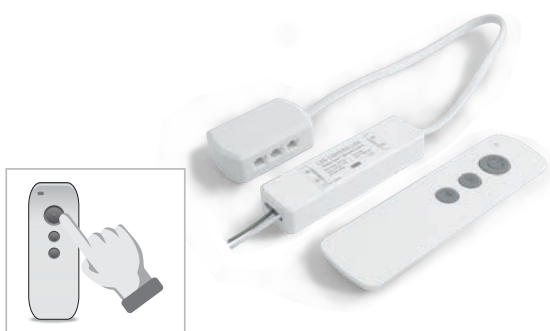

### LED controller

FINITURA FINISH	VERSIONE VERSION	kg	CODICE CODE
White	CV	0,06	ERA094

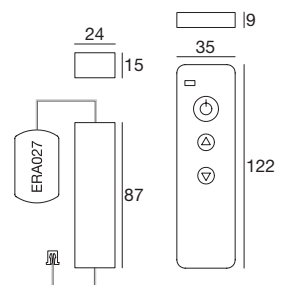

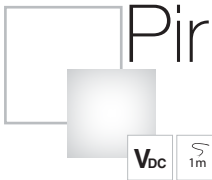

# Pir



Sensore di presenza PIR, corpo in nylon in nero o bianco. Adatto a installazione ad incasso o a ridosso. Accensione a rilevamento di movimento, spegnimento dopo 30" dal rilevamento.

*PIR presence detector, black or white nylon body. Recessed or surface installation. Switching on by motion detection, switches off 30" after detection.*



## Pir

FINITURA FINISH	VERSIONE VERSION	kg	POSIZIONE POSITION	CODICE CODE
White	CV	0,59	Ad incasso o a ridosso	ERA099
Black			Recessed or surface	ERA100

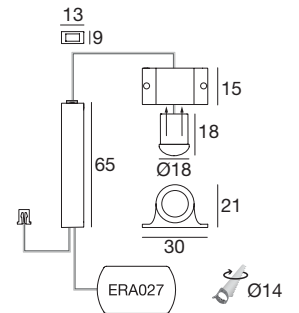

# Pir\_pro



Sensore di presenza PIR, corpo in ottone, installazione ad incasso con molla (inclusa). Accensione a rilevamento di movimento, collegamento con attacco rapido.

*Infrared presence sensor (PIR), brass body, recessed installation with spring (included). Switches on with presence detection, connection with quick connector.*

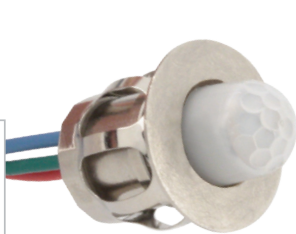

## Pir

FINITURA FINISH	VERSIONE VERSION	kg	POSIZIONE POSITION	CODICE CODE
White	CV	0,15	Ad incasso Recessed	ERA047
Chrome				ERA081
Nickel				ERA082

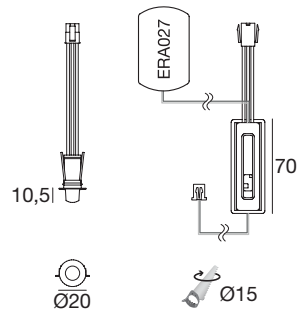

# On / Off



Interruttore meccanico in materiale plastico con finitura nera. Installazione ad incasso, dimensioni ridotte, facile e veloce collegamento elettrico.

*Mechanical switch made of plastic material with black finish. Recessed installation, small size, easy and quick electrical connection.*



## On / Off

FINITURA FINISH	VERSIONE VERSION	kg	POSIZIONE POSITION	CODICE CODE
Black	CC	0,04	Ad incasso Recessed	ERA016

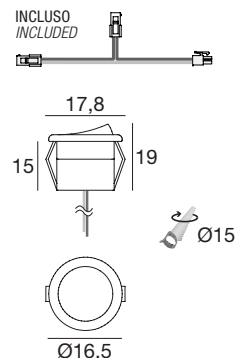



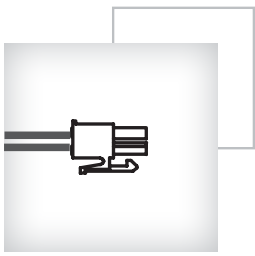

# Cables



Ciabatta per connessione rapida di max 6 articoli con STRIP  
*Quick connection adapter for max 6 STRIP products*

L.	CODICE CODE
300 mm	<b>ERA027</b>



Cavo per connessione multipla  
*Multi-connection cable*

L.	CODICE CODE
200 mm	<b>ERA006</b>



Cavo parallelo  
*Parallel cable*

L.	CODICE CODE
200 mm	<b>ERA046</b>



Prolunga power LED  
*LED power extension*

L.	CODICE CODE
1000 mm	<b>ERA008</b>



Cavo cablaggio strip  
*Strip wiring cable*

L.	CODICE CODE
2000 mm	<b>ERA067</b>



Prolunga strip led  
*LED strip extension*

L.	CODICE CODE
3000 mm	<b>ERA044</b>

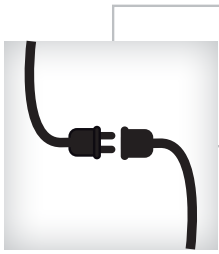

# Wiring

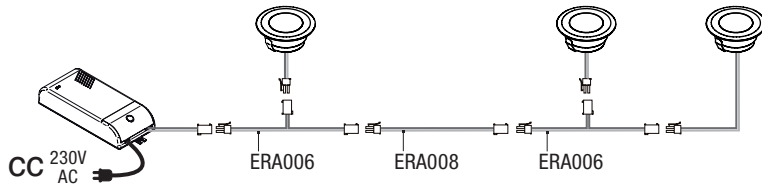

Esempio di collegamento di più spot in serie e prolunga.

*Connection example of multiple spotlights in series with extension.*

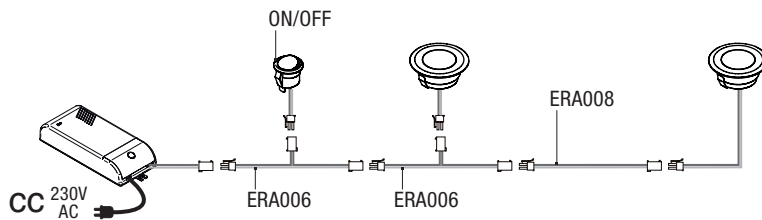

Esempio di collegamento di più spot in serie con eventuale interruttore on/off e prolunghie.

*Connection example of multiple spotlights in series with on/off switch and extensions.*

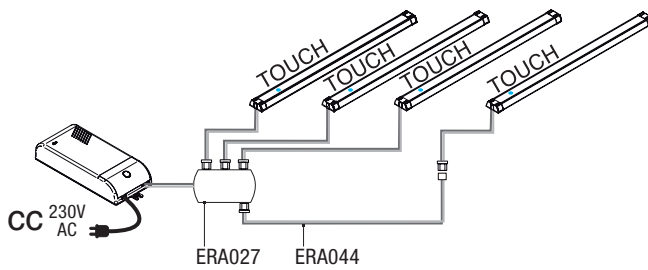

Esempio di collegamento di più profili con sensore TOUCH integrato e prolunga.

*Connection example of multiple profiles with TOUCH sensor integrated and extension.*

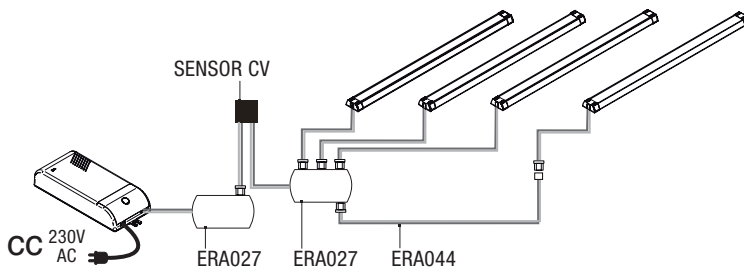

Esempio di collegamento di più profili con sensore remoto e prolunga.

*Connection example of multiple profiles with remote sensor and extension.*



Sono raffigurati alcuni esempi di cablaggio, su richiesta eseguiamo cablaggi su specifica del cliente con cavi e connettori custom

*Some wiring examples are depicted. On request, we carry wiring based on the customer's specifications with custom cables and connectors*

# Mark Info

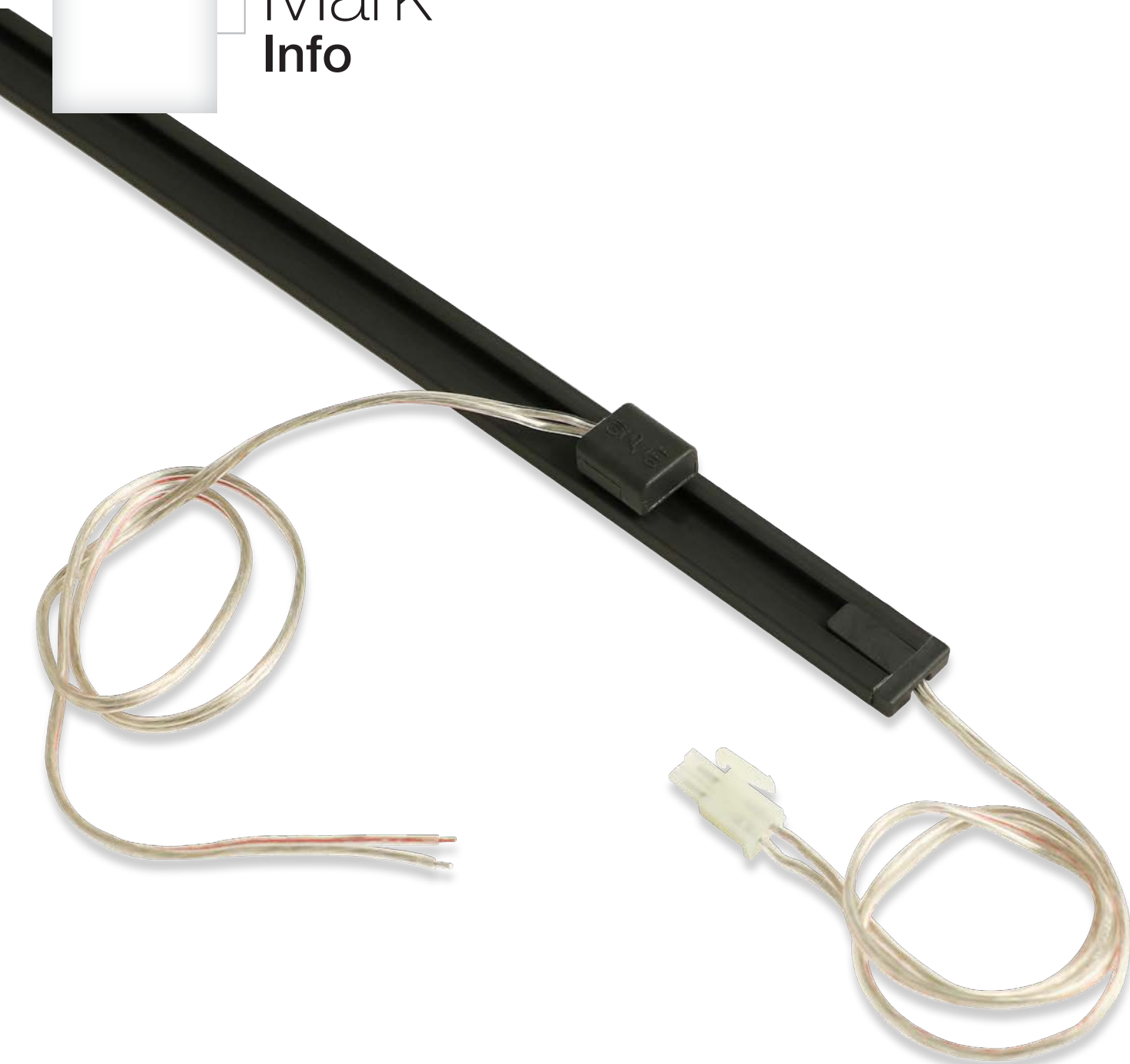

## Descrizione Description

Binario elettrificato in bassa tensione disponibile in due finiture nero antracite e bianco, connettore rapido della stessa finitura del binario con innesto rapido per collegamento cavo dedicato e connessione al binario con possibilità di essere spostato a seconda delle esigenze, ideale per scaffalature.

*Low voltage electrified track available in black anthracite or white finish, quick connector in the same finish as the track with quick coupling to connect the dedicated cable and connection to the track that can be moved based on requirements, ideal for shelving.*



Binario elettrificato / connettori  
Electrified track / connector



FINITURA FINISH	L.	kg	CODICE CODE
White	2 m	0,4	ERA101
Anthracite			ERA102

Binario elettrificato in bassa tensione con biadesivo. Completo di testata e cavo per alimentazione da 2m.

Low voltage electrified track with double-sided adhesive tape. Cable for 2m power supply.

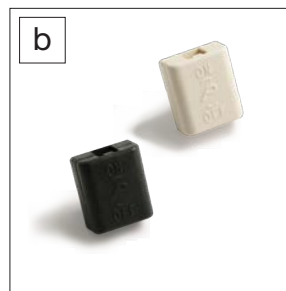
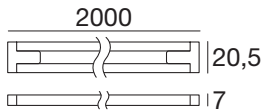

FINITURA FINISH	CODICE CODE
White	ERA103
Anthracite	ERA104

Connettore in plastica con innesto per cavo specifico.

Plastic connector with specific cable connection.

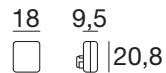

Cavi  
Cables

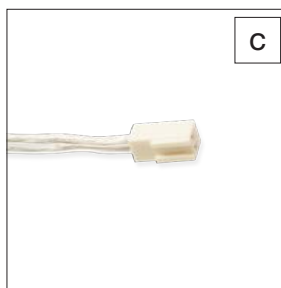

CODICE CODE
ERA105

Cavo connessione per profili LED con innesto per connettore Mark da 630mm.

Connection cable for Driver with output cable connection at the Mark track, 630mm length.

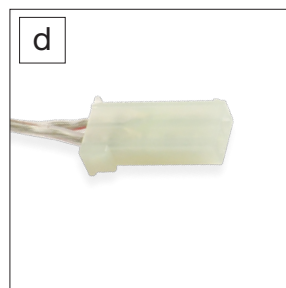

CODICE CODE
ERA106

Cavo connessione per Driver con innesto al cavo in uscita dal binario Mark da 300mm.

Connection cable for Driver with connection to the cable at the Mark track, 300mm length.

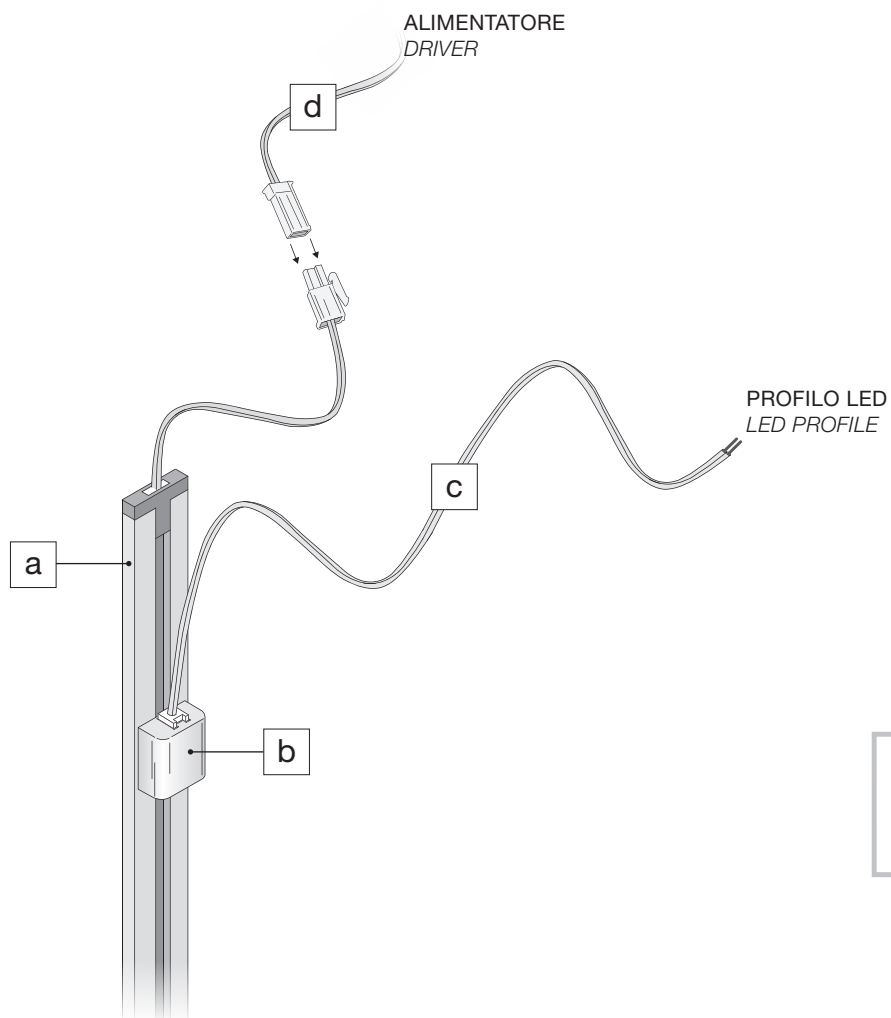





# CC Driver

Gamma di alimentatori a corrente costante per il collegamento di articoli dotati di power LED con correnti: 220mA, 350mA e 630mA da collegare in serie mediante gli appositi accessori di cablaggio.

Connettore Plug incluso. Cavo e spina per connessione alla rete inclusi.

**SmartWave** technology: ottima efficienza, lunga durata operativa, protezione ai surge elevato PF. Protezione contro le sovratemperature, il sovraccarico, il circuito aperto ed il circuito lungo la linea in uscita.

*Range of constant current drivers for the connection of products that have LED power with the following power: 220mA, 350mA and 630mA, to connect in series using suitable wiring accessories.*

*Plug connector included. Cable and plug for mains connection included.*

**SmartWave** technology: high efficiency, long operating time, high PF surge protection. Protection against overheating, overloading, open circuits and the circuit along the output line.

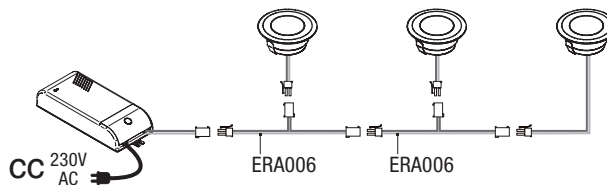

SMARTWAVE

## Driver 1-2 LEDs

### 220mA



Potenza - Power	2W
Carico collegabile in uscita - Max. connectable output load	1-2 LEDs 1W
Tensione nominale di ingresso - Nominal input voltage	190 / 250 V AC
Frequenza - Frequency	50 / 60 Hz
Corrente di ingresso - Nominal input current	0,05 A
Tensione di uscita - Output voltage	17-40 V
Corrente nominale di uscita - Nominal output current	220 ± 10% mA
Fattore di potenza - Power factor	0,6 C
Temp. max sul contenitore Tc - Max housing temp.	70°C
Temperatura d'esercizio - Operating temperature	-40°C 50°C
Peso - Weight	45 g

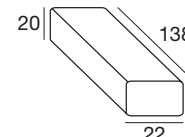

CODICE  
CODE

**ERD038**

## Driver 6-12 LEDs

### 220mA



Potenza - Power	8W
Carico collegabile in uscita - Max. connectable output load	6-12 LEDs 1W
Tensione nominale di ingresso - Nominal input voltage	180 / 300 V AC
Frequenza - Frequency	50 / 60 Hz
Corrente di ingresso - Nominal input current	0,11 A
Tensione di uscita - Output voltage	17-40 V
Corrente nominale di uscita - Nominal output current	220 ± 10% mA
Fattore di potenza - Power factor	0,9 C
Temp. max sul contenitore Tc - Max housing temp.	70°C
Temperatura d'esercizio - Operating temperature	-40°C 50°C
Peso - Weight	72 g

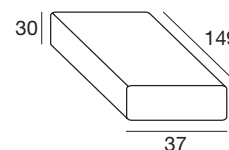

CODICE  
CODE

**ERD040**

# Driver 1-2 LEDs

350mA



Potenza - Power	3W
Carico collegabile in uscita - Max. connectable output load	1-2 LEDs 1W
Tensione nominale di ingresso - Nominal input voltage	190 / 250 V AC
Frequenza - Frequency	50 / 60 Hz
Corrente di ingresso - Nominal input current	0,05 A
Tensione di uscita - Output voltage	8 V
Corrente nominale di uscita - Nominal output current	350 ± 10% mA
Fattore di potenza - Power factor	0,6 C
Temp. max sul contenitore Tc - Max housing temp.	70°C
Temperatura d'esercizio - Operating temperature	-40°C 50°C
Peso - Weight	45 g

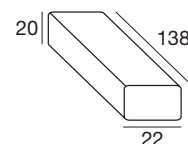

CODICE  
CODE

**ERD009**

# Driver 3-6 LEDs

350mA



Potenza - Power	7W
Carico collegabile in uscita - Max. connectable output load	3-6 LEDs 1W
Tensione nominale di ingresso - Nominal input voltage	190 / 250 V AC
Frequenza - Frequency	50 / 60 Hz
Corrente di ingresso - Nominal input current	0,05 A
Tensione di uscita - Output voltage	21 V
Corrente nominale di uscita - Nominal output current	350 ± 10% mA
Fattore di potenza - Power factor	0,6 C
Temp. max sul contenitore Tc - Max housing temp.	70°C
Temperatura d'esercizio - Operating temperature	-40°C 50°C
Peso - Weight	45 g

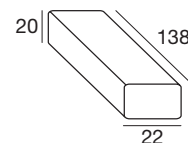

CODICE  
CODE

**ERD004**

# Driver 6-12 LEDs

350mA



Potenza - Power	12W
Carico collegabile in uscita - Max. connectable output load	6-12 LEDs 1W
Tensione nominale di ingresso - Nominal input voltage	180 / 300 V AC
Frequenza - Frequency	50 / 60 Hz
Corrente di ingresso - Nominal input current	0,11 A
Tensione di uscita - Output voltage	17-40 V
Corrente nominale di uscita - Nominal output current	350 ± 10% mA
Fattore di potenza - Power factor	0,9 C
Temp. max sul contenitore Tc - Max housing temp.	70°C
Temperatura d'esercizio - Operating temperature	-40°C 50°C
Peso - Weight	72 g

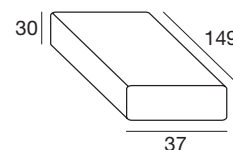

CODICE  
CODE

**ERD046**

# Driver 1-2 LEDs

630mA



Potenza - Power	5W
Carico collegabile in uscita - Max. connectable output load	1-2 LEDs 2W
Tensione nominale di ingresso - Nominal input voltage	190 / 250 V AC
Frequenza - Frequency	50 / 60 Hz
Corrente di ingresso - Nominal input current	0,05 A
Tensione di uscita - Output voltage	11 V
Corrente nominale di uscita - Nominal output current	600 ± 10% mA
Fattore di potenza - Power factor	0,6 C
Temp. max sul contenitore Tc - Max housing temp.	70°C
Temperatura d'esercizio - Operating temperature	-40°C 50°C
Peso - Weight	45 g

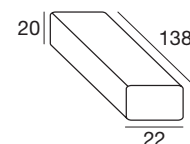

CODICE  
CODE  
**ERD010**

# Driver 3-6 LEDs

630mA



Potenza - Power	12W
Carico collegabile in uscita - Max. connectable output load	3-6 LEDs 2W
Tensione nominale di ingresso - Nominal input voltage	180 / 300 V AC
Frequenza - Frequency	50 / 60 Hz
Corrente di ingresso - Nominal input current	0,11 A
Tensione di uscita - Output voltage	9-20 V
Corrente nominale di uscita - Nominal output current	630 ± 10% mA
Fattore di potenza - Power factor	0,9 C
Temp. max sul contenitore Tc - Max housing temp.	70°C
Temperatura d'esercizio - Operating temperature	-40°C 50°C
Peso - Weight	72 g

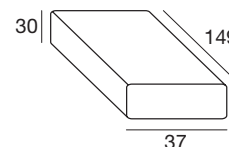

CODICE  
CODE  
**ERD047**

# Driver 6-12 LEDs

630mA



Potenza - Power	24W
Carico collegabile in uscita - Max. connectable output load	6-12 LEDs 2W
Tensione nominale di ingresso - Nominal input voltage	180 / 300 V AC
Frequenza - Frequency	50 / 60 Hz
Corrente di ingresso - Nominal input current	0,15 A
Tensione di uscita - Output voltage	17-40 V
Corrente nominale di uscita - Nominal output current	630 ± 10% mA
Fattore di potenza - Power factor	0,9 C
Temp. max sul contenitore Tc - Max housing temp.	70°C
Temperatura d'esercizio - Operating temperature	-40°C 50°C
Peso - Weight	94 g

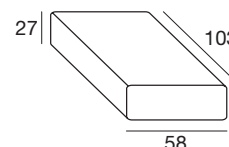

CODICE  
CODE  
**ERD048**

LINEAL LIGHT, con la sua divisione elettronica, progetta e sviluppa internamente i sistemi di alimentazione. Adottando elevati standard di qualità, garantisce un prodotto che possa realmente supportare la lunga durata del LED nel tempo

*LINEA LIGHT designs and develops its products in-house. Therefore, in addition to providing 'Made in Italy' production, we design and develop our own drivers in our electronics department, ensuring high quality standards, and guaranteeing high quality performance and long life for our LED lighting products*

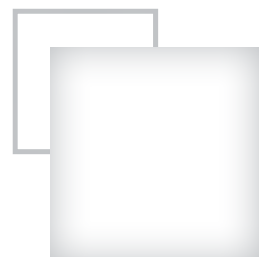
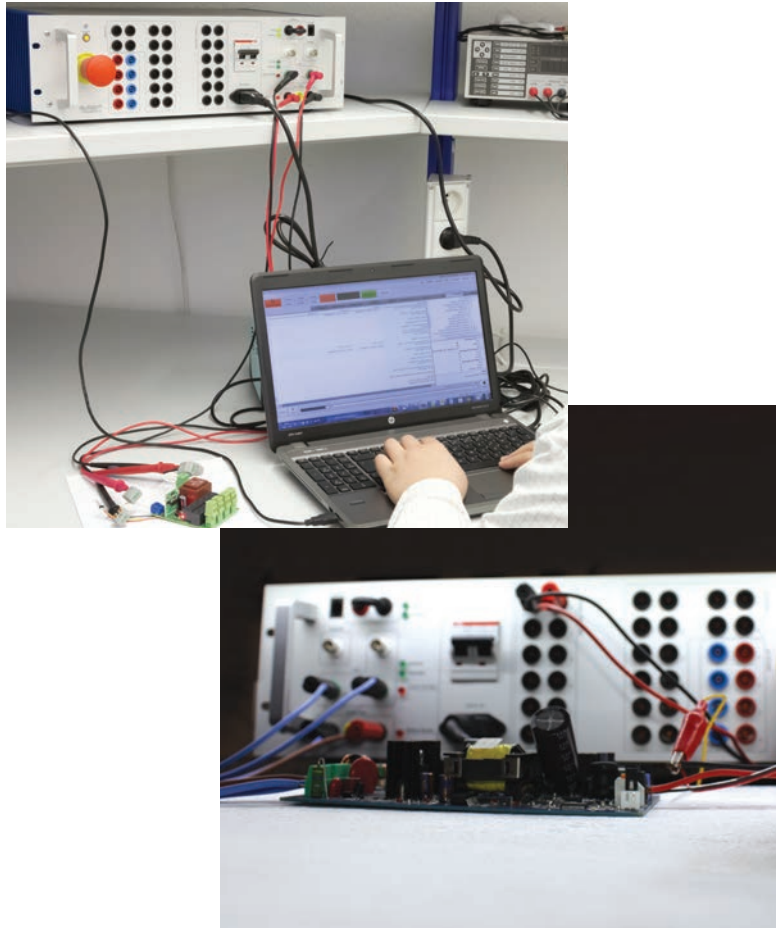



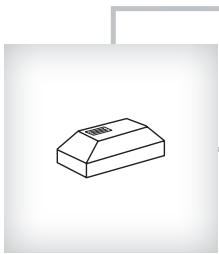

# CV Driver

Gamma di alimentatori a tensione costante 24V, adatti ad alimentare strip LED e articoli con circuiti SMD. Disponibili in diverse potenze e dimensioni, garantiscono una migliore integrazione nel mobile grazie ad ingombri ridotti.

Ciabatta per connessione rapida a 6 ingressi inclusa.

Cavo e spina per connessione alla rete inclusi.

Range of 24V constant current drivers, ideal for powering LED strips and products with SMD circuits. Available in various power and size versions, they guarantee better integration in the furniture with reduced bulk.

Quick connection adapter with 6 inputs included.

Cable and plug for mains connection included.

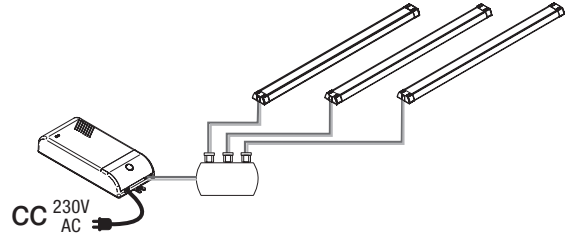

## Driver 6W



Potenza - Power	6W
Tensione nominale di ingresso - Nominal input voltage	200 / 240 V AC
Frequenza - Frequency	50 Hz
Corrente di ingresso - Nominal input current	0,25 A
Tensione di uscita - Output voltage	24 V
Corrente nominale di uscita - Nominal output current	0,350 A max
Fattore di potenza - Power factor	> 0,5 C
Efficienza nominale - Nominal efficiency	80%
Temp. max sul contenitore Tc - Max housing temp.	80°C
Temperatura d'esercizio - Operating temperature	-10°C...+45°C
Peso - Weight	63 g

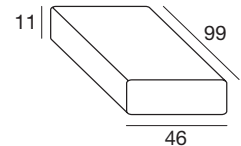

CODICE  
CODE  
**ERD030**

## Driver 15W



Potenza - Power	15W
Tensione nominale di ingresso - Nominal input voltage	200 / 240 V AC
Frequenza - Frequency	50 Hz
Corrente di ingresso - Nominal input current	0,15 A
Tensione di uscita - Output voltage	24 V
Corrente nominale di uscita - Nominal output current	0,625 A max
Fattore di potenza - Power factor	> 0,5 C
Efficienza nominale - Nominal efficiency	80%
Temp. max sul contenitore Tc - Max housing temp.	80°C
Temperatura d'esercizio - Operating temperature	-10°C...+45°C
Peso - Weight	74 g

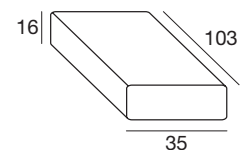

CODICE  
CODE  
**ERD006**

# Driver 30W



Potenza - Power	30W
Tensione nominale di ingresso - Nominal input voltage	200 / 240 V AC
Frequenza - Frequency	50 Hz
Corrente di ingresso - Nominal input current	0,2 A
Tensione di uscita - Output voltage	24 V
Corrente nominale di uscita - Nominal output current	1,25 A max
Fattore di potenza - Power factor	0,9 C
Efficienza nominale - Nominal efficiency	86%
Temp. max sul contenitore Tc - Max housing temp.	85°C
Temperatura d'esercizio - Operating temperature	-10°C...+45°C
Peso - Weight	156 g

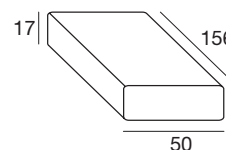

CODICE  
CODE

**ERD008**

# Driver 50W 24V DC



Potenza - Power	50W
Tensione nominale di ingresso - Nominal input voltage	200 / 240 V AC
Frequenza - Frequency	50 Hz
Corrente di ingresso - Nominal input current	0,25 A
Tensione di uscita - Output voltage	24 V
Corrente nominale di uscita - Nominal output current	2,08 A max
Fattore di potenza - Power factor	> 0,9 C
Efficienza nominale - Nominal efficiency	86%
Temp. max sul contenitore Tc - Max housing temp.	80°C
Temperatura d'esercizio - Operating temperature	-10°C...+45°C
Peso - Weight	244 g

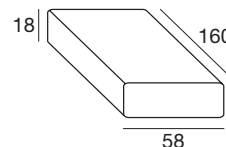

CODICE  
CODE

**ERD012**

# Driver 75W 24V DC



Potenza - Power	75W
Tensione nominale di ingresso - Nominal input voltage	200 / 240 V AC
Frequenza - Frequency	50 Hz
Corrente di ingresso - Nominal input current	0,4 A
Tensione di uscita - Output voltage	24 V
Corrente nominale di uscita - Nominal output current	3,12 A max
Fattore di potenza - Power factor	0,9 C
Efficienza nominale - Nominal efficiency	86%
Temp. max sul contenitore Tc - Max housing temp.	80°C
Temperatura d'esercizio - Operating temperature	-10°C...+45°C
Peso - Weight	310 g

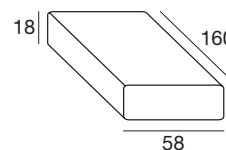

CODICE  
CODE

**ERD019**

# Driver 15W



Potenza - Power	15W
Tensione nominale di ingresso - Nominal input voltage	110 V AC
Frequenza - Frequency	50 Hz
Corrente di ingresso - Nominal input current	0,15 A
Tensione di uscita - Output voltage	24 V
Corrente nominale di uscita - Nominal output current	0,625 A max
Fattore di potenza - Power factor	> 0,5 C
Efficienza nominale - Nominal efficiency	80%
Temp. max sul contenitore Tc - Max housing temp.	75°C
Temperatura d'esercizio - Operating temperature	-10°C...+45°C
Peso - Weight	74 g

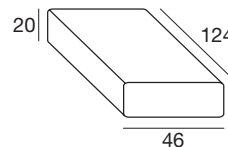

CODICE  
CODE  
**ERD024**

# Driver 30W



Potenza - Power	30W
Tensione nominale di ingresso - Nominal input voltage	110 V AC
Frequenza - Frequency	50 Hz
Corrente di ingresso - Nominal input current	0,2 A
Tensione di uscita - Output voltage	24 V
Corrente nominale di uscita - Nominal output current	1,25 A max
Fattore di potenza - Power factor	0,9 C
Efficienza nominale - Nominal efficiency	86%
Temp. max sul contenitore Tc - Max housing temp.	85°C
Temperatura d'esercizio - Operating temperature	-10°C...+45°C
Peso - Weight	156 g

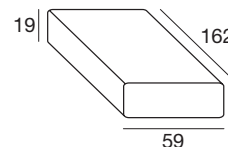

CODICE  
CODE  
**ERD029**

# Driver 50W



Potenza - Power	50W
Tensione nominale di ingresso - Nominal input voltage	110-240 V AC
Frequenza - Frequency	50/60 Hz
Corrente di ingresso - Nominal input current	0,55(110V) 0,2A(240V)
Tensione di uscita - Output voltage	24 V
Corrente nominale di uscita - Nominal output current	2 A max
Fattore di potenza - Power factor	> 0,9 C
Efficienza nominale - Nominal efficiency	89%
Temp. max sul contenitore Tc - Max housing temp.	80°C
Temperatura d'esercizio - Operating temperature	-10°C...+45°C
Peso - Weight	244 g

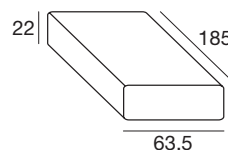

CODICE  
CODE  
**ERD032**

# Driver 75W



Potenza - Power	75W
Tensione nominale di ingresso - Nominal input voltage	100-240 V AC
Frequenza - Frequency	50/60 Hz
Corrente di ingresso - Nominal input current	0,85(110V) 0,4A(240V)
Tensione di uscita - Output voltage	24 V
Corrente nominale di uscita - Nominal output current	2 A max
Fattore di potenza - Power factor	> 0,9 C
Efficienza nominale - Nominal efficiency	89%
Temp. max sul contenitore Tc - Max housing temp.	80°C
Temperatura d'esercizio - Operating temperature	-10°C...+45°C
Peso - Weight	310 g

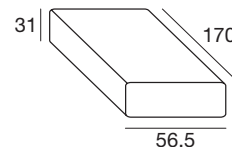

CODICE  
CODE  
**ERD033**

# Driver 100W



Potenza - Power	100W
Tensione nominale di ingresso - Nominal input voltage	100-240 V AC
Frequenza - Frequency	50/60 Hz
Corrente di ingresso - Nominal input current	1,1(110V) 0,5A(240V)
Tensione di uscita - Output voltage	24 V
Corrente nominale di uscita - Nominal output current	2 A max
Fattore di potenza - Power factor	> 0,9 C
Efficienza nominale - Nominal efficiency	89%
Temp. max sul contenitore Tc - Max housing temp.	80°C
Temperatura d'esercizio - Operating temperature	-10°C...+45°C
Peso - Weight	323 g

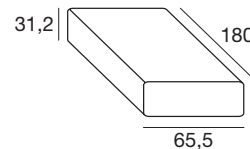

CODICE  
CODE  
**ERD034**



CODICE  
CODE  
**ERD049**



# GLOSSARY

CODICE CODE	PAGINA PAGE	CODICE CODE	PAGINA PAGE
ER0042	115	ER0240	117
ER0043	115	ER0241	117
ER0044	115	ER0242	117
ER0045	115	ER0243	117
ER0046	115	ER0244	117
ER0047	115	ER0245	117
ER0048	115	ER0246	117
ER0049	115	ER0299	82
ER0054	117	ER0300	82
ER0056	117	ER0317	51
ER0057	117	ER0318	51
ER0083	82	ER0319	51
ER0084	82	ER0320	51
ER0085	82	ER0321	51
ER0102	98	ER0322	51
ER0103	98	ER0323	51
ER0104	98	ER0324	51
ER0105	98	ER0362	50
ER0107	82	ER0363	50
ER0108	82	ER0364	50
ER0109	82	ER0365	50
ER0177	50	ER0366	51
ER0178	50	ER0367	51
ER0179	50	ER0368	51
ER0180	50	ER0369	51
ER0182	34	ER0375	34
ER0183	34	ER0376	34
ER0184	34	ER0377	34
ER0185	34	ER0378	34
ER0187	50	ER0388	83
ER0188	50	ER0389	83
ER0189	50	ER0390	83
ER0190	50	ER0391	83
ER0192	34	ER0393	83
ER0193	34	ER0394	83
ER0194	34	ER0395	83
ER0195	34	ER0396	83
ER0214	116	ER0418	82
ER0215	116	ER0419	82
ER0219	116	ER0420	82
ER0220	116	ER0421	82
ER0228	116	ER0422	83
ER0229	116	ER0423	83
ER0230	116	ER0424	83
ER0231	116	ER0425	83
ER0239	117	ER0475	20

CODICE CODE	PAGINA PAGE
ER0476	20
ER0477	20
ER0478	20
ER0480	20
ER0481	20
ER0482	20
ER0483	20
ER0485	20
ER0486	20
ER0487	20
ER0488	20
ER0501	22
ER0502	22
ER0503	22
ER0504	22
ER0505	22
ER0506	22
ER0507	22
ER0508	22
ER0509	22
ER0510	22
ER0511	22
ER0512	22
ER0514	66
ER0515	66
ER0516	66
ER0517	66
ER0519	66
ER0520	66
ER0521	66
ER0522	66
ER0524	66
ER0525	66
ER0526	66
ER0527	66
ER0540	68
ER0541	68
ER0542	68
ER0543	68
ER0544	68
ER0545	68
ER0546	68
ER0547	68
ER0548	68
ER0549	68
ER0550	68
ER0551	68
ER0553	133
ER0554	133
ER0570	56
ER0571	56
ER0572	56
ER0573	56
ER0574	56

CODICE CODE	PAGINA PAGE
ER0575	56
ER0576	56
ER0577	56
ER0578	56
ER0579	56
ER0580	56
ER0581	56
ER0594	22
ER0595	22
ER0596	22
ER0597	22
ER0598	22
ER0599	22
ER0600	22
ER0601	22
ER0602	22
ER0603	22
ER0604	22
ER0605	22
ER0606	67
ER0607	67
ER0608	67
ER0609	67
ER0610	67
ER0611	67
ER0612	67
ER0613	67
ER0614	67
ER0615	67
ER0616	67
ER0617	67
ER0618	21
ER0619	21
ER0620	21
ER0621	21
ER0622	21
ER0623	21
ER0624	21
ER0625	21
ER0626	21
ER0627	21
ER0628	21
ER0629	21
ER0630	66
ER0631	66
ER0632	66
ER0633	66
ER0634	66
ER0635	66
ER0636	66
ER0637	66
ER0638	66
ER0639	66
ER0640	66

CODICE CODE	PAGINA PAGE
ER0641	66
ER0643	133
ER0644	133
ER0651	92
ER0652	92
ER0653	92
ER0654	92
ER0655	92
ER0656	92
ER0657	92
ER0658	92
ER0659	92
ER0660	92
ER0661	92
ER0662	92
ER0676	20
ER0677	20
ER0678	20
ER0679	20
ER0681	20
ER0682	20
ER0683	20
ER0684	20
ER0686	20
ER0687	20
ER0688	20
ER0689	20
ER0690	23
ER0691	23
ER0692	23
ER0693	23
ER0694	23
ER0695	23
ER0696	23
ER0697	23
ER0698	23
ER0699	23
ER0700	23
ER0701	23
ER0702	23
ER0703	23
ER0704	23
ER0705	23
ER0706	23
ER0707	23
ER0708	34
ER0709	34
ER0710	34
ER0711	34
ER0712	34
ER0713	34
ER0714	34
ER0715	34
ER0716	34

CODICE CODE	PAGINA PAGE
ER0717	34
ER0718	34
ER0719	34
ER0720	50
ER0721	50
ER0722	50
ER0723	50
ER0724	50
ER0725	50
ER0726	50
ER0727	50
ER0728	50
ER0729	50
ER0730	50
ER0731	50
ER0783	82
ER0784	82
ER0785	82
ER0786	82
ER0787	82
ER0788	82
ER0789	82
ER0790	82
ER0791	82
ER0792	82
ER0793	82
ER0794	82
ER0795	60
ER0796	60
ER0797	60
ER0798	60
ER0799	60
ER0800	60
ER0801	60
ER0802	60
ER0803	60
ER0804	60
ER0806	132
ER0807	132
ER0809	132
ER0810	132
ER0812	28
ER0813	28
ER0814	28
ER0815	28
ER0817	28
ER0818	28
ER0819	28
ER0820	28
ER0822	28
ER0823	28
ER0824	28
ER0825	28
ER0838	28

CODICE CODE	PAGINA PAGE
ER0839	28
ER0840	28
ER0841	28
ER0842	28
ER0843	28
ER0844	28
ER0845	28
ER0846	28
ER0847	28
ER0848	28
ER0849	28
ER0850	86
ER0851	86
ER0852	86
ER0853	86
ER0854	86
ER0855	86
ER0856	86
ER0857	86
ER0858	86
ER0859	86
ER0860	86
ER0861	86
ER0862	88
ER0863	88
ER0864	88
ER0865	88
ER0866	88
ER0867	88
ER0868	88
ER0869	88
ER0870	88
ER0871	88
ER0872	88
ER0873	88
ER0874	87
ER0875	87
ER0876	87
ER0877	87
ER0878	87
ER0879	87
ER0880	87
ER0881	87
ER0882	87
ER0883	87
ER0884	87
ER0885	87
ER0886	86
ER0887	86
ER0888	86
ER0889	86
ER0890	86
ER0891	86
ER0892	86

CODICE CODE	PAGINA PAGE	CODICE CODE	PAGINA PAGE	CODICE CODE	PAGINA PAGE	CODICE CODE	PAGINA PAGE	CODICE CODE	PAGINA PAGE	CODICE CODE	PAGINA PAGE	CODICE CODE	PAGINA PAGE
ER0893	86	ER1046	12	ER1114	21	ER1168	51	ER1222	16	ERA027	142	ERD032	152
ER0894	86	ER1047	12	ER1115	21	ER1169	51	ER1223	16	ERA044	142	ERD033	153
ER0895	86	ER1048	110	ER1116	21	ER1170	51	ER1224	16	ERA046	142	ERD034	153
ER0896	86	ER1049	110	ER1117	21	ER1171	51	ER1225	16	ERA047	141	ERD038	146
ER0897	86	ER1050	110	ER1118	21	ER1172	51	ER1226	16	ERA051	126	ERD040	146
ER0959	132	ER1051	110	ER1119	21	ER1173	51	ER1227	16	ERA052	126	ERD046	147
ER0960	132	ER1052	110	ER1120	21	ER1174	67	ER1228	16	ERA053	126	ERD047	148
ER0962	132	ER1053	110	ER1121	21	ER1175	67	ER1229	16	ERA054	126	ERD048	148
ER0963	132	ER1054	110	ER1122	21	ER1176	67	ER1230	40	ERA055	126	ERD049	153
ER0974	118	ER1055	110	ER1123	21	ER1177	67	ER1231	40	ERA056	127	ERS001	122
ER0975	118	ER1056	110	ER1124	21	ER1178	67	ER1232	40	ERA057	127	ERS001	124
ER0976	118	ER1057	110	ER1125	21	ER1179	67	ER1233	40	ERA058	127	ERS002	122
ER0977	118	ER1058	110	ER1126	29	ER1180	67	ER1234	40	ERA059	127	ERS003	123
ER0978	118	ER1059	110	ER1127	29	ER1181	67	ER1235	40	ERA060	127	ERS004	122
ER0979	118	ER1060	110	ER1128	29	ER1182	67	ER1236	40	ERA061	127	ERS005	122
ER0980	118	ER1061	110	ER1129	29	ER1183	67	ER1237	40	ERA062	127	ERS006	123
ER0981	118	ER1062	110	ER1130	29	ER1184	67	ER1238	40	ERA063	127	ERS007	122
ER0995	114	ER1063	110	ER1131	29	ER1185	67	ER1239	40	ERA064	127	ERS008	122
ER0999	107	ER1064	110	ER1132	29	ER1186	87	ER1240	40	ERA065	126	ERS009	123
ER1000	106	ER1065	110	ER1133	29	ER1187	87	ER1241	40	ERA066	127	ERS010	122
ER1012	118	ER1066	110	ER1134	29	ER1188	87	ER1242	40	ERA067	142	ERS011	72
ER1013	118	ER1067	110	ER1135	29	ER1189	87	ER1243	40	ERA072	106		
ER1014	118	ER1068	110	ER1136	29	ER1190	87	ER1244	40	ERA072	107		
ER1015	118	ER1069	110	ER1137	29	ER1191	87	ER1245	40	ERA073	140		
ER1016	118	ER1070	110	ER1138	35	ER1192	87	ER1246	40	ERA074	140		
ER1017	118	ER1071	110	ER1139	35	ER1193	87	ER1247	40	ERA081	141		
ER1018	118	ER1072	110	ER1140	35	ER1194	87	ER1248	40	ERA082	141		
ER1019	118	ER1073	110	ER1141	35	ER1195	87	ER1249	40	ERA091	140		
ER1020	44	ER1074	110	ER1142	35	ER1196	87	ER1250	40	ERA092	140		
ER1021	44	ER1075	110	ER1143	35	ER1197	87	ER1251	40	ERA093	126		
ER1022	44	ER1076	110	ER1144	35	ER1198	83	ER1252	40	ERA094	140		
ER1023	44	ER1077	110	ER1145	35	ER1199	83	ER1253	40	ERA095	126		
ER1024	44	ER1078	110	ER1146	35	ER1200	83	ER1254	41	ERA096	126		
ER1025	44	ER1079	110	ER1147	35	ER1201	83	ER1255	41	ERA097	126		
ER1026	44	ER1080	110	ER1148	35	ER1202	83	ER1256	41	ERA098	126		
ER1027	44	ER1081	110	ER1149	35	ER1203	83	ER1257	41	ERA099	141		
ER1028	44	ER1082	110	ER1150	45	ER1204	83	ER1258	41	ERA100	141		
ER1029	44	ER1083	110	ER1151	45	ER1205	83	ER1259	41	ERA101	145		
ER1030	44	ER1092	29	ER1152	45	ER1206	83	ER1260	41	ERA102	145		
ER1031	44	ER1093	29	ER1153	45	ER1207	83	ER1261	41	ERA103	145		
ER1032	44	ER1094	29	ER1154	45	ER1208	83	ER1262	41	ERA104	145		
ER1033	44	ER1095	29	ER1155	45	ER1209	83	ER1263	41	ERA105	145		
ER1034	44	ER1096	29	ER1156	45	ER1210	133	ER1264	41	ERA106	145		
ER1035	44	ER1097	29	ER1157	45	ER1211	134	ER1265	41	ERD004	147		
ER1036	44	ER1098	29	ER1158	45	ER1212	133	ER1266	134	ERD006	150		
ER1037	44	ER1099	29	ER1159	45	ER1213	106	ER1267	134	ERD008	151		
ER1038	44	ER1100	29	ER1160	45	ER1214	78	ER1268	78	ERD009	147		
ER1039	44	ER1101	29	ER1161	45	ER1215	78	ER1269	78	ERD010	148		
ER1040	44	ER1102	29	ER1162	51	ER1216	78	ER1270	78	ERD012	151		
ER1041	44	ER1103	29	ER1163	51	ER1217	78	ER1271	78	ERD015	124		
ER1042	44	ER1104	12	ER1164	51	ER1218	102	ER1272	132	ERD019	151		
ER1043	44	ER1106	12	ER1165	51	ER1219	102	ERA006	142	ERD024	152		
ER1044	12	ER1108	12	ER1166	51	ER1220	102	ERA008	142	ERD029	152		
ER1045	12	ER1110	12	ER1167	51	ER1221	102	ERA016	141	ERD030	150		

# linea light address

## Linea Light HQ Italy

via della Fornace, 59 z.i.  
31023 Castelfranco di Resana (TV) - Italy  
Phone: +39 0423 7868  
Fax: +39 0423 786900  
info@linealight.com

## LightVillage Milano

Exhibition Area Only  
via Morimondo, 26 int. 17G  
20143 Milano - Italy  
Phone: +39 02 36750915  
Fax: +39 02 36750915  
milano@lightvillage.it

## Linea Light Roma

Via Stendhal, 22  
00144 Roma - Italy  
Phone: +39 06 5935106  
info@linealightroma.com

## Linea Light UK

Suite 109 - Business Design Centre  
52 Upper Street - Islington N10QH  
London - UK  
Phone: +44 0203 6371983  
info@linealight-uk.com

## Linea Light France

Z.A. Heiden Est, 12 rue des Pays-Bas  
68310 Wittelsheim - France  
Phone: +33 389 75 52 23  
Fax: +33 389 75 59 07  
info@linealight.fr

## Linea Light Deutschland

Aktienstraße 214  
45473 Mülheim a.d. Ruhr - Germany  
Phone: +49 208 299979-0  
Fax: +49 208 299979-10  
service@linealight.de

## Linea Light Polska

ul. Wiosenna, 47  
41253 Czeladz - Poland  
Phone: +48 32 760 98 71  
Fax: +48 32 760 98 76  
biuro@linealight.com.pl

## Linea Light Russia

105120, Moscow, Russia  
Nizhnaya Syromyatnicheskaya st. 10 bl2,  
office 7.3/1  
Phone: +7 495 639 99 41  
info@linealight.ru

## Linea Light Spain

C/ Longares, 48  
28022 Madrid - Spain  
Phone: +34 653 881 578  
info@linealight.es

## Linea Light USA - Inter Lux

3741 Commerce Drive  
Suites 306-308  
Baltimore, MD 21227 - USA  
Phone: +1 410 381 1497  
Fax: +1 410 381 1589  
answers@inter-lux.com

## Linea Light GCC

Jumeirah Lake Towers  
JBC2 - 35th Floor Office 02 - Dubai - UAE  
P.O. Box 125902  
Phone: +971 4 4218275  
Fax: +971 4 4218274  
info@linealight.ae

## Linea Light Asia - Pacific

N.7 Nanyi Huayuan Road Industry Avenue  
528478 Xiaolan Town - Zhongshan City  
Guangdong Province - China  
Phone: +86 760 87618355  
Fax: +86 760 87553990  
info@linealight.cn

## Linea Light Singapore

21 Kaki Bukit Place, 5th Fl.  
Eunos Techpark Singapore  
416199 Singapore  
Phone: +65-6908 5758  
info.sg@linealight.com

## Art direction

Linea Light Group Marketing Dept.

## Printed in Italy

January 2020

"Linealight Group" si riserva il diritto, senza alcun preavviso di modificare le caratteristiche dei propri prodotti come la disponibilità degli stessi in qualunque momento. Tutti i prodotti, relativi dati tecnici, illustrazioni e informazioni presenti sul catalogo non sono vincolanti per "Linealight Group". "Linealight Group" non risponderà di eventuali errori illustrativi, testuali e/o di traduzione. Ulteriori caratteristiche dei prodotti sono contenute nelle relative schede tecniche e fogli istruzioni. Il presente catalogo è tutelato dalla legge sui diritti d'autore (legge 22/04/1941 n. 633 e della legge 14/12/1942 n. 1485: di esso è proibita ogni riproduzione totale o anche parziale). Tutti i valori riportati a catalogo sono valori di misurazione. I dati di flusso, CCT e potenza sono passibili di tolleranze di +/- 10 %. I disegni, le quote, i materiali ed i colori del presente catalogo si intendono a titolo indicativo. Nell'interesse della clientela, l'Azienda si riserva il diritto di modificare i modelli in ogni momento senza l'obbligo di preavviso. L'indicazione della bandiera italiana nel presente catalogo è puramente indicativa. I prodotti potrebbero avere origine diversa da quanto indicato.

"Linea Light Group" reserves the right, without any advance notice, to change the characteristics of their products, as well as the availability of the same at any time. No product, relative technical data, illustrations and information in the catalogue are binding for "Linea Light Group". "Linea Light Group" will not be held liable for any illustration, text and/or translation errors. More product characteristics are contained in the relative technical data sheets and instruction sheets. This catalogue is protected by copyright (law 22/04/1941 No. 633 and law 14/12/1942 No. 1485: this prohibits any reproduction, total or even partial). All values indicated in the catalogue are measured values. There is a +/- 10% tolerance for the flow, CCT and power data. The drawings, the measurements, the materials and the colours in this catalogue are understood to be indicative. In the interest of the clientele, the company reserves the right to modify the models at any time and without any obligation of advance notice. The indication of the Italian flag in this catalogue is purely indicative. The products could be of origins other than those indicated.